

SECOND EDITION
Rapid Visual Screening of
Buildings for Potential
Seismic Hazards:
A Handbook

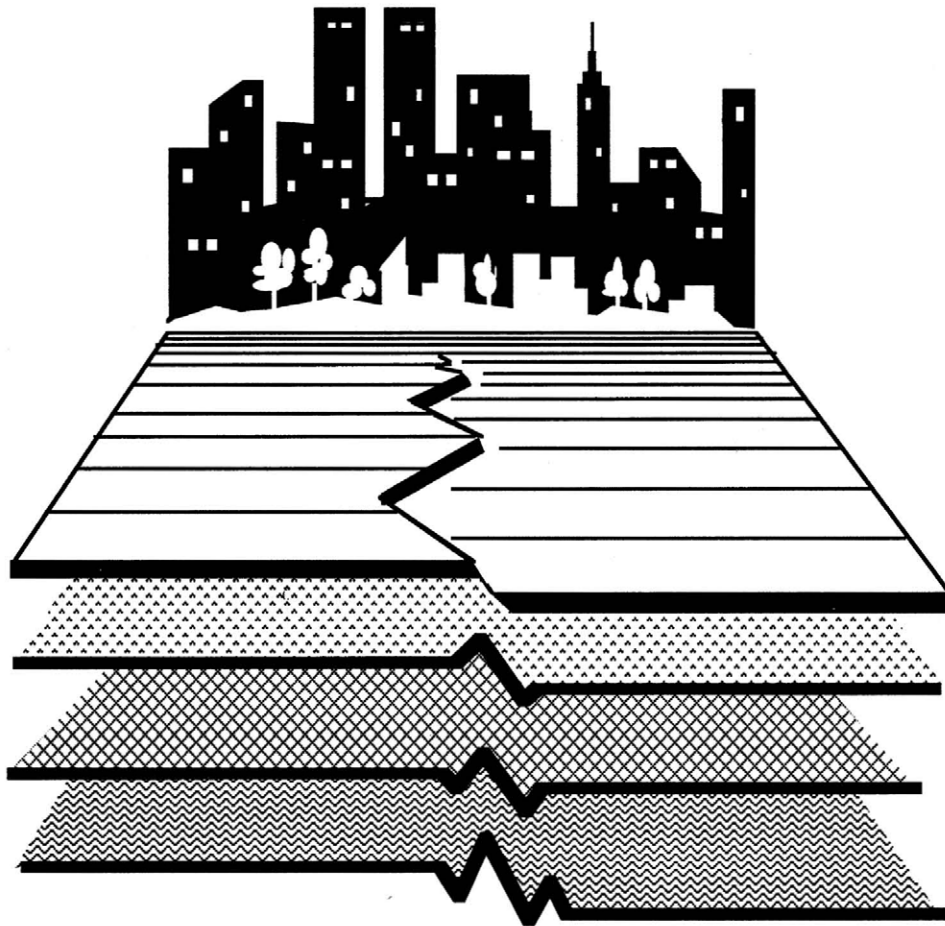

FEMA Foreword

The Federal Emergency Management Agency (FEMA) is pleased to present the second edition of the widely used *Rapid Visual Screening of Buildings for Potential Seismic Hazards: A Handbook*, and its companion, *Supporting Documentation*. The policy of improving reports and manuals that deal with the seismic safety of existing buildings as soon as new information and adequate resources are available is thus being reaffirmed. Users should take note of some major differences between the two editions of the *Handbook*. The technical content of the new edition is based more on experiential data and less on expert judgment than was the case in the earlier edition, as is explained in the *Supporting Documentation*. From the presentational point of view, the *Handbook* retains much of the material of the earlier edition, but the material has been rather thoroughly rearranged to further facilitate the step-by-step process of conducting the rapid visual screening of a building. By far the most significant difference between the two editions,

however, is the need for a higher level of engineering understanding and expertise on the part of the users of the second edition. This shift has been caused primarily by the difficulty experienced by users of the first edition in identifying the lateral-force-resisting system of a building without entry—a critical decision of the rapid visual screening process. The contents of the *Supporting Documentation* volume have also been enriched to reflect the technical advances in the *Handbook*.

FEMA and the Project Officer wish to express their gratitude to the members of the Project Advisory Panel, to the technical and workshop consultants, to the project management, and to the report production and editing staff for their expertise and dedication in the upgrading of these two volumes.

The Federal Emergency Management Agency

Preface

In August 1999 the Federal Emergency Management Agency (FEMA) awarded the Applied Technology Council (ATC) a two-year contract to update the FEMA 154 report, *Rapid Visual Screening of Buildings for Potential Seismic Hazards: A Handbook*, and the companion FEMA-155 report, *Rapid Visual Screening of Buildings for Potential Seismic Hazards: Supporting Documentation*, both of which were originally published in 1988.

The impetus for the project stemmed in part from the general recommendation in the FEMA 315 report, *Seismic Rehabilitation of Buildings: Strategic Plan 2005*, to update periodically all existing reports in the FEMA-developed series on the seismic evaluation and rehabilitation of existing buildings. In addition, a vast amount of information had been developed since 1988, including: (1) new knowledge about the performance of buildings during damaging earthquakes, including the 1989 Loma Prieta and 1994 Northridge earthquakes; (2) new knowledge about seismic hazards, including updated national seismic hazard maps published by the U. S. Geological Survey in 1996; (3) other new seismic evaluation and damage prediction tools, such as the FEMA 310 report, *Handbook for the Seismic Evaluation of Buildings – a Prestandard*, (an updated version of FEMA 178, *NEHRP Handbook for the Seismic Evaluation of Existing Buildings*), and HAZUS, FEMA’s tool for estimating potential losses from natural disasters; and (4) experience from the widespread use of the original FEMA 154 *Handbook* by federal, state and municipal agencies, and others.

The project included the following tasks: (1) an effort to obtain users feedback, which was executed through the distribution of a voluntary FEMA 154 Users Feedback Form to organizations that had ordered or were known to have used FEMA 154 (the Feedback Form was also posted on ATC’s web site); (2) a review of available information on the seismic performance of buildings, including a detailed review of the HAZUS fragility curves and an effort to correlate the relationship between results from the use of both the FEMA 154 rapid visual screening procedure and the FEMA 178 detailed seismic evaluation procedures on the same buildings;

(3) a Users Workshop midway in the project to learn first hand the problems and successes of organizations that had used the rapid visual screening procedure on buildings under their jurisdiction; (4) updating of the original FEMA 154 *Handbook* to create the second edition; and (5) updating of the original FEMA 155 *Supporting Documentation* report to create the second edition.

This second edition of the FEMA 154 *Handbook* provides a standard rapid visual screening procedure to identify, inventory, and rank buildings that are potentially seismically hazardous. The scoring system has been revised, based on new information, and the *Handbook* has been shortened and focused to facilitate implementation. The technical basis for the rapid visual screening procedure, including a summary of results from the efforts to solicit user feedback, is documented in the companion second edition of the FEMA 155 report, *Rapid Visual Screening of Buildings for Potential Seismic Hazards: Supporting Documentation*.

ATC gratefully acknowledges the personnel involved in developing the second editions of the FEMA 154 and FEMA 155 reports. Charles Scawthorn served as Co-Principal Investigator and Project Director. He was assisted by Kent David, Vincent Prabis, Richard A. Ranous, and Nilesh Shome, who served as Technical Consultants. Members of the Project Advisory Panel, who provided overall review and guidance for the project, were: Thalia Anagnos, John Baals, James R. Cagley (ATC Board Representative), Melvyn Green, Terry Hughes, Anne S. Kiremidjian, Joan MacQuarrie, Chris D. Poland, Lawrence D. Reaveley, Doug Smits, and Ted Winstead. William T. Holmes served as facilitator for the Users Workshop, and Keith Porter served as recorder. Stephanie A. King verified the Basic Structural Hazard Scores and the Score Modifiers. A. Gerald Brady, Peter N. Mork, and Michelle Schwartzbach provided report editing and production services. The affiliations of these individuals are provided in the list of project participants.

ATC also gratefully acknowledges the valuable assistance, support, and cooperation provided by Ugo Morelli, FEMA Project Officer. In addition, ATC acknowledges participants in the

FEMA 154 Users Workshop, which included, in addition to the project personnel listed above, the following individuals: Al Berstein, U. S. Bureau of Reclamation; Amitabha Datta, General Services Administration; Ben Emam, Amazon.com; Richard K. Eisner, California Office of Emergency Services; Ali Fattah, City of San Diego; Brian Kehoe, Wiss Janney Elstner Associates, Inc.; David Leung, City and County of San Francisco; Douglas McCall, Marx/Okubo; Richard Silva, National Park Service; Howard Simpson, Simpson

Gumpertz & Heger Inc.; Steven Sweeney, U. S. Army Civil Engineering Research Laboratory; Christine Theodoropoulos, University of Oregon; and Zan Turner, City and County of San Francisco. Those persons who responded to ATC's request to complete the voluntary FEMA 154 Users Feedback form are also gratefully acknowledged.

Christopher Rojahn, Principal Investigator
ATC Executive Director

Summary and Application

This FEMA 154 Report, *Rapid Visual Screening of Buildings for Potential Seismic Hazards: A Handbook*, is the first of a two-volume publication on a recommended methodology for rapid visual screening of buildings for potential seismic hazards. The technical basis for the methodology, including the scoring system and its development, are contained in the companion FEMA 155 report, *Rapid Visual Screening of Buildings for Potential Seismic Hazards: Supporting Documentation*. Both this document and the companion document are second editions of similar documents published by FEMA in 1988.

The rapid visual screening procedure (RVS) has been developed for a broad audience, including building officials and inspectors, and government agency and private-sector building owners (hereinafter, the "RVS authority"), to identify, inventory, and rank buildings that are potentially seismically hazardous. Although RVS is applicable to all buildings, its principal purpose is to identify (1) older buildings designed and constructed before the adoption of adequate seismic design and detailing requirements, (2) buildings on soft or poor soils, or (3) buildings having performance characteristics that negatively influence their seismic response. Once identified as potentially hazardous, such buildings should be further evaluated by a design professional experienced in seismic design to determine if, in fact, they are seismically hazardous.

The RVS uses a methodology based on a "sidewalk survey" of a building and a Data Collection Form, which the person conducting the survey (hereafter referred to as the screener) completes, based on visual observation of the building from the exterior, and if possible, the interior. The Data Collection Form includes space for documenting building identification information, including its use and size, a photograph of the building, sketches, and documentation of pertinent data related to seismic performance, including the development of a numeric seismic hazard score.

Once the decision to conduct rapid visual screening for a community or group of buildings has been made by the RVS authority, the screening effort can be expedited by pre-planning, including the training of screeners, and careful overall management of the process.

Completion of the Data Collection Form in the field begins with identifying the primary structural lateral-load-resisting system and structural materials of the building. Basic Structural Hazard Scores for various building types are provided on the form, and the screener circles the appropriate one. For many buildings, viewed only from the exterior, this important decision requires the screener to be trained and experienced in building construction. The screener modifies the Basic Structural Hazard Score by identifying and circling Score Modifiers, which are related to observed performance attributes, and which are then added (or subtracted) to the Basic Structural Hazard Score to arrive at a final Structural Score, S . The Basic Structural Hazard Score, Score Modifiers, and final Structural Score, S , all relate to the probability of building collapse, should severe ground shaking occur (that is, a ground shaking level equivalent to that currently used in the seismic design of new buildings). Final S scores typically range from 0 to 7, with higher S scores corresponding to better expected seismic performance.

Use of the RVS on a community-wide basis enables the RVS authority to divide screened buildings into two categories: those that are expected to have acceptable seismic performance, and those that may be seismically hazardous and should be studied further. An S score of 2 is suggested as a "cut-off", based on present seismic design criteria. Using this cut-off level, buildings having an S score of 2 or less should be investigated by a design professional experienced in seismic design.

The procedure presented in this *Handbook* is meant to be the preliminary screening phase of a multi-phase procedure for identifying potentially hazardous buildings. Buildings identified by this procedure must be analyzed in more detail by an experienced seismic design professional. Because rapid visual screening is designed to be performed from the street, with interior inspection not always possible, hazardous details will not always be visible, and seismically hazardous buildings may not be identified as such. Conversely, buildings initially identified as potentially hazardous by RVS may prove to be adequate.

Contents

FEMA Foreword.....	iii
Preface	v
Summary and Application	vii
List of Figures.....	xiii
List of Tables	xix
Illustration Credits	xxi
1. Introduction	1
1.1 Background.....	1
1.2 Screening Procedure Purpose, Overview, and Scope.....	2
1.3 Companion FEMA 155 Report.....	3
1.4 Relationship of FEMA 154 to Other Documents in the FEMA Existing Building Series	4
1.5 Uses of RVS Survey Results	4
1.6 How to Use this Handbook.....	4
2. Planning and Managing Rapid Visual Screening.....	5
2.1 Screening Implementation Sequence.....	5
2.2 Budget Development and Cost Estimation.....	6
2.3 Pre-Field Planning.....	6
2.4 Selection and Review of the Data Collection Form	7
2.4.1 Determination of Seismicity Region	8
2.4.2 Determination of Key Seismic Code Adoption Dates and Other Considerations	8
2.4.3 Determination of Cut-Off Score	10
2.5 Qualifications and Training for Screeners.....	11
2.6 Acquisition and Review of Pre-Field Data.....	11
2.6.1 Assessor’s Files	11
2.6.2 Building Department Files.....	12
2.6.3 Sanborn Maps.....	12
2.6.4 Municipal Databases.....	15
2.6.5 Previous Studies	15
2.6.6 Soils Information.....	15
2.7 Review of Construction Documents.....	17
2.8 Field Screening of Buildings	18
2.9 Checking the Quality and Filing the Field Data in the Record-Keeping System	18
3. Completing the Data Collection Form	19
3.1 Introduction	19
3.2 Verifying and Updating the Building Identification Information.....	20
3.2.1 Number of Stories.....	20
3.2.2 Year Built	20
3.2.3 Screener Identification.....	20
3.2.4 Total Floor Area	21
3.3 Sketching the Plan and Elevation Views	21
3.4 Determining Soil Type	21
3.5 Determining and Documenting Occupancy.....	22
3.5.1 Occupancy	22
3.5.2 Occupancy Load.....	23

3.6	Identifying Potential Nonstructural Falling Hazards	23
3.7	Identifying the Lateral-Load-Resisting System and Documenting the Related Basic Structural Score	24
3.7.1	Fifteen Building Types Considered by the RVS Procedure and Related Basic Structural Scores	24
3.7.2	Identifying the Lateral-Force-Resisting System	25
3.7.3	Interior Inspections	36
3.7.4	Screening Buildings with More Than One Lateral-Force Resisting System	37
3.8	Identifying Seismic Performance Attributes and Recording Score Modifiers	38
3.8.1	Mid-Rise Buildings	38
3.8.2	High-Rise Buildings	38
3.8.3	Vertical Irregularity	38
3.8.4	Plan Irregularity	40
3.8.5	Pre-Code	40
3.8.6	Post-Benchmark	41
3.8.7	Soil Type C, D, or E	41
3.9	Determining the Final Score	41
3.10	Photographing the Building	42
3.11	Comments Section	42
4.	Using the RVS Procedure Results	43
4.1	Interpretation of RVS Score	43
4.2	Selection of RVS “Cut-Off” Score	43
4.3	Prior Uses of the RVS Procedure	44
4.4	Other Possible Uses of the RVS Procedure	45
4.4.1	Using RVS Scores as a Basis for Hazardous Building Mitigation Programs	45
4.4.2	Using RVS Data in Community Building Inventory Development	46
4.4.3	Using RVS Data to Plan Postearthquake Building-Safety-Evaluation Efforts	46
4.4.4	Resources Needed for the Various Uses of the RVS Procedure	46
5.	Example Application of Rapid Visual Screening	49
5.1	Step 1: Budget and Cost Estimation	49
5.2	Step 2: Pre-Field Planning	50
5.3	Step 3: Selection and Review of the Data Collection Form	50
5.4	Step 4: Qualifications and Training for Screeners	51
5.5	Step 5: Acquisition and Review of Pre-Field Data	51
5.6	Step 6: Review of Construction Documents	55
5.7	Step 7: Field Screening of Buildings	55
5.8	Step 8: Transferring the RVS Field Data to the Electronic Building RVS Database	64
	Appendix A: Maps Showing Seismicity Regions	65
	Appendix B: Data Collection Forms and Quick Reference Guide	77
	Appendix C: Review of Design and Construction Drawings	83
	Appendix D: Exterior Screening for Seismic System and Age	85
D.1	Introduction	85
D.2	What to Look for and How to Find It	85
D.3	Identification of Building Age	85
D.4	Identification of Structural Type	88
D.5	Characteristics of Exposed Construction Materials	95
	Appendix E: Characteristics and Earthquake Performance of RVS Building Types	99
E.1	Introduction	99
E.2	Wood Frame (W1, W2)	99

E.2.1	Characteristics	99
E.2.2	Typical Earthquake Damage	100
E.2.3	Common Rehabilitation Techniques	102
E.3	Steel Frames (S1, S2)	103
E.3.1	Characteristics	103
E.3.2	Typical Earthquake Damage	105
E.3.3	Common Rehabilitation Techniques	105
E.4	Light Metal (S3)	106
E.4.1	Characteristics	106
E.4.2	Typical Earthquake Damage	107
E.5	Steel Frame with Concrete Shear Wall (S4).....	107
E.5.1	Characteristics	107
E.5.2	Typical Earthquake Damage	108
E.6	Steel Frame with Unreinforced Masonry Infill (S5).....	108
E.6.1	Characteristics	108
E.6.2	Typical Earthquake Damage	109
E.6.3	Common Rehabilitation Techniques	110
E.7	Concrete Moment-Resisting Frame (C1).....	110
E.7.1	Characteristics	110
E.7.2	Typical Earthquake Damage	112
E.7.3	Common Rehabilitation Techniques	113
E.8	Concrete Shear Wall (C2).....	113
E.8.1	Characteristics	113
E.8.2	Typical Types of Earthquake Damage	114
E.8.3	Common Rehabilitation.....	114
E.9	Concrete Frame with Unreinforced Masonry Infill (C3).....	114
E.9.1	Characteristics	114
E.9.2	Typical Earthquake Damage	116
E.9.3	Common Rehabilitation Techniques	116
E.10	Tilt-up Structures (PC1)	116
E.10.1	Characteristics	116
E.10.2	Typical Earthquake Damage	117
E.10.3	Common Rehabilitation Techniques	118
E.11	Precast Concrete Frame (PC2).....	118
E.11.1	Characteristics	118
E.11.2	Typical Earthquake Damage	120
E.11.3	Common Rehabilitation Techniques	120
E.12	Reinforced Masonry (RM1 and RM2)	121
E.12.1	Characteristics	121
E.12.2	Typical Earthquake Damage	121
E.12.3	Common Rehabilitation Techniques	121
E.13	Unreinforced Masonry (URM).....	122
E.13.1	Characteristics	122
E.13.2	Typical Earthquake Damage	126
E.13.3	Common Rehabilitation Techniques	126
Appendix F: Earthquakes and How Buildings Resist Them.....		129
F.1	The Nature of Earthquakes	129
F.2	Seismicity of the United States.....	130
F.3	Earthquake Effects.....	131
F.4	How Buildings Resist Earthquakes	134
References.....		137
Project Participants		139

List of Figures

Figure 1-1	High, moderate, and low seismicity regions of the conterminous United States. A different RVS Data Collection Form has been developed for each of these regions.....	1
Figure 1-2	Data Collection Forms for the three designated seismicity regions (low, moderate, and high).....	3
Figure 2-1	Rapid visual screening implementation sequence.....	5
Figure 2-2	Example RVS Data Collection Form (high seismicity).....	7
Figure 2-3	Sections 1 and 2 of Quick Reference Guide (for use with Data Collection Form).....	10
Figure 2-4	Building identification portion of RVS Data Collection Form.....	11
Figure 2-5	Example Sanborn map showing building information for a city block.....	12
Figure 2-6	Key to Sanborn map symbols.....	13
Figure 2-7	Sanborn map and corresponding aerial photograph of a city block.....	14
Figure 2-8	Photographs of elevation views of buildings shown in Figure 2-7.....	15
Figure 2-9	Examples of in-house screen displays of municipal databases.....	16
Figure 2-10	Location on Data Collection Form where soil type information is recorded.....	17
Figure 3-1	Example RVS Data Collection Form (high seismicity).....	19
Figure 3-2	Portion of Data Collection Form for documenting building identification.....	20
Figure 3-3	Sample Data Collection Form showing location for sketches of building plan and elevation views.....	21
Figure 3-4	Location on Data Collection Form where soil type information is documented (circled).....	21
Figure 3-5	Occupancy portion of Data Collection Form.....	22
Figure 3-6	Portion of Data Collection Form for documenting nonstructural falling hazards.....	23
Figure 3-7	Portion of Data Collection Form containing Basic Structural Hazard Scores.....	25
Figure 3-8	Typical frame structure. Features include: large window spans, window openings on many sides, and clearly visible column-beam grid pattern.....	35
Figure 3-9	Typical bearing wall structure. Features include small window span, at least two mostly solid walls, and thick load-bearing walls.....	35
Figure 3-10	Frame and bearing wall structures.....	36
Figure 3-11	Interior view showing fireproofed columns and beams, which indicate a steel building (S1, S2, or S4).....	37

Figure 3-12	Interior view showing concrete columns and girders, which indicate a concrete moment frame (C1).	37
Figure 3-13	Portion of Data Collection Form containing attributes that modify performance and associated score modifiers.	38
Figure 3-14	Elevation views showing vertical irregularities, with arrows indicating locations of particular concern.	39
Figure 3-15	Example of setbacks and a soft first story	39
Figure 3-16	Example of soft story conditions, where parking requirements result in large weak openings.	40
Figure 3-17	Plan views of various building configurations showing plan irregularities; arrows indicate possible areas of damage.	40
Figure 3-18	Example of a building, with a plan irregularity, with two wings meeting at right angles.	41
Figure 3-19	Example of a building, triangular in plan, subject to torsion.	41
Figure 3-20	Location on Data Collection Form where the final score, comments, and an indication if the building needs detailed evaluation are documented.	42
Figure 5-1	Screen capture of USGS web page showing SA values for 0.2 sec and 1.0 sec for ground motions having 2% probability of being exceeded in 50 years.	50
Figure 5-2	High seismicity Data Collection Form selected for Anyplace, USA	52
Figure 5-3	Quick Reference Guide for Anyplace USA showing entries for years in which seismic codes were first adopted and enforced and benchmark years.	53
Figure 5-4	Property information at example site in city’s geographic information system.	54
Figure 5-5	Exterior view of 3703 Roxbury Street	56
Figure 5-6	Close-up view of 3703 Roxbury Street exterior showing perimeter braced steel framing.	56
Figure 5-7	Building identification portion of Data Collection Form for Example 1, 3703 Roxbury Street.	56
Figure 5-8	Completed Data Collection Form for Example 1, 3703 Roxbury Street.	57
Figure 5-9	Exterior view of 3711 Roxbury.	58
Figure 5-10	Close-up view of 3711 Roxbury Street building exterior showing infill frame construction.	58
Figure 5-11	Completed Data Collection Form for Example 2, 3711 Roxbury Street.	59
Figure 5-12	Exterior view of 5020 Ebony Drive	60
Figure 5-13	Completed Data Collection Form for Example 3, 5020 Ebony Drive	61
Figure 5-14	Exterior view of 1450 Addison Avenue.	62

Figure 5-15	Building identification portion of Data Collection Form for Example 4, 1450 Addison Avenue.....	62
Figure 5-16	Completed Data Collection Form for Example 4, 1450 Addison Avenue	62
Figure A-1	Seismicity Regions of the Conterminous United States	66
Figure A-2	Seismicity Regions in California, Idaho, Nevada, Oregon, and Washington.....	67
Figure A-3	Seismicity Regions in Arizona, Montana, Utah, and Wyoming.....	68
Figure A-4	Seismicity Regions in Colorado, Kansas, New Mexico, Oklahoma, and Texas.....	69
Figure A-5	Seismicity Regions in Iowa, Michigan, Minnesota, Nebraska, North Dakota, South Dakota and Wisconsin.....	70
Figure A-6	Seismicity Regions in Illinois, Indiana, Kentucky, Missouri, and Ohio.....	71
Figure A-7	Seismicity Regions in Alabama, Arkansas, Louisiana, Mississippi, and Tennessee	72
Figure A-8	Seismicity Regions in Connecticut, Maine, Massachusetts, New Hampshire, Rhode Island, and Vermont.....	73
Figure A-9	Seismicity Regions in Delaware, Maryland, New Jersey, Pennsylvania, Virginia, and West Virginia.....	74
Figure A-10	Seismicity Regions in Florida, Georgia, North Carolina, and South Carolina	75
Figure A-11	Seismicity Regions in Alaska and Hawaii	76
Figure D-1	Photos showing basic construction, in steel-frame buildings and reinforced concrete-frame buildings.	91
Figure D-2	Building with exterior columns covered with a façade material.....	94
Figure D-3	Detail of the column façade of Figure D-2.	94
Figure D-4	Building with both shear walls (in the short direction) and frames (in the long direction)	94
Figure D-5	Regular, full-height joints in a building’s wall indicate a concrete tilt-up.	95
Figure D-6	Reinforced masonry wall showing no course of header bricks (a row of visible brick ends). 95	
Figure D-7	Reinforced masonry building with exterior wall of concrete masonry units, or concrete blocks.....	95
Figure D-8	A 1970s renovated façade hides a URM bearing-wall structure.....	95
Figure D-9	A concrete shear-wall structure with a 1960s renovated façade.....	96
Figure D-10	URM wall showing header courses (identified by arrows) and two washer plates indicating wall anchors.	96
Figure D-11	Drawing of two types of masonry pattern showing header bricks.....	96

Figure D-12	Diagram of common reinforced masonry construction. Bricks are left out of the bottom course at intervals to create cleanout holes, then inserted before grouting	97
Figure D-13	Brick veneer panels.	97
Figure D-14	Hollow clay tile wall with punctured tiles.....	97
Figure D-15	Sheet metal siding with masonry pattern.....	97
Figure D-16	Asphalt siding with brick pattern.	98
Figure D-17	Pre-1940 cast-in-place concrete with formwork pattern.	98
Figure E-1	Single family residence (an example of the W1 identifier, light wood-frame residential and commercial buildings less than 5000 square feet).	99
Figure E-2	Larger wood-framed structure, typically with room-width spans (W2, light, wood-frame buildings greater than 5000 square feet).	99
Figure E-3	Drawing of wood stud frame construction.	100
Figure E-4	Stud wall, wood-framed house.	101
Figure E-5	Drawing of timber pole framed house.....	101
Figure E-6	Timber pole framed house.....	101
Figure E-7	House off its foundation, 1983 Coalinga earthquake.	101
Figure E-8	Failed cripple stud wall, 1992 Big Bear earthquake.....	102
Figure E-9	Failure of post and pier foundation, Humbolt County.	102
Figure E-10	Seismic strengthening of a cripple wall, with plywood sheathing.	103
Figure E-11	Drawing of steel moment-resisting frame building.....	103
Figure E-12	Braced frame configurations.	104
Figure E-13	Braced steel frame, with chevron and diagonal braces. The braces and steel frames are usually covered by finish material after the steel is erected.	104
Figure E-14	Chevron bracing in steel building under construction.....	104
Figure E-15	Rehabilitation of a concrete parking structure using exterior X-braced steel frames.....	105
Figure E-16	Use of a braced frame to rehabilitate an unreinforced masonry building.....	106
Figure E-17	Drawing of light metal construction.....	106
Figure E-18	Connection of metal siding to light metal frame with rows of screws (encircled).....	107
Figure E-19	Prefabricated metal building (S3, light metal building).	107
Figure E-20	Drawing of steel frame with interior concrete shear-walls.....	108

Figure E-21	Concrete shear wall on building exterior.....	108
Figure E-22	Close-up of exterior shear wall damage during a major earthquake.....	108
Figure E-23	Drawing of steel frame with URM infill.....	109
Figure E-24	Example of steel frame with URM infill walls (S5).....	110
Figure E-25	Drawing of concrete moment-resisting frame building.....	111
Figure E-26	Extreme example of ductility in concrete, 1994 Northridge earthquake.....	111
Figure E-27	Example of ductile reinforced concrete column, 1994 Northridge earthquake; horizontal ties would need to be closer for greater demands.....	112
Figure E-28	Concrete moment-resisting frame building (C1) with exposed concrete, deep beams, wide columns (and with architectural window framing).....	112
Figure E-29	Locations of failures at beam-to-column joints in nonductile frames, 1994 Northridge earthquake.....	113
Figure E-30	Drawing of concrete shear-wall building.....	114
Figure E-31	Tall concrete shear-wall building: walls connected by damaged spandrel beams.....	115
Figure E-32	Shear-wall damage, 1989 Loma Prieta earthquake.....	115
Figure E-33	Concrete frame with URM infill.....	115
Figure E-34	Blow-up (lower photo) of distant view of C3 building (upper photo) showing concrete frame with URM infill (left wall), and face brick (right wall).....	115
Figure E-35	Drawing of tilt-up construction typical of the western United States. Tilt-up construction in the eastern United States may incorporate a steel frame.....	116
Figure E-36	Tilt-up industrial building, 1970s.....	117
Figure E-37	Tilt-up industrial building, mid- to late 1980s.....	117
Figure E-38	Tilt-up construction anchorage failure.....	117
Figure E-39	Result of failure of the roof beam anchorage to the wall in tilt-up building.....	117
Figure E-40	Newly installed anchorage of roof beam to wall in tilt-up building.....	118
Figure E-41	Drawing of precast concrete frame building.....	119
Figure E-42	Typical precast column cover on a steel or concrete moment frame.....	120
Figure E-43	Exposed precast double-T sections and overlapping beams are indicative of precast frames.....	120
Figure E-44	Example of precast double-T section during installation.....	120

Figure E-45	Precast structural cross; installation joints are at sections where bending is minimum during high seismic demand.....	120
Figure E-46	Modern reinforced brick masonry.....	121
Figure E-47	Drawing of unreinforced masonry bearing-wall building, 2-story.....	122
Figure E-48	Drawing of unreinforced masonry bearing-wall building, 4-story.....	123
Figure E-49	Drawing of unreinforced masonry bearing-wall building, 6-story.....	124
Figure E-50	East coast URM bearing-wall building.....	124
Figure E-51	West coast URM bearing-wall building.....	124
Figure E-52	Drawings of typical window head features in URM bearing-wall buildings.....	125
Figure E-53	Parapet failure leaving an uneven roof line, due to inadequate anchorage, 1989 Loma Prieta earthquake.....	126
Figure E-54	Damaged URM building, 1992 Big Bear earthquake.....	126
Figure E-55	Upper: Two existing anchors above three new wall anchors at floor line using decorative washer plates. Lower: Rehabilitation techniques include closely spaced anchors at floor and roof levels.....	127
Figure F-1	The separate tectonic plates comprising the earth's crust superimposed on a map of the world.....	129
Figure F-2	Seismicity of the conterminous United States 1977-1997. This reproduction shows earthquake locations without regard to magnitude or depth. The San Andreas fault and other plate boundaries are indicated with white lines.....	131
Figure F-3	Seismicity of Alaska 1977 – 1997. The white line close to most of the earthquakes is the plate boundary, on the ocean floor, between the Pacific and North America plates.....	132
Figure F-4	Seismicity of Hawaii 1977 – 1997.....	132.
Figure F-5	Mid-rise building collapse, 1985 Mexico City earthquake.....	133
Figure F-6	Near-field effects, 1992 Landers earthquake, showing house (white arrow) close to surface faulting (black arrow); the insert shows a house interior.....	134
Figure F-7	Collapsed chimney with damaged roof, 1987 Whittier Narrows earthquake.....	134
Figure F-8	House that slid off foundation, 1994 Northridge earthquake.....	135
Figure F-9	Collapsed cripple stud walls dropped this house to the ground, 1992 Landers and Big Bear earthquakes.....	135
Figure F-10	This house has settled to the ground due to collapse of its post and pier foundation.....	135
Figure F-11	Collapse of unreinforced masonry bearing wall, 1933 Long Beach earthquake.....	135
Figure F-12	Collapse of a tilt-up bearing wall, 1994 Northridge earthquake.....	135

List of Tables

Table 2-1	Regions of Seismicity with Corresponding Spectral Acceleration Response (from FEMA 310).....	8
Table 2-2	Benchmark Years for RVS Procedure Building Types (from FEMA 310).....	9
Table 2-3	Checklist of Issues to be Considered During Pre-Field Work Review of the Data Collection Form	10
Table 2-4	Checklist of Field Equipment Needed for Rapid Visual Screening.....	18
Table 3-1	Build Type Descriptions, Basic Structural Hazard Scores, and Performance in Past Earthquakes.....	26
Table 4-1	Matrix of Personnel and Material Resources Needed for Various FEMA 154 RVS Applications.....	47
Table D-1	Photographs, Architectural Characteristics, and Age of Residential Buildings.....	86
Table D-2	Illustrations, Architectural Characteristics, and Age of Commercial Structures	87
Table D-3	Photographs, Architectural Characteristics, and Age of Miscellaneous Structures	90
Table D-4	Most Likely Structural Types for Pre-1930 Buildings	92
Table D-5	Most Likely Structural Types for 1930-1945 Buildings.....	92
Table D-6	Most Likely Structural Types for 1945-1960 Buildings.....	93
Table D-7	Most Likely Structural Types for Post-1960 Buildings.....	93

Illustration Credits

Figures

1-1, A-1 to 11
5-5, 6, 12, 14, F-11
2-1,8;
3-10 to 12, 15, 16, 18, 19;
Table 3-1, Building Type
W1, W2, S1 to S5, C1 to
C3, PC1 (top), PC2,
RM1, RM2, URM;
5-9, 10,
D-1 to 5;
E-1, 2, 4, 6 to 10, 13 to 16,
17 to 19, 21, 22, 24, 26 to
29, 32 to 34, 36 to 40, 42,
44, 46, 50, 51, 53 to 55;
F-5 to 10, 12;
Table D-1c to e; Table D-2
b to o; Table D-3a to e, h
2-5, 6, 7
2-9
3-8, 9; E-43, 45
5-1, F-1 to 4
5-3
D-6, 8, 9, 10
D-13 to 17; Table D-1a, b;
Table D-3f, g
D-7
D-11, 12

E-3, 23, 25,30;
E-35, 41, 47, 48, 49

E-5, 12
E-11, 20

E-31
E-52

Table D-2a

Table 3-1, Building Type
PC1 (lower)
E-39

Credit

Maps credited to Nilesh Shome / ABS Consulting / EQE Engineers / USGS
Richard Ranous / ABS Consulting / EQE Engineers
Charles Scawthorn / ABS Consulting / EQE Engineers

Sanborn Maps
Oakland, California and Mecklenberg County, North Carolina, web pages
Drawings by Kit Wong
USGS web site
Los Angeles/San Pedro, California; city GIS
Photographs by Kit Wong

Robert Bruce
Allen, E., 1985, *Fundamentals of Building Construction and Methods*, John Wiley and sons, New York.
Lagorio, H., Friedman, H., and K. Wong (1986). *Issues for Seismic Strengthening of Existing Buildings: A Practical Guide for Architects*. Center for Environmental Design, University of California at Berkeley.
Drawing from *National Multihazard Survey Instructions*. FEMA, TR-84.
Steinbrugge, K. (1982). *Earthquakes, Volcanoes, and Tsunamis, An Anatomy of Hazards*. Skandia American Group, New York.
James Stratta
Ramsay/Sleeper *Architectural Graphic Standards*, Seventh Edition (1981). R.T. Packard, AIA, ed., John Wiley & Sons, New York.
A Field Guide to American Architecture (1980), The New American Library, Inc., New York.
Earthquake Engineering Research Institute.

Anonymous, but greatly appreciated

Chapter 1

Introduction

1.1 Background

Rapid visual screening of buildings for potential seismic hazards, as described herein, originated in 1988 with the publication of the FEMA 154 Report, *Rapid Visual Screening of Buildings for Potential Seismic Hazards: A Handbook*. Written for a broad audience ranging from engineers and building officials to appropriately trained nonprofessionals, the *Handbook* provided a “sidewalk survey” approach that enabled users to classify surveyed buildings into two categories: those acceptable as to risk to life safety or those that may be seismically hazardous and should be evaluated in more detail by a design professional experienced in seismic design.

During the decade following publication of the first edition of the FEMA 154 *Handbook*, the rapid visual screening (RVS) procedure was used by private-sector organizations and government agencies to evaluate more than 70,000 buildings nationwide (ATC, 2002). This widespread application provided important information about the purposes for which the document was used, the ease-of-use of the document, and perspectives on the accuracy of the scoring system upon which the procedure was based.

Concurrent with the widespread use of the document, damaging earthquakes occurred in California and elsewhere, and extensive research and development efforts were carried out under the National Earthquake Hazards Reduction Program (NEHRP). These efforts yielded important new data on the performance of buildings in earthquakes, and on the expected distribution, severity, and occurrence of earthquake-induced ground shaking.

The data and information gathered during the first decade after publication (experience in applying the original *Handbook*, new building earthquake performance data, and new ground shaking information)

have been used to update and improve the rapid visual screening procedure provided in this second edition of the FEMA 154 Report, *Rapid Visual Screening of Buildings for Potential Seismic Hazards: A Handbook*. The revised RVS procedure retains the same framework and approach of the original procedure, but incorporates a revised scoring system compatible with the ground motion criteria in the FEMA 310 Report, *Handbook for Seismic Evaluation of Buildings—A Prestandard* (ASCE, 1998), and the damage estimation data provided in the recently developed FEMA-funded HAZUS damage and loss estimation methodology (NIBS, 1999). As in the original *Handbook*, a Data Collection Form is provided for each of three seismicity regions: low, moderate, and high. However, the boundaries of the low, moderate, and high seismicity regions in the original *Handbook* have been modified (Figure 1-1), reflecting new knowledge on the expected distribution, severity, and occurrence of earthquake ground shaking, and a change in the

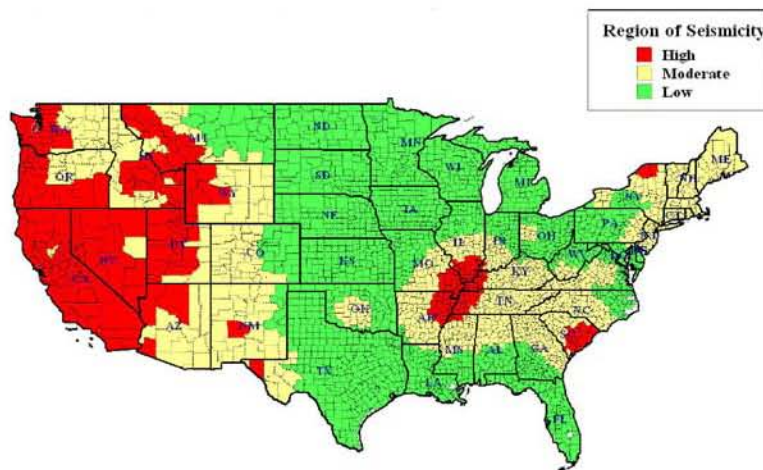

Note: Seismicity regions are based on ground motions having a 2% probability of exceedance in 50 years.

Figure 1-1 High, moderate, and low seismicity regions of the conterminous United States. A different RVS Data Collection Form has been developed for each of these regions. Enlarged maps are available in Appendix A.

recurrence interval considered, from a 475-year average return period (corresponding to ground motions having a 10% probability of exceedance in 50 years) to a 2475-year average return period (corresponding to ground motions having a 2% probability of exceedance in 50 years).

This second edition of the FEMA 154 *Handbook* has been shortened and focused to facilitate implementation. Other improvements include:

- guidance on planning and managing an RVS survey, including the training of screeners and the acquisition of data from assessor files and other sources to obtain more reliable information on age, structural system, and occupancy;
- more guidance for identifying the structural (lateral-load-resisting) system in the field;
- the use of interior inspection or pre-survey reviews of building plans to identify (or verify) a building's lateral-load-resisting system;
- updated Basic Structural Hazard Scores and Score Modifiers that are derived from analytical calculations and recently developed HAZUS fragility curves for the model building types considered by the RVS methodology;
- the use of new seismic hazard information that is compatible with seismic hazard criteria specified in other related FEMA documents (see Section 1.4 below); and
- a revised Data Collection Form that provides space for documenting soil type, additional options for documenting falling hazards, and an expanded list of occupancy types.

1.2 Screening Procedure Purpose, Overview, and Scope

The RVS procedure presented in this *Handbook* has been formulated to identify, inventory, and rank buildings that are potentially seismically hazardous. Developed for a broad audience that includes building officials and inspectors, government agencies, design professionals, private-sector building owners (particularly those that own or operate clusters or groups of buildings), faculty members who use the RVS procedure as a training tool, and informed appropriately trained, members of the public, the RVS procedure can be implemented relatively quickly and inexpensively to develop a list of

potentially hazardous buildings without the high cost of a detailed seismic analysis of individual buildings. If a building receives a high score (i.e., above a specified cut-off score, as discussed later in this *Handbook*), the building is considered to have adequate seismic resistance. If a building receives a low score on the basis of this RVS procedure, it should be evaluated by a professional engineer having experience or training in seismic design. On the basis of this detailed inspection, engineering analyses, and other detailed procedures, a final determination of the seismic adequacy and need for rehabilitation can be made.

During the planning stage, which is discussed in Chapter 2, the organization that is conducting the RVS procedure (hereinafter, the “RVS authority”) will need to specify how the results from the survey will be used. If the RVS authority determines that a low score automatically requires that further study be performed by a professional engineer, then some acceptable level of qualification held by the inspectors performing the screening will be necessary. RVS projects have a wide range of goals and they have constraints on budget, completion date and accuracy, which must be considered by the RVS authority as it selects qualification requirements of the screening personnel. Under most circumstances, a well-planned and thorough RVS project will require engineers to perform the inspections. In any case, the program should be overseen by a design professional knowledgeable in seismic design for quality assurance purposes.

The RVS procedure in this *Handbook* is designed to be implemented without performing structural analysis calculations. The RVS procedure utilizes a scoring system that requires the user to (1) identify the primary structural lateral-load-resisting system; and (2) identify building attributes that modify the seismic performance expected of this lateral-load-resisting system. The inspection, data collection, and decision-making process typically will occur at the building site, taking an average of 15 to 30 minutes per building (30 minutes to one hour if access to the interior is available). Results are recorded on one of three Data Collection Forms (Figure 1-2), depending on the seismicity of the region being surveyed. The Data Collection Form, described in greater detail in Chapter 3, includes space for documenting building identification information, including its use and size, a photograph of the building, sketches, and documentation of pertinent data related to seismic performance, including the development of a

numeric seismic hazard score. The scores are based on average expected ground shaking levels for the seismicity region as well as the seismic design and construction practices for that region¹. Buildings may be reviewed from the sidewalk without the benefit of building entry, structural drawings, or structural calculations. Reliability and confidence in building attribute determination are increased, however, if the structural framing system can be verified during interior inspection, or on the basis of a review of construction documents.

The RVS procedure is intended to be applicable nationwide, for all conventional building types. Bridges, large towers, and other non-building structure types, however, are not covered by the procedure. Due to budget or other constraints, some RVS authorities may wish to restrict their RVS to identifying building types that they consider the most hazardous, such as unreinforced masonry or nonductile concrete buildings. However, it is recommended, at least initially, that all conventional building types be considered, and that elimination of certain building types from the screening be well documented and supported with office calculations and field survey data that justify their elimination. It is possible that, in some cases, even buildings designed to modern codes, such as those with configurations that induce extreme torsional response and those with abrupt changes in stiffness, may be potentially hazardous.

¹ Seismic design and construction practices vary by seismicity region, with little or no seismic design requirements in low seismicity regions, moderate seismic design requirements in moderate seismicity regions, and extensive seismic design requirements in high seismicity regions. The requirements also vary with time, and are routinely updated to reflect new knowledge about building seismic performance.

The figure shows three overlapping FEMA-154 Data Collection Forms for Potential Seismic Hazards, categorized by seismicity level: LOW, MODERATE, and HIGH. Each form consists of a grid for field notes, a table for building attributes, and a detailed scoring table. The scoring table includes columns for Building Type, Occupancy, Soil, Type, and Falling Hazards, leading to a Final Score (S) and a Detailed Evaluation Required (YES/NO) section.

BUILDING TYPE	OCCUPANCY					SOIL					TYPE					FALLING HAZARDS			
	Assembly Emer. Services	Govt. Commercial	Office Residential	School	Other	SI (SI)	S2 (S2)	S3 (S3)	S4 (S4)	S5 (S5)	C1 (C1)	C2 (C2)	C3 (C3)	PC1 (PC1)	PC2 (PC2)	RM1 (RM1)	RM2 (RM2)	URM (URM)	
Basic Score	4.4	3.8	2.8	3.0	3.2	2.8	2.0	2.5	2.8	1.6	2.6	2.4	2.8	2.8	1.8				
Mid Rise (4 to 7 stories)	N/A	N/A	+0.2	-0.4	N/A	+0.4	-0.4	-0.4	-0.4	-0.2	N/A	+0.2	-0.4	-0.4	0.0				
High Rise (> 7 stories)	N/A	N/A	+0.5	+0.8	N/A	+0.8	-0.8	-0.6	-0.8	+0.3	N/A	+0.4	N/A	+0.6	N/A				
Vertical Irregularity	-2.6	-2.0	-1.0	-1.5	N/A	-1.0	-1.0	-1.5	-1.0	-1.0	N/A	-1.0	-1.0	-1.0	-1.0				
Plan Irregularity	-0.5	-0.5	-0.5	-0.5	-0.5	-0.5	-0.5	-0.5	-0.5	-0.5	-0.5	-0.5	-0.5	-0.5	-0.5				
Pre-Code	0.0	-1.0	-1.0	-0.8	-0.6	-0.8	-0.2	-1.2	-1.0	-0.2	-0.8	-0.8	-1.0	-0.8	-0.2				
Post-Benchmark	+2.4	+2.4	+1.4	+1.4	N/A	+1.6	N/A	+1.4	+2.4	N/A	+2.4	N/A	+2.8	+2.8	+2.6	N/A			
Soil Type C	0.0	0.4	0.4	0.4	0.4	0.4	0.4	0.4	0.4	0.4	0.4	0.4	0.4	0.4	0.4				
Soil Type D	0.0	-0.8	-0.6	-0.6	-0.6	-0.6	-0.4	-0.6	-0.6	-0.4	-0.6	-0.6	-0.6	-0.6	-0.6				
Soil Type E	0.0	-0.8	-1.2	-1.2	-1.0	-1.2	-0.8	-1.2	-0.8	-0.8	-0.4	-1.2	-0.4	-1.2	-0.4				

Figure 1-2 Data Collection Forms for the three designated seismicity regions (low, moderate, and high).

1.3 Companion FEMA 155 Report

A companion volume to this report, *Rapid Visual Screening of Buildings for Potential Seismic Hazards: Supporting Documentation (second edition)* (FEMA 155) documents the technical basis for the RVS procedure described in this *Handbook*, including the method for calculating the Basic Structural Scores and Score Modifiers. The FEMA 155 report (ATC, 2002) also summarizes other information considered during development of this *Handbook*, including the efforts to solicit user feedback and a FEMA 154 Users Workshop held in September 2000. The FEMA 155 document is available from FEMA by

dialing 1-800-480-2520 and should be consulted for any needed or desired supporting documentation.

1.4 Relationship of FEMA 154 to Other Documents in the FEMA Existing Building Series

The FEMA 154 *Handbook* has been developed as an integral and fundamental part of the FEMA report series on seismic safety of existing buildings. It is intended for use by design professionals and others to mitigate the damaging effects of earthquakes on existing buildings. The series includes:

- FEMA 154 (this handbook), which provides a procedure that can be rapidly implemented to identify buildings that are potentially seismically hazardous.
- FEMA 310, *Handbook for Seismic Evaluation of Buildings—A Prestandard* (ASCE, 1998), which provides a procedure to inspect in detail a given building to evaluate its seismic resisting capacity (an updated version of the FEMA 178 *NEHRP Handbook for the Seismic Evaluation of Existing Buildings* [BSSC, 1992]). The FEMA 310 Handbook is ideally suited for use on those buildings identified by the FEMA 154 RVS procedure as potentially hazardous.

FEMA 310 is expected to be superseded in 2002 by ASCE 31, a standard of the American Society of Civil Engineers approved by the American National Standards Institute (ANSI). References in this *Handbook* to FEMA 310 should then refer to ASCE 31.

- FEMA 356, *Prestandard and Commentary for the Seismic Rehabilitation of Buildings* (ASCE, 2000), which provides recommended procedures for the seismic rehabilitation of buildings with inadequate seismic capacity, as determined, for example, by a FEMA 310 (or FEMA 178) evaluation. The FEMA 356 Prestandard is based on the guidance provided in the FEMA 273 *NEHRP Guidelines for the Seismic Rehabilitation of Buildings* (ATC, 1997a), and companion FEMA 274 *Commentary on the NEHRP Guidelines for the Seismic Rehabilitation of Buildings* (ATC, 1997b).

1.5 Uses of RVS Survey Results

While the principal purpose of the RVS procedure is to identify potentially seismically hazardous buildings needing further evaluation, results from RVS surveys can also be used for other purposes. These include: (1) ranking a community's (or agency's) seismic rehabilitation needs; (2) designing seismic hazard mitigation programs for a community (or agency); (3) developing inventories of buildings for use in regional earthquake damage and loss impact assessments; (4) planning postearthquake building safety evaluation efforts; and (5) developing building-specific seismic vulnerability information for purposes such as insurance rating, decision making during building ownership transfers, and possible triggering of remodeling requirements during the permitting process. Additional discussion on the use of RVS survey results is provided in Chapter 4.

1.6 How to Use this Handbook

The *Handbook* has been designed to facilitate the planning and execution of rapid visual screening. It is assumed that the RVS authority has already decided to conduct the survey, and that detailed guidance is needed for all aspects of the surveying process. Therefore, the main body of the *Handbook* focuses on the three principal activities in the RVS: planning, execution, and data interpretation. Chapter 2 contains detailed information on planning and managing an RVS. Chapter 3 describes in detail how the Data Collection Form should be completed, and Chapter 4 provides guidance on interpreting and using the results from the RVS. Finally, Chapter 5 provides several example applications of the RVS procedure on real buildings.

Relevant seismic hazard maps, full-sized Data Collection Forms, including a Quick Reference Guide for RVS implementation, guidance for reviewing design and construction drawings, and additional guidance for identifying a building's seismic lateral-load-resisting system from the street are provided in Appendices A, B, C, and D, respectively. Appendix E provides additional information on the building types considered in the RVS procedure, and Appendix F provides an overview of earthquake fundamentals, the seismicity of the United States, and earthquake effects.

Chapter 2

Planning and Managing Rapid Visual Screening

Once the decision to conduct rapid visual screening (RVS) for a community or group of buildings has been made by the RVS authority, the screening effort can be expedited by pre-planning and careful overall management of the process. This chapter describes the overall screening implementation sequence and provides detailed information on important pre-planning and management aspects. Instructions on how to complete the Data Collection Form are provided in Chapter 3.

2.1 Screening Implementation Sequence

There are several steps involved in planning and performing an RVS of potentially seismically hazardous buildings. As a first step, if it is to be a public or community project, the local governing body and local building officials should formally approve of the general procedure. Second, the public or the members of the community should be informed about the purpose of the screening process and how it will be carried out. There are also other decisions to be made, such as use of the screening results, responsibilities of the building owners and the community, and actions to be taken. Some of these decisions are specific to each community and therefore are not discussed in this *Handbook*.

The general sequence of implementing the RVS procedure is depicted in Figure 2-1. The implementation sequence includes:

- Budget development and cost estimation, recognizing the expected extent of the screening and further use of the gathered data;
- Pre-field planning, including selection of the area to be surveyed, identification of building types to be

screened, selection and development of a record-keeping system, and compilation and development of maps that document local seismic hazard information;

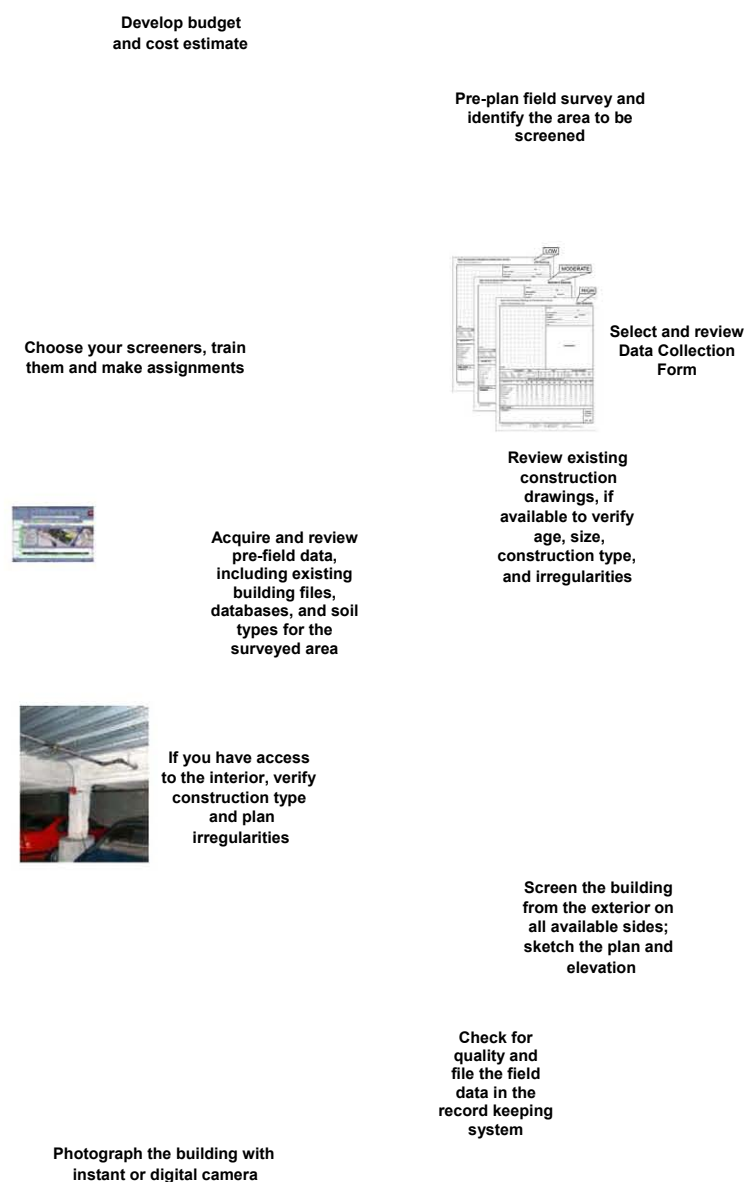

Figure 2-1 Rapid visual screening implementation sequence.

- Selection and review of the Data Collection Form;
- Selection and training of screening personnel;
- Acquisition and review of pre-field data; including review of existing building files and databases to document information identifying buildings to be screened (e.g., address, lot number, number of stories, design date) and identifying soil types for the survey area;
- Review of existing building plans, if available;
- Field screening of individual buildings (see Chapter 3 for details), which consists of:
 1. Verifying and updating building identification information,
 2. Walking around the building and sketching a plan and elevation view on the Data Collection Form,
 3. Determining occupancy (that is, the building use and number of occupants),
 4. Determining soil type, if not identified during the pre-planning process,
 5. Identifying potential nonstructural falling hazards,
 6. Identifying the seismic-lateral-load-resisting system (entering the building, if possible, to facilitate this process) and circling the Basic Structural Hazard Score on the Data Collection Form,
 7. Identifying and circling the appropriate seismic performance attribute Score Modifiers (e.g., number of stories, design date, and soil type) on the Data Collection Form,
 8. Determining the Final Score, *S* (by adjusting the Basic Structural Hazard Score with the Score Modifiers identified in Step 7), and deciding if a detailed evaluation is required, and
 9. Photographing the building; and
- Checking the quality and filing the screening data in the record-keeping system, or database.

2.2 Budget Development and Cost Estimation

Many of the decisions that are made about the level of detail documented during the rapid visual screening procedure will depend upon budget constraints. Although the RVS procedure is

designed so field screening of each building should take no more than 15 to 30 minutes (30 minutes to one hour if access to the interior is obtained), time and funds should also be allocated for pre-field data collection. Pre-field data collection can be time consuming (10 to 30 minutes per building depending on the type of supplemental data available). However, it can be extremely useful in reducing the total field time and can increase the reliability of data collected in the field. A good example of this is the age, or design date, of a building. This might be readily available from building department files but is much more difficult to estimate from the street. Another issue to consider is travel time, if the distance between buildings to be screened is large. Because pre-field data collection and travel time could be a significant factor in budget allocations, it should be considered in the planning phase.

Other factors that should be considered in cost estimation are training of personnel and the development and administration of a record-keeping system for the screening process. The type of record keeping system selected will be a function of existing procedures and available funds as well as the ultimate goal of the screening. For example, if the screening is to be used solely for potential seismic damage estimation purposes, administrative costs will be different from those of a screening in which owners of low-scoring buildings must subsequently be notified, and compliance with ordinances is required.

2.3 Pre-Field Planning

The RVS authority may decide due to budget, time or other types of constraints, that priorities should be set and certain areas within the region should be surveyed immediately, whereas other areas can be surveyed at a later time because they are assumed to be less hazardous. An area may be selected because it is older and may have a higher density of potentially seismically hazardous buildings relative to other areas. For example an older part of the RVS authority region that consists mainly of commercial unreinforced masonry buildings may be of higher priority than a newer area with mostly warehouse facilities, or a residential section of a city consisting of wood-frame single-family dwellings.

Compiling and developing maps for the surveyed region is important in the initial planning phase as well as in scheduling of screeners. Maps of soil profiles, although limited, will be directly useful in the screening, and maps of landslide potential, liquefaction potential, and active faults

provide useful background information about the relative hazard in different areas. Maps of lots will be useful in scheduling screeners and, as data are collected, in identifying areas with large numbers of potentially hazardous buildings.

Another important phase of pre-field planning is interaction with the local design profession and building officials. Discussions should include verification of when certain aspects of seismic design and detailing were adopted and enforced. This will be used in adjusting the scoring system for local practices and specifying benchmark years.

The record-keeping system will vary among RVS authorities, depending on needs, goals, budgets and other constraints, and may in fact consist of several systems. Part of this planning phase may include deciding how buildings are to be identified. Some suggestions are street address, assessor's parcel number, census tract, and lot number or owner. Consideration should be given to developing a computerized database containing location and other building information, which could easily be used to generate peel-off labels for the Data Collection Form, or to generate forms that incorporate unique information for each building.

The advantage of using a computerized record generation and collection system is that graphical data, such as sketches and photographs, are increasingly more easily converted to digital form and stored on the computer, especially if they are collected in digital format in the field. This can be facilitated through the use of personal digital assistants (PDAs), which would require the development of a FEMA 154 application, and the use of digital cameras.

If a computerized database is not used, microfilm is a good storage medium for original hard copy, because photographs, building plans, screening forms and subsequent follow-up documentation can be kept together and easily copied. Another method that has been used is to generate a separate hard-copy file for each building as it is screened. In fact, the screening form can be reproduced on a large envelope and all supporting material and photographs stored inside. This solves any problems associated with attaching multiple sketches and photographs, but the files grow rapidly and may become unmanageable.

2.4 Selection and Review of the Data Collection Form

There are three Data Collection Forms, one for each of the following three regions of seismicity: low (L), moderate (M), and high (H). Full-sized versions of each form are provided in Appendix B, along with a Quick Reference Guide that contains definitions and explanations for terms used on the Data Collection Form. Each Data Collection Form (see example, Figure 2-2) provides space to record the building identification information, draw a sketch of the building (plan and elevation views), attach a photograph of the building, indicate the occupancy, indicate the soil type, document the existence of falling hazards, develop a Final Structural Score, *S*, for the building, indicate if a detailed evaluation is required, and provide additional comments. The structural scoring system consists of a matrix of Basic Structural Hazard Scores (one for each building type and its associated seismic lateral-force-resisting system) and Score Modifiers to

Rapid Visual Screening of Buildings for Potential Seismic Hazards
FEMA-154 Data Collection Form

HIGH Seismicity

Address: _____ Zip _____

Other Identifiers _____

No. Stories _____ Year Built _____

Screener _____ Date _____

Total Floor Area (sq. ft.) _____

Building Name _____

Use _____

PHOTOGRAPH

Scale: _____

OCCUPANCY				SOIL					TYPE						FALLING HAZARDS						
Assembly	Govt	Office	Number of Persons	A	B	C	D	E	F	L			M								
Commercial	Historic	Residential	0-10	Hard	Avg	Dense	Stiff	Soft	Poor	Unreinforced			Parapets			Cladding			Other		
Emer. Services	Industrial	School	101-1000	Rock	Rock	Soil	Soil	Soil	Soil	Chimneys											
BASIC SCORE, MODIFIERS, AND FINAL SCORE, S																					
BUILDING TYPE	W1	W2	S1 (MRF)	S2 (BR)	S3 (LM)	S4 (RC BR)	S5 (RM MRF)	C1 (MRF)	C2 (BR)	C3 (RM MRF)	PC1 (TU)	PC2	RM1 (FD)	RM2 (RC)	URM						
Basic Score	4.4	3.8	2.8	3.0	3.2	2.8	2.0	2.5	2.8	1.8	2.6	2.4	2.8	2.8	1.8						
Mid Rise (4 to 7 stories)	N/A	N/A	+0.2	-0.4	N/A	-0.4	-0.4	+0.4	+0.4	+0.2	N/A	+0.2	-0.4	-0.4	0.0						
High Rise (> 7 stories)	N/A	N/A	+0.6	-0.8	N/A	-0.8	-0.8	+0.6	+0.6	+0.3	N/A	+0.4	N/A	-0.6	N/A						
Vertical Irregularity	-2.5	-2.0	-1.0	-1.5	N/A	-1.0	-1.0	-1.5	-1.0	-1.0	N/A	-1.0	-1.0	-1.0	-1.0						
Plan Irregularity	-0.5	-0.5	-0.5	-0.5	-0.5	-0.5	-0.5	-0.5	-0.5	-0.5	-0.5	-0.5	-0.5	-0.5	-0.5						
Fire-Code	0.0	-1.0	-1.0	-0.8	-0.6	-0.8	-0.2	-1.2	-1.0	-0.2	-0.8	-0.8	-1.0	-0.8	-0.2						
Post-Benchmark	+2.4	+2.4	+1.4	+1.4	N/A	+1.6	N/A	+1.4	+2.4	N/A	+2.4	N/A	+2.6	+2.6	N/A						
Soil Type C	0.0	-0.4	-0.4	-0.4	-0.4	-0.4	-0.4	-0.4	-0.4	-0.4	-0.4	-0.4	-0.4	-0.4	-0.4						
Soil Type D	0.0	-0.8	-0.8	-0.8	-0.8	-0.8	-0.8	-0.8	-0.8	-0.8	-0.8	-0.8	-0.8	-0.8	-0.8						
Soil Type E	0.0	-0.8	-1.2	-1.2	-1.0	-1.2	-0.8	-1.2	-0.8	-0.8	-0.4	-1.2	-0.4	-0.6	-0.8						
FINAL SCORE, S																					
COMMENTS															Detailed Evaluation Required						
															YES NO						

* = Estimated, subjective, or unreliable data
 BR = Braced frame
 FD = Flexible diaphragm
 LM = Light metal
 MRF = Moment-resisting frame
 RC = Reinforced concrete
 RD = Rigid diaphragm
 SW = Shear wall
 TU = Tilt up
 URM MRF = Unreinforced masonry infill

Figure 2-2 Example RVS Data Collection Form (high seismicity).

account for observed attributes that modify seismic performance. The Basic Structural Hazard Scores and Score Modifiers are based on (1) design and construction practices in the region, (2) attributes known to decrease or increase seismic resistance capacity, and (3) maximum considered ground motions for the seismicity region under consideration. The Basic Structural Hazard Score, Score Modifiers, and Final Structural Score, *S*, all relate to the probability of building collapse, should the maximum ground motions considered by the RVS procedure occur at the site. Final *S* scores typically range from 0 to 7, with higher *S* scores corresponding to better seismic performance.

The maximum ground motions considered in the scoring system of the RVS procedure are consistent with those specified for detailed building seismic evaluation in the FEMA 310 Report, *Handbook for the Seismic Evaluation of Buildings—A Prestandard*. Such ground motions generally have a 2% chance of being exceeded in 50 years, and are multiplied by a 2/3 factor in the FEMA 310 evaluation procedures and in the design requirements for new buildings in FEMA 302, *Recommended Provisions for Seismic Regulations for New Buildings and Other Structures* (BSSC, 1997). (Ground motions having a 2% probability of being exceeded in 50 years are commonly referred to as the maximum considered earthquake (MCE) ground motions.)

2.4.1 Determination of Seismicity Region

To select the appropriate Data Collection Form, it is first necessary to determine the seismicity region in which the area to be screened is located. The seismicity region (H, M, or L) for the screening area can be determined by one of two methods:

1. Find the location of the surveyed region on the seismicity map of Figure 1-1, or one of the enlarged seismicity maps provided in Appendix A, and identify the corresponding seismicity region, or;
2. Access the U.S. Geological Survey web page (<http://geohazards.cr.usgs.gov/eq/>), select “Hazard by Zip Code” or “Hazard by Lat/Long” under the “Seismic Hazard” heading, enter the appropriate values of zip code or latitude and longitude, select the spectral acceleration value (SA) for a period of 0.2 seconds and the SA value for a period of 1.0 second, multiply the SA values by 2/3, and use the criteria of Table 2-1 to select the appropriate seismicity region, assuming that the highest seismicity level

defined by the parameters in Table 2-1 shall govern.

Use more recent additions of these maps when they become available.

The web site approach of Method 2, which uses seismicity region definitions used in other recently developed FEMA documents, is preferred as it enables the user to determine seismicity based on a more precisely specified location. In contrast, each county shown in Figure 1-1 is assigned its seismicity on the basis of the highest seismicity in that county, even though it may only apply to a small portion of the county.

Table 2-1 Regions of Seismicity with Corresponding Spectral Acceleration Response (from FEMA 310)

<i>Region of Seismicity</i>	<i>Spectral Acceleration Response, SA (short-period, or 0.2 sec)</i>	<i>Spectral Acceleration Response, SA (long-period or 1.0 sec)</i>
Low	less than 0.167 g (in horizontal direction)	less than 0.067 g (in horizontal direction)
Moderate	greater than or equal to 0.167 g but less than 0.500 g (in horizontal direction)	greater than or equal to 0.067 g but less than 0.200 g (in horizontal direction)
High	greater than or equal to 0.500 g (in horizontal direction)	greater than or equal to 0.200 g (in horizontal direction)

Notes: *g* = acceleration of gravity

2.4.2 Determination of Key Seismic Code Adoption Dates and Other Considerations

The Data Collection Form is meant to be a model that may be adopted and used as it is presented in this *Handbook*. The form may also be modified according to the needs of the RVS authority. Therefore, another aspect of the screening planning process is to review the Data Collection Form to determine if all required data are represented or if modifications should be made to reflect the needs and special circumstances of the authority. For example, an RVS authority may choose to define additional occupancy classes such as “parking structure” or “multi-family residential.”

One of the key issues that must be addressed in the planning process is the determination of (1) the year in which seismic codes were initially

Table 2-2. Benchmark Years for RVS Procedure Building Types (based on FEMA 310)

<u>Building Type</u>	<u>Model Building Seismic Design Provisions</u>			
	<u>BOCA</u>	<u>SBCC</u>	<u>UBC</u>	<u>NEHRP</u>
W1: Light wood-frame residential and commercial buildings smaller than or equal to 5,000 square feet	1992	1993	1976	1985
W2: Light wood-frame buildings larger than 5,000 square feet	1992	1993	1976	1985
S1: Steel moment-resisting frame buildings	**	**	1994	**
S2: Braced steel frame buildings	1992	1993	1988	1991
S3: Light metal buildings	*	*	*	*
S4: Steel frame buildings with cast-in-place concrete shear walls	1992	1993	1976	1985
S5: Steel frame buildings with unreinforced masonry infill walls	*	*	*	*
C1: Concrete moment-resisting frame buildings	1992	1993	1976	1985
C2: Concrete shear-wall buildings	1992	1993	1976	1985
C3: Concrete frame buildings with unreinforced masonry infill walls	*	*	*	*
PC1: Tilt-up buildings	*	*	1997	*
PC2: Precast concrete frame buildings	*	*	*	*
RM1: Reinforced masonry buildings with flexible floor and roof diaphragms	*	*	1997	*
RM2: Reinforced masonry buildings with rigid floor and roof diaphragms	1992	1993	1976	1985
URM: Unreinforced masonry bearing-wall buildings	*	*	1991	*

*No benchmark year; **contact local building department for benchmark year.

BOCA: Building Officials and Code Administrators, *National Building Code*

SBCC: Southern Building Code Congress, *Standard Building Code*.

UBC: International Conference of Building Officials, *Uniform Building Code*

NEHRP: National Earthquake Hazard Reduction Program, *FEMA 302 Recommended Provisions for the Development of Seismic Regulations for New Buildings*

adopted and enforced by the local jurisdiction, and (2) the year in which significantly improved seismic codes were adopted and enforced (this latter year is known as the benchmark year). In high and moderate seismicity regions, the Basic Structural Hazard Scores for the various building types are calculated for buildings built after the initial adoption of seismic codes, but before substantially improved codes were adopted. For these regions, Score Modifiers designated as “Pre Code” and “Post Benchmark” are provided, respectively, for buildings built before the adoption of codes and for buildings built after the adoption of substantially improved codes. In low seismicity regions, the Basic Structural Hazard Scores are calculated for buildings built before the initial adoption of seismic codes. For buildings in these regions, the Score Modifier designated as “Pre Code” is not applicable (N/A), and the Score Modifier designated as “Post Benchmark” is applicable for buildings built after the adoption of seismic codes.

Therefore, as part of this review process, the RVS authority should identify (1) the year in which seismic codes were first adopted and enforced in the area to be screened, (2) the “benchmark” year in which significantly improved seismic code requirements were adopted for each building type considered by the RVS procedure (see Table 2-2), and (3) the year in which the community adopted seismic anchorage requirements for heavy cladding. If the RVS authority in high and moderate seismicity regions is unsure of the year(s) in which codes were initially adopted, the default year for all but one building type is 1941 (the default year specified in the HAZUS criteria; NIBS, 1999). The one exception is PC1 (tilt-up) buildings, for which it is assumed that seismic codes were initially adopted in 1973, the year in which wall-diaphragm (ledger) connection requirements first appeared in the *Uniform Building Code* (ICBO, 1973).

During the review of the Data Collection Form, the RVS authority should confer with the

1. Model Building Types and Critical Code Adoption and Enforcement Dates		Year Seismic Codes Initially Adopted and Enforced*	Benchmark Year When Codes Improved
Structure Types			
W1	Light wood frame, residential or commercial, ≤ 5000 square feet	_____	_____
W2	Wood frame buildings, > 5000 square feet	_____	_____
S1	Steel moment-resisting frame	_____	_____
S2	Steel braced frame	_____	_____
S3	Light metal frame	_____	_____
S4	Steel frame with cast-in-place concrete shear walls	_____	_____
S5	Steel frame with unreinforced masonry infill	_____	_____
C1	Concrete moment-resisting frame	_____	_____
C2	Concrete shear wall	_____	_____
C3	Concrete frame with unreinforced masonry infill	_____	_____
PC1	Tilt-up construction	_____	_____
PC2	Precast concrete frame	_____	_____
RM1	Reinforced masonry with flexible floor and roof diaphragms	_____	_____
RM2	Reinforced masonry with rigid diaphragms	_____	_____
URM	Unreinforced masonry bearing-wall buildings	_____	_____
*Not applicable in regions of low seismicity			

2. Anchorage of Heavy Cladding Year in which seismic anchorage requirements were adopted: _____

Figure 2-3 Sections 1 and 2 of Quick Reference Guide (for use with Data Collection Form).

chief building official, plan checkers, and other design professionals experienced in seismic design to identify the years in which the affected jurisdiction initially adopted and enforced seismic codes (if ever) for the building lateral-force-resisting structural systems considered by the RVS procedure. Since municipal codes are generally adopted by the city council, another source for this information, in many municipalities, is the city clerk’s office. In addition to determining the year in which seismic codes were initially adopted and enforced, the RVS authority should also determine (1) the benchmark years in which substantially improved seismic codes were adopted and enforced for the various lateral-load-resisting systems and (2) the year in which anchorage requirements for cladding were adopted and enforced. These dates should be inserted on the Quick Reference Guide (Appendix B) that has been created to facilitate the use of the Data Collection Form (see Figure 2-3).

During the Data Collection Form review process, it is critically important that the Basic Structural Hazard Scores and Score Modifiers, which are described in detail in Chapter 3, not be changed without input from professional engineers familiar with earthquake-resistant design and

construction practices of the local community. A checklist of issues to be considered when reviewing the Data Collection Form is provided in Table 2-3.

Table 2-3 Checklist of Issues to be Considered During Pre-Field Work Review of the Data Collection Form

- Evaluate completeness of occupancy categories and appropriateness of occupancy loads
- Determine year in which seismic codes were initially adopted in the jurisdiction
- Determine “benchmark” years in which the jurisdiction adopted and enforced significantly improved seismic codes for the various building types considered by the RVS procedure
- Determine year in which the jurisdiction adopted and enforced anchorage requirements for heavy cladding

2.4.3 Determination of Cut-Off Score

Use of the RVS on a community-wide basis enables the RVS authority to divide screened buildings into two categories: those that are expected to have acceptable seismic performance, and those that may be seismically hazardous and

should be studied further. This requires that the RVS authority determine, preferably as part of the pre-planning process, an appropriate “cut-off” score.

An *S* score of 2 is suggested as a “cut-off”, based on present seismic design criteria. Using this cut-off level, buildings having an *S* score of 2 or less should be investigated by a design professional experienced in seismic design (see Section 3.9, 4.1 and 4.2 for additional information on this issue).

2.5 Qualifications and Training for Screeners

It is anticipated that a training program will be required to ensure a consistent, high quality of the data and uniformity of decisions among screeners. Training should include discussions of lateral-force-resisting systems and how they behave when subjected to seismic loads, how to use the Data Collection Form, what to look for in the field, and how to account for uncertainty. In conjunction with a professional engineer experienced in seismic design, screeners should simultaneously consider and score buildings of several different types and compare results. This will serve as a “calibration” for the screeners.

This process can easily be accomplished in a classroom setting with photographs of actual buildings to use as examples. Prospective screeners review the photographs and perform the RVS procedure as though they were on the sidewalk. Upon completion, the class discusses the results and students can compare how they did in relation to the rest of the class.

2.6 Acquisition and Review of Pre-Field Data

Information on the structural system, age or occupancy (that is, use) may be available from supplemental sources. These data, from assessor and building department files, insurance (Sanborn) maps, and previous studies, should be reviewed and collated for a given area before commencing the field survey for that area. It is recommended that this supplemental information either be written directly on the Data Collection Forms as it is retrieved or be entered into a computerized database. The advantage of a database is that selected information can be printed in a report format that can be taken into the field, or printed onto peel-off labels that can be affixed to the Data Collection Form (see Figure 2-4). In addition, screening data can be added to the databases and

Address:	_____
	Zip _____
Other Identifiers	_____
No. Stories	Year Built _____
Screened	Date _____
Total Floor Area (sq. ft.)	_____
Building Name	_____
Use	_____

Rapid Visual Screening of Buildings for Potential Seismic Hazards
FEMA-154 Data Collection Form

HIGH Seismicity

Address: _____	
Zip _____	
Other Identifiers _____	
No. Stories	Year Built _____
Screened	Date _____
Total Floor Area (sq. ft.)	_____
Building Name	_____
Use	_____
PHOTOGRAPH	
Scale: _____	

OCCUPANCY	SOIL			TYPE							FALLING HAZARDS				
	A	B	C	A	B	C	D	E	F	G	H	I	J	K	L
Assessors	Govt	Office	Number of Persons												
Commercial	Hotel	Residential	(1-10												
Other Services	Industrial	School	101-1000												
			1000+												

BASIC SCORE, MODIFIERS, AND FINAL SCORE, S

BUILDING TYPE	W1	W2	S1	S2	S3	S4	S5	CT1	CT2	CT3	PC1	PC2	PC3	PC4	PC5	PC6
Steel Frame	4.4	3.8	2.8	3.2	3.2	2.8	2.8	2.8	2.8	1.8	2.8	2.4	2.8	2.8	2.8	1.8
Mid-Rise (4 to 7 stories)	NA	NA	-0.2	-0.4	NA	-0.4	-0.4	-0.4	-0.4	-0.2	NA	-0.2	-0.4	-0.4	-0.4	3.0
High-Rise (8+ stories)	NA	NA	-0.6	-0.8	NA	-0.8	-0.8	-0.8	-0.8	-0.6	NA	-0.6	-0.8	-0.8	-0.8	3.0
Vertical irregularity	-2.0	-2.0	-1.0	-1.0	NA	-1.0	-1.0	-1.0	-1.0	-1.0	-1.0	-1.0	-1.0	-1.0	-1.0	-1.0
Plan irregularity	-0.9	-0.9	-0.5	-0.5	-0.5	-0.5	-0.5	-0.5	-0.5	-0.5	-0.5	-0.5	-0.5	-0.5	-0.5	-0.5
PreCode	-0.9	-1.0	-1.0	-0.8	-0.8	-0.8	-0.8	-0.2	-1.2	-1.2	-0.8	-0.8	-1.0	-0.8	-1.0	-0.8
Post-Code	-0.4	-0.4	-1.0	-1.0	NA	-1.0	NA	-1.0	-0.4	-0.4	NA	-0.4	NA	-0.8	-0.8	NA
Soil Type C	0.0	-0.4	-0.4	-0.4	-0.4	-0.4	-0.4	-0.4	-0.4	-0.4	-0.4	-0.4	-0.4	-0.4	-0.4	-0.4
Soil Type D	0.0	0.0	-0.6	-0.6	-0.6	-0.6	-0.6	-0.6	-0.6	-0.6	-0.6	-0.6	-0.6	-0.6	-0.6	-0.6
Soil Type F	0.0	-0.8	-1.2	-1.2	-1.2	-1.2	-1.2	-1.2	-1.2	-1.2	-1.2	-1.2	-1.2	-1.2	-1.2	-1.2

FINAL SCORE, S

COMMENTS _____

Detailed Evaluation Required
YES NO

* = Estimated, subjective, or unreliable data
NA = Not Applicable
S1 = Steel frame
S2 = Concrete/brick
S3 = Light metal
S4 = Reinforced concrete
S5 = Reinforced masonry
CT1 = Steel wall
CT2 = Brick wall
CT3 = Concrete
CT4 = Masonry
PC1 = Flagpole
PC2 = Chimney
PC3 = Tower
PC4 = Staircase
PC5 = Elevator
PC6 = Other

Figure 2-4 Building identification portion of RVS Data Collection Form.

used to generate maps and reports. Some sources of supplemental information are described in Sections 2.6.1 through 2.6.5.

2.6.1 Assessor's Files

Although assessor's files may contain information about the age of the building, the floor area and the number of stories, most information relates to ownership and assessed value of the land and improvements, and thus is of relatively little value for RVS purposes. The construction type indicated is often incorrect and in most cases should not be used. In addition, the age of a building retrieved from assessor's files may not, and most likely is not, the year that the structure was built. Usually assessor's files contain the year that the building was first eligible for taxation. Because the criteria for this may vary, the date may be several years after the building was designed or constructed. If no other source of information is available this will give a good estimate of the period during which the building

was constructed. However, this date should not be used to establish conclusively the code under which the a building was designed. Assessor's offices may have parcel or lot maps, which may be useful for locating sites or may be used as a template for sketching building adjacencies on a particular city block.

2.6.2 Building Department Files

The extent and completeness of information in building department files will vary from jurisdiction to jurisdiction. For example, in some locations all old files have been removed or destroyed, so there is no information on older buildings. In general, files (or microfilm) may contain permits, plans and structural calculations required by the city. Sometimes there is occupancy and use information, but little information about structural type will be found except from the review of plans or calculations.

2.6.3 Sanborn Maps

These maps, published primarily for the insurance industry since the late 1800s, exist for about 22,000 communities in the United States. The Sanborn Map Company stopped routinely updating these maps in the early 1960s, and many communities have not kept these maps up-to-date. Thus they may not be useful for newer construction. However, the maps may contain useful data for older construction. They can be found at the library or in some cases in building department offices. Figure 2-5 provides an example of an up-to-date Sanborn map. Figure 2-6 shows a key to identifiers on Sanborn maps.

Information found on a Sanborn map includes:

- height of building,
- number of stories,
- year built,
- thickness of walls,
- building size (square feet),
- type of roof (tile, shingle, composite),
- building use (dwelling, store, apartment),
- presence of garage under structure, and
- structural type (wood frame, fireproof construction, adobe, stone, concrete).

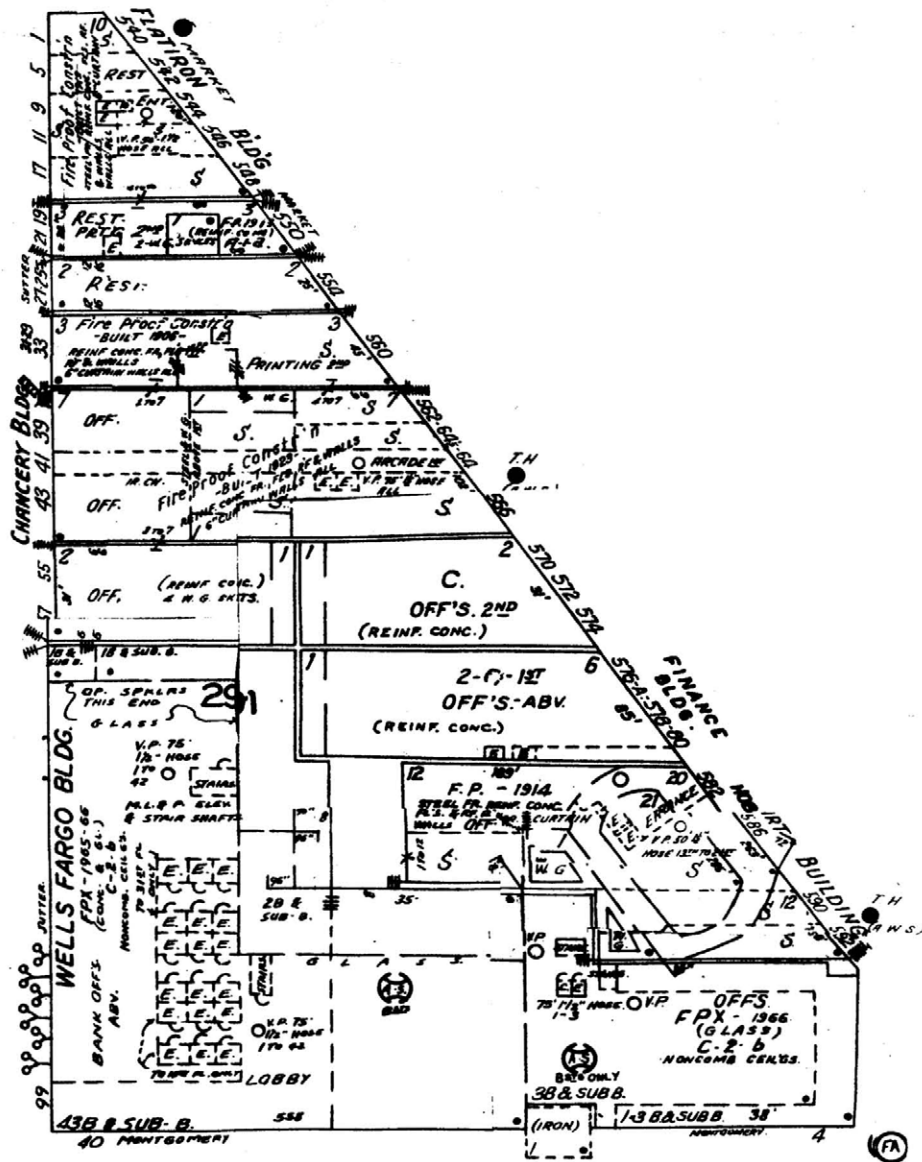

Figure 2-5 Example Sanborn map showing building information for a city block.

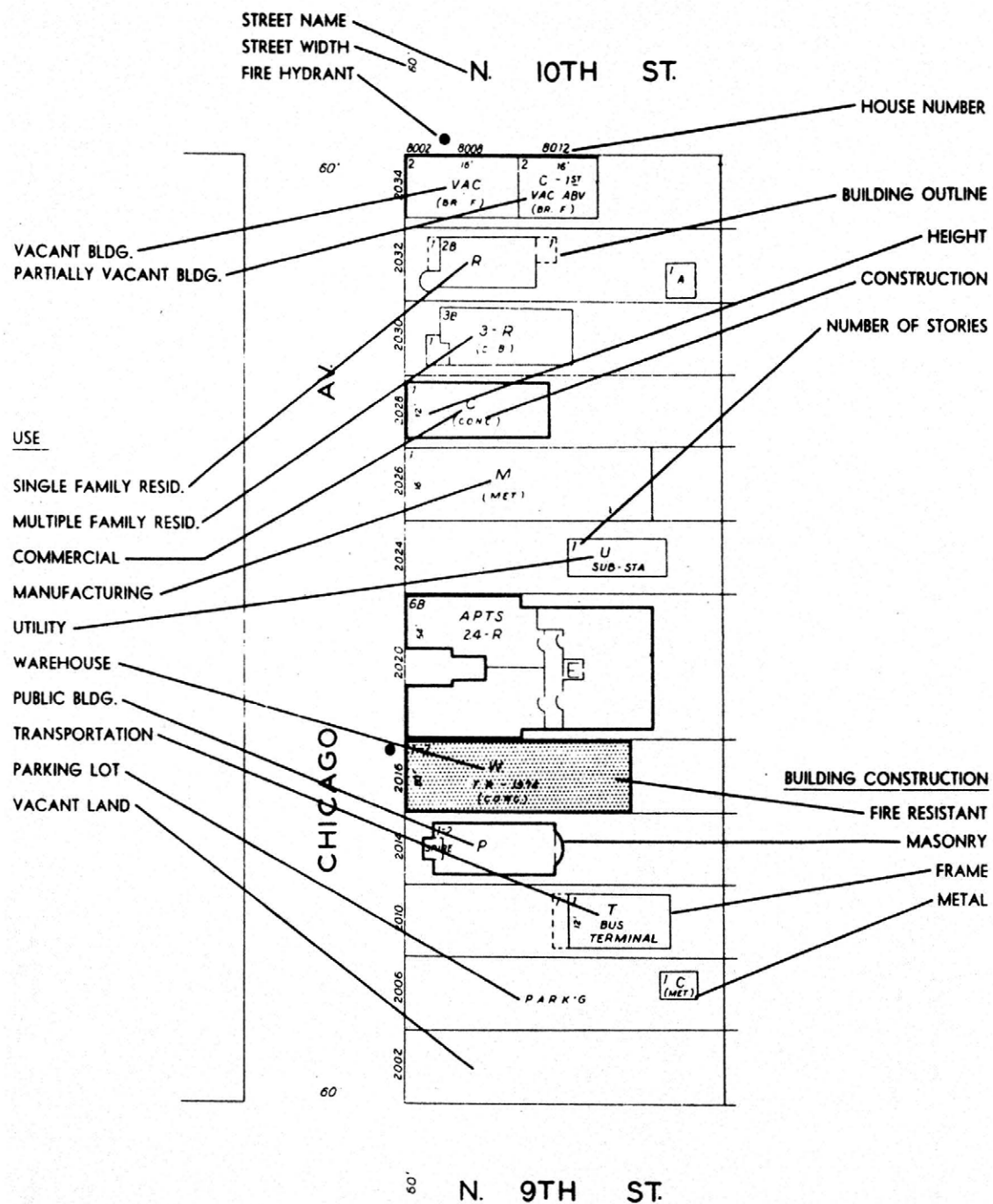
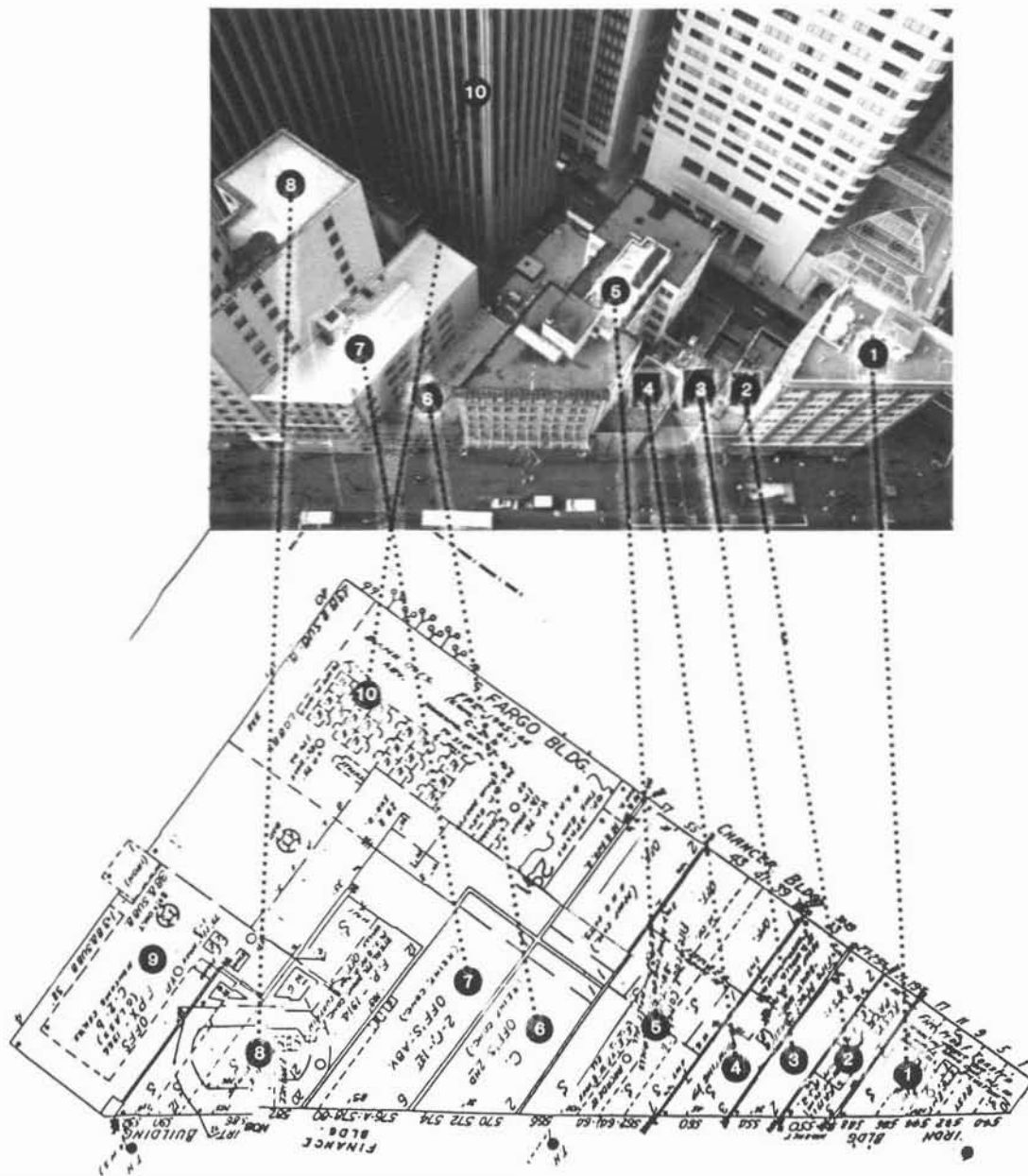

Figure 2-6 Key to Sanborn map symbols. Also, see the Internet, www.sanbornmap.com.

Parcel maps are also available and contain lot dimensions. If building size information cannot be obtained from another source such as the assessor's file, the parcel maps are particularly helpful for determining building dimensions in urban areas where buildings cover the entire lot.

However, even if the building does not cover the entire lot, it will be easier to estimate building dimensions if the lot dimensions are known.

Figures 2-7 and 2-8 show a Sanborn map and photographs of a city block. Building descriptions obtained from the Sanborn maps are also included.



1. 10 story commercial office
2. 3 story commercial, built 1913
3. 2 story commercial
4. 3 story commercial, reinforced concrete frame, built 1906
5. 7 story commercial office, reinforced concrete frame, built 1923
6. 2 story commercial, reinforced concrete
7. 5 story commercial office, reinforced concrete
8. 20 story commercial office, steel frame with reinforced concrete, built 1914
9. 4 story commercial, built 1966
10. 40 story commercial office, built 1965-66, concrete and glass exterior

Figure 2-7 Sanborn map and corresponding aerial photograph of a city block.

Although the information on Sanborn maps may be useful, it is the responsibility of the screener to verify it in the field.

2.6.4 *Municipal Databases*

With the widespread use of the internet, many jurisdictions are creating “on-line” electronic databases for use by the general public. These databases provide general information on the various building sites within the jurisdiction. These databases are not detailed enough at this point in time to provide specific information about the buildings; they do, however, provide some good demographic information that could be of use. As the municipalities develop more comprehensive information, these databases will become more useful to the RVS screening. Figure 2-9 shows examples of the databases from two municipalities in the United States.

2.6.5 *Previous Studies*

In a few cases, previous building inventories or studies of hazardous buildings or hazardous non-structural elements (e.g., parapets) may have been performed. These studies may be limited to a particular structural or occupancy class, but they may contain useful maps or other relevant structural information and should be reviewed. Other important studies might address related seismic hazard issues such as liquefaction or landslide potential. Local historical societies may have published books or reports about older buildings in the community. Fire departments are often aware of the overall condition and composition of building interiors.

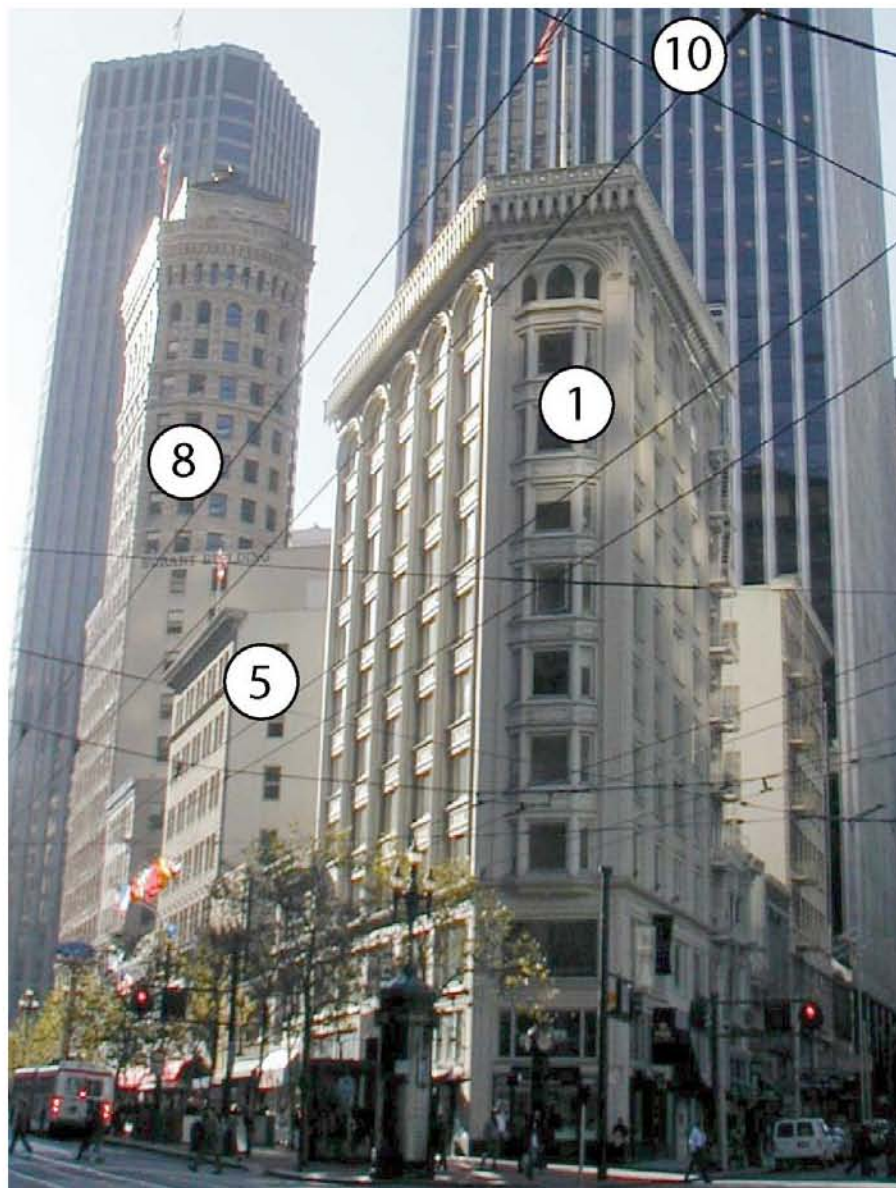
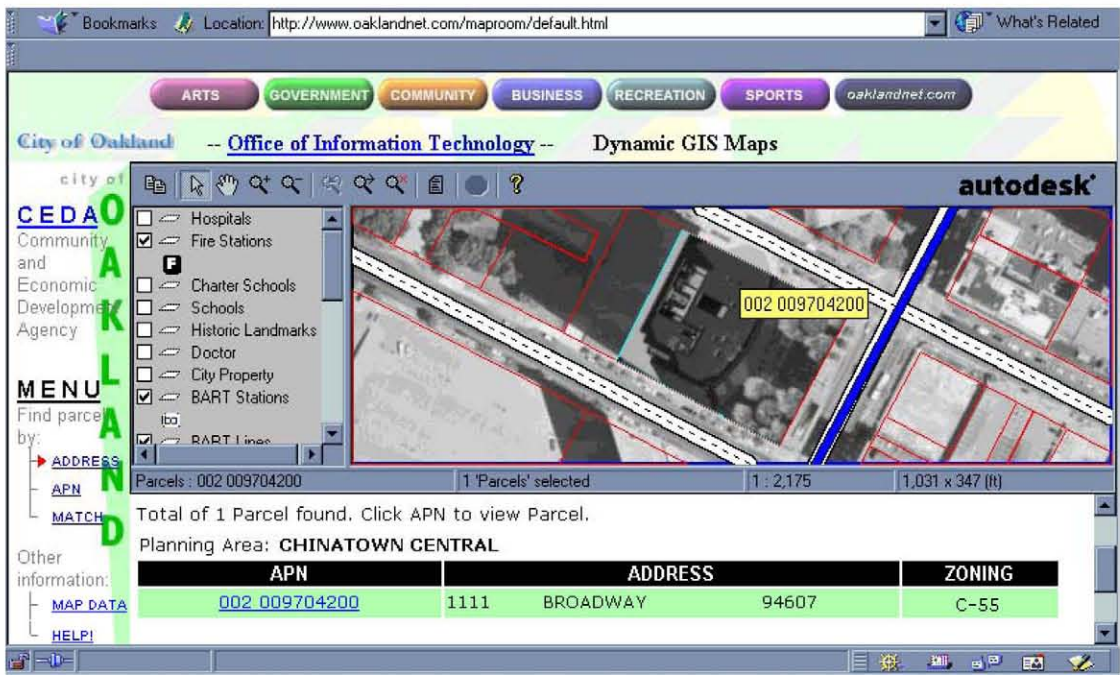

Figure 2-8 Photographs of elevation views of buildings shown in Figure 2-7.

2.6.6 *Soils Information*

Soil type has a major influence on amplitude and duration of shaking, and thus structural damage. Generally speaking, the deeper the soils at a site, the more damaging the earthquake motion will be. The six soil types considered in the RVS procedure are the same as those specified in the FEMA 302 report, *NEHRP Recommended Provisions for the Seismic Design of New Buildings and Other Structures* (BSSC, 1997): hard rock (type A); average rock (type B); dense soil (type C), stiff soil (type D); soft soil (type E), and poor soil (type F). Additional information on these soil types and how to identify



City of Oakland, California

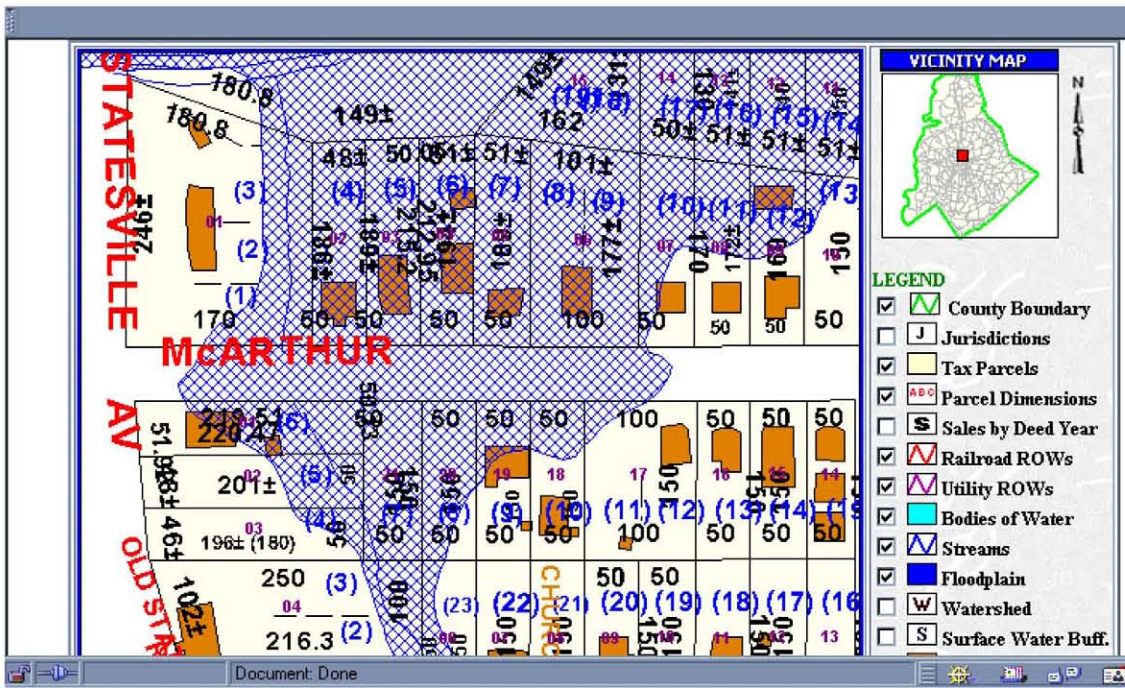

Mecklenburg County, North Carolina

Figure 2-9 Examples of in-house screen displays of municipal databases.

SOIL TYPE					
A	B	C	D	E	F
Hard Rock	Avg. Rock	Dense Soil	Stiff Soil	Soft Soil	Poor Soil

Rapid Visual Screening of Buildings for Potential Seismic Hazards
FEMA 154 Data Collection Form

HIGH Seismicity

<p>Scale: _____</p> <p>PHOTOGRAPH</p>	Address: _____ Zip: _____
	Other Identifiers: _____
	No. Stories: _____ Year Built: _____
	Screened: _____ Date: _____
	Total Floor Area (sq. ft.): _____ Building Name: _____

OCCUPANCY	SOIL	TYPE	FALLING HAZARDS
<input type="checkbox"/> Commercial <input type="checkbox"/> Industrial <input type="checkbox"/> Educational <input type="checkbox"/> Residential <input type="checkbox"/> Other	<input type="checkbox"/> A <input type="checkbox"/> B <input type="checkbox"/> C <input type="checkbox"/> D <input type="checkbox"/> E <input type="checkbox"/> F	<input type="checkbox"/> 1 <input type="checkbox"/> 2 <input type="checkbox"/> 3 <input type="checkbox"/> 4 <input type="checkbox"/> 5 <input type="checkbox"/> 6 <input type="checkbox"/> 7 <input type="checkbox"/> 8 <input type="checkbox"/> 9 <input type="checkbox"/> 10 <input type="checkbox"/> 11 <input type="checkbox"/> 12 <input type="checkbox"/> 13 <input type="checkbox"/> 14 <input type="checkbox"/> 15 <input type="checkbox"/> 16 <input type="checkbox"/> 17 <input type="checkbox"/> 18 <input type="checkbox"/> 19 <input type="checkbox"/> 20 <input type="checkbox"/> 21 <input type="checkbox"/> 22 <input type="checkbox"/> 23 <input type="checkbox"/> 24 <input type="checkbox"/> 25 <input type="checkbox"/> 26 <input type="checkbox"/> 27 <input type="checkbox"/> 28 <input type="checkbox"/> 29 <input type="checkbox"/> 30 <input type="checkbox"/> 31 <input type="checkbox"/> 32 <input type="checkbox"/> 33 <input type="checkbox"/> 34 <input type="checkbox"/> 35 <input type="checkbox"/> 36 <input type="checkbox"/> 37 <input type="checkbox"/> 38 <input type="checkbox"/> 39 <input type="checkbox"/> 40 <input type="checkbox"/> 41 <input type="checkbox"/> 42 <input type="checkbox"/> 43 <input type="checkbox"/> 44 <input type="checkbox"/> 45 <input type="checkbox"/> 46 <input type="checkbox"/> 47 <input type="checkbox"/> 48 <input type="checkbox"/> 49 <input type="checkbox"/> 50	<input type="checkbox"/> None <input type="checkbox"/> Low <input type="checkbox"/> Medium <input type="checkbox"/> High

BASIC SCORE, MODIFIERS, AND FINAL SCORE, S														
BUILDING TYPE	M1	M2	M3	M4	M5	M6	M7	M8	M9	M10	M11	M12	M13	M14
Basic Score	4.4	5.8	5.8	5.8	5.2	5.8	5.2	5.8	5.8	5.8	5.8	5.8	5.8	5.8
Modification 1 of 7 Factors	0.0	0.0	-0.2	-0.4	0.0	-0.4	-0.4	-0.4	-0.2	0.0	-0.2	0.0	-0.2	-0.4
Modification 2 of 7 Factors	0.0	0.0	-0.2	-0.4	0.0	-0.4	-0.4	-0.4	-0.2	0.0	-0.2	0.0	-0.2	-0.4
Vertical Irregularity	2.5	2.0	1.2	1.0	0.0	1.0	1.0	1.0	1.0	1.0	1.0	1.0	1.0	1.0
Plan Irregularity	0.0	0.0	0.0	0.0	0.0	0.0	0.0	0.0	0.0	0.0	0.0	0.0	0.0	0.0
Plan Choke	0.0	1.0	0.0	0.0	0.0	0.0	0.0	0.0	0.0	0.0	0.0	0.0	0.0	0.0
Plan Symmetry	-0.4	-0.4	-0.4	-0.4	0.0	-0.4	-0.4	-0.4	0.0	-0.4	-0.4	-0.4	-0.4	-0.4
Top Type C	0.0	0.0	0.0	0.0	0.0	0.0	0.0	0.0	0.0	0.0	0.0	0.0	0.0	0.0
Soil Type D	0.0	-0.4	-0.4	-0.4	0.0	0.0	0.0	0.0	0.0	0.0	0.0	0.0	0.0	0.0
Soil Type E	0.0	-0.4	-0.4	-0.4	0.0	0.0	0.0	0.0	0.0	0.0	0.0	0.0	0.0	0.0
Soil Type F	0.0	-0.4	-0.4	-0.4	0.0	0.0	0.0	0.0	0.0	0.0	0.0	0.0	0.0	0.0
FINAL SCORE, S	4.4	5.8	5.2	5.2	5.2	5.8	5.2	5.8	5.8	5.8	5.8	5.8	5.8	5.8

COMMENTS: _____

Detailed Evaluation Required
YES NO

Figure 2-10 Location on Data Collection Form where soil type information is recorded.

them are provided in the side bar. Buildings on soil type F cannot be screened effectively by the RVS procedure, other than to recommend that buildings on this soil type be further evaluated by a geotechnical engineer and design professional experienced in seismic design.

Since soil conditions cannot be readily identified by visual methods in the field, geologic and geotechnical maps and other information should be collected during the planning stage and put into a readily usable map format for use during RVS. During the screening, or the planning stage, this soil type should also be documented on the Data Collection Form by circling the correct soil type, as designated by the letters A through F, (see Figure 2-10). If sufficient guidance or data are not available during the planning stage to classify the soil type as A through E, a soil type E should be assumed. However, for one-story or two-story buildings with a roof height equal to or less than 25 feet, a class D soil type may be assumed when site conditions are not known. (See the note in preceding paragraph regarding soil type F.)

2.7 Review of Construction Documents

Whenever possible, design and construction documents should be reviewed prior to the

Soil Type Definitions and Related Parameters

The six soil types, with measurable parameters that define each type, are:

Type A (hard rock): measured shear wave velocity, $v_s > 5000$ ft/sec.

Type B (rock): v_s between 2500 and 5000 ft/sec.

Type C (soft rock and very dense soil): v_s between 1200 and 2500 ft/sec, or standard blow count $N > 50$, or undrained shear strength $s_u > 2000$ psf.

Type D (stiff soil): v_s between 600 and 1200 ft/sec, or standard blow count N between 15 and 50, or undrained shear strength, s_u between 1000 and 2000 psf.

Type E (soft soil): More than 100 feet of soft soil with plasticity index $PI > 20$, water content $w > 40\%$, and $s_u < 500$ psf; or a soil with $v_s \leq 600$ ft/sec.

Type F (poor soil): Soils requiring site-specific evaluations:

- Soils vulnerable to potential failure or collapse under seismic loading, such as liquefiable soils, quick and highly-sensitive clays, collapsible weakly-cemented soils.
- Peats or highly organic clays ($H > 10$ feet of peat or highly organic clay, where H = thickness of soil.).
- Very high plasticity clays ($H > 25$ feet with $PI > 75$).
- More than 120 ft of soft or medium stiff clays.

The parameters v_s , N , and s_u are, respectively, the average values (often shown with a bar above) of shear wave velocity, Standard Penetration Test (SPT) blow count and undrained shear strength of the upper 100 feet of soils at the site.

conduct of field work to help the screener identify the type of lateral-force-resisting system for each building. The review of construction documents to identify the building type substantially improves the confidence in this determination. As described in Section 3.7, the RVS procedure requires that each building be identified as one of 15 model building types². Guidance for reviewing design and construction drawings is provided in Appendix C.

²The 15 model building types used in FEMA 154 are an abbreviated list of the 22 types now considered standard by FEMA; excluded from the FEMA 154 list are sub-classifications of certain framing types that specify that the roof and floor diaphragms are either rigid or flexible.

2.8 Field Screening of Buildings

RVS screening of buildings in the field should be carried out by teams consisting of two individuals. Teams of two are recommended to provide an opportunity to discuss issues requiring judgment and to facilitate the data collection process. If at all possible, one of the team members should be a design professional who can identify lateral-force-resisting systems.

Relatively few tools or equipment are needed. Table 2-4 contains a checklist of items that may be needed in performing an RVS as described in this *Handbook*.

2.9 Checking the Quality and Filing the Field Data in the Record-Keeping System

The last step in the implementation of rapid visual screening is checking the quality and filing the RVS data in the record-keeping system established for this purpose. If the data are to be stored in file folders or envelopes containing data for each building that was screened, or on microfilm, the process is straightforward, and requires careful organization. If the data are to be stored in digital form, it is important that the data input and verification process include either double entry of

all data, or systematic in-depth review of print outs (item by item review) of all entered data.

It is also recommended that the quality review be performed under the oversight of a design professional with significant experience in seismic design.

Table 2-4 Checklist of Field Equipment Needed for Rapid Visual Screening

- Binoculars, if high-rise buildings are to be evaluated
 - Camera, preferably instant or digital
 - Clipboard for holding Data Collection Forms
 - Copy of the FEMA 154 *Handbook*
 - Laminated version of the Quick Reference Guide defining terms used on the Data Collection Form (see Appendix B)
 - Pen or pencil
 - Straight edge (optional for drawing sketches)
 - Tape or stapler, for affixing photo if instant camera is used
-

Chapter 3

Completing the Data Collection Form

3.1 Introduction

This chapter provides instructions on how to complete the Data Collection Form (Figure 3-1). It is assumed that the Data Collection Form has already been selected, based on the seismicity level of the area to be screened (as per Chapter 2). The Data Collection Form is completed for each building screened through execution of the following steps:

1. Verifying and updating the building identification information;
2. Walking around the building to identify its size and shape, and sketching a plan and elevation view on the Data Collection Form;
3. Determining and documenting occupancy;
4. Determining soil type, if not identified during the pre-planning process;
5. Identifying potential nonstructural falling hazards, if any, and indicating their existence on the Data Collection Form;
6. Identifying the seismic lateral-load resisting system (entering the building, if possible, to facilitate this process) and circling the related Basic Structural Hazard Score on the Data Collection Form;
7. Identifying and circling the appropriate seismic performance attribute Score Modifiers (e.g., number of stories, design date, and soil type) on the Data Collection Form;
8. Determining the Final Score, *S* (by adjusting the Basic Structural Hazard Score with the Score Modifiers identified in Step 7), and deciding if a detailed evaluation is required; and
9. Photographing the building and attaching the photo to the form (if an instant camera is

Rapid Visual Screening of Buildings for Potential Seismic Hazards
FEMA-154 Data Collection Form

HIGH Seismicity

	Address: _____ Zip _____ Other Identifiers _____ No. Stories _____ Year Built _____ Screener _____ Date _____ Total Floor Area (sq. ft.) _____ Building Name _____ Use _____
	PHOTOGRAPH

	OCCUPANCY	SOIL	TYPE	FALLING HAZARDS											
Assembly Commercial Emer. Services	Govt Historic Industrial	Office Residential School	Number of Persons 0 - 10 11 - 100 101-1000 1000+	A Hard Rock B Avg. Rock C Dense Soil D Stiff Soil E Soft Soil F Poor Soil	<input type="checkbox"/> Unreinforced Chimneys <input type="checkbox"/> Parapets <input type="checkbox"/> Cladding <input type="checkbox"/> Other:										
BASIC SCORE, MODIFIERS, AND FINAL SCORE, S															
BUILDING TYPE	W1	W2	S1 (MRF)	S2 (BR)	S3 (LM)	S4 (RC SW)	S5 (URM INF)	C1 (MRF)	C2 (SW)	C3 (URM INF)	PC1 (TU)	PC2	RM1 (FD)	RM2 (RD)	URM
Basic Score	4.4	3.8	2.8	3.0	3.2	2.8	2.0	2.5	2.8	1.6	2.6	2.4	2.8	2.8	1.8
Mid Rise (4 to 7 stories)	N/A	N/A	+0.2	+0.4	N/A	+0.4	+0.4	+0.4	+0.2	N/A	+0.2	+0.4	+0.4	0.0	
High Rise (> 7 stories)	N/A	N/A	+0.6	+0.8	N/A	+0.8	+0.8	+0.6	+0.8	+0.3	N/A	+0.4	N/A	+0.6	
Vertical Irregularity	-2.5	-2.0	-1.0	-1.5	N/A	-1.0	-1.0	-1.5	-1.0	-1.0	N/A	-1.0	-1.0	-1.0	
Plan Irregularity	-0.5	-0.5	-0.5	-0.5	-0.5	-0.5	-0.5	-0.5	-0.5	-0.5	-0.5	-0.5	-0.5	-0.5	
Pre-Code	0.0	-1.0	-1.0	-0.8	-0.6	-0.8	-0.2	-1.2	-1.0	-0.2	-0.8	-0.8	-1.0	-0.8	
Post-Benchmark	+2.4	+2.4	+1.4	N/A	+1.6	N/A	+1.4	+2.4	N/A	+2.4	N/A	+2.8	+2.6	N/A	
Soil Type C	0.0	-0.4	-0.4	-0.4	-0.4	-0.4	-0.4	-0.4	-0.4	-0.4	-0.4	-0.4	-0.4	-0.4	
Soil Type D	0.0	-0.8	-0.6	-0.6	-0.6	-0.6	-0.4	-0.6	-0.6	-0.4	-0.6	-0.6	-0.6	-0.6	
Soil Type E	0.0	-0.8	-1.2	-1.2	-1.0	-1.2	-0.8	-1.2	-0.8	-0.8	-0.4	-1.2	-0.4	-0.6	
FINAL SCORE, S															
COMMENTS														Detailed Evaluation Required YES NO	

* = Estimated, subjective, or unreliable data BR = Braced frame MRF = Moment-resisting frame SW = Shear wall
 DNK = Do Not Know FD = Flexible diaphragm RC = Reinforced concrete TU = Tilt up
 LM = Light metal RD = Rigid diaphragm URM INF = Unreinforced masonry infill

Figure 3-1 Example RVS Data Collection Form (high seismicity).

used), or indicating a photo reference number on the form (if a digital camera is used).

Full-sized copies of the Data Collection Forms (one for each seismicity region) are provided in Appendix B, along with a Quick Reference Guide defining terms used on the Data Collection Form. The form has been designed to be filled out in a progressive manner, with a minimum of writing (most items simply can be circled).

Following are detailed instructions and guidance for each of the nine steps above.

3.2 Verifying and Updating the Building Identification Information

Space is provided in the upper right-hand portion of the Data Collection Form (see Figure 3-2) to document building identification information (i.e., address, name, number of stories, year built, and other data). As indicated in Chapter 2, it is desirable to develop and document this information during the pre-planning stage, if at all possible. This information may be entered manually, or be printed on a peel-off label.

Proper identification and location of the building is critically important for subsequent use in hazard assessment and mitigation by the RVS authority. As described in Chapter 2, the authority may prefer to identify and file structures by street address, parcel number, building owner, or some other scheme. However, it is recommended that as a minimum the street address and zip code be recorded on the form. Zip code is important because it is universal to all municipalities, is an especially useful item for later collation and summary analyses. Assessor parcel number or lot number is also useful for jurisdictional record-keeping purposes.

Assuming the identification information is provided on a peel-off label, which is then affixed to the form, or preprinted directly on the form, such information should be verified in the field. If the building identification data are not developed during the pre-planning stage, it must be completed in the field. Documentation of the building address information and name, if it exists, is straightforward. Following is guidance and discussion pertaining to number of stories, year built, identification of the screener, and estimation of total floor area.

3.2.1 Number of Stories

The height of a structure is sometimes related to the amount of damage it may sustain. On soft soils, a tall building may experience considerably stronger and longer duration shaking than a shorter building of the same type. The number of stories is a good indicator of the height of a building (approximately 9-to-10 feet per story for residential, 12 feet per story for commercial or office).

Counting the number of stories may not be a straightforward issue if the building is constructed on a hill or if it has several different roof levels. As a general rule, use the largest number (that is,

Address:	_____	Zip	_____
Other Identifiers	_____		
No. Stories	_____	Year Built	_____
Screener	_____	Date	_____
Total Floor Area (sq. ft.)	_____		
Building Name	_____		
Use	_____		

Figure 3-2 Portion of Data Collection Form for documenting building identification.

count floors from the downhill side to the roof). In addition, the number of stories may not be unique. A building may be stepped or have a tower. Use the comment section and the sketch to indicate variations in the number of stories.

3.2.2 Year Built

This information is one of the key elements of the RVS procedure. Building age is tied directly to design and construction practices. Therefore, age can be a factor in determining building type and thus can affect the final scores. This information is not typically available at the site and thus should be included in pre-field data collection.

There may be no single “year built.” Certain portions of the structure may have been designed and constructed before others. If this should be the case, the construction dates for each portion can be indicated in the comment section or on the sketch (see Section 3.3). Caution should also be used when interpreting design practices from date of construction. The building may have been designed several years before it was constructed and thus designed to an earlier code with different requirements for seismic detailing.

If information on “year built” is not available during the RVS pre-field data acquisition stage (see Section 2.6), a rough estimate of age will be made on the basis of architectural style and building use. This is discussed in more detail in Appendix D, which provides additional guidance on determining building attributes from streetside. If the year built is only an approximation, an asterisk is used to indicate the entry is estimated.

3.2.3 Screener Identification

The screener should be identified, by name, initials, or some other type of code. At some later time it may be important to know who the screener was for a particular building, so this information should not be omitted.

SKETCHES

Rapid Visual Screening of Buildings for Potential Seismic Hazards
FEMA-154 Data Collection Form

HIGH Seismicity

	Address: _____ Zip: _____ Other Identifiers _____ No. Stories _____ Year Built _____ Screener _____ Date _____ Total Floor Area (sq. ft.) _____ Building Name _____ Use _____																																																																																																																																																																																																					
PHOTOGRAPH																																																																																																																																																																																																						
Scale: _____																																																																																																																																																																																																						
<table border="1" style="width: 100%; border-collapse: collapse;"> <tr> <th colspan="2">OCCUPANCY</th> <th colspan="2">SOIL</th> <th colspan="2">TYPE</th> <th colspan="2">FALLING HAZARDS</th> </tr> <tr> <td>Assembly</td> <td>Govt.</td> <td rowspan="2">Number of Persons 0-10 11-100 101-1000 1000+</td> <td>A</td> <td>B</td> <td>C</td> <td>D</td> <td>E</td> <td>F</td> </tr> <tr> <td>Commercial</td> <td>Historic</td> <td>Hard Rock</td> <td>Avg. Dense Soil</td> <td>Stiff Soil</td> <td>Soft Soil</td> <td>Floor Soil</td> <td></td> </tr> <tr> <td>Emer. Services</td> <td>Industrial</td> <td>School</td> <td colspan="2"></td> <td colspan="2"></td> <td colspan="2"> <input type="checkbox"/> Unreinforced Chimneys <input type="checkbox"/> Parapets <input type="checkbox"/> Cladding <input type="checkbox"/> Other </td> </tr> </table>	OCCUPANCY		SOIL		TYPE		FALLING HAZARDS		Assembly	Govt.	Number of Persons 0-10 11-100 101-1000 1000+	A	B	C	D	E	F	Commercial	Historic	Hard Rock	Avg. Dense Soil	Stiff Soil	Soft Soil	Floor Soil		Emer. Services	Industrial	School					<input type="checkbox"/> Unreinforced Chimneys <input type="checkbox"/> Parapets <input type="checkbox"/> Cladding <input type="checkbox"/> Other																																																																																																																																																																					
OCCUPANCY		SOIL		TYPE		FALLING HAZARDS																																																																																																																																																																																																
Assembly	Govt.	Number of Persons 0-10 11-100 101-1000 1000+	A	B	C	D	E	F																																																																																																																																																																																														
Commercial	Historic		Hard Rock	Avg. Dense Soil	Stiff Soil	Soft Soil	Floor Soil																																																																																																																																																																																															
Emer. Services	Industrial	School					<input type="checkbox"/> Unreinforced Chimneys <input type="checkbox"/> Parapets <input type="checkbox"/> Cladding <input type="checkbox"/> Other																																																																																																																																																																																															
<table border="1" style="width: 100%; border-collapse: collapse; font-size: small;"> <tr> <th colspan="13">BASIC SCORE, MODIFIERS, AND FINAL SCORE, S</th> </tr> <tr> <th>BUILDING TYPE</th> <th>W1</th> <th>W2</th> <th>S1</th> <th>S2</th> <th>S3</th> <th>S4</th> <th>S5</th> <th>C1</th> <th>C2</th> <th>C3</th> <th>PC1</th> <th>PC2</th> <th>RM1</th> <th>RM2</th> <th>URM</th> </tr> <tr> <td>Basic Score</td> <td>4.4</td> <td>3.8</td> <td>3.0</td> <td>3.2</td> <td>2.8</td> <td>2.3</td> <td>2.5</td> <td>2.8</td> <td>1.8</td> <td>2.6</td> <td>2.4</td> <td>2.8</td> <td>2.8</td> <td>2.8</td> <td>1.8</td> </tr> <tr> <td>Mid Rise (4 to 7 stories)</td> <td>N/A</td> <td>N/A</td> <td>+0.2</td> <td>+0.4</td> <td>N/A</td> <td>+0.4</td> <td>+0.4</td> <td>+0.4</td> <td>+0.4</td> <td>+0.2</td> <td>N/A</td> <td>+0.2</td> <td>+0.4</td> <td>+0.4</td> <td>0.0</td> </tr> <tr> <td>High Rise (> 7 stories)</td> <td>N/A</td> <td>N/A</td> <td>+0.6</td> <td>+0.8</td> <td>N/A</td> <td>+0.8</td> <td>+0.8</td> <td>+0.8</td> <td>+0.8</td> <td>+0.3</td> <td>N/A</td> <td>+0.4</td> <td>N/A</td> <td>+0.6</td> <td>N/A</td> </tr> <tr> <td>Vertical Irregularity</td> <td>-2.5</td> <td>-2.0</td> <td>-1.0</td> <td>-1.5</td> <td>N/A</td> <td>-1.0</td> <td>-1.0</td> <td>-1.5</td> <td>-1.0</td> <td>-1.0</td> <td>N/A</td> <td>-1.0</td> <td>-1.0</td> <td>-1.0</td> <td>-1.0</td> </tr> <tr> <td>Plan Irregularity</td> <td>-0.5</td> <td>-0.5</td> <td>-0.5</td> <td>-0.5</td> <td>-0.5</td> <td>-0.5</td> <td>-0.5</td> <td>-0.5</td> <td>-0.5</td> <td>-0.5</td> <td>-0.5</td> <td>-0.5</td> <td>-0.5</td> <td>-0.5</td> <td>-0.5</td> </tr> <tr> <td>Pre-Code</td> <td>0.0</td> <td>-1.0</td> <td>-1.0</td> <td>-0.8</td> <td>-0.8</td> <td>-0.8</td> <td>-0.2</td> <td>-1.2</td> <td>-1.0</td> <td>-0.2</td> <td>-0.8</td> <td>-0.8</td> <td>-1.0</td> <td>-0.8</td> <td>-0.2</td> </tr> <tr> <td>Post-Benchmark</td> <td>+2.4</td> <td>+2.4</td> <td>+1.4</td> <td>+1.4</td> <td>N/A</td> <td>+1.6</td> <td>N/A</td> <td>+1.4</td> <td>+2.4</td> <td>N/A</td> <td>+2.4</td> <td>N/A</td> <td>+2.8</td> <td>+2.6</td> <td>N/A</td> </tr> <tr> <td>Soil Type C</td> <td>0.0</td> <td>-0.4</td> <td>-0.4</td> <td>-0.4</td> <td>-0.4</td> <td>-0.4</td> <td>-0.4</td> <td>-0.4</td> <td>-0.4</td> <td>-0.4</td> <td>-0.4</td> <td>-0.4</td> <td>-0.4</td> <td>-0.4</td> <td>-0.4</td> </tr> <tr> <td>Soil Type D</td> <td>0.0</td> <td>-0.8</td> <td>-0.8</td> <td>-0.8</td> <td>-0.8</td> <td>-0.8</td> <td>-0.4</td> <td>-0.8</td> <td>-0.8</td> <td>-0.4</td> <td>-0.8</td> <td>-0.8</td> <td>-0.8</td> <td>-0.8</td> <td>-0.8</td> </tr> <tr> <td>Soil Type E</td> <td>0.0</td> <td>-0.8</td> <td>-1.2</td> <td>-1.2</td> <td>-1.0</td> <td>-1.2</td> <td>-0.8</td> <td>-1.2</td> <td>-0.8</td> <td>-0.8</td> <td>-0.4</td> <td>-1.2</td> <td>-0.4</td> <td>-0.6</td> <td>-0.8</td> </tr> </table>									BASIC SCORE, MODIFIERS, AND FINAL SCORE, S													BUILDING TYPE	W1	W2	S1	S2	S3	S4	S5	C1	C2	C3	PC1	PC2	RM1	RM2	URM	Basic Score	4.4	3.8	3.0	3.2	2.8	2.3	2.5	2.8	1.8	2.6	2.4	2.8	2.8	2.8	1.8	Mid Rise (4 to 7 stories)	N/A	N/A	+0.2	+0.4	N/A	+0.4	+0.4	+0.4	+0.4	+0.2	N/A	+0.2	+0.4	+0.4	0.0	High Rise (> 7 stories)	N/A	N/A	+0.6	+0.8	N/A	+0.8	+0.8	+0.8	+0.8	+0.3	N/A	+0.4	N/A	+0.6	N/A	Vertical Irregularity	-2.5	-2.0	-1.0	-1.5	N/A	-1.0	-1.0	-1.5	-1.0	-1.0	N/A	-1.0	-1.0	-1.0	-1.0	Plan Irregularity	-0.5	-0.5	-0.5	-0.5	-0.5	-0.5	-0.5	-0.5	-0.5	-0.5	-0.5	-0.5	-0.5	-0.5	-0.5	Pre-Code	0.0	-1.0	-1.0	-0.8	-0.8	-0.8	-0.2	-1.2	-1.0	-0.2	-0.8	-0.8	-1.0	-0.8	-0.2	Post-Benchmark	+2.4	+2.4	+1.4	+1.4	N/A	+1.6	N/A	+1.4	+2.4	N/A	+2.4	N/A	+2.8	+2.6	N/A	Soil Type C	0.0	-0.4	-0.4	-0.4	-0.4	-0.4	-0.4	-0.4	-0.4	-0.4	-0.4	-0.4	-0.4	-0.4	-0.4	Soil Type D	0.0	-0.8	-0.8	-0.8	-0.8	-0.8	-0.4	-0.8	-0.8	-0.4	-0.8	-0.8	-0.8	-0.8	-0.8	Soil Type E	0.0	-0.8	-1.2	-1.2	-1.0	-1.2	-0.8	-1.2	-0.8	-0.8	-0.4	-1.2	-0.4	-0.6	-0.8	
BASIC SCORE, MODIFIERS, AND FINAL SCORE, S																																																																																																																																																																																																						
BUILDING TYPE	W1	W2	S1	S2	S3	S4	S5	C1	C2	C3	PC1	PC2	RM1	RM2	URM																																																																																																																																																																																							
Basic Score	4.4	3.8	3.0	3.2	2.8	2.3	2.5	2.8	1.8	2.6	2.4	2.8	2.8	2.8	1.8																																																																																																																																																																																							
Mid Rise (4 to 7 stories)	N/A	N/A	+0.2	+0.4	N/A	+0.4	+0.4	+0.4	+0.4	+0.2	N/A	+0.2	+0.4	+0.4	0.0																																																																																																																																																																																							
High Rise (> 7 stories)	N/A	N/A	+0.6	+0.8	N/A	+0.8	+0.8	+0.8	+0.8	+0.3	N/A	+0.4	N/A	+0.6	N/A																																																																																																																																																																																							
Vertical Irregularity	-2.5	-2.0	-1.0	-1.5	N/A	-1.0	-1.0	-1.5	-1.0	-1.0	N/A	-1.0	-1.0	-1.0	-1.0																																																																																																																																																																																							
Plan Irregularity	-0.5	-0.5	-0.5	-0.5	-0.5	-0.5	-0.5	-0.5	-0.5	-0.5	-0.5	-0.5	-0.5	-0.5	-0.5																																																																																																																																																																																							
Pre-Code	0.0	-1.0	-1.0	-0.8	-0.8	-0.8	-0.2	-1.2	-1.0	-0.2	-0.8	-0.8	-1.0	-0.8	-0.2																																																																																																																																																																																							
Post-Benchmark	+2.4	+2.4	+1.4	+1.4	N/A	+1.6	N/A	+1.4	+2.4	N/A	+2.4	N/A	+2.8	+2.6	N/A																																																																																																																																																																																							
Soil Type C	0.0	-0.4	-0.4	-0.4	-0.4	-0.4	-0.4	-0.4	-0.4	-0.4	-0.4	-0.4	-0.4	-0.4	-0.4																																																																																																																																																																																							
Soil Type D	0.0	-0.8	-0.8	-0.8	-0.8	-0.8	-0.4	-0.8	-0.8	-0.4	-0.8	-0.8	-0.8	-0.8	-0.8																																																																																																																																																																																							
Soil Type E	0.0	-0.8	-1.2	-1.2	-1.0	-1.2	-0.8	-1.2	-0.8	-0.8	-0.4	-1.2	-0.4	-0.6	-0.8																																																																																																																																																																																							
FINAL SCORE, S COMMENTS									Detailed Evaluation Required YES NO																																																																																																																																																																																													

* Estimated, subjective, or unreliable data
 DNK = Do Not Know
 BR = Braced frame
 FD = Flexible diaphragm
 LM = Light metal
 MRF = Moment-resisting frame
 RC = Reinforced concrete
 RD = Rigid diaphragm
 SW = Shear wall
 TU = Tilt up
 URM = Unreinforced masonry w/d

Figure 3-3 Sample Data Collection Form showing location for sketches of building plan and elevation views.

3.2.4 Total Floor Area

The total floor area, in some cases available from building department or assessor files (see Section 2.6), will most likely be estimated by multiplying the estimated area of one story by the total number of stories in the building. The length and width of the building can be paced off or estimated (during the planning stage) from Sanborn or other parcel maps. Total floor area is useful for estimating occupancy load (see Section 3.5.2) and may be useful at a later time for estimating the value of the building. Indicate with an asterisk when total floor area is estimated.

3.3 Sketching the Plan and Elevation Views

As a minimum, a sketch of the plan of the building should be drawn on the Data Collection Form (see Figure 3-3). An elevation may also be useful in indicating significant features. The sketches are especially important, as they reveal many of the building's attributes to the screener as the sketch is

made. In other words, it forces the screener to systematically view all aspects of the building. The plan sketch should include the location of the building on the site and distance to adjacent buildings. One suggestion is to make the plan sketch from a Sanborn map as part of pre-field work (see Chapter 2), and then verify it in the field. This is especially valuable when access between buildings is not available. If all sides of the building are different, an elevation should be sketched for each side. Otherwise indicate that the sketch is typical of all sides. The sketch should note and emphasize special features such as existing significant cracks or configuration problems.

Dimensions should be included. As indicated in the previous section, the length and width of the building can be paced off or estimated (during the planning stage) from Sanborn or other parcel maps.

3.4 Determining Soil Type

As indicated in Section 2.6.6, soil type should be identified and documented on the Data Collection Form (see Figure 3-4) during the pre-field soils data acquisition and review phase. If soil type has not been determined as part of that process, it needs to be identified by the screener during the

SOIL TYPE					
A	B	C	D	E	F
Hard Rock	Avg. Rock	Dense Soil	Stiff Soil	Soft Soil	Poor Soil

Rapid Visual Screening of Buildings for Potential Seismic Hazards
FEMA-154 Data Collection Form

HIGH Seismicity

	Address: _____ Zip: _____ Other Identifiers _____ No. Stories _____ Year Built _____ Screener _____ Date _____ Total Floor Area (sq. ft.) _____ Building Name _____ Use _____																																																																																																																																																																																																					
PHOTOGRAPH																																																																																																																																																																																																						
Scale: _____																																																																																																																																																																																																						
<table border="1" style="width: 100%; border-collapse: collapse;"> <tr> <th colspan="2">OCCUPANCY</th> <th colspan="2">SOIL</th> <th colspan="2">TYPE</th> <th colspan="2">FALLING HAZARDS</th> </tr> <tr> <td>Assembly</td> <td>Govt.</td> <td rowspan="2">Number of Persons 0-10 11-100 101-1000 1000+</td> <td>A</td> <td>B</td> <td>C</td> <td>D</td> <td>E</td> <td>F</td> </tr> <tr> <td>Commercial</td> <td>Historic</td> <td>Hard Rock</td> <td>Avg. Dense Soil</td> <td>Stiff Soil</td> <td>Soft Soil</td> <td>Floor Soil</td> <td></td> </tr> <tr> <td>Emer. Services</td> <td>Industrial</td> <td>School</td> <td colspan="2"></td> <td colspan="2"></td> <td colspan="2"> <input type="checkbox"/> Unreinforced Chimneys <input type="checkbox"/> Parapets <input type="checkbox"/> Cladding <input type="checkbox"/> Other </td> </tr> </table>									OCCUPANCY		SOIL		TYPE		FALLING HAZARDS		Assembly	Govt.	Number of Persons 0-10 11-100 101-1000 1000+	A	B	C	D	E	F	Commercial	Historic	Hard Rock	Avg. Dense Soil	Stiff Soil	Soft Soil	Floor Soil		Emer. Services	Industrial	School					<input type="checkbox"/> Unreinforced Chimneys <input type="checkbox"/> Parapets <input type="checkbox"/> Cladding <input type="checkbox"/> Other																																																																																																																																																													
OCCUPANCY		SOIL		TYPE		FALLING HAZARDS																																																																																																																																																																																																
Assembly	Govt.	Number of Persons 0-10 11-100 101-1000 1000+	A	B	C	D	E	F																																																																																																																																																																																														
Commercial	Historic		Hard Rock	Avg. Dense Soil	Stiff Soil	Soft Soil	Floor Soil																																																																																																																																																																																															
Emer. Services	Industrial	School					<input type="checkbox"/> Unreinforced Chimneys <input type="checkbox"/> Parapets <input type="checkbox"/> Cladding <input type="checkbox"/> Other																																																																																																																																																																																															
<table border="1" style="width: 100%; border-collapse: collapse; font-size: small;"> <tr> <th colspan="13">BASIC SCORE, MODIFIERS, AND FINAL SCORE, S</th> </tr> <tr> <th>BUILDING TYPE</th> <th>W1</th> <th>W2</th> <th>S1</th> <th>S2</th> <th>S3</th> <th>S4</th> <th>S5</th> <th>C1</th> <th>C2</th> <th>C3</th> <th>PC1</th> <th>PC2</th> <th>RM1</th> <th>RM2</th> <th>URM</th> </tr> <tr> <td>Basic Score</td> <td>4.4</td> <td>3.8</td> <td>3.0</td> <td>3.2</td> <td>2.8</td> <td>2.3</td> <td>2.5</td> <td>2.8</td> <td>1.8</td> <td>2.6</td> <td>2.4</td> <td>2.8</td> <td>2.8</td> <td>2.8</td> <td>1.8</td> </tr> <tr> <td>Mid Rise (4 to 7 stories)</td> <td>N/A</td> <td>N/A</td> <td>+0.2</td> <td>+0.4</td> <td>N/A</td> <td>+0.4</td> <td>+0.4</td> <td>+0.4</td> <td>+0.4</td> <td>+0.2</td> <td>N/A</td> <td>+0.2</td> <td>+0.4</td> <td>+0.4</td> <td>0.0</td> </tr> <tr> <td>High Rise (> 7 stories)</td> <td>N/A</td> <td>N/A</td> <td>+0.6</td> <td>+0.8</td> <td>N/A</td> <td>+0.8</td> <td>+0.8</td> <td>+0.8</td> <td>+0.8</td> <td>+0.3</td> <td>N/A</td> <td>+0.4</td> <td>N/A</td> <td>+0.6</td> <td>N/A</td> </tr> <tr> <td>Vertical Irregularity</td> <td>-2.5</td> <td>-2.0</td> <td>-1.0</td> <td>-1.5</td> <td>N/A</td> <td>-1.0</td> <td>-1.0</td> <td>-1.5</td> <td>-1.0</td> <td>-1.0</td> <td>N/A</td> <td>-1.0</td> <td>-1.0</td> <td>-1.0</td> <td>-1.0</td> </tr> <tr> <td>Plan Irregularity</td> <td>-0.5</td> <td>-0.5</td> <td>-0.5</td> <td>-0.5</td> <td>-0.5</td> <td>-0.5</td> <td>-0.5</td> <td>-0.5</td> <td>-0.5</td> <td>-0.5</td> <td>-0.5</td> <td>-0.5</td> <td>-0.5</td> <td>-0.5</td> <td>-0.5</td> </tr> <tr> <td>Pre-Code</td> <td>0.0</td> <td>-1.0</td> <td>-1.0</td> <td>-0.8</td> <td>-0.8</td> <td>-0.8</td> <td>-0.2</td> <td>-1.2</td> <td>-1.0</td> <td>-0.2</td> <td>-0.8</td> <td>-0.8</td> <td>-1.0</td> <td>-0.8</td> <td>-0.2</td> </tr> <tr> <td>Post-Benchmark</td> <td>+2.4</td> <td>+2.4</td> <td>+1.4</td> <td>+1.4</td> <td>N/A</td> <td>+1.6</td> <td>N/A</td> <td>+1.4</td> <td>+2.4</td> <td>N/A</td> <td>+2.4</td> <td>N/A</td> <td>+2.8</td> <td>+2.6</td> <td>N/A</td> </tr> <tr> <td>Soil Type C</td> <td>0.0</td> <td>-0.4</td> <td>-0.4</td> <td>-0.4</td> <td>-0.4</td> <td>-0.4</td> <td>-0.4</td> <td>-0.4</td> <td>-0.4</td> <td>-0.4</td> <td>-0.4</td> <td>-0.4</td> <td>-0.4</td> <td>-0.4</td> <td>-0.4</td> </tr> <tr> <td>Soil Type D</td> <td>0.0</td> <td>-0.8</td> <td>-0.8</td> <td>-0.8</td> <td>-0.8</td> <td>-0.8</td> <td>-0.4</td> <td>-0.8</td> <td>-0.8</td> <td>-0.4</td> <td>-0.8</td> <td>-0.8</td> <td>-0.8</td> <td>-0.8</td> <td>-0.8</td> </tr> <tr> <td>Soil Type E</td> <td>0.0</td> <td>-0.8</td> <td>-1.2</td> <td>-1.2</td> <td>-1.0</td> <td>-1.2</td> <td>-0.8</td> <td>-1.2</td> <td>-0.8</td> <td>-0.8</td> <td>-0.4</td> <td>-1.2</td> <td>-0.4</td> <td>-0.6</td> <td>-0.8</td> </tr> </table>									BASIC SCORE, MODIFIERS, AND FINAL SCORE, S													BUILDING TYPE	W1	W2	S1	S2	S3	S4	S5	C1	C2	C3	PC1	PC2	RM1	RM2	URM	Basic Score	4.4	3.8	3.0	3.2	2.8	2.3	2.5	2.8	1.8	2.6	2.4	2.8	2.8	2.8	1.8	Mid Rise (4 to 7 stories)	N/A	N/A	+0.2	+0.4	N/A	+0.4	+0.4	+0.4	+0.4	+0.2	N/A	+0.2	+0.4	+0.4	0.0	High Rise (> 7 stories)	N/A	N/A	+0.6	+0.8	N/A	+0.8	+0.8	+0.8	+0.8	+0.3	N/A	+0.4	N/A	+0.6	N/A	Vertical Irregularity	-2.5	-2.0	-1.0	-1.5	N/A	-1.0	-1.0	-1.5	-1.0	-1.0	N/A	-1.0	-1.0	-1.0	-1.0	Plan Irregularity	-0.5	-0.5	-0.5	-0.5	-0.5	-0.5	-0.5	-0.5	-0.5	-0.5	-0.5	-0.5	-0.5	-0.5	-0.5	Pre-Code	0.0	-1.0	-1.0	-0.8	-0.8	-0.8	-0.2	-1.2	-1.0	-0.2	-0.8	-0.8	-1.0	-0.8	-0.2	Post-Benchmark	+2.4	+2.4	+1.4	+1.4	N/A	+1.6	N/A	+1.4	+2.4	N/A	+2.4	N/A	+2.8	+2.6	N/A	Soil Type C	0.0	-0.4	-0.4	-0.4	-0.4	-0.4	-0.4	-0.4	-0.4	-0.4	-0.4	-0.4	-0.4	-0.4	-0.4	Soil Type D	0.0	-0.8	-0.8	-0.8	-0.8	-0.8	-0.4	-0.8	-0.8	-0.4	-0.8	-0.8	-0.8	-0.8	-0.8	Soil Type E	0.0	-0.8	-1.2	-1.2	-1.0	-1.2	-0.8	-1.2	-0.8	-0.8	-0.4	-1.2	-0.4	-0.6	-0.8	
BASIC SCORE, MODIFIERS, AND FINAL SCORE, S																																																																																																																																																																																																						
BUILDING TYPE	W1	W2	S1	S2	S3	S4	S5	C1	C2	C3	PC1	PC2	RM1	RM2	URM																																																																																																																																																																																							
Basic Score	4.4	3.8	3.0	3.2	2.8	2.3	2.5	2.8	1.8	2.6	2.4	2.8	2.8	2.8	1.8																																																																																																																																																																																							
Mid Rise (4 to 7 stories)	N/A	N/A	+0.2	+0.4	N/A	+0.4	+0.4	+0.4	+0.4	+0.2	N/A	+0.2	+0.4	+0.4	0.0																																																																																																																																																																																							
High Rise (> 7 stories)	N/A	N/A	+0.6	+0.8	N/A	+0.8	+0.8	+0.8	+0.8	+0.3	N/A	+0.4	N/A	+0.6	N/A																																																																																																																																																																																							
Vertical Irregularity	-2.5	-2.0	-1.0	-1.5	N/A	-1.0	-1.0	-1.5	-1.0	-1.0	N/A	-1.0	-1.0	-1.0	-1.0																																																																																																																																																																																							
Plan Irregularity	-0.5	-0.5	-0.5	-0.5	-0.5	-0.5	-0.5	-0.5	-0.5	-0.5	-0.5	-0.5	-0.5	-0.5	-0.5																																																																																																																																																																																							
Pre-Code	0.0	-1.0	-1.0	-0.8	-0.8	-0.8	-0.2	-1.2	-1.0	-0.2	-0.8	-0.8	-1.0	-0.8	-0.2																																																																																																																																																																																							
Post-Benchmark	+2.4	+2.4	+1.4	+1.4	N/A	+1.6	N/A	+1.4	+2.4	N/A	+2.4	N/A	+2.8	+2.6	N/A																																																																																																																																																																																							
Soil Type C	0.0	-0.4	-0.4	-0.4	-0.4	-0.4	-0.4	-0.4	-0.4	-0.4	-0.4	-0.4	-0.4	-0.4	-0.4																																																																																																																																																																																							
Soil Type D	0.0	-0.8	-0.8	-0.8	-0.8	-0.8	-0.4	-0.8	-0.8	-0.4	-0.8	-0.8	-0.8	-0.8	-0.8																																																																																																																																																																																							
Soil Type E	0.0	-0.8	-1.2	-1.2	-1.0	-1.2	-0.8	-1.2	-0.8	-0.8	-0.4	-1.2	-0.4	-0.6	-0.8																																																																																																																																																																																							
FINAL SCORE, S COMMENTS									Detailed Evaluation Required YES NO																																																																																																																																																																																													

* Estimated, subjective, or unreliable data
 DNK = Do Not Know
 BR = Braced frame
 FD = Flexible diaphragm
 LM = Light metal
 MRF = Moment-resisting frame
 RC = Reinforced concrete
 RD = Rigid diaphragm
 SW = Shear wall
 TU = Tilt up
 URM = Unreinforced masonry w/d

Figure 3-4 Location on Data Collection Form where soil type information is documented (circled).

building site visit. If there is no basis for classifying the soil type, a soil type E should be assumed. However, for one-story or two-story buildings with a roof height equal to or less than 25 feet, a class D soil type may be assumed when site conditions are not known.

3.5 Determining and Documenting Occupancy

Two sets of information are needed relative to occupancy: (1) building use, and (2) estimated number of persons occupying the building.

3.5.1 Occupancy

Occupancy-related information is indicated by circling the appropriate information in the left-center portion of the form (see Figure 3-5). The occupancy of a building refers to its use, whereas the occupancy load is the number of people in the building (see Section 3.5.2). Although usually not bearing directly on the structural hazard or probability of sustaining major damage, the occupancy of a building is of interest and use when determining priorities for mitigation.

Nine general occupancy classes that are easy to recognize have been defined. They are listed on the form as Assembly, Commercial, Emergency Services (Emer. Services), Government (Govt), Historic, Industrial, Office, Residential, School buildings. These are the same classes used in the first edition of FEMA 154. They have been retained in this edition for consistency, they are easily identifiable from the street, they generally represent the broad spectrum of building uses in the United States, and they are similar to the occupancy categories in the *Uniform Building Code* (ICBO, 1997).

The occupancy class that best describes the building being evaluated should be circled on the form. If there are several types of uses in the building, such as commercial and residential, both should be circled. The actual use of the building may be written in the upper right hand portion of the form. For example, one might indicate that the building is a post office or a library on the line titled “use” in the upper right of the form (see Figure 3-2). In both of these cases, one would also circle “Govt”. If none of the defined classes seem to fit the building, indicate the use in the upper right portion of the form (the building identification area) or include an explanation in the comments section. The nine occupancy classes are described below (with general indications of occupancy load):

OCCUPANCY			
Assembly	Govt	Office	Number of Persons
Commercial	Historic	Residential	0 – 10 11 – 100
Emer. Services	Industrial	School	101-1000 1000+

- **Assembly.** Places of public assembly are those where 300 or more people might be gathered in one room at the same time. Examples are theaters, auditoriums, community centers, performance halls, and churches. (Occupancy load varies greatly and can be as much as 1 person per 10 sq. ft. of floor area, depending primarily on the condition of the seating—fixed versus moveable).
- **Commercial.** The commercial occupancy class refers to retail and wholesale businesses, financial institutions, restaurants, parking structures and light warehouses. (Occupancy load varies; use 1 person per 50 to 200 sq. ft.).
- **Emergency Services.** The emergency services class is defined as any facility that would likely be needed in a major catastrophe. These include police and fire stations, hospitals, and communications centers. (Occupancy load is typically 1 person per 100 sq. ft.).
- **Government.** This class includes local, state and federal non-emergency related buildings (Occupancy load varies; use 1 person per 100 to 200 sq. ft.).
- **Historic.** This class will vary from community to community. It is included because historic buildings may be subjected to specific ordinances and codes.

- **Industrial.** Included in the industrial occupancy class are factories, assembly plants, large warehouses and heavy manufacturing facilities. (Typically, use 1 person per 200 sq. ft. except warehouses, which are perhaps 1 person per 500 sq. ft.).
- **Office.** Typical office buildings house clerical and management occupancies (use 1 person per 100 to 200 sq. ft.).
- **Residential.** This occupancy class refers to residential buildings such as houses, townhouses, dormitories, motels, hotels, apartments and condominiums, and residences for the aged or disabled. (The number of persons for residential occupancies varies from about 1 person per 300 sq. ft. of floor area in dwellings, to perhaps 1 person per 200 sq. ft. in hotels and apartments, to 1 per 100 sq. ft. in dormitories).
- **School.** This occupancy class includes all public and private educational facilities from nursery school to university level. (Occupancy load varies; use 1 person per 50 to 100 sq. ft.).

When occupancy is used by a community as a basis for setting priorities for hazard mitigation purposes, the upgrade of emergency services buildings is often of highest priority. Some communities may have special design criteria governing buildings for emergency services. This information may be used to add a special Score Modifier to increase the score for specially designed emergency buildings.

3.5.2 Occupancy Load

Like the occupancy class or use of the building, the occupancy load may be used by an RVS authority in setting priorities for hazard mitigation plans. The community may wish to upgrade buildings with more occupants first. As can be seen from the form (Figure 3-5), the occupancy load is defined in ranges such as 1-10, 11-100, 101-1000, and 1000+ occupants. The range that best describes the average occupancy of the building is circled. For example, if an office building appears to have a daytime occupancy of 200 persons, and an occupancy of only one or two persons otherwise, the maximum occupancy load is 101-1000 persons. If the occupancy load is estimated from building size and use, an inserted asterisk will automatically indicate that these are approximate data.

3.6 Identifying Potential Nonstructural Falling Hazards

Nonstructural falling hazards such as chimneys, parapets, cornices, veneers, overhangs and heavy cladding can pose life-safety hazards if not adequately anchored to the building. Although these hazards may be present, the basic lateral-load system for the building may be adequate and require no further review. A series of four boxes have been included to indicate the presence of nonstructural falling hazards (see Figure 3-6). The falling hazards of major concern are:

- **Unreinforced Chimneys.** Unreinforced masonry chimneys are common in older masonry and wood-frame dwellings. They are often inadequately tied to the house and fall when strongly shaken. If in doubt as to whether a chimney is reinforced or unreinforced, assume it is unreinforced.
- **Parapets.** Unbraced parapets are difficult to identify from the street as it is sometimes difficult to tell if a facade projects above the roofline. Parapets often exist on three sides of the building, and their height may be visible from the back of the structure.
- **Heavy Cladding.** Large heavy cladding elements, usually precast concrete or cut

FALLING HAZARDS			
<input type="checkbox"/>	<input type="checkbox"/>	<input type="checkbox"/>	<input type="checkbox"/>
Unreinforced Chimneys	Parapets	Heavy Cladding	Other: _____

Rapid Visual Screening of Buildings for Potential Seismic Hazards
FEMA-154 Data Collection Form

HIGH Seismicity

Address: _____
City: _____
Other Identifiers: _____
No. Stories: _____ Year Built: _____
Seismic Zone: _____ Date: _____
Total Floor Area (sq. ft.): _____
Building Name: _____
Use: _____

PHOTOGRAPH

Occupancy	Soil	Type	FALLING HAZARDS			
			Unreinforced Chimneys	Parapets	Heavy Cladding	Other
1-10	1	A	0	0	0	0
11-100	2	B	0	0	0	0
101-1000	3	C	0	0	0	0
1000+	4	D	0	0	0	0

BASIC SCORE, MODIFIERS, AND FINAL SCORE

Score	Occupancy	Soil	Type	Unreinforced Chimneys	Parapets	Heavy Cladding	Other
4.4	1-10	1	A	0	0	0	0
5.4	11-100	2	B	0	0	0	0
6.4	101-1000	3	C	0	0	0	0
7.4	1000+	4	D	0	0	0	0

FINAL SCORE: 6

COMMENTS: _____

Detailed Evaluation Required
YES NO

Figure 3-6 Portion of Data Collection Form for documenting nonstructural falling hazards.

stone, may fall off the building during an earthquake if improperly anchored. The loss of panels may also create major changes to the building stiffness (the elements are considered nonstructural but often contribute substantial stiffness to a building), thus setting up plan irregularities or torsion when only some fall. (Glass curtain walls are not considered as heavy cladding in the RVS procedure.) The existence of heavy cladding is of concern if the connections were designed and installed before the jurisdiction adopted seismic anchorage requirements (normally twice that for gravity loads). The date of such code adoption will vary with jurisdiction and should be established by an experienced design professional in the planning stages of the RVS process (see Section 2.4.2).

If any of the above nonstructural falling hazards exist, the appropriate box should be checked. If there are any other falling hazards, the “Other” box should be checked, and the type of hazard indicated on the line beneath this box. Use the comments section if additional space is required.

The RVS authority may later use this information as a basis for notifying the owner of potential problems.

3.7 Identifying the Lateral-Load-Resisting System and Documenting the Related Basic Structural Score

The RVS procedure is based on the premise that the screener will be able to determine the building’s lateral-load-resisting system from the street, or to eliminate all those that it cannot possibly be. It is further assumed that the lateral-load-resisting system is one of fifteen types that have been observed to be prevalent, based on studies of building stock in the United States. The fifteen types are consistent with the model building types identified in the FEMA 310 Report and the predecessor documents that have addressed seismic evaluation of buildings (e.g., ATC, 1987; BSSC, 1992)). The fifteen model building types used in this document, however, are an abbreviated subset of the 22 types now considered standard by FEMA; excluded from the FEMA 154 list are sub-classifications of certain framing types that specify that the roof and floor diaphragms are either rigid or flexible.

3.7.1 Fifteen Building Types Considered by the RVS Procedure and Related Basic Structural Scores

Following are the fifteen building types used in the RVS procedure. Alpha-numeric reference codes used on the Data Collection Form are shown in parentheses.

1. Light wood-frame residential and commercial buildings smaller than or equal to 5,000 square feet (W1)
2. Light wood-frame buildings larger than 5,000 square feet (W2)
3. Steel moment-resisting frame buildings (S1)
4. Braced steel frame buildings (S2)
5. Light metal buildings (S3)
6. Steel frame buildings with cast-in-place concrete shear walls (S4)
7. Steel frame buildings with unreinforced masonry infill walls (S5)
8. Concrete moment-resisting frame buildings (C1)
9. Concrete shear-wall buildings (C2)
10. Concrete frame buildings with unreinforced masonry infill walls (C3)
11. Tilt-up buildings (PC1)
12. Precast concrete frame buildings (PC2)
13. Reinforced masonry buildings with flexible floor and roof diaphragms (RM1)
14. Reinforced masonry buildings with rigid floor and roof diaphragms (RM2)
15. Unreinforced masonry bearing-wall buildings (URM)

For each of these fifteen model building types, a Basic Structural Hazard Score has been computed that reflects the estimated likelihood that building collapse will occur if the building is subjected to the maximum considered earthquake ground motions for the region. The Basic Structural Hazard Scores are based on the damage and loss estimation functions provided in the FEMA-funded HAZUS damage and loss estimation methodology (NIBS, 1999). For more information about the development of the Basic Structural Hazard Scores, see the companion FEMA 155 report (ATC, 2002).

The Basic Structural Scores are provided on each Data Collection Form in the first row of the

BASIC SCORE, MODIFIERS, AND FINAL SCORE, S															
BUILDING TYPE	W1	W2	S1 (MRF)	S2 (BR)	S3 (LM)	S4 (RC SW)	S5 (URM INF)	C1 (MRF)	C2 (SW)	C3 (URM INF)	PC1 (TU)	PC2	RM1 (FD)	RM2 (RD)	URM
Basic Score	4.4	3.8	2.8	3.0	3.2	2.8	2.0	2.5	2.8	1.6	2.6	2.4	2.8	2.8	1.8

Figure 3-7. Portion of Data Collection Form containing Basic Structural Hazard Scores.

structural scoring matrix in the lower portion of the Data Collection Form (see Figure 3-7). In high and moderate seismicity regions, these scores apply to buildings built after the initial adoption and enforcement of seismic codes, but before the relatively recent significant improvement of codes (that is, before the applicable benchmark year, as defined in Table 2-2). In low seismicity regions, they apply to all buildings except those designed and constructed after the applicable benchmark year, as defined in Table 2-2.

A key issue to be addressed in the planning stage (as recommended in Section 2.4.2) is the identification of those years in which seismic codes were initially adopted and later significantly improved. If the RVS authority in high and moderate seismicity regions is unsure of the year(s) in which codes were initially adopted, the default year for all but PC1 (tiltup) buildings is 1941, (the default year specified in the HAZUS criteria, NIBS, 1999). For PC1 (tiltup) buildings, the initial year in which effective seismic codes were specified is 1973 (ICBO, 1973). As described in Sections 3.8.5 and 3.8.6, the Data Collection Form includes Score Modifiers that provide a means for modifying the Basic Structural Hazard Score as a function of design and construction date.

Brief summaries of the physical characteristics and expected earthquake performance of each of

the fifteen model building types, along with a photograph of a sample exterior view, and the Basic Structural Scores for regions of low (L), moderate (M), and high (H) seismicity are provided in Table 3-1.

Additional background information on the physical characteristics and earthquake performance of these building types, not essential to the RVS procedure, is provided in Appendix E.

3.7.2 Identifying the Lateral-Force-Resisting System

At the heart of the RVS procedure is the task of identifying the lateral-force-resisting system from the street. Once the lateral-force-resisting system is identified, the screener finds the appropriate alpha-numeric code on the Data Collection Form and circles the Basic Structural Hazard Score immediately beneath it (see Figure 3-7).

Ideally, the lateral-force-resisting system for each building to be screened would be identified prior to field work through the review and interpretation of construction documents for each building (i.e., during the planning stage, as discussed in Section 2.7).

If prior determination of the lateral-force-resisting system is not possible through the review of building plans, which is the most likely scenario, this determination must be made in the field. In this case, the screener reviews spacing and size of windows, and the apparent construction materials to determine the lateral-force resisting system. If the screener cannot identify with complete assuredness the lateral-force-resisting system from the street, the screener should enter the building interior to verify the building type selected (see Section 3.7.3 for additional information on this issue.)

If the screener cannot determine the lateral-force-resisting system, and access to the interior is not possible, the screener should eliminate those lateral-force-resisting systems that are not possible and assume that any of the others are possible. In this case the Basic Structural Hazard Scores for all possible lateral-force-resisting systems would be circled on the Data Collection Form. More guidance and options pertaining to this issue are provided in Section 3.9.

Table 3-1 Build Type Descriptions, Basic Structural Hazard Scores, and Performance in Past Earthquakes



<i>Building Identifier</i>	<i>Photograph</i>	<i>Basic Structural Hazard Score</i>	<i>Characteristics and Performance</i>
<p>W1 Light wood frame residential and commercial buildings equal to or smaller than 5,000 square feet</p>		<p>H = 2.8 M = 5.2 L = 7.4</p>	<ul style="list-style-type: none"> • Wood stud walls are typically constructed of 2-inch by 4-inch vertical wood members set about 16 inches apart (2-inch by 6-inch for multiple stories). • Most common exterior finish materials are wood siding, metal siding, or stucco. • Buildings of this type performed very well in past earthquakes due to inherent qualities of the structural system and because they are lightweight and low rise. • Earthquake-induced cracks in the plaster and stucco (if any) may appear, but are classified as non-structural damage. • The most common type of structural damage in older buildings results from a lack of connection between the superstructure and the foundation, and inadequate chimney support. • These are large apartment buildings, commercial buildings or industrial structures usually of one to three stories, and, rarely, as tall as six stories.
<p>W2 Light wood frame buildings greater than 5,000 square feet</p>		<p>H = 3.8 M = 4.8 L = 6.0</p>	

Table 3-1 Build Type Descriptions, Basic Structural Hazard Scores, and Performance in Past Earthquakes (Continued)



<i>Building Identifier</i>	<i>Photograph</i>	<i>Basic Structural Hazard Score</i>	<i>Characteristics and Performance</i>
<p>S1 Steel moment-resisting frame</p>		<p>H = 2.8 M = 3.6 L = 4.6</p>	<ul style="list-style-type: none"> • Typical steel moment-resisting frame structures usually have similar bay widths in both the transverse and longitudinal directions, around 20-30 ft. • The floor diaphragms are usually concrete, sometimes over steel decking. This structural type is used for commercial, institutional and public buildings. • The 1994 Northridge and 1995 Kobe earthquakes showed that the welds in steel moment-frame buildings were vulnerable to severe damage. The damage took the form of broken connections between the beams and columns. • These buildings are braced with diagonal members, which usually cannot be detected from the building exterior.
<p>S2 Braced steel frame</p>		<p>H = 3.0 M = 3.6 L = 4.8</p>	<ul style="list-style-type: none"> • Braced frames are sometimes used for long and narrow buildings because of their stiffness. • From the building exterior, it is difficult to tell the difference between steel moment frames, steel braced frames, and steel frames with interior concrete shear walls. • In recent earthquakes, braced frames were found to have damage to brace connections, especially at the lower levels.
			
	<p>Zoom-in of upper photo</p>		

Table 3-1 Build Type Descriptions, Basic Structural Hazard Scores, and Performance in Past Earthquakes (Continued)



<i>Building Identifier</i>	<i>Photograph</i>	<i>Basic Structural Hazard Score</i>	<i>Characteristics and Performance</i>
<p>S3 Light metal building</p>		<p>H = 3.2 M = 3.8 L = 4.6</p>	<ul style="list-style-type: none"> ● The structural system usually consists of moment frames in the transverse direction and braced frames in the longitudinal direction, with corrugated sheet-metal siding. In some regions, light metal buildings may have partial-height masonry walls. ● The interiors of most of these buildings do not have interior finishes and their structural skeleton can be seen easily. ● Insufficient capacity of tension braces can lead to their elongation and consequent building damage during earthquakes. ● Inadequate connection to a slab foundation can allow the building columns to slide on the slab. ● Loss of the cladding can occur.
<p>S4 Steel frames with cast-in-place concrete shear walls</p>		<p>H = 2.8 M = 3.6 L = 4.8</p>	<ul style="list-style-type: none"> ● Lateral loads are resisted by shear walls, which usually surround elevator cores and stairwells, and are covered by finish materials. ● An interior investigation will permit a wall thickness check. More than six inches in thickness usually indicates a concrete wall. ● Shear cracking and distress can occur around openings in concrete shear walls during earthquakes. ● Wall construction joints can be weak planes, resulting in wall shear failure below expected capacity.

Table 3-1 Build Type Descriptions, Basic Structural Hazard Scores, and Performance in Past Earthquakes (Continued)



<i>Building Identifier</i>	<i>Photograph</i>	<i>Basic Structural Hazard Score</i>	<i>Characteristics and Performance</i>
<p>S5 Steel frames with unreinforced masonry infill walls</p>		<p>H = 2.0 M = 3.6 L = 5.0</p>	<ul style="list-style-type: none"> • Steel columns are relatively thin and may be hidden in walls. • Usually masonry is exposed on exterior with narrow piers (less than 4 ft wide) between windows. • Portions of solid walls will align vertically. • Infill walls are usually two to three wythes thick. • Veneer masonry around columns or beams is usually poorly anchored and detaches easily.
<p>C1 Concrete moment-resisting frames</p>		<p>H = 2.5 M = 3.0 L = 4.4</p>	<ul style="list-style-type: none"> • All exposed concrete frames are reinforced concrete (not steel frames encased in concrete). • A fundamental factor governing the performance of concrete moment-resisting frames is the level of ductile detailing. • Large spacing of ties in columns can lead to a lack of concrete confinement and shear failure. • Lack of continuous beam reinforcement can result in hinge formation during load reversal. • The relatively low stiffness of the frame can lead to substantial nonstructural damage. • Column damage due to pounding with adjacent buildings can occur.

Table 3-1 Build Type Descriptions, Basic Structural Hazard Scores, and Performance in Past Earthquakes (Continued)



<i>Building Identifier</i>	<i>Photograph</i>	<i>Basic Structural Hazard Score</i>	<i>Characteristics and Performance</i>
<p>C2 Concrete shear wall buildings</p>		<p>H = 2.8 M = 3.6 L = 4.8</p>	<ul style="list-style-type: none"> ● Concrete shear-wall buildings are usually cast in place, and show typical signs of cast-in-place concrete. ● Shear-wall thickness ranges from 6 to 10 inches. ● These buildings generally perform better than concrete frame buildings. ● They are heavier than steel-frame buildings but more rigid due to the shear walls. ● Damage commonly observed in taller buildings is caused by vertical discontinuities, pounding, and irregular configuration.
<p>C3 Concrete frames with unreinforced masonry infill walls</p>		<p>H = 1.6 M = 3.2 L = 4.4</p>	<ul style="list-style-type: none"> ● Concrete columns and beams may be full wall thickness and may be exposed for viewing on the sides and rear of the building. ● Usually masonry is exposed on the exterior with narrow piers (less than 4 ft wide) between windows. ● Portions of solid walls will align vertically. ● This type of construction was generally built before 1940 in high-seismicity regions but continues to be built in other regions. ● Infill walls tend to buckle and fall out-of-plane when subjected to strong lateral out-of-plane forces. ● Veneer masonry around columns or beams is usually poorly anchored and detaches easily.

Table 3-1 Build Type Descriptions, Basic Structural Hazard Scores, and Performance in Past Earthquakes (Continued)

<i>Building Identifier</i>	<i>Photograph</i>	<i>Basic Structural Hazard Score</i>	<i>Characteristics and Performance</i>
<p>PC1 Tilt-up buildings</p>	 <p data-bbox="397 1060 812 1121">Partial roof collapse due to failed diaphragm-to-wall connection</p>	<p>H = 2.6 M = 3.2 L = 4.4</p>	<ul style="list-style-type: none"> ● Tilt-ups are typically one or two stories high and are basically rectangular in plan. ● Exterior walls were traditionally formed and cast on the ground adjacent to their final position, and then “tilted-up” and attached to the floor slab. ● The roof can be a plywood diaphragm carried on wood purlins and glulam beams or a light steel deck and joist system, supported in the interior of the building on steel pipe columns. ● Weak diaphragm-to-wall anchorage results in the wall panels falling and the collapse of the supported diaphragm (or roof).

Table 3-1 Build Type Descriptions, Basic Structural Hazard Scores, and Performance in Past Earthquakes (Continued)







<i>Building Identifier</i>	<i>Photograph</i>	<i>Basic Structural Hazard Score</i>	<i>Characteristics and Performance</i>
<p>PC2 Precast concrete frame buildings</p>	 <p data-bbox="349 646 657 676">Building under construction</p>	<p>H = 2.4 M = 3.2 L = 4.6</p>	<ul style="list-style-type: none"> ● Precast concrete frames are, in essence, post and beam construction in concrete. ● Structures often employ concrete or reinforced masonry (brick or block) shear walls. ● The performance varies widely and is sometimes poor. ● They experience the same types of damage as shear wall buildings (C2). ● Poorly designed connections between prefabricated elements can fail. ● Loss of vertical support can occur due to inadequate bearing area and insufficient connection between floor elements and columns. ● Corrosion of metal connectors between prefabricated elements can occur.
	 <p data-bbox="349 1234 716 1264">Detail of the precast components</p>		
	 <p data-bbox="349 1612 662 1642">Building nearing completion</p>		



Table 3-1 Build Type Descriptions, Basic Structural Hazard Scores, and Performance in Past Earthquakes (Continued)

<i>Building Identifier</i>	<i>Photograph</i>	<i>Basic Structural Hazard Score</i>	<i>Characteristics and Performance</i>
<p>RM1 Reinforced masonry buildings with flexible diaphragms</p>		<p>H = 2.8 M = 3.6 L = 4.8</p>	<ul style="list-style-type: none"> ● Walls are either brick or concrete block. ● Wall thickness is usually 8 inches to 12 inches. ● Interior inspection is required to determine if diaphragms are flexible or rigid. ● The most common floor and roof systems are wood, light steel, or precast concrete. ● These buildings can perform well in moderate earthquakes if they are adequately reinforced and grouted, with sufficient diaphragm anchorage. ● Poor construction practice can result in ungrouted and unreinforced walls, which will fail easily.
			
			

Truss-joists support plywood and light-weight concrete slab

Detail showing reinforced masonry

Table 3-1 Build Type Descriptions, Basic Structural Hazard Scores, and Performance in Past Earthquakes (Continued)

<i>Building Identifier</i>	<i>Photograph</i>	<i>Basic Structural Hazard Score</i>	<i>Characteristics and Performance</i>
<p>RM2 Reinforced masonry buildings with rigid diaphragms</p>		<p>H = 2.8 M = 3.4 L = 4.6</p>	<ul style="list-style-type: none"> ● Walls are either brick or concrete block. ● Wall thickness is usually 8 inches to 12 inches. ● Interior inspection is required to determine if diaphragms are flexible or rigid. ● The most common floor and roof systems are wood, light steel, or precast concrete. ● These buildings can perform well in moderate earthquakes if they are adequately reinforced and grouted, with sufficient diaphragm anchorage. ● Poor construction practice can result in ungrouted and unreinforced walls, which will fail easily.
<p>URM Unreinforced masonry buildings</p>		<p>H = 1.8 M = 3.4 L = 4.6</p>	<ul style="list-style-type: none"> ● These buildings often used weak lime mortar to bond the masonry units together. ● Arches are often an architectural characteristic of older brick bearing wall buildings. ● Other methods of spanning are also used, including steel and stone lintels. ● Unreinforced masonry usually shows header bricks in the wall surface. ● The performance of this type of construction is poor due to lack of anchorage of walls to floors and roof, soft mortar, and narrow piers between window openings.

Determining the lateral-force-resisting system in the field is often difficult. A useful first step is to determine if the building structure is a frame or a bearing wall. Examples of frame structures and bearing wall structures are shown in Figure 3-8, 3-9, and 3-10.

Information to assist the screener in distinguishing if the building is a bearing wall or frame structure is provided in the side bar. Once this determination has been made and the

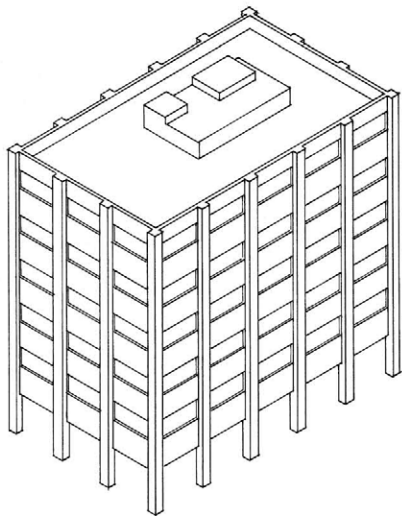

Figure 3-8 Typical frame structure. Features include: large window spans, window openings on many sides, and clearly visible column-beam grid pattern.

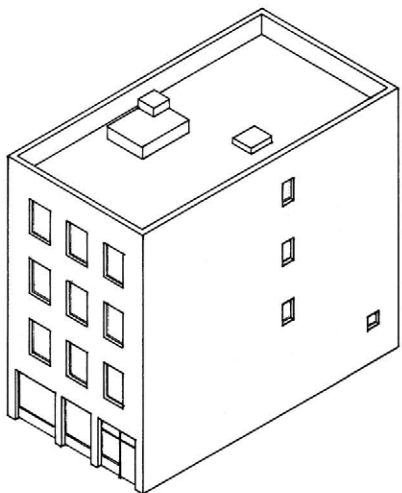

Figure 3-9 Typical bearing wall structure. Features include small window span, at least two mostly solid walls, and thick load-bearing walls.

Distinguishing Between Frame and Bearing Wall Building Systems.

A frame structure (for example, S1, S2, S3, S4, C1, PC2) is made up of beams and columns throughout the entire structure, resisting both vertical and lateral loads. A bearing wall structure (for example, PC1 and URM) uses vertical-load-bearing walls, which are more or less solid, to resist the vertical and lateral loads.

When a building has large openings on all sides, it is probably a frame structure as opposed to a bearing wall structure. A common characteristic of a frame structure is the rectangular grid patterns of the facade, indicating the location of the columns and girders behind the finish material. This is particularly revealing when windows occupy the entire opening in the frame, and no infill wall is used. A newer multistory commercial building should be assumed to be a frame structure, even though there may exist interior shear walls carrying the lateral loads (this would be a frame structure with shear walls).

Bearing wall systems carry vertical and lateral loads with walls rather than solely with columns. Structural floor members such as slabs, joists, and beams, are supported by load-bearing walls. A bearing wall system is thus characterized by more or less solid walls and, as a rule of thumb, a load-bearing wall will have more solid areas than openings. It also will have no wide openings, unless a structural lintel is used.

Some bearing-wall structures incorporate structural columns, or are partly frame structures. This is especially popular in multistory commercial buildings in urban lots where girders and columns are used in the ground floor of a bearing wall structure to provide larger openings for retail spaces. Another example is where the loads are carried by both interior columns and a perimeter wall. Both of these examples should be considered as bearing wall structures, because lateral loads are resisted by the bearing walls. Bearing wall structures sometimes utilize only two walls for load bearing. The other walls are non-load-bearing and thus may have large openings. Therefore, the openness of the front elevation should not be used to determine the structure type. The screener should also look at the side and rear facades. If at least two of the four exterior walls appear to be solid then it is likely that it is a bearing wall structure.

Window openings in older frame structures can sometimes be misleading. Since wide windows were excessively costly and fragile until relatively recently, several narrow windows separated by thin mullions are often seen in older buildings. These thin mullions are usually not load bearing. When the narrow windows are close together, they constitute a large opening typical of a frame structure, or a window in a bearing wall structure with steel lintels.

Whereas open facades on all sides clearly indicate a frame structure, solid walls may be indicative of a bearing wall structure or a frame structure with solid infill walls. Bearing walls are usually much thicker than infill walls, and increase in thickness in the lower stories of multi-story buildings. This increase in wall thickness can be detected by comparing the wall thickness at windows on different floors. Thus, solid walls can be identified as bearing or non-bearing walls according to their thickness, if the structural material is known.

A bearing wall system is sometimes called a box system.



Example of a Frame Building



Example of a Bearing Wall Structure

Figure 3-10 Frame and bearing wall structures

principal structural material is identified, the essential information for determining the lateral-force-resisting system has been established. It is then useful to know that:

- unreinforced masonry and tilt-up buildings are usually bearing-wall type,
- steel buildings and pre-cast concrete buildings are usually frame type, and
- concrete and reinforced masonry buildings may be either type.

A careful review of Table 3-1 and the information provided in Appendices D and E, along with training by knowledgeable building design professionals, should assist the screener in the determination of lateral-force-resisting systems. There will be some buildings for which the lateral-force-resisting system cannot be identified because of their facade treatment. In this case, the screener should eliminate those

lateral-force-resisting systems that are not possible and assume that any of the others are possible.

3.7.3 Interior Inspections

Ideally, whenever possible, the screener should seek access to the interior of the building to identify, or verify, the lateral-force-resisting system for the building. In the case of reinforced masonry buildings, entry is particularly important so that the screener can distinguish between RM1 buildings, which have flexible floor and roof diaphragms, and RM2 buildings, which have rigid floor and roof diaphragms.

As with the exterior inspection, the interior process should be performed in a logical manner, either from the basement to the roof, or roof to basement. The screener should look at each floor thoroughly.

The RVS procedure does not require the removal of finish materials that are otherwise permanently affixed to the structure. There are a number of places within a building where it is possible to see the exposed structure. The following are some ways to determine the structure type.

1. If the building has a basement that is not occupied, the first-floor framing may be exposed. The framing will usually be representative of the floor framing throughout the building.
2. If the structural system is a steel or concrete frame, the columns and beams will often be exposed in the basement. The basement walls will likely be concrete, but this does not mean that they are concrete all the way to the roof.
3. High and mid-rise structures usually have one or more levels of parking below the building. When fireproofed steel columns and girders are seen, the screener can be fairly certain that the structure is a steel building (S1, S2, or S4 see Figure 3-11).
4. If the columns and beams are constructed of concrete, the structure type is most likely a concrete moment-frame building (C1, see Figure 3-12). However, this is not guaranteed as some buildings will use steel framing above the ground floor. To ascertain the building type, the screener will need to look at the columns above the first floor.
5. If there is no basement, the mechanical equipment rooms may show what the framing is for the floor above.



Figure 3-11 Interior view showing fire-proofed columns and beams, which indicate a steel building (S1, S2, or S4).

6. If suspended ceilings are used, one of the ceiling tiles can be lifted and simply pushed back. In many cases, the floor framing will then be exposed. Caution should be used in identifying the framing materials, because prior to about 1960, steel beams were encased in concrete to provide fireproofing. If steel framing is seen with what appears to be concrete beams, most likely these are steel beams encased in concrete.
7. If plastered ceilings are observed above suspended ceilings, the screener will not be able to identify the framing materials;

however, post-1960 buildings can be eliminated as a possibility because these buildings do not use plaster for ceilings.

8. At the exterior walls, if the structural system is a frame system, there will be regularly spaced furred out places. These are the building columns. If the exterior walls between the columns are constructed of brick masonry and the thickness of the wall is 9 inches or more, the structure type is either steel frame with unreinforced masonry infill (S5) or concrete frame with unreinforced masonry infill (C3).
9. Pre-1930 brick masonry buildings that are six stories or less in height and that have wood-floor framing supported on masonry ledges in pockets formed in the wall are unreinforced masonry bearing-wall buildings (URM).

3.7.4 Screening Buildings with More Than One Lateral-Force-Resisting System

In some cases, the screener may observe buildings having more than one lateral-force-resisting system. Examples might include a wood-frame building atop a precast concrete parking garage, or a building with reinforced concrete shear walls in one direction and a reinforced moment-resisting frame in the other.

Buildings that incorporate more than one lateral-force-resisting system should be evaluated for all observed types of structural systems, and the lowest Final Structural Score, *S*, should govern.



Figure 3-12 Interior view showing concrete columns and girders, which indicate a concrete moment frame (C1).

BASIC SCORE, MODIFIERS, AND FINAL SCORE, S																
BUILDING TYPE	W1	W2	S1 (MRF)	S2 (BR)	S3 (LM)	S4 (RC SW)	S5 (URM INF)	C1 (MRF)	C2 (SW)	C3 (URM INF)	PC1 (TU)	PC2	RM1 (FD)	RM2 (RD)	URM	
Basic Score	4.4	3.8	2.8	3.0	3.2	2.8	2.0	2.5	2.8	1.6	2.6	2.4	2.8	2.8	1.8	
Mid Rise (4 to 7 stories)	N/A	N/A	+0.2	+0.4	N/A	+0.4	+0.4	+0.4	+0.4	+0.2	N/A	+0.2	+0.4	+0.4	0.0	
High Rise (> 7 stories)	N/A	N/A	+0.6	+0.8	N/A	+0.8	+0.8	+0.6	+0.8	+0.3	N/A	+0.4	N/A	+0.6	N/A	
Vertical Irregularity	-2.5	-2.0	-1.0	-1.5	N/A	-1.0	-1.0	-1.5	-1.0	-1.0	N/A	-1.0	-1.0	-1.0	-1.0	
Plan irregularity	-0.5	-0.5	-0.5	-0.5	-0.5	-0.5	-0.5	-0.5	-0.5	-0.5	-0.5	-0.5	-0.5	-0.5	-0.5	
Pre-Code	0.0	-1.0	-1.0	-0.8	-0.6	-0.8	-0.2	-1.2	-1.0	-0.2	-0.8	-0.8	-1.0	-0.8	-0.2	
Post-Benchmark	+2.4	+2.4	+1.4	+1.4	N/A	+1.6	N/A	+1.4	+2.4	N/A	+2.4	N/A	+2.8	+2.6	N/A	
Soil Type C	0.0	-0.4	-0.4	-0.4	-0.4	-0.4	-0.4	-0.4	-0.4	-0.4	-0.4	-0.4	-0.4	-0.4	-0.4	
Soil Type D	0.0	-0.8	-0.6	-0.6	-0.6	-0.6	-0.4	-0.6	-0.6	-0.4	-0.6	-0.6	-0.6	-0.6	-0.6	
Soil Type E	0.0	-0.8	-1.2	-1.2	-1.0	-1.2	-0.8	-1.2	-0.8	-0.8	-0.4	-1.2	-0.4	-0.6	-0.8	

Figure 3-13. Portion of Data Collection Form containing attributes that modify performance and associated score modifiers.

3.8 Identifying Seismic Performance Attributes and Recording Score Modifiers

This section discusses major factors that significantly impact structural performance during earthquakes, and the assignment of Score Modifiers related to each of these factors (attributes). The severity of the impact on structural performance varies with the type of lateral-force-resisting system; thus the assigned Score Modifiers depend on building type. Score Modifiers associated with each performance attribute are indicated in the scoring matrix on the Data Collection Form (see Figure 3-13). Score Modifiers for the building being screened are

circled in the appropriate column (i.e., under the reference code for the identified lateral-force-resisting system for that building).

Following are descriptions of each performance attribute, along with guidance on how to recognize each from the street. If a performance attribute does not apply to a given building type, the Score Modifier is indicated with “N/A”, which indicates “not applicable.”

3.8.1 Mid-Rise Buildings

If the building has 4 to 7 stories, it is considered a mid-rise building, and the score modifier associated with this attribute should be circled.

3.8.2 High-Rise Buildings

If the building has 8 or more stories, it is considered a high-rise building, and the score modifier associated with this attribute should be circled.

3.8.3 Vertical Irregularity

This performance attribute applies to all building types. Examples of vertical irregularity include buildings with setbacks, hillside buildings, and buildings with soft stories (see illustrations of example vertical irregularities in Figure 3-14).

If the building is irregularly shaped in elevation, or if some walls are not vertical, then apply the modifier (see example in Figure 3-15).

If the building is on a steep hill so that over the up-slope dimension of the building the hill rises at least one story height, a problem may exist because the horizontal stiffness along the lower side may be different from the uphill side. In addition, in the up-slope direction, the stiff short columns attract the seismic shear forces and may fail. In this case the performance modifier is applicable. See Figure 3-14 for an example.

Setbacks

Hillside

Soft Story

Figure 3-14 Elevation views showing vertical irregularities, with arrows indicating locations of particular concern.

A soft story exists if the stiffness of one story is dramatically less than that of most of the others (see Figure 3-15). Examples are shear walls or infill walls not continuous to the foundation. Soft stories are difficult to verify without knowledge of how the building was designed and how the lateral forces are to be transferred from story to story. In other words, there may be shear walls in the building that are not visible from the street. However, if there is doubt, it is best to be conservative and indicate the existence of a soft story by circling the vertical irregularity Score Modifier. Use an asterisk and the comment section to explain the source of uncertainty. In many commercial buildings, the first story is soft due to large window openings for display

purposes. If one story is particularly tall or has windows on all sides, and if the stories above have fewer windows, then it is probably a soft story.

A building may be adequate in one direction but be “soft” in the perpendicular direction. For example, the front and back walls may be open but the side walls may be solid. Another common example of soft story is “tuck under” parking commonly found in apartment buildings (see Figure 3-16). Several past earthquakes in California have shown the vulnerability of this type of construction.

Vertical irregularity is a difficult characteristic to define, and considerable judgment and experience are required for identification purposes.



Figure 3-15 Example of setbacks (see Figure 3-14) and a soft first story.



Figure 3-16 Example of soft story conditions, where parking requirements result in large weak openings.

3.8.4 Plan Irregularity

If a building has a vertical or plan irregularity, as described below, this modifier applies. Plan irregularity can affect all building types. Examples of plan irregularity include buildings with re-entrant corners, where damage is likely to occur; buildings with good lateral-load resistance in one direction but not in the other; and buildings with major stiffness eccentricities in the lateral-force-resisting system, which may cause twisting (torsion) around a vertical axis.

Buildings with re-entrant corners include those with long wings that are E, L, T, U, or + shaped (see Figures 3-17 and 3-18). See SEAOC (1996) for further discussion of this issue.)

Plan irregularities causing torsion are especially prevalent among corner buildings, in which the two adjacent street sides of the building are largely windowed and open, whereas the other two sides are generally solid. Wedge-shaped buildings, triangular in plan, on corners of streets not meeting at 90°, are similarly susceptible (see Figure 3-19).

Although plan irregularity can occur in all building types, primary concern lies with wood, tilt-up, pre-cast frame, reinforced masonry and unreinforced masonry construction. Damage at connections may significantly reduce the capacity of a vertical-load-carrying element, leading to partial or total collapse.

3.8.5 Pre-Code

This Score Modifier applies for buildings in high and moderate seismicity regions and is applicable if the building being screened was designed and constructed prior to the initial adoption and enforcement of seismic codes applicable for that building type (e.g., steel moment frame, S1). The year(s) in which seismic codes were initially adopted and enforced for the various model building types should have been identified as part

L-Shaped

T-Shaped

U-Shaped

Large Opening

Weak Link Between Larger Building Plan Areas

Figure 3-17 Plan views of various building configurations showing plan irregularities; arrows indicate possible areas of damage.



Figure 3-18 Example of a building, with a plan irregularity, with two wings meeting at right angles.

of the Data Collection Form review process during the pre-planning stage (as recommended in Section 2.4.2). If this determination was not made during the planning stage, the default year is 1941, for all building types except PC1, in which case it is 1973. Because of the method used to calculate the Basic Structural Hazard Scores, this modifier does not apply to buildings in the low seismicity region.

3.8.6 Post-Benchmark

This Score Modifier is applicable if the building being screened was designed and constructed after significantly improved seismic codes applicable for that building type (e.g., concrete moment frame, C1) were adopted and enforced by the local jurisdiction. The year in which such improvements were adopted is termed the “benchmark” year. Benchmark year(s) for the various model building types should have been identified as part of the Data Collection Form review process during the pre-planning stage (as recommended in Section 2.4.2). Benchmark years for the various building types (designed in accordance with various model codes) are provided in Table 2-2.

3.8.7 Soil Type C, D, or E

Score Modifiers are provided for Soil Type C, Type D, and Type E. The appropriate modifier should be circled if one of these soil types exists at the site (see Section 3.4 for additional discussion regarding the determination of soil type). If sufficient guidance or data are not available during the planning stage to classify the soil type as A



Figure 3-19 Example of a building, triangular in plan, subject to torsion.

through E, a soil type E should be assumed. However, for one- or two-story buildings with a roof height equal to or less than 25 feet, a class D soil type may be assumed if the actual site conditions are not known.

There is no Score Modifier for Type F soil because buildings on soil type F cannot be screened effectively by the RVS procedure. A geotechnical engineer is required to confirm the soil type F and an experienced professional engineer is required for building evaluation.

3.9 Determining the Final Score

The Final Structural Score, S , is determined for a given building by adding (or subtracting) the Score Modifiers for that building to the Basic Structural Hazard Score for the building. The result is documented in the section of the form entitled Final Score (see Figure 3-20). Based on this information, and the “cut-off” score selected during the pre-planning process (see Section 2.4.3), the screener then decides if a detailed evaluation is required for the building and circles “YES” or “NO” in the lower right-hand box (see Figure 3-20). Additional guidance on this issue is provided in Sections 4.1, and 4.2.

When the screener is uncertain of the building type, an attempt should be made to eliminate all unlikely building types. If the screener is still left with several choices, computation of the Final Structural Score S may be treated several ways:

1. The screener may calculate S for all the remaining options and choose the lowest

FINAL SCORE	
COMMENTS	Detailed Evaluation Required
	YES NO

Figure 3-20 Location on Data Collection Form where the final score, comments, and an indication if the building needs detailed evaluation are documented.

score. This is a conservative approach, and has the disadvantage that it may be too conservative and the assigned score may indicate that the building presents a greater risk than it actually does. This conservative approach will not pose problems in cases where all the possible remaining building types result in scores below the cut-off value. In all these cases the building has characteristics that justify further review anyway by a design professional experienced in seismic design.

- If the screener has little or no confidence about any choice for the structural system, the screener should write DNK below the word “Building Type” (see Figure 3-7), which indicates the screener does not know. In this case there should be an automatic default to the need for a detailed review of the building by an experienced design professional. A more

detailed field inspection would include entering the building, and examining the basement, roof, and all structural elements.

Which of these two options the RVS authority wishes to adopt should be decided in the RVS planning phase (see Section 2.3).

3.10 Photographing the Building

At least one photograph of the building should be taken for identification purposes. The screener is not limited to one photograph. A photograph contains much more information, although perhaps less emphasized, than the elevation sketch. Large buildings are difficult to photograph from the street and the camera lens introduces distortion for high-rise buildings. If possible, the photograph should be taken from a sufficient distance to include the whole building, and such that adjacent faces are included. A wide angle or a zoom lens may be helpful. Strong sunlit facades should be avoided, as harsh contrasts between shadows and sunlit portions of the facade will be introduced. Lastly, if possible, the front of the building should not be obscured by trees, vehicles or other objects, as they obscure the lower (and often the most important) stories.

3.11 Comments Section

This last section of the form (see Figure 3-20) is for recording any comments the screener may wish to make regarding the building, occupancy, condition, quality of the data or unusual circumstances of any type. For example, if not all significant details can be effectively photographed or drawn, the screener could describe additional important information in the comments area. Comments may be made on the strength of mortar used in a masonry wall, or building features that can be seen at or through window openings. Other examples where comments are helpful are described throughout Chapter 3.

Using the RVS Procedure Results

The rapid visual screening procedure presented in this *Handbook* is meant to be the preliminary screening phase of a multi-phase procedure for identifying earthquake-hazardous buildings. Buildings identified by this procedure as potentially hazardous must be analyzed in more detail by an experienced seismic design professional. Because rapid visual screening is designed to be performed from the street, with interior inspection not always possible, hazardous details will not always be visible, and seismically hazardous buildings may not be identified as such. Conversely, buildings identified as potentially hazardous may prove to be adequate.

Since the original publication of FEMA 154 in 1988, the RVS procedure has been widely used by local communities and government agencies. A critical issue in the implementation of FEMA 154 has been the interpretation of the Final Structural Score, S , and the selection of a “cut-off” score, below which a detailed seismic evaluation of the building by a design professional in seismic design is required.

Following are discussions on: (1) interpretation and selection of the “cut-off” score; (2) prior uses of the FEMA 154 RVS procedure, including decisions regarding the “cut-off” score; and (3) other possible uses of the FEMA 154 RVS procedure, including resources needed for the various possible uses. These discussions are intended to illuminate both the limitations and potential applications of the RVS procedure.

4.1 Interpretation of RVS Score

Having employed the RVS procedure and determined the building’s Final Structural Score, S , which is based on the Basic Structural Hazard Score and Score Modifiers associated with the various performance attributes, the RVS authority is naturally faced with the question of what these S scores mean. Fundamentally, the final S score is an estimate of the probability (or chance) that the building will collapse if ground motions occur that equal or exceed the maximum considered earthquake (MCE) ground motions (the current FEMA 310 ground motion specification for

detailed seismic evaluation of buildings). These estimates of the score are based on limited observed and analytical data, and the probability of collapse is therefore approximate. For example, a final score of $S = 3$ implies there is a chance of 1 in 10^3 , or 1 in 1000, that the building will collapse if such ground motions occur. A final score of $S = 2$ implies there is a chance of 1 in 10^2 , or 1 in 100, that the building will collapse if such ground motions occur. (Additional information about the basis for the RVS scoring system is provided in the second edition of the companion FEMA 155 Report, *Rapid Visual Screening of Buildings for Potential Seismic Hazards: Supporting Documentation*.) An understanding and appreciation of the physical essence of the scoring system, as described above, will facilitate the interpretation of results from implementation of the RVS procedure.

4.2 Selection of RVS “Cut-Off” Score

One of the most difficult issues pertaining to rapid visual screening is answering the question, “What is an acceptable S ?” This is a question for the community that involves the costs of safety versus the benefits. The costs of safety include:

- the costs of reviewing and investigating in detail hundreds or thousands of buildings in order to identify some fraction of those that would actually sustain major damage in an earthquake; and
- the costs associated with rehabilitating those buildings finally determined to be unacceptably weak.

The most compelling benefit is the saving of lives and prevention of injuries due to reduced damage in those buildings that are rehabilitated. This reduced damage includes not only less material damage, but fewer major disruptions to daily lives and businesses. The identification of hazardous buildings and the mitigation of their hazards are critical because there are thousands of existing buildings in all parts of the United States that may suffer severe damage or possible collapse in the event of strong ground shaking. Such damage or

collapse can be accompanied by loss of life and serious injury. In a great earthquake deaths could number in the thousands.

Each community needs to engage in some consideration of these costs and benefits of seismic safety, and decide what value of S is an appropriate “cut-off” for their situation. The final decision involves many non-technical factors, and is not straightforward. Perhaps the best quantification of the risk inherent in modern building codes was a study regarding design practice by the National Bureau of Standards (NBS, 1980), which observed:

In selecting the target reliability it was decided, after carefully examining the resulting reliability indices for the many design situations, that a $\beta_0 = 3$ is a representative average value for many frequently used structural elements when they are subjected to gravity loading, while $\beta_0 = 2.5$ and $\beta_0 = 1.75$ are representative values for loads that include wind and earthquake, respectively³.

In other words, present design practice is such that a value of S of about 3 is appropriate for day-to-day loadings, and a value of about 2, or somewhat less, is appropriate for infrequent, but possible, earthquake loadings.

More recently, recommendations for seismic design criteria for new steel moment-frame buildings (SAC, 2000) concluded that:

...it is believed that...structures designed in accordance with [these recommendations] provide in excess of 90% confidence of being able to withstand [shaking that has a 2% probability of exceedance in 50 years] without global collapse....

This statement can be shown to be equivalent to the findings in the NBS (1980) study.

Unless a community itself considers the cost and benefit aspects of seismic safety, an S value of about 2.0 is a reasonable preliminary value to use within the context of RVS to differentiate adequate buildings from those potentially inadequate and thus requiring detailed review. Use of a higher cut-off S value implies greater desired safety but increased community-wide costs for evaluations and rehabilitation; use of a lower value of S equates to increased seismic risk and lower

short-term community-wide costs for evaluations and rehabilitation (prior to an earthquake).

Further guidance on cost and other societal implications of seismic rehabilitation of hazardous buildings is available in other publications of the FEMA report series on existing buildings (see FEMA-156 and FEMA-157, *Typical Costs for Seismic Rehabilitation of Buildings*, 2nd Edition, Volumes 1 and 2, and FEMA-255 and FEMA-256, *Seismic Rehabilitation of Federal Buildings – A Benefit/Cost Model*, Volumes 1 and 2 (VSP, 1994).

4.3 Prior Uses of the RVS Procedure

During the decade following publication of the first edition of the FEMA 154 *Handbook*, the rapid visual screening procedure was used by private-sector organizations and government agencies to evaluate more than 70,000 buildings nationwide (ATC, 2002). As reported at the FEMA 154 Users Workshop in San Francisco in September 2000 (see second edition of FEMA 155 report for additional information), these applications included surveys of (1) commercial buildings in Beverly Hills, California, (2) National Park Service facilities, (3) public buildings and designated shelters in southern Illinois; (4) U. S. Army facilities, (5) facilities of the U. S. Department of the Interior and (6) buildings in other local communities and for other government agencies. The results from some of these efforts are described below.

In its screening of 11,500 buildings using the FEMA 154 RVS procedure, the U. S. Army Corps of Engineers Civil Engineering Research Laboratory (CERL) used a cut-off score of 2.5, rather than 2.0 (S. Sweeney, oral communication, September 2000), with the specific intent of using a more conservative approach. As a result of the FEMA 154 screening, approximately 5,000 buildings had final S scores less than 2.5. These buildings, along with a subset of buildings that had FEMA 154 scores higher than 2.5, but were of concern for other reasons, were further evaluated in detail using the FEMA 178 *NEHRP Handbook for the Seismic Evaluation of Existing Buildings* [BSSC, 1992]). Results from the subsequent FEMA 178 evaluations indicated that some buildings that failed the FEMA 154 RVS procedure (that is, had scores less than 2.5) did not fail the FEMA 178 evaluations and that some that passed the FEMA 154 RVS procedure (with scores higher than 2.5) did not pass the FEMA 178 evaluation (that is, were found to have inadequate seismic resistance). This finding emphasizes the

³ β_0 as used in the National Bureau of Standards study is approximately equivalent to S as used herein.

concern identified at the beginning of this chapter that the use of FEMA 154 may not identify potentially earthquake hazardous buildings as such, and that buildings identified as potentially hazardous may prove to be adequate.

Other conclusions and recommendations pertaining to the use of the FEMA 154 RVS procedure that emanated from these applications included the following:

- Involve design professionals in RVS implementation whenever possible to ensure that the lateral-force-resisting structural systems are correctly identified (such identification is particularly difficult in buildings that have been remodeled and added to over the years);
- Conduct intensive training for screeners so that they fully understand how to implement the methodology, in all of its aspects;
- Inspect both the exterior and, if at all possible, the interior of the building;
- Review construction drawings as part of the screening process;
- Review soils information prior to implementation of the methodology in the field; and
- Interpret the results from FEMA 154 screenings in a manner consistent with the level of resources available for the screening (for example, cut-off scores may be dictated by budget constraints).

Most of these recommendations were incorporated in the updated RVS procedure described in this *Handbook*.

4.4 Other Possible Uses of the RVS Procedure

In addition to identifying potentially seismically hazardous buildings needing further evaluation, results from RVS surveys can also be used for other purposes, including: (1) designing seismic hazard mitigation programs for a community (or agency); (2) ranking a community's (or agency's) seismic rehabilitation needs; (3) developing inventories of buildings for use in regional earthquake damage and loss impact assessments; (4) developing inventories of buildings for use in planning postearthquake building safety evaluation efforts; and (5) developing building-specific seismic vulnerability information for purposes such as insurance rating,

decision making during building ownership transfers, and possible triggering of remodeling requirements during the permitting process.

Following are descriptions of how RVS results could be used for several of these purposes.

4.4.1 Using RVS Scores as a Basis for Hazardous Building Mitigation Programs

Communities need to develop hazard mitigation plans to establish a solid foundation for the detailed seismic evaluation and rehabilitation of buildings. In developing any hazardous buildings mitigation program, the cost effectiveness of the seismic evaluation and rehabilitation work must be determined. The costs should be evaluated against the direct benefits of the seismic rehabilitation program (that is, reduced physical damage, reduced injuries and loss of life). Additionally, secondary benefits to the community should be considered with the direct benefits. These secondary benefits are difficult to quantify in dollars, but must be considered. Secondary benefits are those that apply to the community as a whole. Examples include:

- reduced interruption to business;
- reduced potential for secondary damage (for example, fires) that could impact otherwise undamaged structures;
- reduced potential for traffic flow problems around areas of significant damage; and
- other reduced economic impacts.

The process of selecting buildings to be rehabilitated begins with the determination of the cut-off Structural Score, S , below which detailed building seismic evaluation is required (e.g., by use of the FEMA 310 procedures). Such a determination allows estimates to be made on the costs of additional seismic evaluation and rehabilitation work. From this the benefits are determined. The most cost-effective solution will be the one where the least amount is spent in direct costs to gain the greatest direct and secondary benefits.

After the RVS authority establishes the appropriate cut-off score and completes the screening process, it needs to determine the best way to notify building owners of the need for more review of buildings that score less than the cut-off (if the authority is not the owner of the buildings being screened). At the same time the community needs to develop the appropriate standards (for example, adoption of FEMA 356,

Prestandard and Commentary on the Seismic Rehabilitation of Buildings [ASCE, 2000]) to accomplish the goal of the mitigation program. Ultimately, the mitigation program needs to address those buildings that represent the largest potential threat to life safety and the community. Timelines for compliance with the new standards and the mitigation program should be developed on a priority basis, such that the first priority actions relate to those buildings posing the most significant risk, after which those posing a lesser risk are addressed.

4.4.2 Using RVS Data in Community Building Inventory Development

RVS data can be used to establish building inventories that characterize a community's seismic risk. For example, RVS data could be used to improve the HAZUS (NIBS, 1999) characterization of the local inventory, which has a default level based on population, economic factors, and regional trends. Similarly, RVS could be incorporated directly into a community's Geographic Information System (GIS), allowing the community to generate electronic and paper maps that reflect the building stock of the community. Electronic color coding of the various types of buildings under the RVS authority, based on their ultimate vulnerability, allows the community to see at a glance where the vulnerable areas of the community are found.

4.4.3 Using RVS Data to Plan Post-earthquake Building-Safety-Evaluation Efforts

In a postearthquake environment one of the initial response priorities is to determine rapidly the safety of buildings for continued occupancy. The procedure most often used is that represented in the ATC-20 Report, *Procedures for Postearthquake Safety Evaluation of Buildings* (ATC, 1989, 1995). This procedure is similar in nature to that of the RVS procedure in that initial rapid evaluations are performed to find those buildings that are obviously unsafe (Red placard) and those that have no damage or damage that does not pose a threat to continued occupancy (Green placard). All other buildings fall into a condition where occupancy will need to be restricted in some form (Yellow placard).

The database developed following the completion of the RVS process in a given community will be valuable in setting the priorities of where safety evaluation will be performed first, after a damaging earthquake. For example, a community could use HAZUS software, in combination with RVS-based inventory information, to determine areas where significant damage may exist for various earthquake scenarios. Similarly, a community could use an existing GIS containing RVS inventory data and computer-generated maps of strong ground shaking, such as the ShakeMaps developed by the USGS (ATC, in progress), to estimate the location and distribution of damaged buildings. With such information, community officials would be able to determine those areas where building safety evaluations should be conducted.

Later, the data collected during the postearthquake building safety evaluations could be added to the RVS authority's RVS-based building inventory database. Using GIS, maps can then be prepared showing the damage distribution within the community based on actual building damage. Building locations could be electronically color-coded in accordance with the color of the safety-evaluation placard that is placed on the building: Green, Yellow, or Red.

4.4.4 Resources Needed for the Various Uses of the RVS Procedure

For most applications of the RVS procedure, the resources needed to implement the process are similar, consisting principally of an RVS manager (the RVS authority), technical specialists to train screeners, a team of screeners, materials to be taken into the field (e.g., the *Handbook* and other items listed in Section 2.8), and building construction drawings. Most applications are assisted by the development and maintenance of a computerized database for recordkeeping and the use of geographic information systems (GIS). A matrix showing recommended resources for various FEMA 154 RVS applications is provided in Table 4-1.

Table 4-1 Matrix of Recommended Personnel and Material Resources for Various FEMA 154 RVS Applications*

<i>Application</i>	<i>Resources</i>						
	<i>RVS Manager</i>	<i>RVS Trainer</i>	<i>Screeners</i>	<i>Screening Equipment and Supplies</i>	<i>Building Drawings</i>	<i>Computerized Record Keeping System</i>	<i>GIS</i>
1. Ranking seismic rehabilitation needs	X	X	X	X	X	X	X
2. Designing seismic hazard mitigation programs	X	X	X	X	X	X	X
3. Developing inventories for regional earthquake damage and loss studies	X	X	X	X	X	X	X
4. Planning postearthquake building safety evaluation efforts	X	X	X	X	X	X	X
5. Developing building specific vulnerability information	X	X	X	X	X		

*It is recommended that rapid visual screening projects be carried out under the oversight of a design professional with significant experience in seismic design.

Example Application of Rapid Visual Screening

Presented in this chapter is an illustrative application of the rapid visual screening procedure in the hypothetical community of Anyplace USA. The RVS implementation process (as depicted in Figure 2-1) is described, from budget development to selection of the appropriate Data Collection Form, to the screening of individual buildings in the field. Prior to implementation of the RVS procedure, the RVS authority (the Building and Planning Department of Anyplace) has reviewed the *Handbook* and established the purpose for the RVS.

5.1 Step 1: Budget and Cost Estimation



The RVS authority has been instructed by the city council to conduct the RVS process to identify all buildings in the city, excluding detached single-family and two-family dwellings, that are potentially earthquake hazardous and that should be further evaluated by a design professional experienced in seismic design (the principal purpose of the RVS procedure). It is understood that, depending on the results of the RVS, the city council may adopt future ordinances that establish policy on when, how and by whom low-scoring buildings should be evaluated and on future seismic rehabilitation requirements. It is also desired that the results from the RVS be incorporated in the geographic information system that the city recently installed to map and describe facilities throughout the city, including all buildings and utility systems within the city limits.

The RVS authority has determined there are approximately 1,000 buildings in the city that are not detached single-family or two-family dwellings and that some of the buildings are at least 100 years old. The RVS authority plans (1) to conduct a pre-field data collection and evaluation process to examine and assess information in its existing files and to document building location, size, use, and other information

on the Data Collection Forms prior to field screening; (2) to review available building plans prior to field screening; (3) to inspect the interiors of buildings whenever possible; (4) to establish an electronic RVS record-keeping system that is compatible with its GIS; and (5) to train screeners prior to sending them into the field.

Costs to conduct these activities have been estimated, assuming an average of \$40 per hour (salary plus benefits) for personnel who perform data evaluation, screening, and record management. Costs are in 2001 dollars. It is assumed that three persons will carry out the pre-field data collection and evaluation process, that four two-person teams of design professionals will conduct the review of building plans and the field screening, that two persons will file all screening data, and that the entire RVS process will take approximately six months. Based on these rates and assumed times to conduct the various activities, the following RVS budget has been established:

1. Pre-field data collection, evaluation, and processing (1,000 buildings × 0.4 hr/building × \$40/hr)	\$16,000
2. Training, including trainer time (24 hours), screener time (8 hours per screener), and materials	4,000
3. Review of available building plans (500 plan sets × 0.75 hr/plan set × \$40/hr)	15,000
4. Field screening (1,000 buildings × 0.75 hr/building × \$40/hr)	30,000
5. Record-keeping system development	5,000
6. Electronic filing of Data Collection Forms, including verification of data input (1,000 forms × 0.75 hour/form × \$40/hour)	<u>30,000</u>
7. Subtotal	\$100,000
8. Management (10% of item 7)	<u>10,000</u>
9. Total	\$110,000

5.2 Step 2: Pre-Field Planning

During the pre-field planning process the RVS authority confirmed that the existing geographic information system was capable of being expanded to include RVS-related information and results. In addition, the RVS authority decided that sufficient soil information was available from the State Geologist to develop an overlay for their GIS containing soils information for the entire city. While not required as part of the RVS process, it was also determined that the city included an area that had isolated pockets of low liquefaction potential, and that there was no area with landslide potential. Consequently the RVS authority concluded that GIS overlays for liquefaction and landslide potential were not warranted.

The RVS authority also verified that the existing GIS had reference tables containing address information for most of the properties in the city (developed earlier from the tax assessor's files) and that these tables could be extracted and included in a new GIS-compatible electronic relational database containing the RVS results. It was also determined that other building and planning department's files contained reliable information on building name, use, size (height and area), structural system, and age for buildings built or remodeled within the last 30 years, and that Sanborn maps, which contain size, age, and other building attribute information (see Section 2.6.3) were available (at the local library) for most of the downtown sector.

Based on this information, the RVS authority confirmed its prior preliminary decision under Step 1 to develop an electronic RVS record keeping system (relational database) that could be imported into the existing GIS. The RVS authority also decided to focus on the downtown sector of Anyplace during the initial phase of the RVS field work, and to expand to the outlying areas later.

5.3 Step 3: Selection and Review of the Data Collection Form

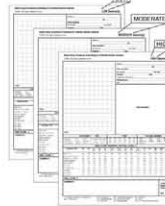

To choose the correct Data Collection Form, the RVS authority elected to establish the seismicity for Anyplace USA by using Method 2 (see Section 2.4.1), rather than by selecting the seismicity region from the maps in Appendix A. Method 2, using the zip-code option, provides more precision than the Appendix A maps which use county boundaries. Method 2 was executed by accessing the USGS seismic hazard web site (<http://geohazards.cr.usgs.gov/eq/>), selecting Hazard by Zip Code, entering the zip code, 91234, and obtaining spectral acceleration (SA) values for 0.2 second and 1.0 second for ground motions having a 2% probability of being exceeded in 50 years (see Figure 5-1). The values of 2.10 g and 0.88 g for 0.2 second and 1.0 second, respectively, were multiplied by 2/3 to obtain the reduced values of 1.40 g and 0.59 g, respectively, for 0.2



The input zip-code is 91234.

ZIP CODE	91234		
LOCATION	33.7754 Lat. -118.1860 Long.		
DISTANCE TO NEAREST GRID POINT	3.0229 kms		
NEAREST GRID POINT	33.8 Lat. -118.2 Long.		
Probabilistic ground motion values, in %g, at the Nearest Grid point are:			
	10%PE in 50 yr	5%PE in 50 yr	2%PE in 50 yr
PGA	51.809940	70.680931	96.476959
0.2 sec SA	118.997299	157.833496	210.003403
0.3 sec SA	114.200897	148.213104	194.634995
1.0 sec SA	42.566330	60.786320	88.084427

Figure 5-1 Screen capture of USGS web page showing SA values for 0.2 sec and 1.0 sec for ground motions having 2% probability of being exceeded in 50 years (values shown in boxes).

second and 1.0 second. These reduced values were compared to the criteria in Table 2-1 to determine that the reduced (using the 2/3 factor) USGS assigned motions met the “high seismicity” criteria for both short-period and long-period motions (that is, 1.40 g is greater than 0.5 g for the 0.2 second [short-period] motions, and 0.59 g is greater than 0.2 g for the 1.0 second [long-period] motions). All other zip codes in Anyplace were similarly input to the USGS web site, and the results indicated high seismicity in all cases. On this basis the RVS authority selected the Data Collection Form for high seismicity (Figure 5-2).

Using the checklist of Table 2-3, the RVS authority reviewed the Data Collection Form to determine if the occupancy categories and occupancy loads were useful for their purposes and evaluated other parameters on the form, deciding that no changes were needed. The RVS authority also conferred with the chief building official, the department’s plan checkers, and local design professionals to establish key seismic code adoption dates for the various building lateral-load-resisting systems considered by the RVS and for anchorage of heavy cladding. It was determined that Anyplace adopted seismic codes for W1, W2, S1, S5, C1, C3, RM1, and RM2 building types in 1933, and that seismic codes were never adopted for URM buildings (after 1933 they were no longer permitted to be built). For S2, S3, S4 and PC2 buildings, it was assumed for purposes of the RVS procedure that seismic codes were adopted in 1941, using the default year recommended in Section 2.4.2. For PC1 buildings, it was assumed that seismic codes were first adopted in 1973 (per the guidance provided in Section 2.4.2). It was also determined that seismically rehabilitated URM buildings should be treated as buildings designed in accordance with a seismic code (that is, treated as if they were designed in 1933 or thereafter). Because Anyplace has been consistently adopting the *Uniform Building Code* since the early 1960s, benchmark years for all building types, except URM, were taken from the “UBC” column in Table 2-2. The year in which seismic anchorage requirements for heavy cladding was determined to be 1967. These findings were indicated on the Quick Reference Guide (See Figure 5-3).

5.4 Step 4: Qualifications and Training for Screeners

Anyplace USA selected RVS screeners from two sources: the staff of the Department of Building and Planning, and junior-level engineers from local engineering offices, who were hired on a temporary consulting basis. Training was carried out by one of the department’s most experienced plan checkers, who spent approximately 24 hours reading the FEMA 154 *Handbook* and preparing training materials.

As recommended in this *Handbook*, the training was conducted in a classroom setting and consisted of: (1) discussions of lateral-force-resisting systems and how they behave when subjected to seismic loads; (2) how to use the Data Collection Form and the Quick Reference Guide; (3) a review of the Basic Structural Hazard Scores and Score Modifiers; (4) what to look for in the field; (5) how to account for uncertainty; and (6) an exercise in which screeners were shown interior and exterior photographs of buildings and asked to identify the lateral-load-resisting system and vertical and plan irregularities. The training class also included focused group interaction sessions, principally in relation to the identification of structural systems and irregularities using exterior and interior photographs. Screeners were also instructed on items to take into the field.

5.5 Step 5: Acquisition and Review of Pre-Field Data



As described in the Pre-Field Planning process (Step 2 above), the RVS authority of Anyplace USA already had electronic GIS reference tables containing street addresses and parcel numbers for most of the buildings in the city. These data (addresses and parcel numbers) were extracted from the electronic GIS system (see screen capture of GIS display showing parcel number and other available information for an example site, Figure 5-4) and imported into a standard off-the-shelf electronic database as a table. To facilitate later

Rapid Visual Screening of Buildings for Potential Seismic Hazards (FEMA 154)

Quick Reference Guide (for use with Data Collection Form)

1. Model Building Types and Critical Code Adoption and Enforcement Dates		Year Seismic Codes Initially Adopted and Enforced*	Benchmark Year when Codes Improved
Structural Types			
W1	Light wood frame, residential or commercial, ≤ 5000 square feet	<u>1933</u>	<u>1976</u>
W2	Wood frame buildings, > 5000 square feet.	<u>1933</u>	<u>1976</u>
S1	Steel moment-resisting frame	<u>1933</u>	<u>1994</u>
S2	Steel braced frame	<u>1941</u>	<u>1988</u>
S3	Light metal frame	<u>1941</u>	<u>None</u>
S4	Steel frame with cast-in-place concrete shear walls	<u>1941</u>	<u>1976</u>
S5	Steel frame with unreinforced masonry infill	<u>1933</u>	<u>None</u>
C1	Concrete moment-resisting frame	<u>1933</u>	<u>1976</u>
C2	Concrete shear wall	<u>1941</u>	<u>1976</u>
C3	Concrete frame with unreinforced masonry infill	<u>1933</u>	<u>None</u>
PC1	Tilt-up construction	<u>1973</u>	<u>1997</u>
PC2	Precast concrete frame	<u>1941</u>	<u>None</u>
RM1	Reinforced masonry with flexible floor and roof diaphragms	<u>1933</u>	<u>1997</u>
RM2	Reinforced masonry with rigid diaphragms	<u>1933</u>	<u>1976</u>
URM	Unreinforced masonry bearing-wall buildings	<u>1933</u>	<u>N/A</u>
*Not applicable in regions of low seismicity			

2. Anchorage of Heavy Cladding	
Year in which seismic anchorage requirements were adopted:	<u>1967</u>

3. Occupancy Loads			
Use	Square Feet, Per Person	Use	Square Feet, Per Person
Assembly	varies, 10 minimum	Industrial	200-500
Commercial	50-200	Office	100-200
Emergency Services	100	Residential	100-300
Government	100-200	School	50-100

4. Score Modifier Definitions	
<i>Mid-Rise:</i>	4 to 7 stories
<i>High-Rise:</i>	8 or more stories
<i>Vertical Irregularity:</i>	Steps in elevation view; inclined walls; building on hill; soft story (e.g., house over garage); building with short columns; unbraced cripple walls.
<i>Plan Irregularity</i>	Buildings with re-entrant corners (L, T, U, E, + or other irregular building plan); buildings with good lateral resistance in one direction but not in the other direction; eccentric stiffness in plan, (e.g. corner building, or wedge-shaped building, with one or two solid walls and all other walls open).
<i>Pre-Code:</i>	Building designed and constructed prior to the year in which seismic codes were first adopted and enforced in the jurisdiction; use years specified above in Item 1; default is 1941, except for PC1, which is 1973.
<i>Post-Benchmark:</i>	Building designed and constructed after significant improvements in seismic code requirements (e.g., ductile detailing) were adopted and enforced; the benchmark year when codes improved may be different for each building type and jurisdiction; use years specified above in Item 1 (see Table 2-2 of FEMA 154 <i>Handbook</i> for additional information).
<i>Soil Type C:</i>	Soft rock or very dense soil; S-wave velocity: 1200 – 2500 ft/s; blow count > 50; or undrained shear strength > 2000 psf.
<i>Soil Type D:</i>	Stiff soil; S-wave velocity: 600 – 1200 ft/s; blow count: 15 – 50; or undrained shear strength: 1000 – 2000 psf.
<i>Soil Type E:</i>	Soft soil; S-wave velocity < 600 ft/s; or more than 100 ft of soil with plasticity index > 20, water content > 40%, and undrained shear strength < 500 psf.

Figure 5-3 Quick Reference Guide for Anyplace USA showing entries for years in which seismic codes were first adopted and enforced and benchmark years.

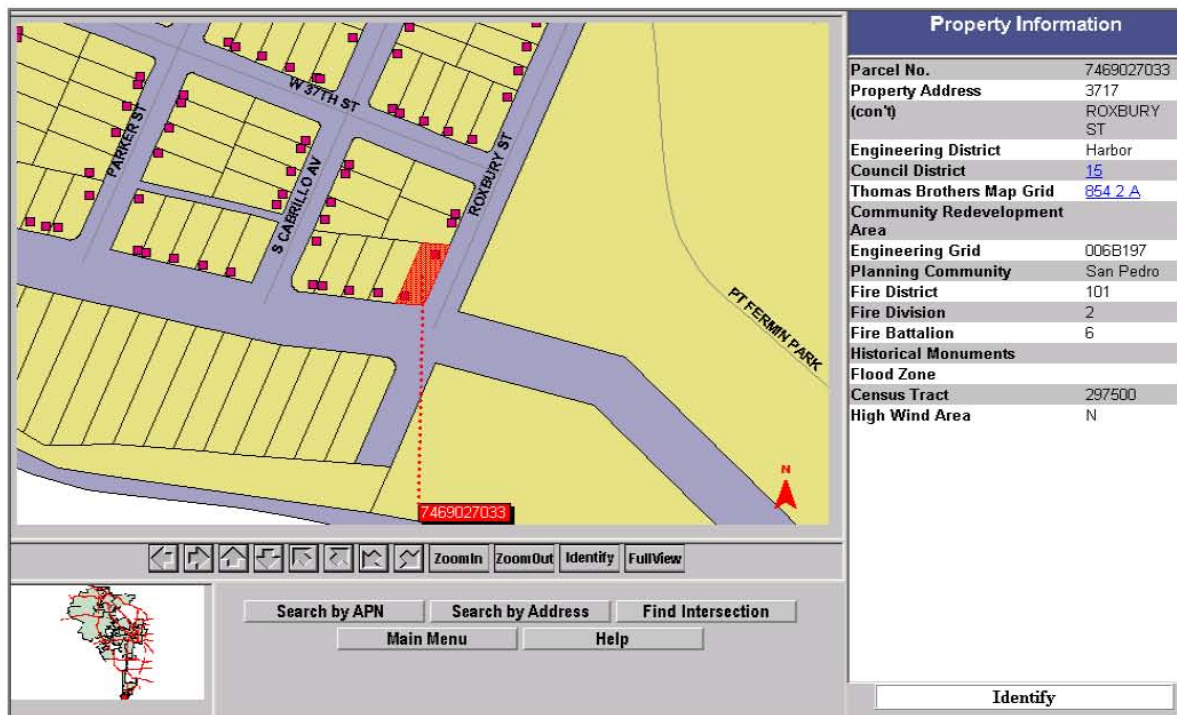

Figure 5-4 Property information at example site in city's geographic information system.

use in the GIS, the street addresses were subdivided into the following fields: the numeric part of the address; the street prefix (for example, "North"); the street name; and the street suffix (for example, "Drive"). A zip code field was added, zip codes for each street address were obtained using zip code lists available from the US Postal Service, and these data were also added to the database. This process yielded 950 street addresses, with parcel number and zip code, and established the initial information in Anyplace's electronic "Building RVS Database".

Permitting files, which contained data on buildings constructed or remodeled within the last 30 years (including parcel number), were then reviewed to obtain information on building name (if available), use, building height (height in feet and number of stories), total floor area, age (year built), and structural system. This process yielded information (from paper file folders) on approximately 500 buildings. Fields were added to the Building RVS Database for each of these attributes and data were added to the appropriate records (searching on parcel number) in the database; in the case of structure type, the entry included an asterisk to denote uncertainty. If an address was missing in the database, a new record containing that address and related data was added. On average, 30 minutes per building were required to extract the correct information from

the permitting files and insert it into the electronic database.

The city's librarian provided copies of available Sanborn maps, which were reviewed to identify information on number of stories, year built, building size (square footage), building use, and limited information on structural type for approximately 200 buildings built prior to 1960. These data were added to the appropriate record (searching on address) in the Building RVS Database; in the case of structure type, the entry included an asterisk to denote uncertainty. If an address was missing in the database, a new record containing that address and related data was added. For this effort, 45 minutes per building, on average, were required to extract the correct information from the Sanborn maps and insert it into the electronic database. During the pre-field data collection and review process the RVS authority also obtained an electronic file of soils data (characterized in terms of the soil types described in Section 2.6.6) from the State Geologist and created an overlay of this information in the city's GIS system. Points defined by the addresses in the GIS reference tables (including newly identified addresses added to the references tables as a result of the above-cited efforts) were combined with the soils type overlay, and soil type was then assigned to each point (address) by a standard GIS operating

procedure. The soils type information for each address was then transferred back to the Building RVS Database table into a new field for each building's soil type.

Based on the above efforts, Anyplace's Building RVS Database was expanded to include approximately 1,000 records with address, parcel number, zip code, and soils information, and approximately 700 of these records also contained information on building name (if any), use, number of stories, total floor area, year built, and structure type.

5.6 Step 6: Review of Construction Documents

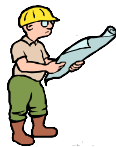

Fortuitously, the city had retained microfilm copies of building construction documents submitted with each permit filing during the last 30 years, and copies of these documents were available for 500 buildings (the same subset described in Step 5 above). Teams consisting of one building department staff member and one consulting engineer reviewed these documents to verify, or identify, the lateral-force-resisting system for each building. Any new or revised information on structure type derived as part of this process was then inserted in the Building RVS Database, in which case, previously existing information in this field, along with the associated asterisk denoting uncertainty, was removed. On average, this effort required approximately 30 minutes per plan set, including database corrections.

5.7 Step 7: Field Screening of Buildings

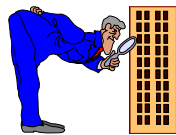

Immediately prior to field screening (that is, at the conclusion of Step 6 above), the RVS authority acquired an electronic template of the Data Collection Form from the web site of the Applied Technology Council (www.atcouncil.org) and used this template to create individual Data Collection Forms for each record in the Building RVS Database. Each form contained unique information in the building identification portion of the form, with "Parcel Number" shown as

"Other Identifiers" information (see Figure 5-2). In those instances where structure type information was included in the database, this information was also added as "Other Identifiers" information, with an asterisk if still uncertain. Soil type information was indicated on each form by circling the appropriate letter (and brief description) in the "Soil Type" section of the form (see Figure 5-2).

The Data Collection Forms, including blank forms for use with buildings not yet in the Building RVS Database, were distributed to the RVS screeners along with their RVS assignments (on a block-by-block basis). Screeners were advised that some of the database information printed on the form (e.g., number of stories, structure type denoted with an *) would need to be verified in the field, that approximately 700 of the 1,000 Data Collection Forms had substantially complete, but not necessarily verified, information in the location portion of the form, and that all 1,000 forms had street, address, parcel number, zip code, and soil type information.

Prior to field work, each screener was reminded to complete the Data Collection Form at each site before moving on to the next site, including adding his or her name as the screener and the screening date (in the building identification section of the form).

Following are several examples illustrating rapid visual screening in the field and completion of the Data Collection Form. Some examples use forms containing relatively complete building identification information, including structure type, obtained during the pre-field data acquisition and review process (Step 5); others use forms containing less complete building identification information; and still others use blank forms completely filled in at the site.

Example 1: 3703 Roxbury Street

Upon arriving at the site the screeners observed the building as a whole (Figure 5-5) and began the process of verifying the information in the building identification portion of the form (upper right corner), starting with the street address. The building's lateral-force-resisting system (S2, steel braced frame) was verified by looking at the building with binoculars (see Figure 5-6). The number of stories (10), use (office), and year built (1986) were also confirmed by inspection. The base dimensions of the building were estimated by pacing off the distance along each face, assuming 3 feet per stride, resulting in the determination that it was 75 ft x 100 ft in plan.

Scale:

Address: 3703 Roxbury St.
Anyplace Zip 91234
 Other Identifiers Parcel 7469027035; S2
 No. Stories 10 Year Built 1986
 Screener A. Jones/D. Taylor Date 2/28/01
 Total Floor Area (sq. ft.) 76,000 Sq. ft.
 Building Name Smith & Co.
 Use Office

OCCUPANCY			SOIL		TYPE						FALLING HAZARDS			
Assembly	Govt	<u>Office</u>	Number of Persons		A	B	C	<u>D</u>	E	F	<input type="checkbox"/>	<input type="checkbox"/>	<input type="checkbox"/>	<input type="checkbox"/>
Commercial	Historic	Residential	0 - 10	11 - 100	Hard Rock	Avg. Rock	Dense Soil	Stiff Soil	Soft Soil	Poor Soil	Unreinforced Chimneys	Parapets	Cladding	Other:
Emer. Services	Industrial	School	<u>101-1000</u>	1000+										

BASIC SCORE, MODIFIERS, AND FINAL SCORE, S															
BUILDING TYPE	W1	W2	S1 (MRF)	<u>S2 (BR)</u>	S3 (LM)	S4 (RC SW)	S5 (URM INF)	C1 (MRF)	C2 (SW)	C3 (URM INF)	PC1 (TU)	PC2	RM1 (FD)	RM2 (RD)	URM
Basic Score	4.4	3.8	2.8	<u>3.0</u>	3.2	2.8	2.0	2.5	2.8	1.6	2.6	2.4	2.8	2.8	1.8
Mid Rise (4 to 7 stories)	N/A	N/A	+0.2	+0.4	N/A	+0.4	+0.4	+0.4	+0.4	+0.2	N/A	+0.2	+0.4	+0.4	0.0
High Rise (> 7 stories)	N/A	N/A	+0.6	<u>+0.8</u>	N/A	+0.8	+0.8	+0.6	+0.8	+0.3	N/A	+0.4	N/A	+0.6	N/A
Vertical Irregularity	-2.5	-2.0	-1.0	-1.5	N/A	-1.0	-1.0	-1.5	-1.0	-1.0	N/A	-1.0	-1.0	-1.0	-1.0
Plan Irregularity	-0.5	-0.5	-0.5	-0.5	-0.5	-0.5	-0.5	-0.5	-0.5	-0.5	-0.5	-0.5	-0.5	-0.5	-0.5
Pre-Code	0.0	-1.0	-1.0	-0.8	-0.6	-0.8	-0.2	-1.2	-1.0	-0.2	-0.8	-0.8	-1.0	-0.8	-0.2
Post-Benchmark	+2.4	+2.4	+1.4	+1.4	N/A	+1.6	N/A	+1.4	+2.4	N/A	+2.4	N/A	+2.8	+2.6	N/A
Soil Type C	0.0	-0.4	-0.4	-0.4	-0.4	-0.4	-0.4	-0.4	-0.4	-0.4	-0.4	-0.4	-0.4	-0.4	-0.4
Soil Type D	0.0	-0.8	-0.6	<u>-0.6</u>	-0.6	-0.6	-0.4	-0.6	-0.6	-0.4	-0.6	-0.6	-0.6	-0.6	-0.6
Soil Type E	0.0	-0.8	-1.2	-1.2	-1.0	-1.2	-0.8	-1.2	-0.8	-0.8	-0.4	-1.2	-0.4	-0.6	-0.8

FINAL SCORE, S	<u>3.2</u>
COMMENTS	

Detailed Evaluation Required

YES NO

* = Estimated, subjective, or unreliable data
 DNK = Do Not Know
 BR = Braced frame
 FD = Flexible diaphragm
 LM = Light metal
 MRF = Moment-resisting frame
 RC = Reinforced concrete
 RD = Rigid diaphragm
 SW = Shear wall
 TU = Tilt up
 URM INF = Unreinforced masonry infill

Figure 5-8 Completed Data Collection Form for Example 1, 3703 Roxbury Street.

Example 2: 3711 Roxbury Street

Upon arrival at the site, the screeners observed the building as a whole (Figure 5-9). Unlike Example 1, there was little information in the building identification portion of the form (only street address, zip code, and parcel number were provided). The screeners determined the number of stories to be 12 and the building use to be commercial and office. They paced off the building plan dimensions to estimate the plan size to be 58 feet x 50 feet. Based on this information, the total square footage was estimated to be 34,800 square feet (12 x 50 x 58), and the number of stories, use, and square footage were written on the form. Based on a review of information in Appendix D of this *Handbook*, the year of construction was estimated to be 1944 and this date was written on the form.

A sketch of the plan and elevation views of the building were drawn in the “Sketch” portion of the form.

The building use was circled in the “Occupancy” portion, and from Section 3 of the Quick Reference Guide, the occupancy load was estimated at $34,800/135^{\diamond} = 258$. Hence, the occupancy range of 101-1000 was circled.

The cornices at roof level were observed, and entered on the form.

Noting that the estimated construction date was 1944 and that it was a 12-story building, a review of the material in Table D-6 (Appendix D), indicated that the likely options for building type were S1, S2, S5, C1, C2, or C3. On more careful examination of the building exterior with the use of binoculars (see Figure 5-10), it was determined the building was type C3, and this alpha-numeric code, and accompanying Basic Structural Score, were circled on the Data Collection Form.

Because the building was high-rise (more than 7 stories), this modifier was circled, and because the four individual towers extending above the base represented a vertical irregularity, this modifier was circled. Noting that the soil is type D, as already determined during the pre-field data acquisition phase and indicated in the Soil Type portion of the form, the modifier for Soil Type D was circled.

By adding the column of circled numbers, a Final Score of 0.5 was determined. Because this score was less than the cut-off score of 2.0, the building required a detailed evaluation by an experienced seismic design professional. Lastly,

[♦] The “135” value is the approximate average of the mid-range occupancy load for commercial buildings (125 sq. ft. per person) and the mid-range occupancy load for office buildings (150 sq. ft. per person).

an instant camera photo of the building was attached to the Data Collection Form (a completed version of the form is provided in Figure 5-11).



Figure 5-9 Exterior view of 3711 Roxbury.



Figure 5-10 Close-up view of 3711 Roxbury Street building exterior showing infill frame construction.

Plan @ 2nd floor

Elevation

Scale:

Address: 3711 Roxbury St.
Anyplace Zip 91234

Other Identifiers Parcel 7469027034

No. Stories 12 Year Built 1944

Screener A. Jones/D. Taylor Date 2/28/01

Total Floor Area (sq. ft.) 34,800

Building Name _____

Use Commercial and Offices above

OCCUPANCY		SOIL		TYPE						FALLING HAZARDS					
<input checked="" type="checkbox"/> Assembly <input checked="" type="checkbox"/> Commercial <input type="checkbox"/> Emer. Services	<input type="checkbox"/> Govt <input type="checkbox"/> Historic <input type="checkbox"/> Industrial	<input checked="" type="checkbox"/> Office <input type="checkbox"/> Residential <input type="checkbox"/> School	Number of Persons <input checked="" type="checkbox"/> 0-10 <input type="checkbox"/> 11-100 <input type="checkbox"/> 101-1000 <input type="checkbox"/> 1000+		<input type="checkbox"/> A Hard Rock	<input type="checkbox"/> B Avg. Rock	<input type="checkbox"/> C Dense Soil	<input checked="" type="checkbox"/> D Stiff Soil	<input type="checkbox"/> E Soft Soil	<input type="checkbox"/> F Poor Soil	<input type="checkbox"/> Unreinforced Chimneys	<input type="checkbox"/> Parapets	<input type="checkbox"/> Cladding	<input checked="" type="checkbox"/> Other: <u>Cornices</u>	
BASIC SCORE, MODIFIERS, AND FINAL SCORE, S															
BUILDING TYPE	W1	W2	S1 (MRF)	S2 (BR)	S3 (LM)	S4 (RC SW)	S5 (URM INF)	C1 (MRF)	C2 (SW)	C3 (URM INF)	PC1 (TU)	PC2	RM1 (FD)	RM2 (RD)	URM
Basic Score	4.4	3.8	2.8	3.0	3.2	2.8	2.0	2.5	2.8	1.6	2.6	2.4	2.8	2.8	1.8
Mid Rise (4 to 7 stories)	N/A	N/A	+0.2	+0.4	N/A	+0.4	+0.4	+0.4	+0.4	+0.2	N/A	+0.2	+0.4	+0.4	0.0
High Rise (> 7 stories)	N/A	N/A	+0.6	+0.8	N/A	+0.8	+0.8	+0.6	+0.8	+0.3	N/A	+0.4	N/A	+0.6	N/A
Vertical Irregularity	-2.5	-2.0	-1.0	-1.5	N/A	-1.0	-1.0	-1.5	-1.0	-1.0	N/A	-1.0	-1.0	-1.0	-1.0
Plan irregularity	-0.5	-0.5	-0.5	-0.5	-0.5	-0.5	-0.5	-0.5	-0.5	-0.5	-0.5	-0.5	-0.5	-0.5	-0.5
Pre-Code	0.0	-1.0	-1.0	-0.8	-0.6	-0.8	-0.2	-1.2	-1.0	-0.2	-0.8	-0.8	-1.0	-0.8	-0.2
Post-Benchmark	+2.4	+2.4	+1.4	+1.4	N/A	+1.6	N/A	+1.4	+2.4	N/A	+2.4	N/A	+2.8	+2.6	N/A
Soil Type C	0.0	-0.4	-0.4	-0.4	-0.4	-0.4	-0.4	-0.4	-0.4	-0.4	-0.4	-0.4	-0.4	-0.4	-0.4
Soil Type D	0.0	-0.8	-0.6	-0.6	-0.6	-0.6	-0.4	-0.6	-0.6	-0.4	-0.6	-0.6	-0.6	-0.6	-0.6
Soil Type E	0.0	-0.8	-1.2	-1.2	-1.0	-1.2	-0.8	-1.2	-0.8	-0.8	-0.4	-1.2	-0.4	-0.6	-0.8
FINAL SCORE, S	<u>0.5</u>														
COMMENTS														Detailed Evaluation Required <input checked="" type="checkbox"/> YES <input type="checkbox"/> NO	

* = Estimated, subjective, or unreliable data
 DNK = Do Not Know
 BR = Braced frame
 FD = Flexible diaphragm
 LM = Light metal
 MRF = Moment-resisting frame
 RC = Reinforced concrete
 RD = Rigid diaphragm
 SW = Shear wall
 TU = Tilt up
 URM INF = Unreinforced masonry infill

Figure 5-11 Completed Data Collection Form for Example 2, 3711 Roxbury Street.

Example 3: 5020 Ebony Drive

Example 3 was a high-rise residential building (Figure 5-12) in a new part of the city in which new development had begun within the last few years. The building was not included in the electronic Building RVS Database, and consequently there was not a partially prepared Data Collection Form for this building. Based on visual inspection, the screeners determined that the building had 22 stories, including a tall-story penthouse, estimated that it was designed in 1996, and concluded that its use was both commercial (in the first story) and residential in the upper stories. The screeners paced off the building plan dimensions to estimate the plan size to be approximately 270 feet x 180 feet. Based on this information and considering the symmetric but non-rectangular floor plan, the total square footage was estimated to be 712,800 square feet. These data were written on the form, along with the names of the screeners and the date of the screening. The screeners also drew a sketch of a portion of the plan view of the building in the space on the form allocated for a “Sketch”.

The building use (commercial and residential) was circled in the “Occupancy” portion, and from Section 3 of the Quick Reference Guide, the occupancy load was estimated at $712,800/200 = 3,564$. Based on this information, the occupancy range of 1000+ was circled.

While the screeners reasonably could have assumed a type D soil, which was the condition at the adjacent site approximately $\frac{1}{2}$ mile away, they concluded they had no basis for assigning a soil type. Hence they followed the instructions in the *Handbook* (Section 3.4), which specifies that if there is no basis for assigning a soil type, soil type E should be assumed. Accordingly, this soil type was circled on the form.

Given the design date of 1996, the anchorage for the heavy cladding on the exterior of the building was assumed to have been designed to meet the anchorage requirements initially adopted in 1967 (per the information on the Quick Reference Guide). No other falling hazards were observed.

The window spacing in the upper stories and the column spacing at the first floor level indicated the building was either a steel moment-frame building, or a concrete moment-frame building. The screeners attempted to view the interior but were not provided with permission to do so. They elected to indicate that the building was either an S1 or C1 type on the Data Collection Form and



Figure 5-12 Exterior view of 5020 Ebony Drive.

circled both types, along with their Basic Structural Scores. In addition, the screeners circled the modifiers for high rise (8 stories or more) and post-benchmark year, given that the estimated design date (1996) occurred after the benchmark years for both S1 and C1 building types (per the information on the Quick Reference Guide). They also circled the modifier for soil type E (in both the S1 and C1 columns).

By adding the circled numbers in both the S1 and C1 columns, Final Scores of 3.6 and 3.3 respectively were determined for the two building types. Because both scores were greater than the cut-off score of 2.0, a detailed evaluation of the building by an experienced seismic design professional was not required. Before leaving the site, the screeners photographed the building and attached the photo to the Data Collection Form. A completed version of the Data Collection Form is provided in Figure 5-13.

Section of Plan View

Address: 5020 Ebony Drive
Anyplace Zip 91011

Other Identifiers _____

No. Stories 22 Year Built 1996

Screener A. Jones/D. Taylor Date 2/28/01

Total Floor Area (sq. ft.) 712,800

Building Name _____

Use Residential and Commercial

Scale: _____

OCCUPANCY			SOIL		TYPE						FALLING HAZARDS				
Assembly	Govt	Office	Number of Persons		A	B	C	D	E	F	<input type="checkbox"/>	<input type="checkbox"/>	<input type="checkbox"/>	<input type="checkbox"/>	
Commercial	Historic	Residential	0-10	11-100	Hard Rock	Avg Rock	Dense Soil	Stiff Soil	Soft Soil	Poor Soil	Unreinforced Chimneys	Parapets	Cladding	Other:	
Emer Services	Industrial	School	101-1000	1000+											

BASIC SCORE, MODIFIERS, AND FINAL SCORE, S															
BUILDING TYPE	W1	W2	S1 (MRF)	S2 (BR)	S3 (LM)	S4 (RC SW)	S5 (URM INF)	C1 (MRF)	C2 (SW)	C3 (URM INF)	PC1 (TU)	PC2	RM1 (FD)	RM2 (RD)	URM
Basic Score	4.4	3.8	2.8	3.0	3.2	2.8	2.0	2.5	2.8	1.6	2.6	2.4	2.8	2.8	1.8
Mid Rise (4 to 7 stories)	N/A	N/A	+0.2	+0.4	N/A	+0.4	+0.4	+0.4	+0.4	+0.2	N/A	+0.2	+0.4	+0.4	0.0
High Rise (> 7 stories)	N/A	N/A	+0.6	+0.8	N/A	+0.8	+0.8	+0.6	+0.8	+0.3	N/A	+0.4	N/A	+0.6	N/A
Vertical Irregularity	-2.5	-2.0	-1.0	-1.5	N/A	-1.0	-1.0	-1.5	-1.0	-1.0	N/A	-1.0	-1.0	-1.0	-1.0
Plan irregularity	-0.5	-0.5	-0.5	-0.5	-0.5	-0.5	-0.5	-0.5	-0.5	-0.5	-0.5	-0.5	-0.5	-0.5	-0.5
Pre-Code	0.0	-1.0	-1.0	-0.8	-0.6	-0.8	-0.2	-1.2	-1.0	-0.2	-0.8	-0.8	-1.0	-0.8	-0.2
Post-Benchmark	+2.4	+2.4	+1.4	+1.4	N/A	+1.6	N/A	+1.4	+2.4	N/A	+2.4	N/A	+2.8	+2.6	N/A
Soil Type C	0.0	-0.4	-0.4	-0.4	-0.4	-0.4	-0.4	-0.4	-0.4	-0.4	-0.4	-0.4	-0.4	-0.4	-0.4
Soil Type D	0.0	-0.8	-0.6	-0.6	-0.6	-0.6	-0.4	-0.6	-0.6	-0.4	-0.6	-0.6	-0.6	-0.6	-0.6
Soil Type E	0.0	-0.8	-1.2	-1.2	-1.0	-1.2	-0.8	-1.2	-0.8	-0.8	-0.4	-1.2	-0.4	-0.6	-0.8
FINAL SCORE, S			3.6				3.3								

COMMENTS *Screeners could not determine if building type was C1 or S1; hence both types were scored, with similar results.*

Detailed Evaluation Required

YES NO

* = Estimated, subjective, or unreliable data
 DNK = Do Not Know
 BR = Braced frame
 FD = Flexible diaphragm
 LM = Light metal
 MRF = Moment-resisting frame
 RC = Reinforced concrete
 RD = Rigid diaphragm
 SW = Shear wall
 TU = Tilt up
 URM INF = Unreinforced masonry infill

Figure 5-13 Completed Data Collection Form for Example 3, 5020 Ebony Drive.

Plan View

Address: 1450 Addison Avenue
Anyplace Zip 91230

Other Identifiers Parcel 16287654958

No. Stories 1 Year Built 1990

Screener A. Jones/D. Taylor Date 2/28/01

Total Floor Area (sq. ft.) 10,200

Building Name _____

Use Commercial

Scale: _____

OCCUPANCY			SOIL		TYPE						FALLING HAZARDS			
Commercial	Govt	Office	11-100	1000+	A	B	C	D	E	F	<input type="checkbox"/>	<input type="checkbox"/>	<input type="checkbox"/>	<input type="checkbox"/>
Emer. Services	Historic	Residential			0-10	101-1000	Hard Rock	Avg Rock	Dense Soil	Stiff Soil	Soft Soil	Poor Soil	Unreinforced Chimneys	Parapets

BASIC SCORE, MODIFIERS, AND FINAL SCORE, S															
BUILDING TYPE	W1	W2	S1 (MRF)	S2 (BR)	S3 (LM)	S4 (RC SW)	S5 (URM INF)	C1 (MRF)	C2 (SW)	C3 (URM INF)	PC1 (TU)	PC2	RM1 (FD)	RM2 (RD)	URM
Basic Score	4.4	3.8	2.8	3.0	3.2	2.8	2.0	2.5	2.8	1.6	2.6	2.4	2.8	2.8	1.8
Mid Rise (4 to 7 stories)	N/A	N/A	+0.2	+0.4	N/A	+0.4	+0.4	+0.4	+0.4	+0.2	N/A	+0.2	+0.4	+0.4	0.0
High Rise (> 7 stories)	N/A	N/A	+0.6	+0.8	N/A	+0.8	+0.8	+0.6	+0.8	+0.3	N/A	+0.4	N/A	+0.6	N/A
Vertical Irregularity	-2.5	-2.0	-1.0	-1.5	N/A	-1.0	-1.0	-1.5	-1.0	-1.0	N/A	-1.0	-1.0	-1.0	-1.0
Plan irregularity	-0.5	-0.5	-0.5	-0.5	-0.5	-0.5	-0.5	-0.5	-0.5	-0.5	-0.5	-0.5	-0.5	-0.5	-0.5
Pre-Code	0.0	-1.0	-1.0	-0.8	-0.6	-0.8	-0.2	-1.2	-1.0	-0.2	-0.8	-0.8	-1.0	-0.8	-0.2
Post-Benchmark	+2.4	+2.4	+1.4	+1.4	N/A	+1.6	N/A	+1.4	+2.4	N/A	+2.4	N/A	+2.8	+2.6	N/A
Soil Type C	0.0	-0.4	-0.4	-0.4	-0.4	-0.4	-0.4	-0.4	-0.4	-0.4	-0.4	-0.4	-0.4	-0.4	-0.4
Soil Type D	0.0	-0.8	-0.6	-0.6	-0.6	-0.6	-0.4	-0.6	-0.6	-0.4	-0.6	-0.6	-0.6	-0.6	-0.6
Soil Type E	0.0	-0.8	-1.2	-1.2	-1.0	-1.2	-0.8	-1.2	-0.8	-0.8	-0.4	-1.2	-0.4	-0.6	-0.8

FINAL SCORE, S 5.3

<p>COMMENTS</p> 	<p>Detailed Evaluation Required</p> <p>YES <input type="radio"/> NO <input checked="" type="radio"/></p>
------------------------------------	--

* = Estimated, subjective, or unreliable data BR = Braced frame MRF = Moment-resisting frame SW = Shear wall
 DNK = Do Not Know FD = Flexible diaphragm RC = Reinforced concrete TU = Tilt up
 LM = Light metal RD = Rigid diaphragm URM INF = Unreinforced masonry infill

Figure 5-16 Completed Data Collection Form for Example 4, 1450 Addison Avenue.

5.8 Step 8: Transferring the RVS Field Data to the Electronic Building RVS Database



The last step in the implementation of rapid visual screening for Anyplace USA was transferring the information on the RVS Data Collection Forms into the relational electronic Building RVS Database. This required that all photos and sketches on the forms be scanned and numbered (for reference purposes), and that additional fields (and tables) be added to the database for those attributes not originally included in the database.

For quality control purposes, data were entered separately into two different versions of the electronic database, except photographs and

sketches, which were scanned only once. A double-entry data verification process was then used, whereby the data from one database were compared to the same entries in the second database to identify those entries that were not exactly the same. Non-identical entries were examined and corrected as necessary. The entire process, including scanning of sketches and photographs, required approximately 45 minutes per Data Collection Form.

After the electronic Building RVS Database was verified, it was imported into the city's GIS, thereby providing Anyplace with a state-of-the-art capability to identify and plot building groups based on any set of criteria desired by the city's policy makers. Photographs and sketches of individual buildings could also be shown in the GIS simply by clicking on the dot or symbol used to represent each building and selecting the desired image.

Maps Showing Seismicity Regions

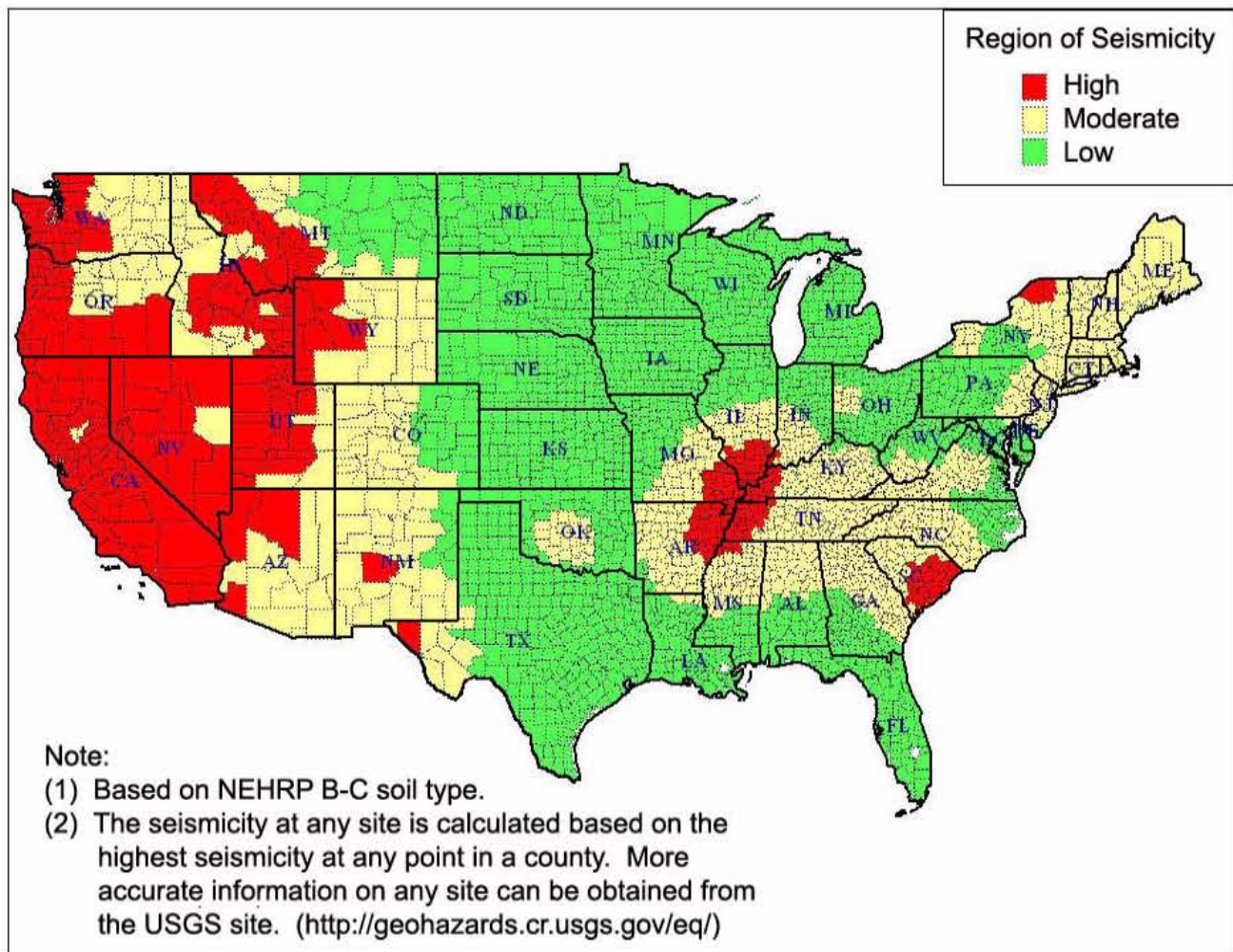

Figure A-1 Seismicity Regions of the Conterminous United States.

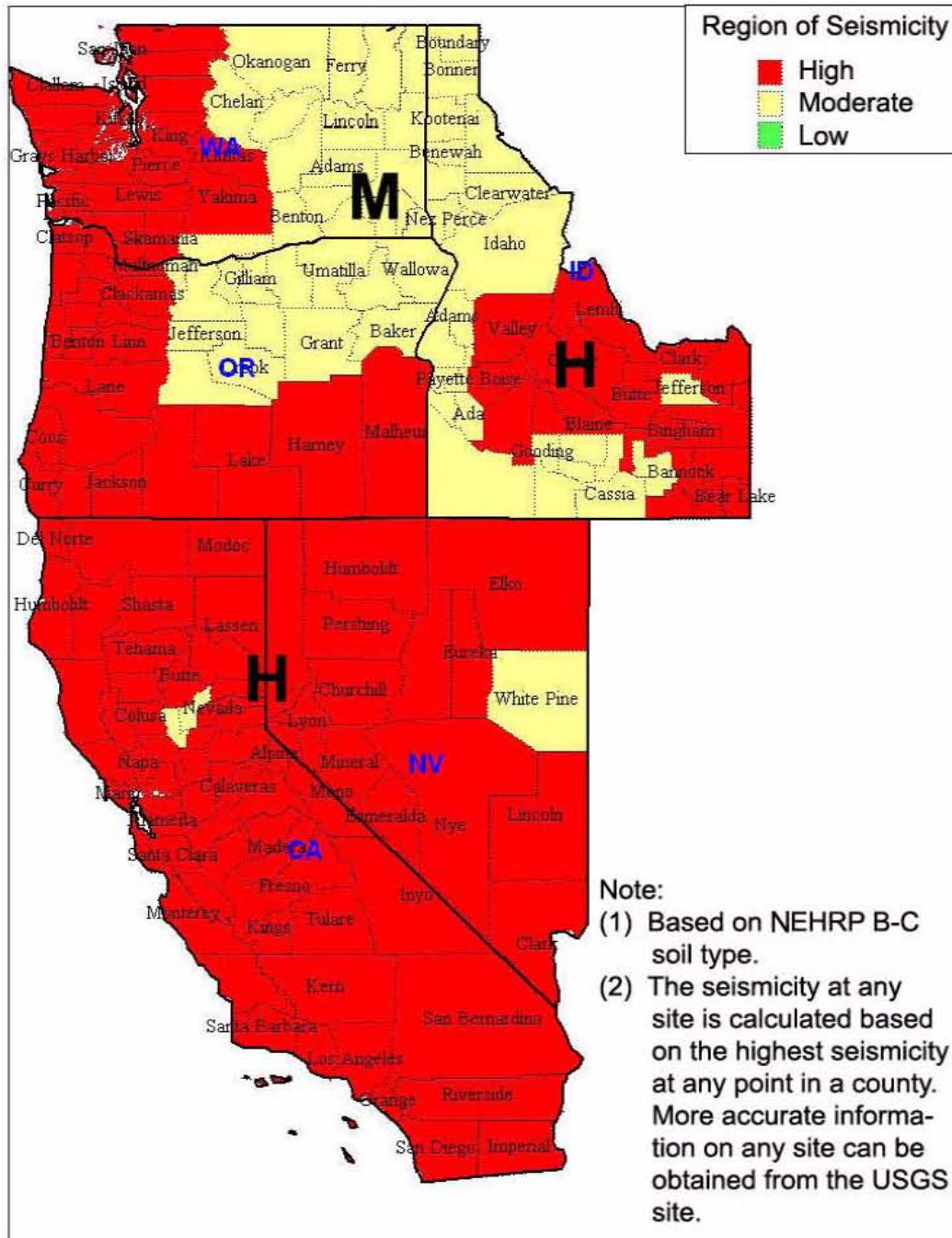

Figure A-2 Seismicity Regions in California, Idaho, Nevada, Oregon, and Washington.

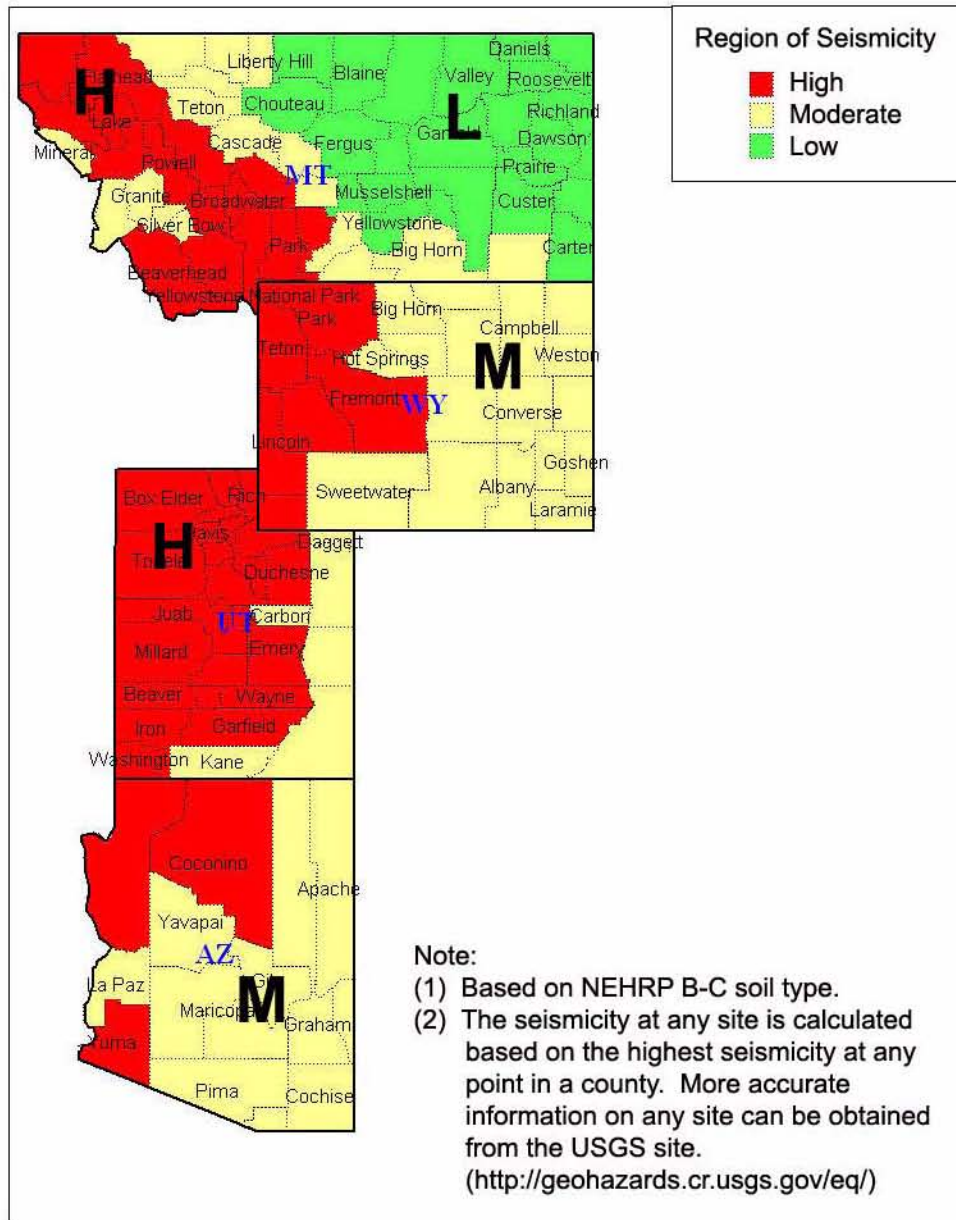

Figure A-3 Seismicity Regions in Arizona, Montana, Utah, and Wyoming.

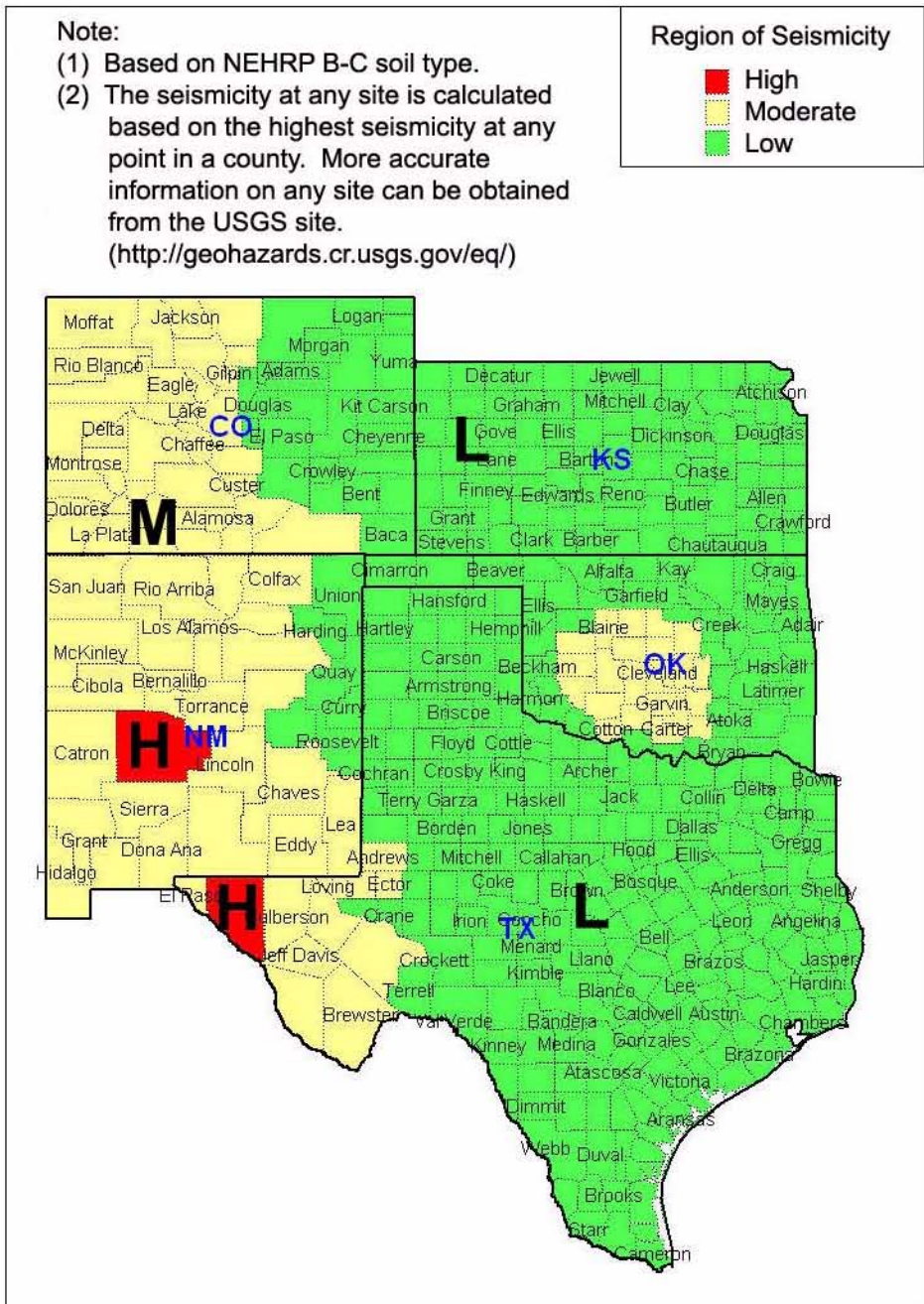

Figure A-4 Seismicity Regions in Colorado, Kansas, New Mexico, Oklahoma, and Texas.

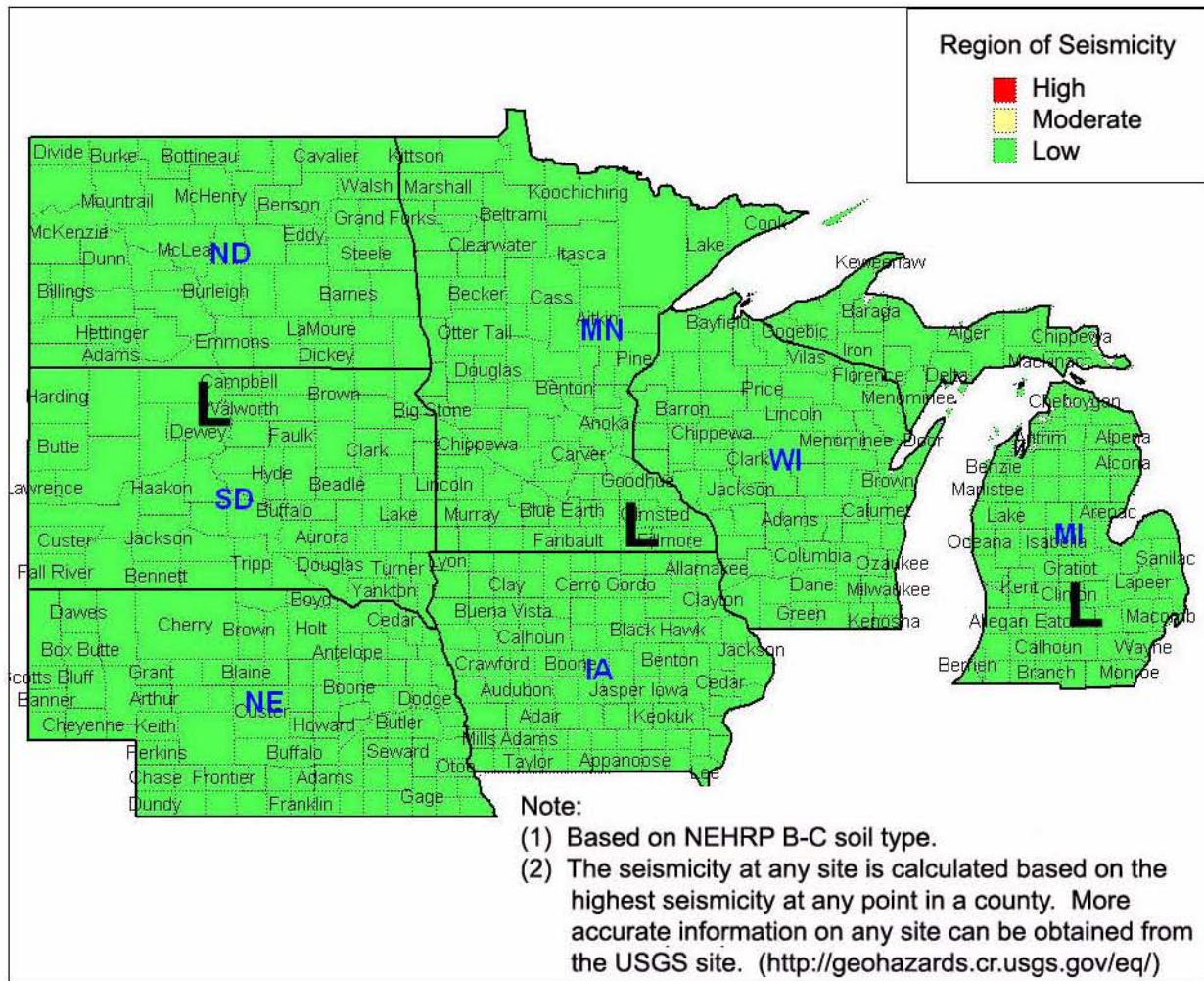

Figure A-5 Seismicity Regions in Iowa, Michigan, Minnesota, Nebraska, North Dakota, South Dakota, and Wisconsin.

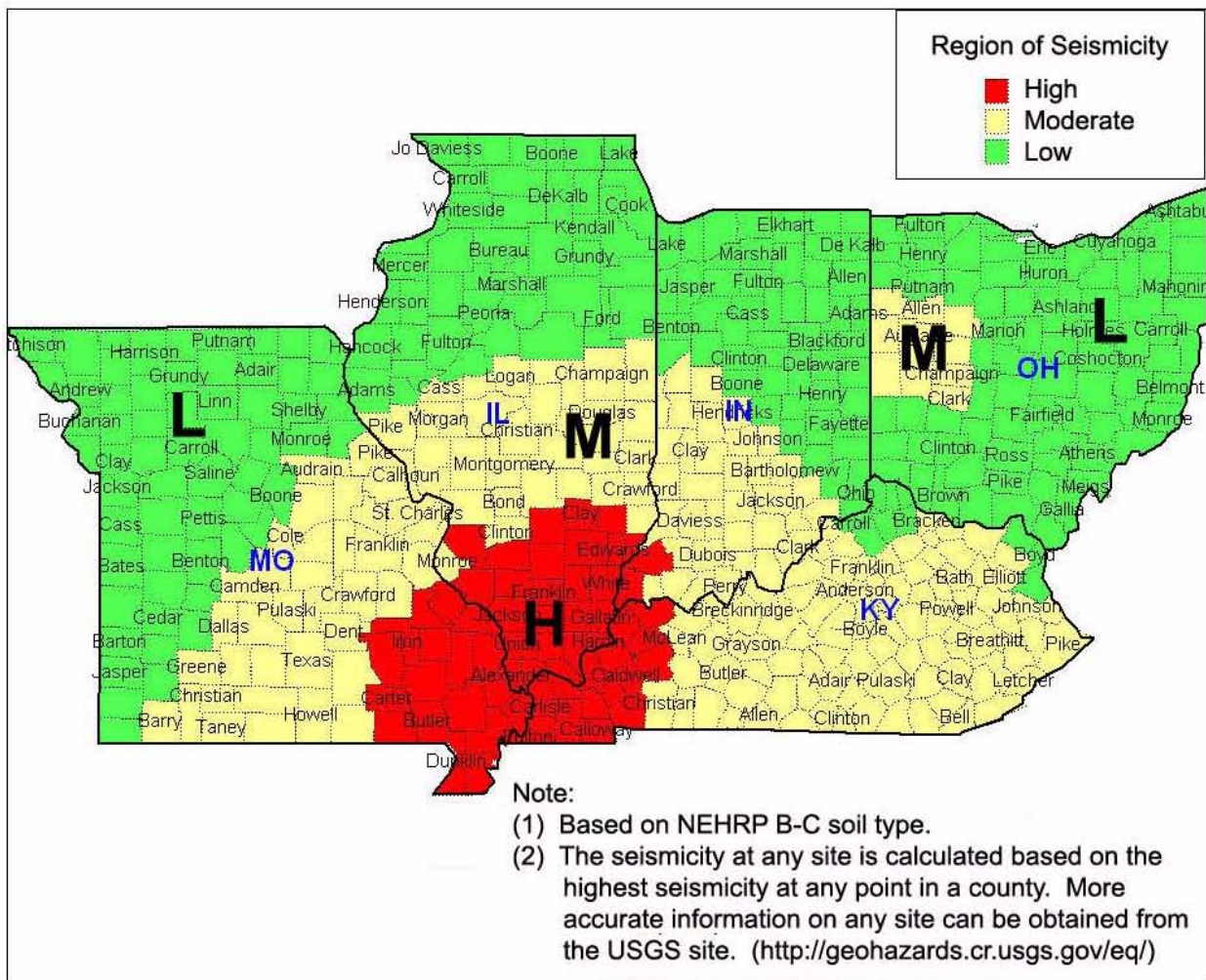

Figure A-6 Seismicity Regions in Illinois, Indiana, Kentucky, Missouri, and Ohio.

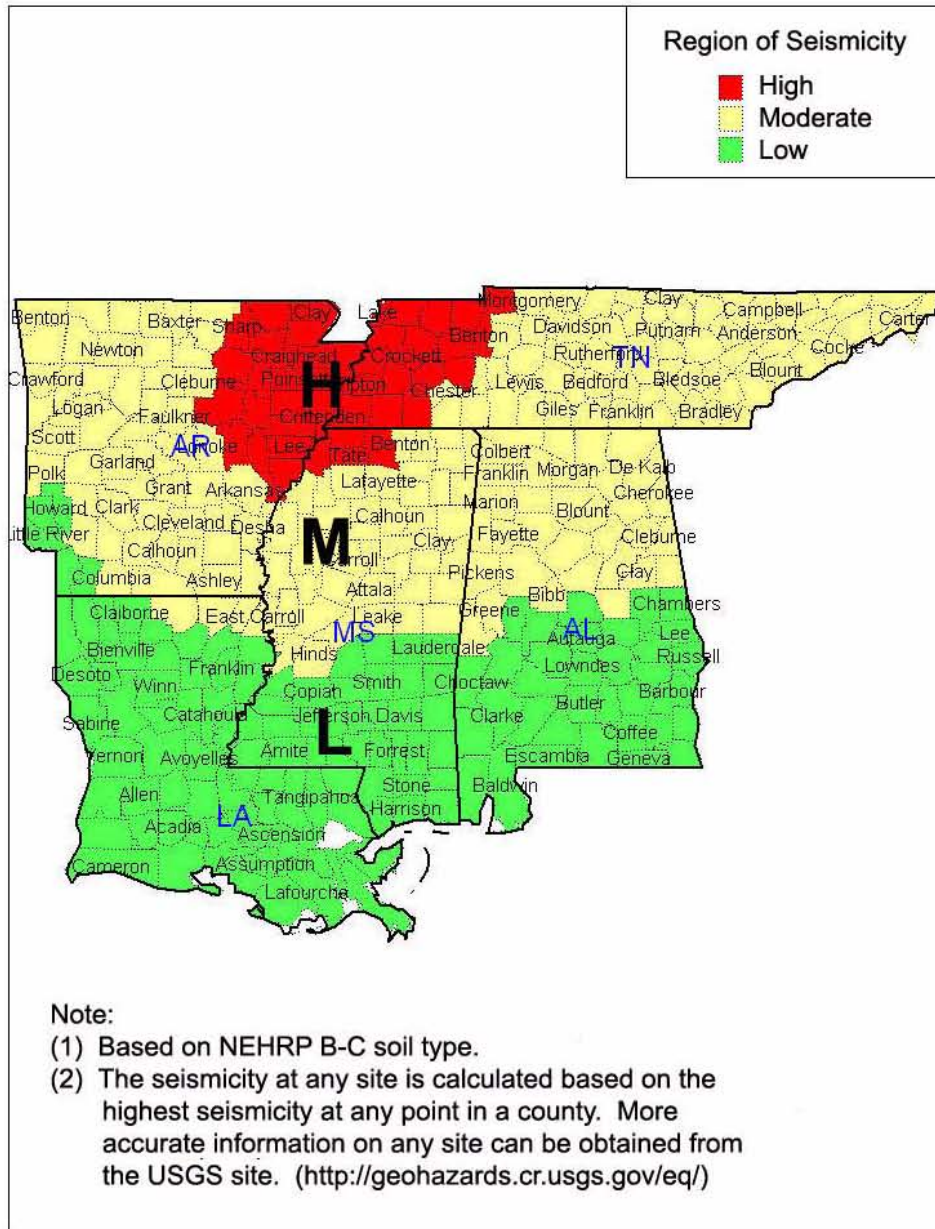

Figure A-7 Seismicity Regions in Alabama, Arkansas, Louisiana, Mississippi, and Tennessee.

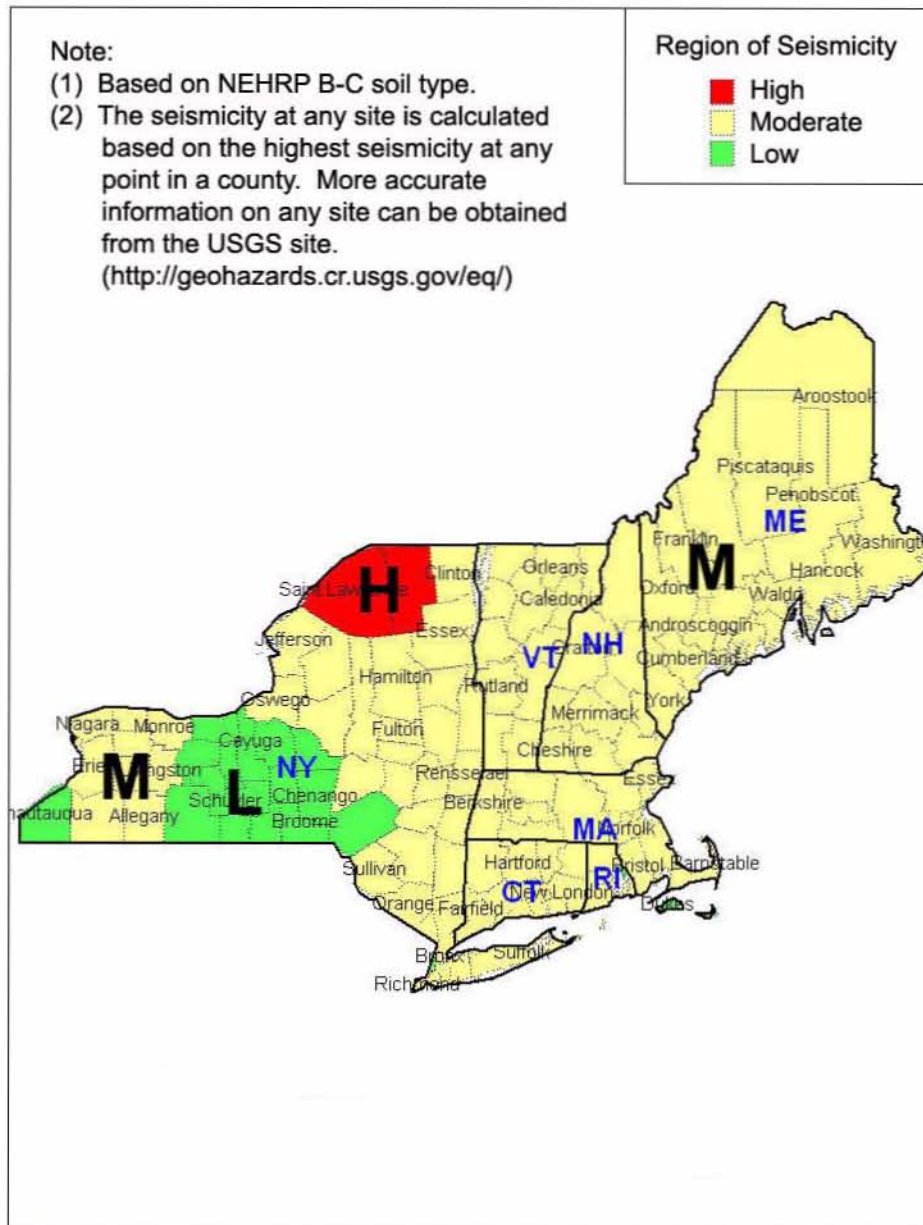

Figure A-8 Seismicity Regions in Connecticut, Maine, Massachusetts, New Hampshire, New York, Rhode Island, and Vermont.

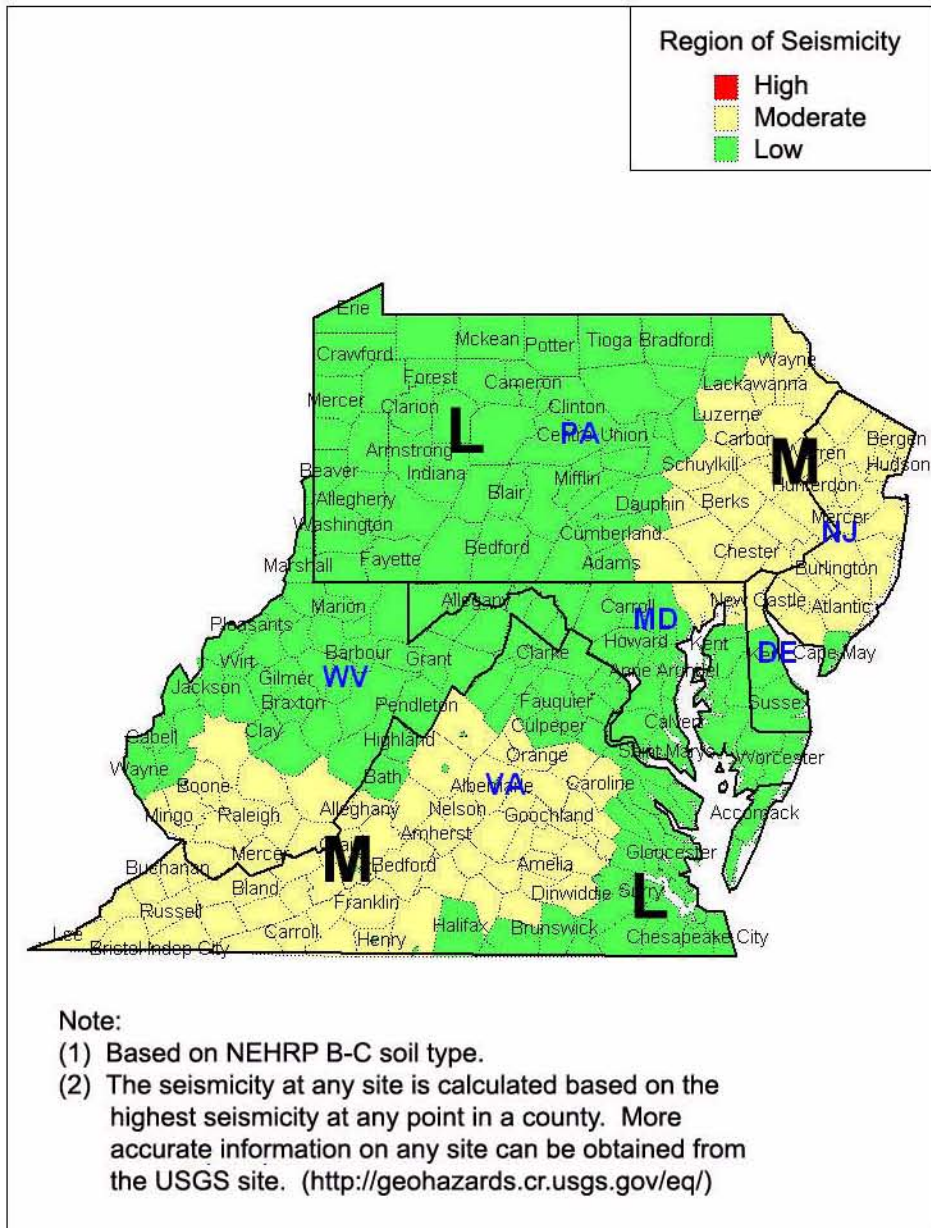

Figure A-9 Seismicity Regions in Delaware, Maryland, New Jersey, Pennsylvania, Virginia, and West Virginia.

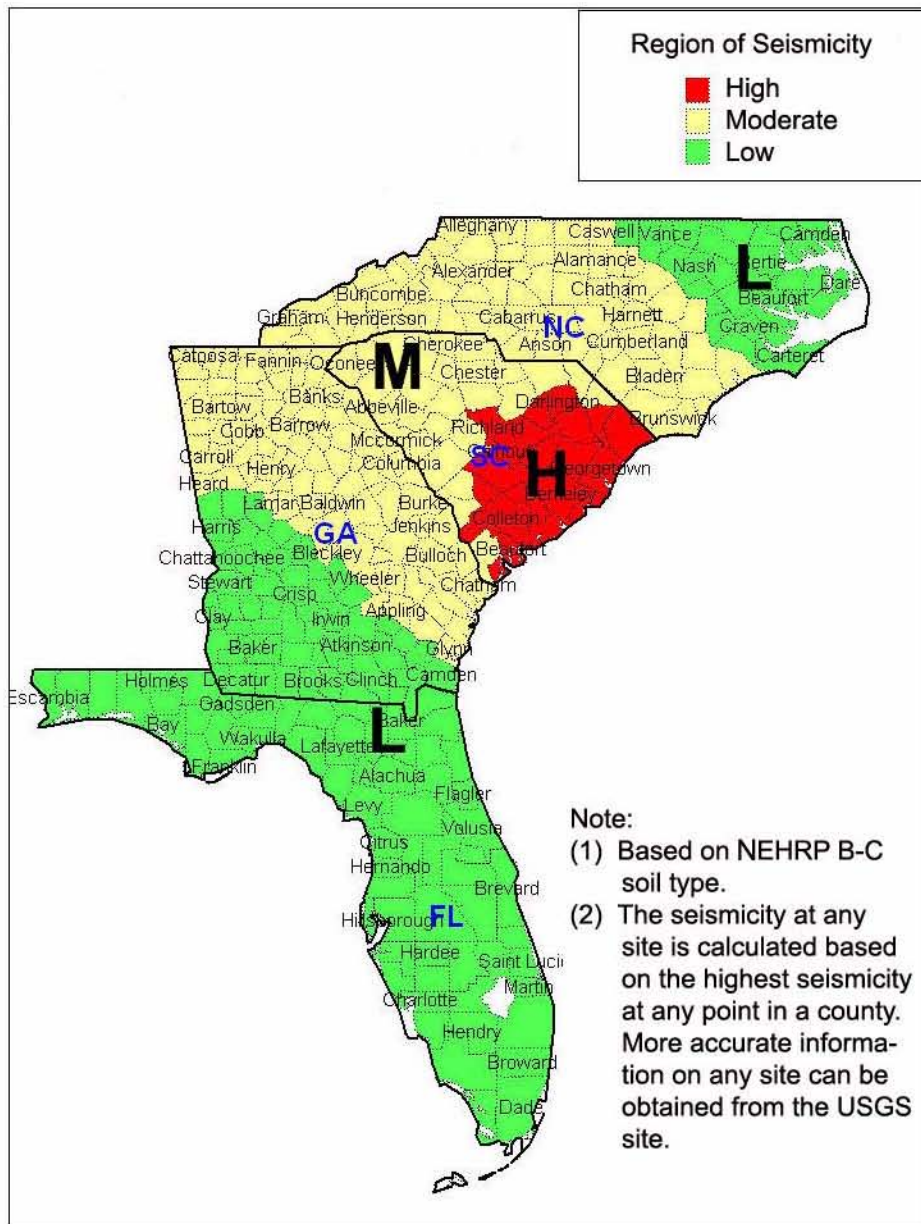

Figure A-10 Seismicity Regions in Florida, Georgia, North Carolina, and South Carolina.

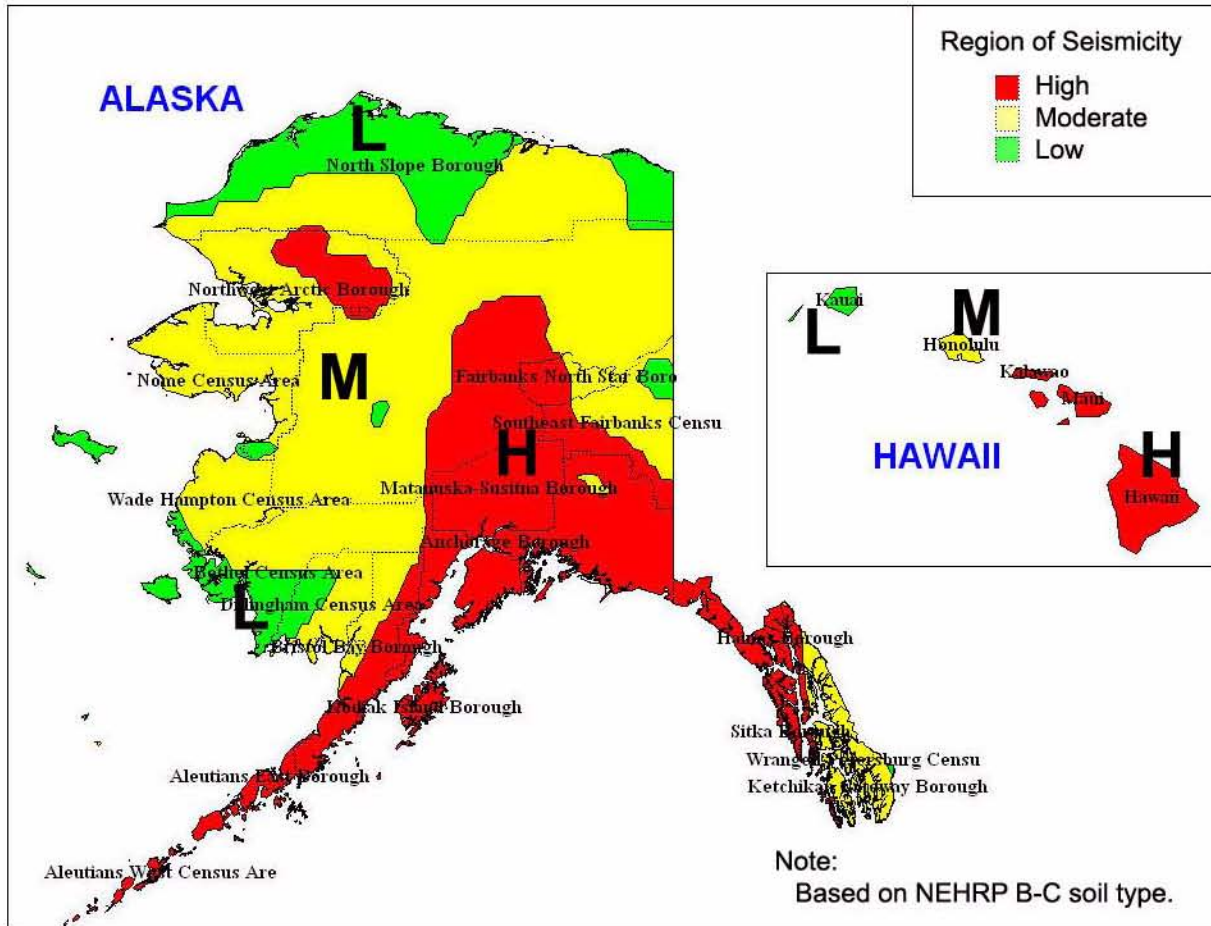

Figure A-11 Seismicity Regions in Alaska and Hawaii.

Data Collection Forms and Quick Reference Guide

Rapid Visual Screening of Buildings for Potential Seismic Hazards (FEMA 154)

Quick Reference Guide (for use with Data Collection Form)

1. Model Building Types and Critical Code Adoption and Enforcement Dates		Year Seismic Codes Initially Adopted and Enforced*	Benchmark Year when Codes Improved
Structural Types			
W1	Light wood frame, residential or commercial, ≤ 5000 square feet	_____	_____
W2	Wood frame buildings, > 5000 square feet.	_____	_____
S1	Steel moment-resisting frame	_____	_____
S2	Steel braced frame	_____	_____
S3	Light metal frame	_____	_____
S4	Steel frame with cast-in-place concrete shear walls	_____	_____
S5	Steel frame with unreinforced masonry infill	_____	_____
C1	Concrete moment-resisting frame	_____	_____
C2	Concrete shear wall	_____	_____
C3	Concrete frame with unreinforced masonry infill	_____	_____
PC1	Tilt-up construction	_____	_____
PC2	Precast concrete frame	_____	_____
RM1	Reinforced masonry with flexible floor and roof diaphragms	_____	_____
RM2	Reinforced masonry with rigid diaphragms	_____	_____
URM	Unreinforced masonry bearing-wall buildings	_____	_____
*Not applicable in regions of low seismicity			





2. Anchorage of Heavy Cladding
Year in which seismic anchorage requirements were adopted: _____

Use	Square Feet, Per Person	Use	Square Feet, Per Person
Assembly	varies, 10 minimum	Industrial	200-500
Commercial	50-200	Office	100-200
Emergency Services	100	Residential	100-300
Government	100-200	School	50-100

4. Score Modifier Definitions	
<i>Mid-Rise:</i>	4 to 7 stories
<i>High-Rise:</i>	8 or more stories
<i>Vertical Irregularity:</i>	Steps in elevation view; inclined walls; building on hill; soft story (e.g., house over garage); building with short columns; unbraced cripple walls.
<i>Plan Irregularity</i>	Buildings with re-entrant corners (L, T, U, E, + or other irregular building plan); buildings with good lateral resistance in one direction but not in the other direction; eccentric stiffness in plan, (e.g. corner building, or wedge-shaped building, with one or two solid walls and all other walls open).
<i>Pre-Code:</i>	Building designed and constructed prior to the year in which seismic codes were first adopted and enforced in the jurisdiction; use years specified above in Item 1; default is 1941, except for PC1, which is 1973.
<i>Post-Benchmark:</i>	Building designed and constructed after significant improvements in seismic code requirements (e.g., ductile detailing) were adopted and enforced; the benchmark year when codes improved may be different for each building type and jurisdiction; use years specified above in Item 1 (see Table 2-2 of FEMA 154 Handbook for additional information).
<i>Soil Type C:</i>	Soft rock or very dense soil; S-wave velocity: 1200 – 2500 ft/s; blow count > 50; or undrained shear strength > 2000 psf.
<i>Soil Type D:</i>	Stiff soil; S-wave velocity: 600 – 1200 ft/s; blow count: 15 – 50; or undrained shear strength: 1000 – 2000 psf.
<i>Soil Type E:</i>	Soft soil; S-wave velocity < 600 ft/s; or more than 100 ft of soil with plasticity index > 20, water content > 40%, and undrained shear strength < 500 psf.

Review of Design and Construction Drawings

Drawing styles vary among engineering offices, but the conventions used are very consistent. The following are some of the common designations:

1. Around the perimeter of the building, the exterior walls will be shown as a double line, if the space between the lines is empty, this will usually be a wood stud wall. 
2. Concrete walls will be shaded. 
3. Masonry walls will be cross hatched. 
4. Horizontal beams and girders will be shown with a solid line for steel and wood, and a double solid or dotted line for concrete.
 - Steel framing will have a notation of shape, depth, and weight of the member. The designations will include W, S, I, B and several others followed by the depth in inches, an “x,” and the weight in pounds per lineal foot. An example would be W8x10 (wide flange shape, 8” deep, 10 lbs/ft).
 - Wood framing will have the width and depth of the member. An example would be 4x10 (4” wide and 10” deep). Floor joists and roof rafters will be shown with the same call-out except not all members will be shown. A few at each end of the area being framed will show and there will be an arrow showing the extent and the call-out of the size members.
 - Concrete framing will have the width and depth. Where steel and wood are shown as single line, concrete will be shown as a double line. An example of the call out would be 12x24 (12” wide and 24” deep). Additionally, or in lieu of the number call-out, the member might be given a letter and number (B-1 or G-1) with a reference to a schedule for the size and reinforcing. “B” stands for beam and “G” stands for girder. Usually, beams are smaller than girders and span between girders while girders will be larger and frame between columns.
5. Columns will show on the floor plans as their shape with a shading designation where appropriate:
 - Steel column will be shown as an “H” rotated to the correct orientation for the location on the plan.
 - Wood column will be an open square. 
 - Concrete column will be either a square or a circle depending on the column configuration. The square or circle will be shaded. 
6. Steel moment frames will show the columns with a heavy line between the columns representing the beam or girder. At each end of the beam or girder at the column will be a small triangle shaded. This indicates that the connection between the beam or girder and the column is fully restrained.

Exterior Screening for Seismic System and Age

D.1 Introduction

A successful evaluation of a building is dependent on the screener's ability to identify accurately the construction materials, lateral-force-resisting system, age, and other attributes that would modify its earthquake performance (e.g., vertical or plan irregularities). This appendix includes discussions of inspection techniques that can be used while viewing from the street.

D.2 What to Look for and How to Find It

It may be difficult to identify positively the structural type from the street as building veneers often mask the structural skeleton. For example, a steel frame and a concrete frame may look similar from the outside. Features typical of a specific type of structure may give clues for successful identification. In some cases there may be more than one type of frame present in the structure. Should this be the case, the predominant frame type should be indicated on the form.

Following are attributes that should be considered when trying to determine a building lateral-force-resisting system from the street:

1. *Age*: The approximate age of a building can indicate the possible structure type, as well as indicating the seismic design code used during the building design process. Age is difficult to determine visually, but an approximation, accurate within perhaps a decade, can be estimated by looking at the architectural style and detail treatment of the building exterior, if the facade has not been renovated. If a building has been renovated, the apparent age is misleading. See Section D.3 for additional guidance.
2. *Facade Pattern*: The type of structure can sometimes be deduced by the openness of the facade, or the size and pattern of window openings. The facade material often can give hints to the structure beneath. Newer facade materials likely indicate that modern construction types were used in the design and may indicate that certain building types can be eliminated.

3. *Height*: The number of stories will indicate the possible type of construction. This is particularly useful for taller buildings, when combined with knowledge of local building practice. See Section D.4 for additional guidance.
4. *Original Use*: The original use can, at times, give hints as to the structural type. The original use can be inferred from the building character, if the building has not been renovated. The present use may be different from the original use. This is especially true in neighborhoods that have changed in character. A typical example of this is where a city's central business district has grown rapidly, and engulfed what were once industrial districts. The buildings' use has changed and they are now either mixed office, commercial or residential (for office workers).

D.3 Identification of Building Age

The ability to identify the age of a building by considering its architectural style and construction materials requires an extensive knowledge of architectural history and past construction practice. It is beyond the scope of this *Handbook* to discuss the various styles and construction practices. Persons involved in or interested in buildings often have a general knowledge of architectural history relevant to their region. Interested readers should refer to in-depth texts for more specific information.

Photographs, architectural character, and age of (1) residential, (2) commercial, and (3) mixed use and miscellaneous buildings, are illustrated in Tables D-1 through D-3, respectively. Photographs of several example steel frame and concrete frame buildings under construction are provided in Figure D-1. The screener should study these photographs and characteristics closely to assist in differentiating architectural styles and facade treatment of various periods. Facade renovation (see photos b and c in Figure D-1) can clearly alter the original appearance. When estimating building age, the screener should look at the building from all sides as facade renovation often occurs only at the building front. A new building will seldom look like an old one. That

Table D-1 Photographs, Architectural Characteristics, and Age of Residential Buildings

Examples

Characteristics



a. 1965-1980



b. 1965-1980



c. 1965-1980



d. 1960-1975 reinforced concrete shear wall



e. Pre-1933 URM (rehabilitated)

Low-Rise Buildings (1-3 stories):

- Typically wood or masonry
- May have ground floor or basement parking, a soft story
- Older buildings typically have more architectural detail, ornamentation
- 1950s and later are more 'modern' – lacking ornamentation, typically with more horizontal lines

Common structural types: W2, RM1, RM2, URM

Mid-Rise (4-7 stories) and High-Rise Buildings (8 stories and higher):

- Typically, reinforced concrete (older, URM)
- May have commercial ground floor, a soft story
- Older buildings typically have more cornices, architectural detail, ornamentation
- 1950s and later are lacking ornamentation, typically with stronger vertical or horizontal lines

Common structural types: W2, RM1, RM2, URM

Table D-2 Illustrations, Architectural Characteristics, and Age of Commercial Structures

Examples

Characteristics

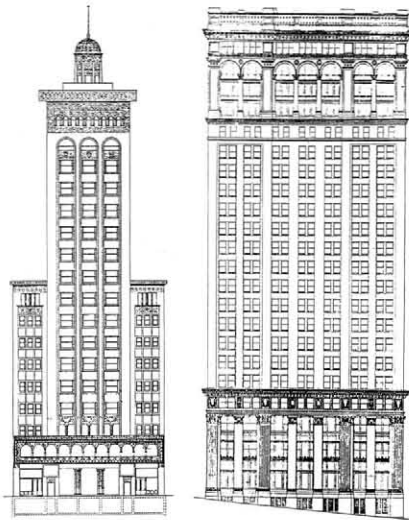

a. Pre-1930



Pre-1950

- Building has flat roof with cornices, or several set-backs.
- Ornate decorative work in concrete, terra cotta, cast stone or iron.
- Large bell tower or clock tower is common.
- Simple pattern of windows on all sides.
- Floors are concrete slabs on steel or concrete beams.
- Exterior is stone, terra cotta or concrete.

Common Structure Types: S2, S5, C2, C3



c. 1920-1930

b. 1910-1920
(Steel frame with unreinforced masonry infill that has been seismically rehabilitated)



d. 1920-1930



e. 1890-1900

Table D-2 Illustrations, Architectural Characteristics, and Age of Commercial Structures (Continued)

Examples

Characteristics



f. 44 story, 1960s, L-shape on the left; 20 story, 1914, with setback on the right



g. 1950-1975



i. 1950-1975



h. 1940-1950



j. 1950-1975

1950-1975

- Flat roof, typically with no cornice.
- Building is square or rectangular full height, fewer setbacks.
- First story and top story can be taller than other stories. In some cases the top story could be shorter than others.
- Exterior finishes metal or glass, pre-cast stone or concrete.
- Floors are concrete slab over steel or concrete beams.

Common Structure Types:
S1, S2, S4, C1, C2

Table D-2 Illustrations, Architectural Characteristics, and Age of Commercial Structures (Continued)

Examples

Characteristics



k. Post-1975



l. Post-1975



m. Post-1975



n. Post-1975



o. Post-1975

Post-1975

- Flat roof, typically with no cornice.
- Building is square or rectangular for its full height, fewer setbacks.
- First story and top story can be taller than other stories. (In some cases, though, the top story could be shorter than others.)
- Exterior finishes: metal or glass, pre-cast stone or concrete, with little ornamentation
- Floors are concrete slabs over steel or concrete beams.

Common Structure Types: S1, S2, S4, C1, C2

is, a building is usually at least as old as it looks. Even when designed to look old, telltale signs of modern techniques can usually be seen in the type of windows, fixtures, and material used.

D.4 Identification of Structural Type

The most common inspection that will be utilized with the RVS procedure will be the exterior or “sidewalk” or “streetside” survey. First, the evaluation should be as thorough as possible and performed in a

logical manner. The street-facing front of the building is the starting point and the evaluation begins at the ground and progressively moves up the exterior wall to the roof or parapet line. For taller buildings, a pair of binoculars is useful. When a thorough inspection of the street-front elevation has been completed, the procedure is repeated on the next accessible wall. From the exterior, the screener should be able to determine the approximate age of the building, its original occupancy, and count the number of stories.

Table D-3 Photographs, Architectural Characteristics, and Age of Miscellaneous Structures

Examples

Characteristics

Mixed use (residential with a commercial first floor), places of assembly, theatres, triangular buildings, halls, parking structures:

- Long spans
- Tall first story (for commercial use) – soft or weak story
- Atria or irregular floor-to-floor layout



a. 1920-1930



b. 1920-1950



c. 1990-2000



e. 1920-1930; windows create coupled shear walls.



f. Pre-1930



d. 1990-2000; airport terminal



g. 1950 – 1965 parking structure



h. 1920-1930; theater and shops complex, reinforced concrete



a. Building above is a high-rise steel dual system – moment frame (heavy columns and beams on upper facade) with bracing around elevator core. Fireproofing is being applied to steel at mid-height (inside the shroud) and precast facade elements are being attached to frame in lower stories.

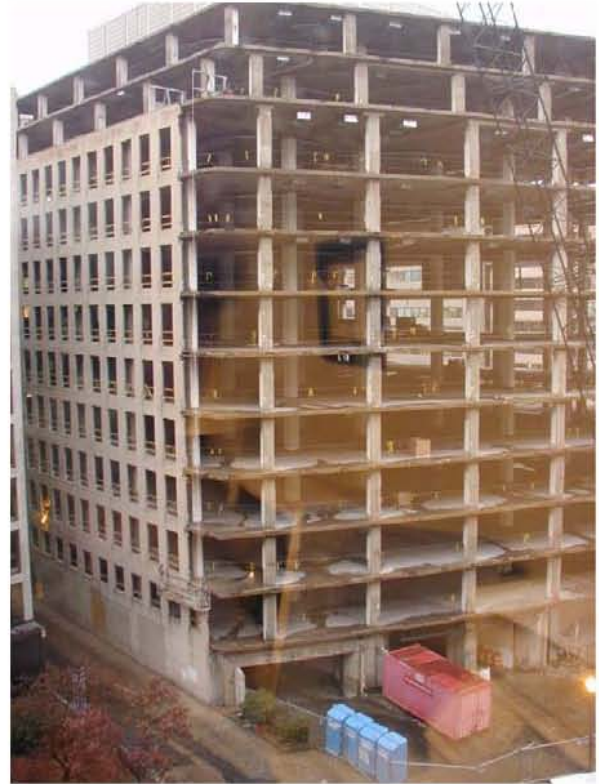

b. Reinforced concrete frame under renovation – demolition of older facade units.



c. New precast facade units being applied to reinforced concrete frame buildings.

Figure D-1 Photos showing basic construction, in steel-frame buildings and reinforced concrete-frame buildings.

With this information, Tables D-4 through D-7 provide the most likely structural system type, based on original occupancy and number of stories. (These tables are based on expert judgment and would benefit from verification by design professionals and

building regulatory personnel familiar with local design and construction practices.)

In addition to using information on occupancy and number of stories, as provided in Tables D-4 through D-7, the following are some locations that

Table D-4 Most Likely Structural Types for Pre-1930 Buildings

Original Occupancy	Number of Stories					
	1-2	3	4-6	7-15	15-30	30+
Residential	W	W	S5	S5		
	URM	URM	C3	C3		
Commercial	W	W	S1	S1	S1	
	S4	S4	S2	S2	S2	
	S5	S5	S4	S4	S4	
	C1	C1	S5	S5	S5	
	C2	C2	C1	C1	C1	
	C3	C3	C2	C2	C2	
	URM	URM	C3	C3	C3	
			URM			
Industrial	W	W				
	S1	S1				
	S2	S2				
	S3	S5				
	S5	C1				
	C1	C2				
	C2	C3				
	C3	URM				
URM						

Note: If it is not possible to identify immediately the structural type for a pre-1930 building, the original occupancy and number of stories will provide some guidance. The building will need further inspection for precise identification.

Table D-5 Most Likely Structural Types for 1930-1945 Buildings

Original Occupancy	Number of Stories					
	1-2	3	4-6	7-15	15-30	30+
Residential	W	W	S1	S1		
	URM	URM	S2	S2		
			S5	S5		
			URM			
Commercial	W	W	S1	S1	S1	S2
	S1	S1	S2	S2	S2	S5
	S2	S2	S5	S5	S5	
	S5	S5	C1	C1	C1	
	C1	C1	C2	C2	C2	
	C2	C2	C3	C3	C3	
	C3	C3	RM1			
	RM1	RM1	RM2			
	RM2	RM2	URM			
	URM	URM				
Industrial	S3	S3	C1			
	S5	S5	C2			
	C1	C1	C3			
	C2	C2				
	C3	C3				
	RM1	RM1				
	RM2	RM2				
	URM	URM				

Note: If it is not possible to identify immediately the structural type for a 1930-1945 building, the original occupancy and number of stories will provide some guidance. The building will need further inspection for precise identification.

Table D-6 Most Likely Structural Types for 1945-1960 Buildings

Original Occupancy	Number of Stories					
	1-2	3	4-6	7-15	15-30	30+
Residential	W	W	S1	S1	S1	S1
	RM	RM	S2	S2	S2	S2
	URM*	URM*	C1	C1	C1	C1
			C2	C2	C2	C2
			RM1,2			
		URM*				
Commercial	W	W	S1	S1	S1	S1
	S1	S1	S2	S2	S2	S2
	S2	S2	C1	C1	C1	C1
	C1	C1	C2	C2	C2	C2
	C2	C2	RM1			
	RM1,2	RM1,2	RM2			
	URM*	URM*	URM*			
Industrial	C1	S1	S1			
	C2	S2	S2			
	PC1	C1	C1			
	RM1	C2	C2			
	RM2	RM1,2	RM1,2			
	URM*	URM*	URM*			

Notes: If it is not possible to identify immediately the structural type for a 1945-1960 building, the original occupancy and number of stories will provide some guidance. The building will need further inspection for precise identification.

*By this period, URM was generally not permitted in California or other high-seismicity locations, so that only in the central or eastern U.S. would buildings of this age be URM.

Table D-7 Most Likely Structural Types for Post-1960 Buildings

Original Occupancy	Number of Stories					
	1-2	3	4-6	7-15	15-30	30+
Residential	W	W	W	S1		
	S1	S1	S1	S2		
	S2	S2	S2	C1		
	C1	C1	C1	C2		
	C2	C2	C2	PC2		
	PC2	PC2	PC2	RM1		
	RM1,2	RM1,2	RM1,2	RM2		
Commercial	W	W	W	S1	S1	S1
	S1	S1	S1	S2	S2	S2
	S2	S2	S2	C1	C1	C1
	C1	C1	C1	C2	C2	C2
	C2	C2	C2	PC2	PC2	
	PC1	PC1	PC2	RM1		
	PC2	PC2	RM1	RM2		
	RM1,2	RM1,2	RM2			
Industrial	S1	S1	S1	S1	C1	
	S2	S2	S2	S2	C2	
	S3	C1	C1	C1	PC2	
	C1	C2	C2	C2		
	C2	PC1	PC2	PC2		
	PC1	PC2	RM1			
	PC2	RM1	RM2			
	RM1,2	RM2				

Note: If it is not possible to identify immediately the structural type for a post-1960 building, the original occupancy and number of stories will provide some guidance. The building will need further inspection for precise identification.

the screener can look, without performing destructive investigations, to gain insight into the structure type:

1. In newer frame construction the columns are often exposed on the exterior in the first story. If the columns are covered with a facade material, they are most likely steel columns, indicating a steel frame. If the frames are concrete, they are usually exposed and not covered with a facade. See Figures D-2 and D-3.
2. Some structures use a combination of shear walls in the transverse direction and frames in the longitudinal direction. This can be seen from the exterior as the shear walls usually extend through the exterior longitudinal wall and are exposed there. This is most common in hotels and other residential structures where balconies are included. See Figure D-4.
3. An inspection of doorways and window framing can determine wall thickness. When the thickness exceeds approximately 12 inches, the wall is most likely unreinforced masonry (URM).



Figure D-2 Building with exterior columns covered with a facade material.

4. If there are vertical joints in the wall, regularly spaced and extending to the full height, the wall is constructed of concrete, and if three or less stories in height, the structure type is most likely a tilt-up (PC1). See Figure D-5.
5. If the building is constructed of brick masonry without header courses (horizontal rows of visible brick ends), and the wall thickness is approx-



Figure D-3 Detail of the column facade of Figure D-2.



Figure D-4 Building with both shear walls (in the short direction) and frames (in the long direction).

imately 8 inches, the structural type is most likely reinforced masonry (RM1 or RM2). See Figure D-6.

6. If the exterior wall shows large concrete block units (approximately 8 to 12 inches high and 12 to 16 inches in length), either smooth or rough faced, the structure type may be reinforced concrete block masonry. See Figure D-7.

Because many buildings have been renovated, the screener should know where to look for clues to the original construction. Most renovations are done for commercial retail spaces, as businesses like to have an up-to-date image. Most exterior renovations are only to the front of the building or to walls that attract attention. Therefore, the original construction



Figure D-5 Regular, full-height joints in a building's wall indicate a concrete tilt-up.



Figure D-6 Reinforced masonry wall showing no course of header bricks (a row of visible brick ends).

can often be seen at the sides, or the rear, where people generally do not look. If the original material is covered in these areas, it is often just painted or lightly plastered. In this case, the pattern of the older material can often still be seen.

Clues helping identify the original material are apparent if one is looking for them. Two examples are included here:

- Figure D-8 shows a building with a 1970s polished stone and glass facade. The side of the building indicates that it is a pre-1930 URM bearing-wall structure.
- Figure D-9 shows a building facade with typical 1960s material. The side was painted. Showing through the paint, the horizontal board patterns in the poured-in-place concrete wall of pre-1940 construction could still be seen.



Figure D-7 Reinforced masonry building with exterior wall of concrete masonry units, or concrete blocks.



Figure D-8 A 1970s renovated facade hides a URM bearing-wall structure.

D.5 Characteristics of Exposed Construction Materials

Accurate identification of the structural type often depends on the ability to recognize the exposed construction material. The screener should be familiar



Figure D-9 A concrete shear-wall structure with a 1960s renovated facade.

with how different materials look on existing buildings as well as how they have been installed. Brief descriptions of some common materials are included here:

- *Unreinforced Masonry*—Unreinforced masonry walls, when they are not veneers, are typically several wythes thick (a wythe is a term denoting the width of one brick). Therefore, header bricks will be apparent in the exposed surface. Headers are bricks laid with the butt end on the exterior face, and function to tie wythes of bricks together. Header courses typically occur every six or seven courses. (See Figures D-10 and D-11.) Sometimes, URM infill walls will not have header bricks, and the wythes of brick are held together only by mortar. Needless to say, URM will look old, and most of the time show wear and weathering. URM may also have a soft sand-lime mortar which may be detected by scratching with a knife, unless the masonry has been repointed.



Figure D-10 URM wall showing header courses (identified by arrows) and two washer plates indicating wall anchors.

- *Reinforced Masonry*—Most reinforced brick walls are constructed using the hollow grout method. Two wythes of bricks are laid with a hollow space in between. This space contains the reinforcement steel and is grouted afterward (see Figure D-12). This method of construction usually does not include header bricks in the wall surface.
- *Masonry Veneer*—Masonry veneers can be of several types, including prefabricated panels, thin brick texture tiles, and a single wythe of brick applied onto the structural backing. Figures D-13 shows brick veneer panels. Note the discontinuity of the brick pattern interrupted by the vertical gaps. This indicates that the surface is probably a veneer panel. The scupper opening at the top of the wall, probably to let the rainwater on the roof to drain, also indicates that this is a thin veneer rather than a solid masonry

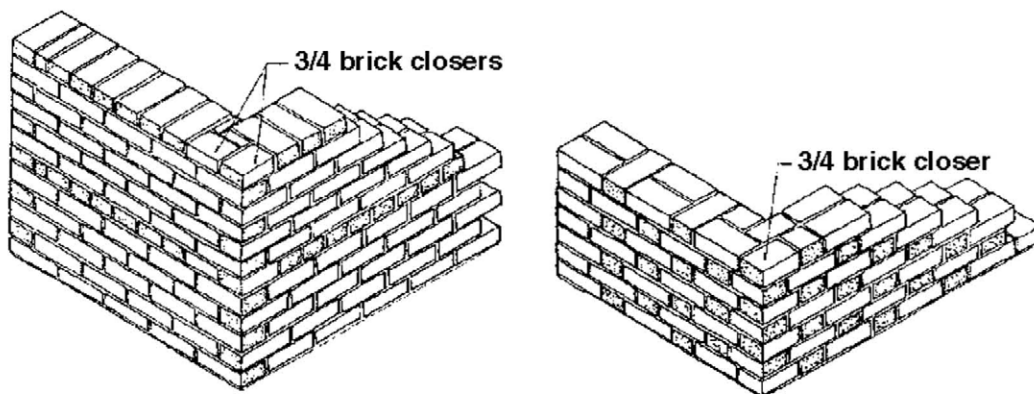

Figure D-11 Drawing of two types of masonry pattern showing header bricks (shown with stipples).

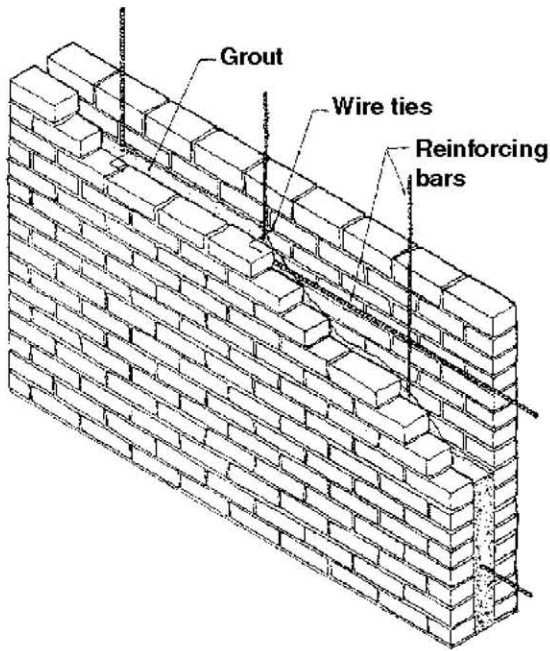

Figure D-12 Diagram of common reinforced masonry construction. Bricks are left out of the bottom course at intervals to create cleanout holes, then inserted before grouting.



Figure D-14 Hollow clay tile wall with punctured tile.

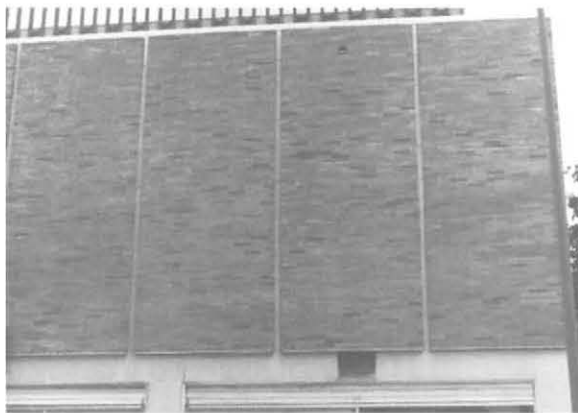

Figure D-13 Brick veneer panels.

wall. Good places to look for the evidence of veneer tile are at door or window openings where the edge of the tile will usually show.

- *Hollow Clay Tile*—The exposed area of a hollow clay tile masonry unit is approximately 6 inches by 10 inches and often has strip indentations running the length of the tile. They are fragile, unreinforced, and without structural value, and usually are used for non-load-bearing walls.

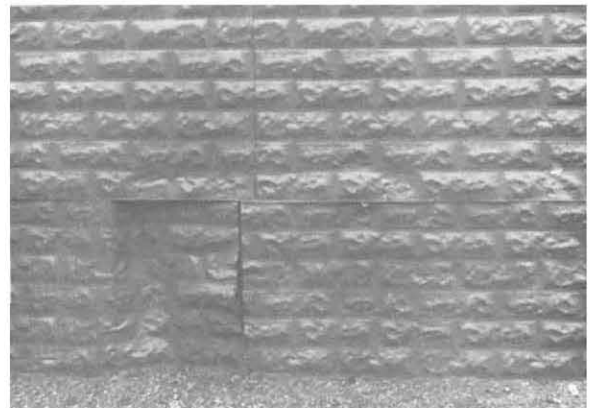

Figure D-15 Sheet metal siding with masonry pattern.

Figure D-14 shows a typical wall panel which has been punctured.

- *False Masonry*—Masonry pattern sidings can be made from sheet metal, plastic, or asphalt material (see Figures D-15 and D-16). These sidings come in sheets and are attached to a structural backing, usually a wood frame. These sidings can be detected by looking at the edges and by their sound when tapped.
- *Cast-in-Place Concrete*—Cast-in-place concrete, before the 1940s, will likely show horizontal patterns from the wooden formwork. The formwork was constructed with wood planks, and therefore the concrete also will often show the wood grain pattern. Since the plank edges were not smooth,

the surface will have horizontal lines approximately 4, 6, 8, 10, or 12 inches apart (see Figure D-17). Newer cast-in-place concrete comes in various finishes. The most economic finish is that in which the concrete is cast against plywood formwork, which will reflect the wood grain appearance of plywood, or against metal or plastic-covered wood forms, which normally do not show a distinctive pattern.



Figure D-16 Asphalt siding with brick pattern.

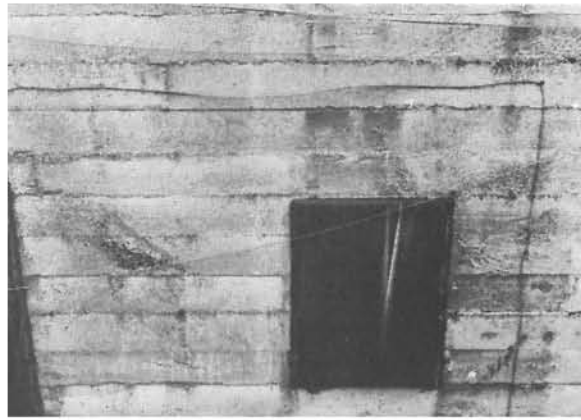

Figure D-17 Pre-1940 cast-in-place concrete with formwork pattern.

Appendix E

Characteristics and Earthquake Performance of RVS Building Types

E.1 Introduction

For the purpose of the RVS, building structural framing types have been categorized into fifteen types listed in Section 3.7.1 and shown in Table 3-1. This appendix provides additional information about each of these structural types, including detailed descriptions of their characteristics, common types of earthquake damage, and common seismic rehabilitation techniques.

E.2 Wood Frame (W1, W2)

E.2.1 Characteristics

Wood frame structures are usually detached residential dwellings, small apartments, commercial buildings or one-story industrial structures. They are rarely more than three stories tall, although older buildings may be as high as six stories, in rare instances. (See Figures E-1 and E-2)



Figure E-1 Single family residence (an example of the W1 identifier, light wood-frame residential and commercial buildings less than 5000 square feet).

Wood stud walls are typically constructed of 2-inch by 4-inch wood members vertically set about 16 inches apart. (See Figures E-3 and E-4). These walls are braced by plywood or equivalent material, or by diagonals made of wood or steel. Many detached single family and low-rise multiple family residences in the United States are of stud wall wood frame construction.



Figure E-2 Larger wood-framed structure, typically with room-width spans (W2, light, wood-frame buildings greater than 5000 square feet).

Post and beam construction, which consists of larger rectangular (6 inch by 6 inch and larger) or sometimes round wood columns framed together with large wood beams or trusses, is not common and is found mostly in older buildings. These buildings usually are not residential, but are larger buildings such as warehouses, churches and theaters.

Timber pole buildings (Figures E-5 and E-6) are a less common form of construction found mostly in suburban and rural areas. Generally adequate seismically when first built, they are more often subject to wood deterioration due to the exposure of the columns, particularly near the ground surface. Together with an often-found “soft story” in this building type, this deterioration may contribute to unsatisfactory seismic performance.

In the western United States, it can be assumed that all single detached residential houses (i.e., houses with rear and sides separate from adjacent structures) are wood stud frame structures unless visual or supplemental information indicates otherwise (in the Southwestern U.S., for example, some residential homes are constructed of adobe, rammed earth, and other non-wood materials). Many houses that appear to have brick exterior facades are actually wood frame with nonstructural brick veneer or brick-patterned synthetic siding.

In the central and eastern United States, brick walls are usually not veneer. For these houses the

Roof and span systems:

1. wood joist and rafter
2. diagonal sheathing
3. straight sheathing

Wall systems:

4. stud wall (platform or balloon framed)
5. horizontal siding

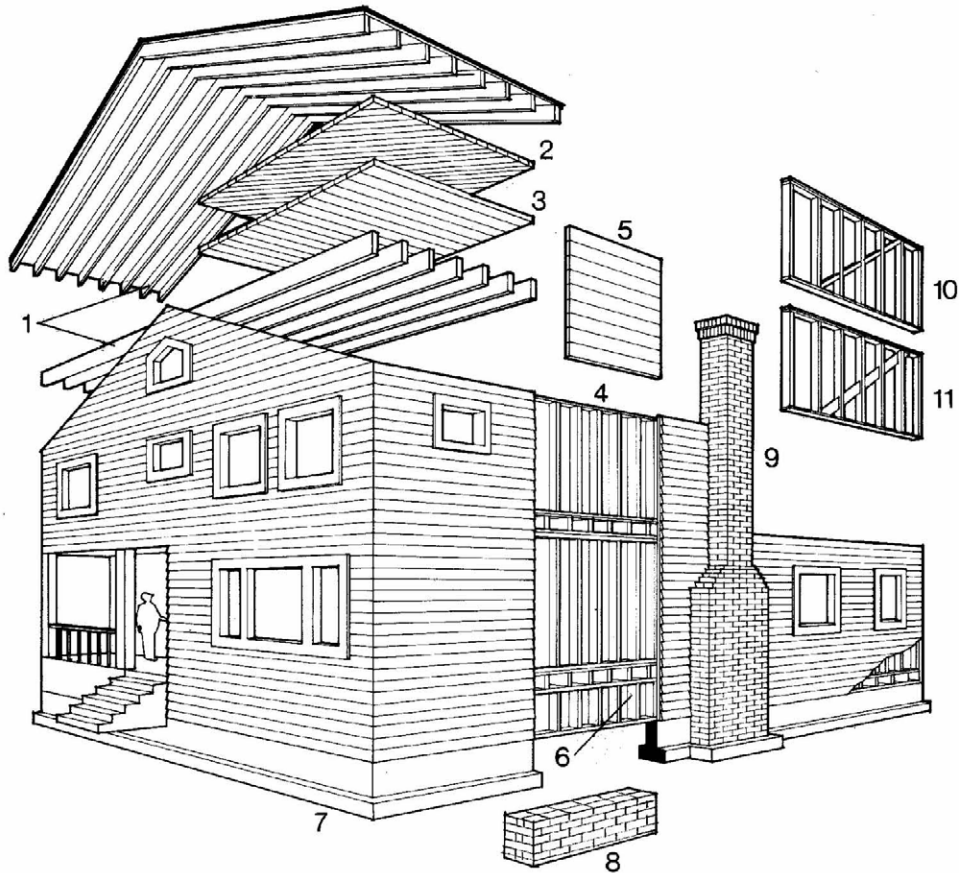

Foundations and connections:

6. unbraced cripple wall
7. concrete foundation
8. brick foundation

Bracing and details:

9. unreinforced brick chimney
10. diagonal blocking
11. let-in brace (only in later years)

Figure E-3 Drawing of wood stud frame construction.

brick-work must be examined closely to verify that it is real brick. Second, the thickness of the exterior wall is estimated by looking at a window or door opening. If the wall is more than 9 inches from the interior finish to exterior surface, then it may be a brick wall. Third, if header bricks exist in the brick pattern, then it may be a brick wall. If these features all point to a brick wall, the house can be assumed to be a masonry building, and not a wood frame.

In wetter, humid climates it is common to find homes raised four feet or more above the outside grade with this space totally exposed (no foundation walls). This allows air flow under the house, to mini-

mize decay and rot problems associated with high humidity and enclosed spaces. These houses are supported on wood post and small precast concrete pads or piers. A common name for this construction is post and pier construction.

E.2.2 Typical Earthquake Damage

Stud wall buildings have performed well in past earthquakes due to inherent qualities of the structural system and because they are lightweight and low-rise. Cracks in any plaster or stucco may appear, but these seldom degrade the strength of the building and are classified as nonstructural damage. In fact, this



Figure E-4 Stud wall, wood-framed house.

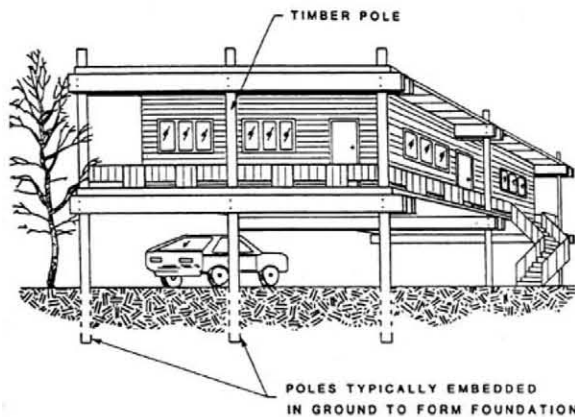

Figure E-5 Drawing of timber pole framed house.



Figure E-6 Timber pole framed house.

type of damage helps dissipate the earthquake-induced energy of the shaking house. The most common type of structural damage in older buildings results from a lack of adequate connection between the house and the foundation. Houses can slide off their foundations if they are not properly bolted to the foundations. This movement (see Figure E-7) results in major damage to the building as well as to plumbing and electrical connections. Overturning of



Figure E-7 House off its foundation, 1983 Coalinga earthquake.

the entire structure is usually not a problem because of the low-rise geometry. In many municipalities, modern codes require wood structures to be adequately bolted to their foundations. However, the year that this practice was adopted will differ from community to community and should be checked.

Many of the older wood stud frame buildings have no foundations or have weak foundations of unreinforced masonry or poorly reinforced concrete. These foundations have poor shear resistance to horizontal seismic forces and can fail.

Another problem in older buildings is the stability of cripple walls. Cripple walls are short stud walls between the foundation and the first floor level. Often these have no bracing neither in-plane nor out-of-plane and thus may collapse when subjected to horizontal earthquake loading. If the cripple walls collapse, the house will sustain considerable damage and may collapse. In some older homes, plywood sheathing nailed to the cripple studs may have been used to rehabilitate the cripple walls. However, if the sheathing is not nailed adequately to the studs and



Figure E-8 Failed cripple stud wall, 1992 Big Bear earthquake.

foundation sill plate, the cripple walls will still collapse (see Figure E-8).

Homes with post and pier perimeter foundations, which are constructed to provide adequate air flow under the structure to minimize the potential for decay, have little resistance to earthquake forces. When these buildings are subjected to strong earthquake ground motions, the posts may rotate or slip of the piers and the home will settle to the ground. As with collapsed cripple walls, this can be very expensive damage to repair and will result in the home building “red-tagged” per the ATC-20 post-earthquake safety evaluation procedures (ATC, 1989, 1995). See Figure E-9.



Figure E-9 Failure of post and pier foundation, Humboldt County.

Garages often have a large door opening in the front wall with little or no bracing in the remainder of the wall. This wall has almost no resistance to lateral forces, which is a problem if a heavy load such as a second story is built on top of the garage. Homes

built over garages have sustained damage in past earthquakes, with many collapses. Therefore the house-over-garage configuration, which is found commonly in low-rise apartment complexes and some newer suburban detached dwellings, should be examined more carefully and perhaps rehabilitated.

Unreinforced masonry chimneys present a life-safety problem. They are often inadequately tied to the house, and therefore fall when strongly shaken. On the other hand, chimneys of reinforced masonry generally perform well.

Some wood-frame structures, especially older buildings in the eastern United States, have masonry veneers that may represent another hazard. The veneer usually consists of one wythe of brick (a wythe is a term denoting the width of one brick) attached to the stud wall. In older buildings, the veneer is either insufficiently attached or has poor quality mortar, which often results in peeling of the veneer during moderate and large earthquakes.

Post and beam buildings (not buildings with post and pier foundations) tend to perform well in earthquakes, if adequately braced. However, walls often do not have sufficient bracing to resist horizontal motion and thus they may deform excessively.

E.2.3 Common Rehabilitation Techniques

In recent years, especially as a result of the Northridge earthquake, emphasis has been placed on addressing the common problems associated with light-wood framing. This work has concentrated mainly in the western United States with single-family residences.

The rehabilitation techniques focus on houses with continuous perimeter foundations and cripple walls. The rehabilitation work consists of bolting the house to the foundation and providing plywood or other wood sheathing materials to the cripple walls to strengthen them (see Figure E-10). This is the most cost-effective rehabilitation work that can be done on a single-family residence.

Little work has been done in rehabilitating timber pole buildings or post and pier construction. In timber pole buildings rehabilitation techniques are focused on providing resistance to lateral forces by bracing (applying sheathing) to interior walls, creating a continuous load path to the ground. For homes with post and pier perimeter foundations, the work has focused on providing partial foundations and bracing to carry the earthquake loads.



Figure E-10 Seismic strengthening of a cripple wall, with plywood sheathing.

E.3 Steel Frames (S1, S2)

E.3.1 Characteristics

Steel frame buildings generally may be classified as either moment-resisting frames or braced frames,

based on their lateral-force-resisting systems. Moment-resisting frames resist lateral loads and deformations by the bending stiffness of the beams and columns (there is no diagonal bracing). In concentric braced frames the diagonal braces are connected, at each end, to the joints where beams and columns meet. The lateral forces or loads are resisted by the tensile and compressive strength of the bracing. In eccentric braced frames, the bracing is slightly offset from the main beam-to-column connections, and the short section of beam is expected to deform significantly in bending under major seismic forces, thereby dissipating a considerable portion of the energy of the vibrating building. Each type of steel frame is discussed below.

Moment-Resisting Steel Frame

Typical steel moment-resisting frame structures usually have similar bay widths in both the transverse and longitudinal direction, around 20-30 ft (Figure E-11). The load-bearing frame consists of beams and columns distributed throughout the building. The floor diaphragms are usually concrete,

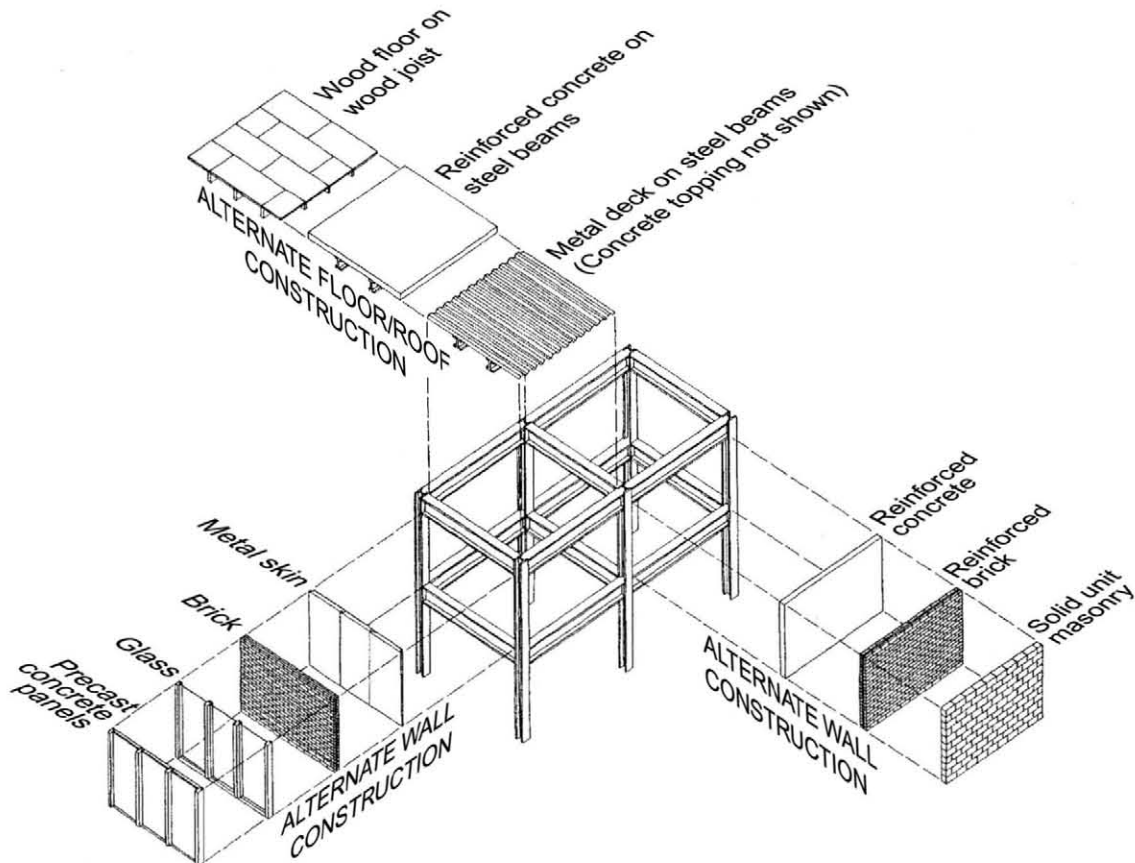

Figure E-11 Drawing of steel moment-resisting frame building.

sometimes over steel decking. Moment-resisting frame structures built since 1950 often incorporate prefabricated panels hung onto the structural frame as the exterior finish. These panels may be precast concrete, stone or masonry veneer, metal, glass or plastic.

This structural type is used for commercial, institutional and other public buildings. It is seldom used for low-rise residential buildings.

Steel frame structures built before 1945 are usually clad or infilled with unreinforced masonry such as bricks, hollow clay tiles and terra cotta tiles and therefore should be classified as S5 structures (see Section E.6 for a detailed discussion). Other frame buildings of this period are encased in concrete. Wood or concrete floor diaphragms are common for these older buildings.

Braced Steel Frame

Braced steel frame structures (Figures E-12 and E-13) have been built since the late 1800s with similar usage and exterior finish as the steel moment-frame buildings. Braced frames are sometimes used for long and narrow buildings because of their stiffness. Although these buildings are braced with diagonal members, the bracing members usually cannot be detected from the building exterior.

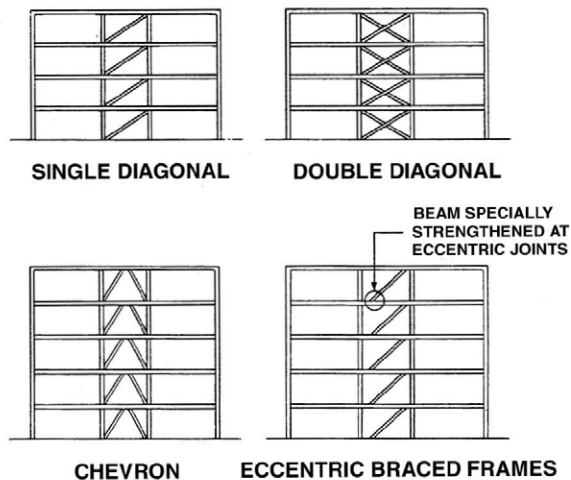

Figure E-12 Braced frame configurations.

From the building exterior, it is usually difficult to tell the difference between steel moment frames, braced frames, and frames with shear walls. In most modern buildings, the bracing or shear walls are located in the interior or covered by cladding material. Figure E-14 shows heavy diagonal bracing for a high rise building, located at the side walls, which

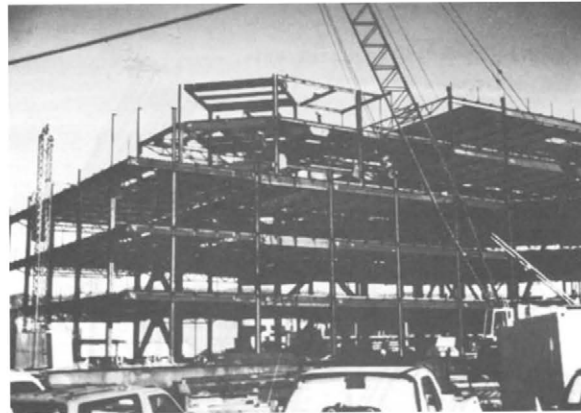

Figure E-13 Braced steel frame, with chevron and diagonal braces. The braces and steel frames are usually covered by finish material after the steel is erected.

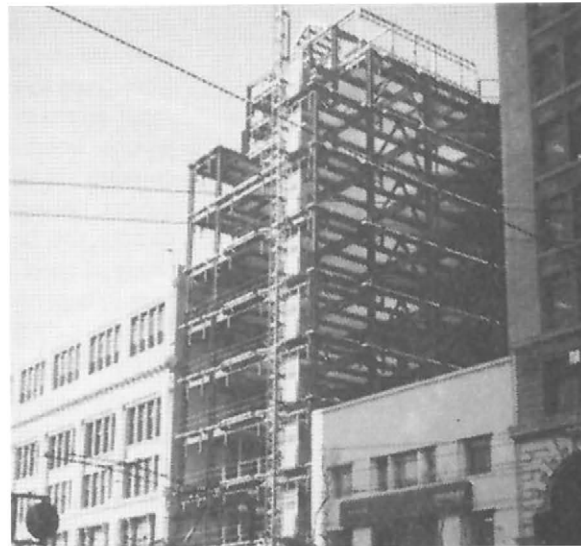

Figure E-14 Chevron bracing in steel building under construction.

will be subsequently covered by finish materials and will not be apparent. In fact, it is difficult to differentiate steel frame structures and concrete frame structures from the exterior. Most of the time, the structural members are clad in finish material. In older buildings, steel members can also be encased in concrete. There are no positive ways of distinguishing these various frame types except in the two cases listed below:

1. If a building can be determined to be a braced frame, it is probably a steel structure.

2. If exposed steel beams and columns can be seen, then the steel frame structure is apparent. (Especially in older structures, a structural frame which appears to be concrete may actually be a steel frame encased in concrete.)

E.3.2 Typical Earthquake Damage

Steel frame buildings tend to be generally satisfactory in their earthquake resistance, because of their strength, flexibility and lightness. Collapse in earthquakes has been very rare, although steel frame buildings did collapse, for example, in the 1985 Mexico City earthquake. In the United States, these buildings have performed well, and probably will not collapse unless subjected to sufficiently severe ground shaking. The 1994 Northridge and 1995 Kobe earthquakes showed that steel frame buildings (in particular S1 moment-frame) were vulnerable to severe earthquake damage. Though none of the damaged buildings collapsed, they were rendered unsafe until repaired. The damage took the form of broken welded connections between the beams and columns. Cracks in the welds began inside the welds where the beam flanges were welded to the column flanges. These cracks, in some cases, broke the welds or propagated into the column flange, “tearing” the flange. The damage was found in those buildings that experienced ground accelerations of approximately 20% of gravity (20%g) or greater. Since 1994 Northridge, many cities that experienced large earthquakes in the recent past have instituted an inspection program to determine if any steel frames were damaged. Since steel frames are usually covered with a finish material, it is difficult to find damage to the joints. The process requires removal of the finishes and removal of fireproofing just to see the joint.

Possible damage includes the following.

1. Nonstructural damage resulting from excessive deflections in frame structures can occur to elements such as interior partitions, equipment, and exterior cladding. Damage to nonstructural elements was the reason for the discovery of damage to moment frames as a result of the 1994 Northridge earthquake.
2. Cladding and exterior finish material can fall if insufficiently or incorrectly connected.
3. Plastic deformation of structural members can cause permanent displacements.
4. Pounding with adjacent structures can occur.

E.3.3 Common Rehabilitation Techniques

As a result of the 1994 Northridge earthquake many steel frame buildings, primarily steel moment frames, have been rehabilitated to address the problems discovered. The process is essentially to redo the connections, ensuring that cracks do not occur in the welds. There is careful inspection of the welding process and the electrodes during construction. Where possible, existing full penetration welds of the beams to the columns is changed so more fillet welding is



Figure E-15 Rehabilitation of a concrete parking structure using exterior X-braced steel frames.

used. This means that less heat is used in the welding process and consequently there is less potential for damage. Other methods include reducing welding to an absolute minimum by developing bolted connections or ensuring that the connection plates will yield (stretch permanently) before the welds will break. One other possibility for rehabilitating moment frames is to convert them to braced frames.

The kind of damage discovered was not limited to moment frames, although they were the most affected. Some braced frames were found to have damage to the brace connections, especially at lower levels.

Structural types other than steel frames are sometimes rehabilitated using steel frames, as shown for the concrete structure in Figure E-15. Probably the most common use of steel frames for rehabilitation is in unreinforced masonry bearing-wall buildings (URM). Steel frames are typically used at the storefront windows as there is no available horizontal resistance provided by the windows in their plane. Frames can be used throughout the first floor perimeter when the floor area needs to be open, as in a restaurant. See Figure E-16.

When a building is encountered with this type of rehabilitation scheme, the building should be considered a frame type building S1 or S2.

E.4 Light Metal (S3)

E.4.1 Characteristics

Most light metal buildings existing today were built after 1950 (Figure E-17). They are used for agricultural structures, industrial factories, and warehouses. They are typically one story in height, sometimes without interior columns, and often enclose a large floor area. Construction is typically of steel frames spanning the short dimension of the building, resisting lateral forces as moment frames. Forces in the long direction are usually resisted by diagonal steel rod bracing. These buildings are usually clad with lightweight metal or asbestos-reinforced concrete siding, often corrugated.

To identify this construction type, the screener should look for the following characteristics:



Figure E-16 Use of a braced frame to rehabilitate an unreinforced masonry building.

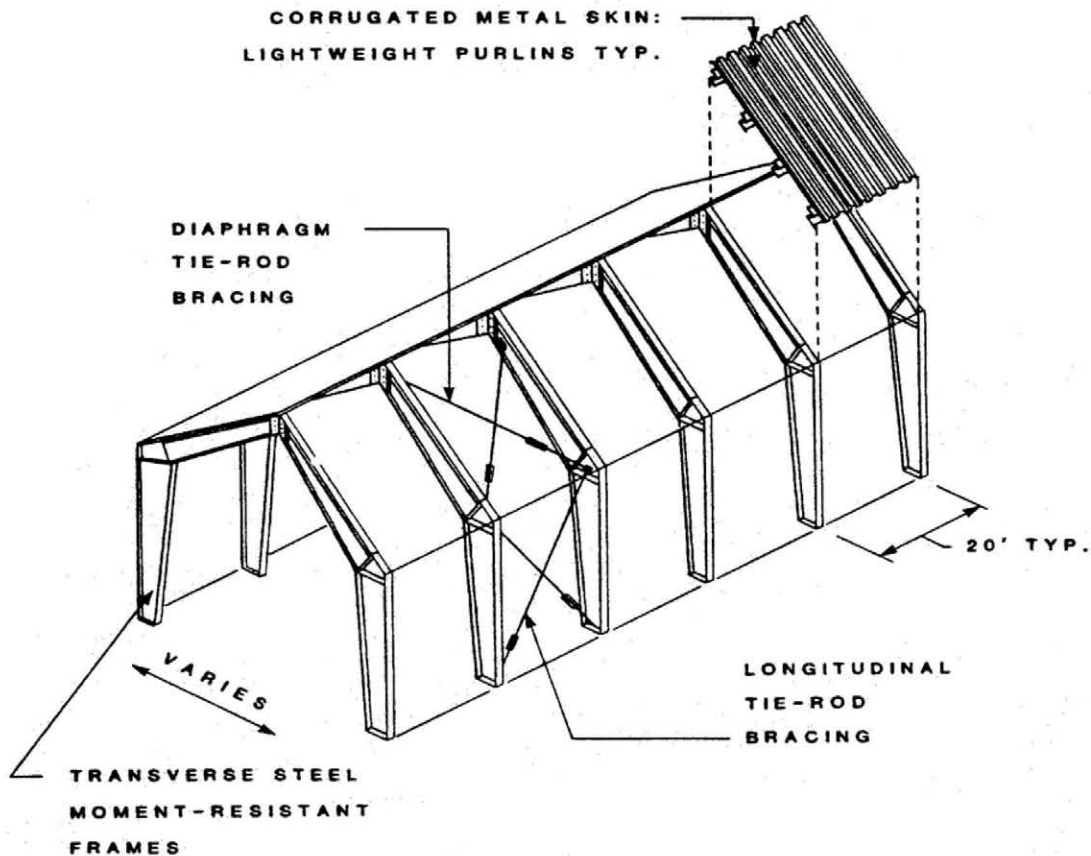

Figure E-17 Drawing of light metal construction.

1. Light metal buildings are typically characterized by industrial corrugated sheet metal or asbestos-reinforced cement siding. The term, “metal building panels” should not be confused with “corrugated sheet metal siding.” The former are prefabricated cladding units usually used for large office buildings. Corrugated sheet metal siding is thin sheet material usually fastened to purlins, which in turn span between columns. If this sheet cladding is present, the screener should examine closely the fasteners used. If the heads of sheet metal screws can be seen in horizontal rows, the building is most likely a light metal structure (Figure E-18).

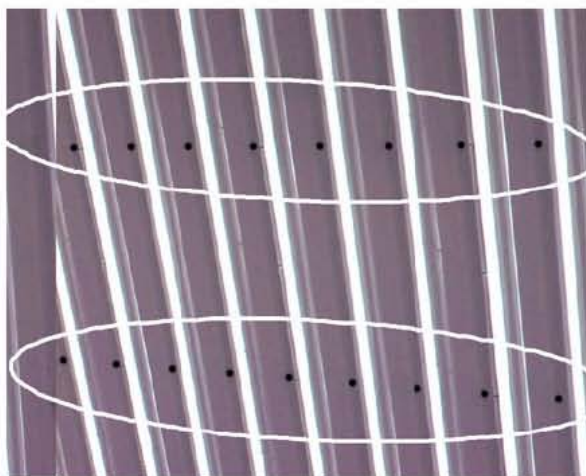

Figure E-18 Connection of metal siding to light metal frame with rows of screws (encircled).

2. Because the typical structural system consists of moment frames in the transverse direction and frames braced with diagonal steel rods in the longitudinal direction, light metal buildings often have low-pitched roofs without parapets or overhangs (Figure E-19). Most of these buildings are prefabricated, so the buildings tend to be rectangular in plan, without many corners.
3. These buildings generally have only a few windows, as it is difficult to detail a window in the sheet metal system.
4. The screener should look for signs of a metal building, and should knock on the siding to see if it sounds hollow. Door openings should be inspected for exposed steel members. If a gap, or light, can be seen where the siding meets the ground, it is certainly light metal or wood frame. For the best indication, an interior inspection will confirm the structural skeleton, because most of these buildings do not have interior finishes.



Figure E-19 Prefabricated metal building (S3, light metal building).

E.4.2 Typical Earthquake Damage

Because these buildings are low-rise, lightweight, and constructed of steel members, they usually perform relatively well in earthquakes. Collapses do not usually occur. Some typical problems are listed below:

1. Insufficient capacity of tension braces can lead to their elongation or failure, and, in turn, building damage.
2. Inadequate connection to the foundation can allow the building columns to slide.
3. Loss of the cladding can occur.

E.5 Steel Frame with Concrete Shear Wall (S4)

E.5.1 Characteristics

The construction of this structural type (Figure E-20) is similar to that of the steel moment-resisting frame in that a matrix of steel columns and girders is distributed throughout the structure. The joints, however, are not designed for moment resistance, and the lateral forces are resisted by concrete shear walls.

It is often difficult to differentiate visually between a steel frame with concrete shear walls and one without, because interior shear walls will often be covered by interior finishes and will look like interior nonstructural partitions. For the purposes of an RVS, unless the shear wall is identifiable from the exterior (i.e., a raw concrete finish was part of the architectural aesthetic of the building, and was left exposed), this building cannot be identified accurately. Figure E-21 shows a structure with such an exposed shear wall. Figure E-22 is a close-up of shear wall damage.

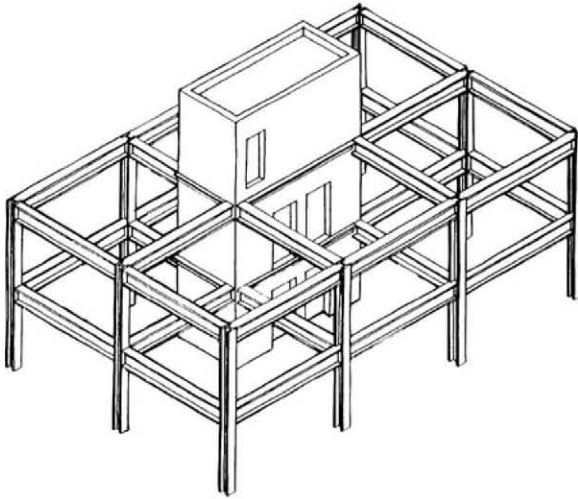

Figure E-20 Drawing of steel frame with interior concrete shear-walls.



Figure E-22 Close-up of exterior shear wall damage during a major earthquake.



Figure E-21 Concrete shear wall on building exterior.

E.5.2 Typical Earthquake Damage

The shear walls can be part of the elevator and service core, or part of the exterior or interior walls. This type of structure performs as well in earthquakes as other steel buildings. Some typical types of damage, other than nonstructural damage and pounding, are:

1. Shear cracking and distress can occur around openings in concrete shear walls.

2. Wall construction joints can be weak planes, resulting in wall shear failure at stresses below expected capacity.
3. Insufficient chord steel lap lengths can lead to wall bending failures.

E.6 Steel Frame with Unreinforced Masonry Infill (S5)

E.6.1 Characteristics

This construction type (Figures E-23 and E-24) consists of a steel structural frame and walls “infilled” with unreinforced masonry (URM). In older buildings, the floor diaphragms are often wood. Later buildings have reinforced concrete floors. Because of the masonry infill, the structure tends to be stiff. Because the steel frame in an older building is covered by unreinforced masonry for fire protection, it is easy to confuse this type of building with URM bearing-wall structures. Further, because the steel columns are relatively thin, they may be hidden in walls. An apparently solid masonry wall may enclose a series of steel columns and girders. These infill walls are usually two or three wythes thick. Therefore, header bricks will sometimes be present and thus mislead the screener into thinking the building is a URM bearing-wall structure, rather than infill. Often in these structures the infill and veneer masonry is exposed. Otherwise, masonry may be obscured by cladding in buildings, especially those that have undergone renovation.

When a masonry building is encountered, the screener should first attempt to determine if the masonry is reinforced, by checking the date of construction, although this is only a rough guide. A

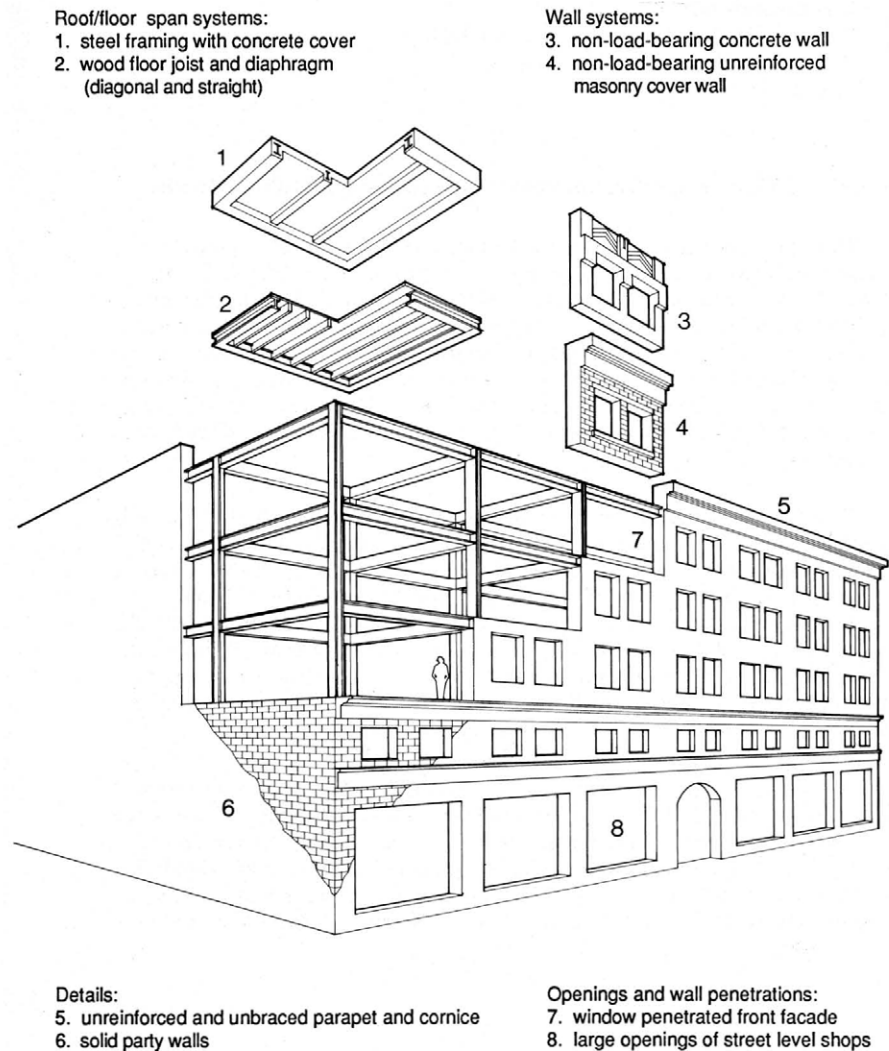

Figure E-23 Drawing of steel frame with URM infill.

clearer indication of a steel frame structure with URM infill is when the building exhibits the characteristics of a frame structure of type S1 or S2. One can assume all frame buildings clad in brick and constructed prior to about 1940 are of this type.

Older frame buildings may be of several types—steel frame encased with URM, steel frame encased with concrete, and concrete frame. Sometimes older buildings have decorative cladding such as terra cotta or stone veneer. Veneers may obscure all evidence of URM. In that case, the structural type cannot be determined. However, if there is evidence that a large amount of concrete is used in the building (for example, a rear wall constructed of concrete), then it is unlikely that the building has URM infill.

When the screener cannot be sure if the building is a frame or has bearing walls, two clues may help—the thickness of the walls and the height. Because infill walls are constructed of two or three wythes of

bricks, they should be approximately 9 inches thick (2 wythes). Furthermore, the thickness of the wall will not increase in the lower stories, because the structural frame is carrying the load. For buildings over six stories tall, URM is infill or veneer, because URM bearing-wall structures are seldom this tall and, if so, they will have extremely thick walls in the lower stories.

E.6.2 Typical Earthquake Damage

In major earthquakes, the infill walls may suffer substantial cracking and deterioration from in-plane or out-of-plane deformation, thus reducing the in-plane wall stiffness. This in turn puts additional demand on the frame. Some of the walls may fail while others remain intact, which may result in torsion or soft story problems.

The hazard from falling masonry is significant as these buildings can be taller than 20 stories. As



Figure E-24 Example of steel frame with URM infill walls (S5).

described below, typical damage results from a variety of factors.

1. Infill walls tend to buckle and fall out-of-plane when subjected to strong lateral forces. Because infill walls are non-load-bearing, they tend to be thin (around 9") and cannot rely on the additional shear strength that accompanies vertical compressive loads.
2. Veneer masonry around columns or beams is usually poorly anchored to the structural members and can disengage and fall.
3. Interior infill partitions and other nonstructural elements can be severely damaged and collapse.
4. If stories above the first are infilled, but the first is not (a soft story), the difference in stiffness creates a large demand at the ground floor columns, causing structural damage.
5. When the earthquake forces are sufficiently high, the steel frame itself can fail locally. Connections between members are usually not designed for high lateral loads (except in tall buildings) and this can lead to damage of these connections. Complete collapse has seldom occurred, but cannot be ruled out.

E.6.3 Common Rehabilitation Techniques

Rehabilitation techniques for this structural type have focused on the expected damage. By far the most significant problem, and that which is addressed in most rehabilitation schemes, is failure of the infill wall out of its plane. This failure presents a significant life safety hazard to individuals on the exterior of the building, especially those who manage to exit the building during the earthquake. To remedy this problem, anchorage connections are developed to tie the masonry infill to the floors and roof of the structure.

Another significant problem is the inherent lack of shear strength throughout the building. Some of the rehabilitation techniques employed include the following.

1. Gunitite (with pneumatically placed concrete) the interior faces of the masonry wall, creating reinforced concrete shear elements.
2. Rehabilitate the steel frames by providing cross bracing or by fully strengthening the connections to create moment frames. In this latter case, the frames are still not sufficient to resist all the lateral forces, and reliance on the infill walls is necessary to provide adequate strength.

For concrete moment frames the rehabilitation techniques have been to provide ductile detailing. This is usually done by removing the outside cover of concrete (a couple of inches) exposing the reinforcing ties. Additional ties are added with their ends embedded into the core of the column. The exterior concrete is then replaced. This process results in a detail that provides a reasonable amount of ductility but not as much as there would have been had the ductility been provided in the original design.

E.7 Concrete Moment-Resisting Frame (C1)

E.7.1 Characteristics

Concrete moment-resisting frame construction consists of concrete beams and columns that resist both lateral and vertical loads (see Figure E-25). A fundamental factor in the seismic performance of concrete moment-resisting frames is the presence or absence of ductile detailing. Hence, several construction subtypes fall under this category:

- a. non-ductile reinforced-concrete frames with unreinforced infill walls,
- b. non-ductile reinforced-concrete frames with reinforced infill walls,
- c. non-ductile reinforced-concrete frames, and

- Roof/floor diaphragms:
1. concrete waffle slab
 2. concrete joist and slab
 3. steel decking with concrete topping

- Curtain wall/ non-structural infill:
4. masonry infill walls
 5. stone panels
 6. metal skin panels
 7. glass panels
 8. precast concrete panels

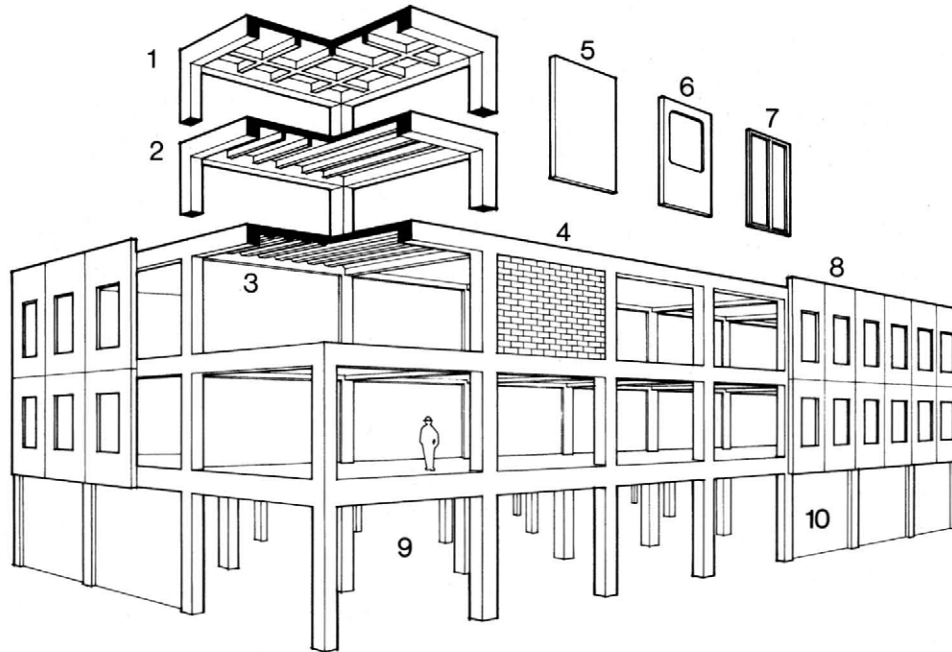

- Structural system:
9. distributed concrete frame

- Details:
10. typical tall first floor (soft story)

Figure E-25 Drawing of concrete moment-resisting frame building.

d. ductile reinforced-concrete frames.

Ductile detailing refers to the presence of special steel reinforcing within concrete beams and columns. The special reinforcement provides confinement of the concrete, permitting good performance in the members beyond the elastic capacity, primarily in bending. Due to this confinement, disintegration of the concrete is delayed, and the concrete retains its strength for more cycles of loading (i.e., the ductility is increased). See Figure E-26 for a dramatic example of ductility in concrete.

Ductile detailing (Figure E-27) has been practiced in high-seismicity areas since 1967, when ductility requirements were first introduced into the *Uniform Building Code* (the adoption and enforcement of ductility requirements in a given jurisdiction



Figure E-26 Extreme example of ductility in concrete, 1994 Northridge earthquake.



Figure E-27 Example of ductile reinforced concrete column, 1994 Northridge earthquake; horizontal ties would need to be closer for greater demands.

may be later, however). Prior to that time, nonductile or ordinary concrete moment-resisting frames were the norm (and still are, for moderate seismic areas). In high-seismicity areas additional tie reinforcing was required following the 1971 San Fernando earthquake and appeared in the *Uniform Building Code* in 1976.

In many low-seismicity areas of the United States, non-ductile concrete frames of type (a), (b), and (c) continue to be built. This group includes large multistory commercial, institutional, and residential buildings constructed using flat slab frames, waffle slab frames, and the standard beam-and-column frames. These structures generally are more massive than steel-frame buildings, are under-reinforced (i.e., have insufficient reinforcing steel embedded in the concrete) and display low ductility.

This building type is difficult to differentiate from steel moment-resisting frames unless the structural concrete has been left relatively exposed (see Figure E-28). Although a steel frame may be encased in concrete and appear to be a concrete frame, this is seldom the case for modern buildings (post 1940s). For the purpose of the RVS procedures, it can be assumed that all exposed concrete frames are concrete and not steel frames.



Figure E-28 Concrete moment-resisting frame building (C1) with exposed concrete, deep beams, wide columns (and with architectural window framing).

E.7.2 Typical Earthquake Damage

Under high amplitude cyclic loading, lack of confinement will result in rapid disintegration of nonductile concrete members, with ensuing brittle failure and possible building collapse (see Figure E-29).

Causes and types of damage include:

1. Excessive tie spacing in columns can lead to a lack of concrete confinement and shear failure.
2. Placement of inadequate rebar splices all at the same location in a column can lead to column failure.
3. Insufficient shear strength in columns can lead to shear failure prior to the full development of moment hinge capacity.
4. Insufficient shear tie anchorage can prevent the column from developing its full shear capacity.
5. Lack of continuous beam reinforcement can result in unexpected hinge formation during load reversal.



Figure E-29 Locations of failures at beam-to-column joints in nonductile frames, 1994 Northridge earthquake.

6. Inadequate reinforcing of beam-column joints or the positioning of beam bar splices at columns can lead to failures.
7. The relatively low stiffness of the frame can lead to substantial nonstructural damage.
8. Pounding damage with adjacent buildings can occur.

E.7.3 Common Rehabilitation Techniques

Rehabilitation techniques for reinforced concrete frame buildings depend on the extent to which the frame meets ductility requirements. The costs associated with the upgrading an existing, conventional beam-column framing system to meet the minimum standards for ductility are high and this approach is usually not cost-effective. The most practical and cost-effective solution is to add a system of shear walls or braced frames to provide the required seismic resistance (ATC, 1992).

E.8 Concrete Shear Wall (C2)

E.8.1 Characteristics

This category consists of buildings with a perimeter concrete bearing-wall structural system or frame

structures with shear walls (Figure E-30). The structure, including the usual concrete floor diaphragms, is typically cast in place. Before the 1940s, bearing-wall systems were used in schools, churches, and industrial buildings. Concrete shear-wall buildings constructed since the early 1950s are institutional, commercial, and residential buildings, ranging from one to more than thirty stories. Frame buildings with shear walls tend to be commercial and industrial. A common example of the latter type is a warehouse with interior frames and perimeter concrete walls. Residential buildings of this type are often mid-rise towers. The shear walls in these newer buildings can be located along the perimeter, as interior partitions, or around the service core.

Frame structures with interior shear walls are difficult to identify positively. Where the building is clearly a box-like bearing-wall structure it is probably a shear-wall structure. Concrete shear wall buildings are usually cast in place. The screener should look for signs of cast-in-place concrete. In concrete bearing-wall structures, the wall thickness ranges from 6 to 10 inches and is thin in comparison to that of masonry bearing-wall structures.

SIMPLIFIED DESCRIPTION OF TYPICAL BUILDINGS

Roof/floor span systems:
1. heavy timber rafter roof
2. concrete joist and slab
3. concrete flat slab

Wall system:
4. interior and exterior concrete bearing walls
5. large window penetrations of school and hospital buildings

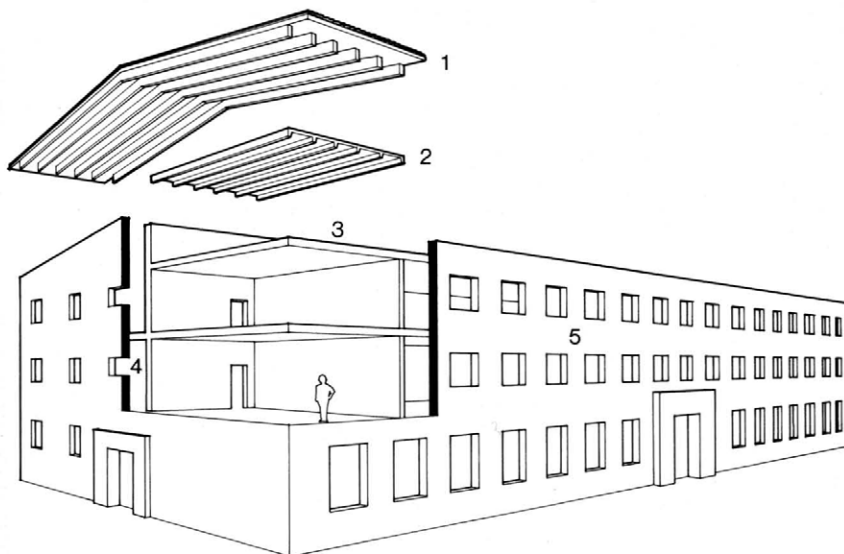

Figure E-30 Drawing of concrete shear-wall building.

E.8.2 Typical Types of Earthquake Damage

This building type generally performs better than concrete frame buildings. The buildings are heavy compared with steel frame buildings, but they are also stiff due to the presence of the shear walls. Damage commonly observed in taller buildings is caused by vertical discontinuities, pounding, and irregular configuration. Other damage specific to this building type includes the following.

1. During large seismic events, shear cracking and distress can occur around openings in concrete shear walls and in spandrel beams and link beams between shear walls (See Figures E-31 and E-32.)
2. Shear failure can occur at wall construction joints usually at a load level below the expected capacity.
3. Bending failures can result from insufficient vertical chord steel and insufficient lap lengths at the ends of the walls.

E.8.3 Common Rehabilitation

Reinforced concrete shear-wall buildings can be rehabilitated in a variety of ways. Techniques

include: (1) reinforcing existing walls in shear by applying a layer of shotcrete or poured concrete; (2) where feasible, filling existing window or door openings with concrete to add shear strength and eliminate critical bending stresses at the edge of openings; and (3) reinforcing narrow overstressed shear panels in in-plane bending by adding reinforced boundary elements (ATC, 1992).

E.9 Concrete Frame with Unreinforced Masonry Infill (C3)

E.9.1 Characteristics

These buildings (Figures E-33 and E-34) have been, and continue to be, built in regions where unreinforced masonry (URM) has not been eliminated by code. These buildings were generally built before 1940 in high-seismicity regions and may continue to be built in other regions.

The first step in identification is to determine if the structure is old enough to contain URM. In contrast to steel frames with URM infill, concrete frames with URM infill usually show clear evidence of the concrete frames. This is particularly true for industrial buildings and can usually be observed at the side or rear of commercial buildings. The concrete col-



Figure E-31 Tall concrete shear-wall building: walls connected by damaged spandrel beams.

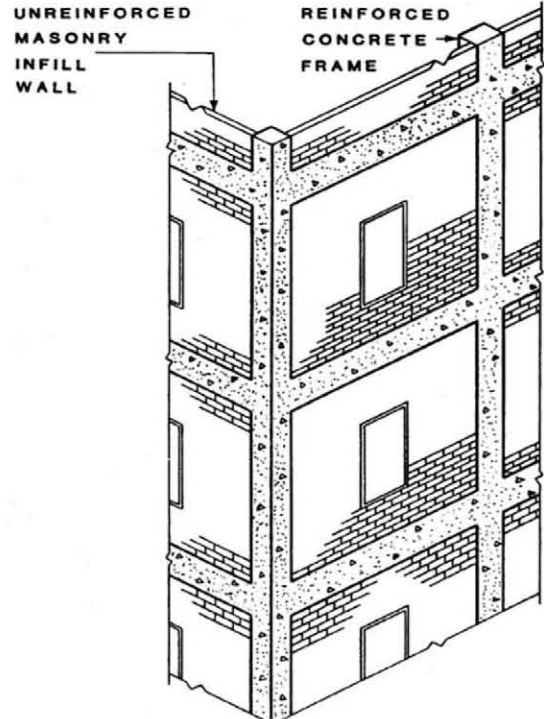

Figure E-33 Concrete frame with URM infill.



Figure E-32 Shear-wall damage, 1989 Loma Prieta earthquake.



Figure E-34 Blow-up (lower photo) of distant view of C3 building (upper photo) showing concrete frame with URM infill (left wall), and face brick (right wall).

umns and beams are relatively large and are usually not covered by masonry but left exposed.

A case in which URM infill cannot be readily identified is the commercial building with large windows on all sides; these buildings may have interior URM partitions. Another difficult case occurs when the exterior walls are covered by decorative tile or

stone veneer. The infill material can be URM or a thin concrete infill.

E.9.2 Typical Earthquake Damage

The hazards of these buildings, which in the western United States are often older, are similar to and perhaps more severe than those of the newer concrete frames. Where URM infill is present, a falling hazard exists. The failure mechanisms of URM infill in a concrete frame are generally the same as URM infill in a steel frame.

E.9.3 Common Rehabilitation Techniques

Rehabilitation of unreinforced masonry infill in a concrete frame is identical to that of the URM infill in a steel frame. See Section E.6.3. Anchorage of the wall panels for out-of-plane forces is the key component, followed by providing sufficient shear strength in the building.

E.10 Tilt-up Structures (PC1)

E.10.1 Characteristics

In traditional tilt-up buildings (Figures E-35 through E-37), concrete wall panels are cast on the ground

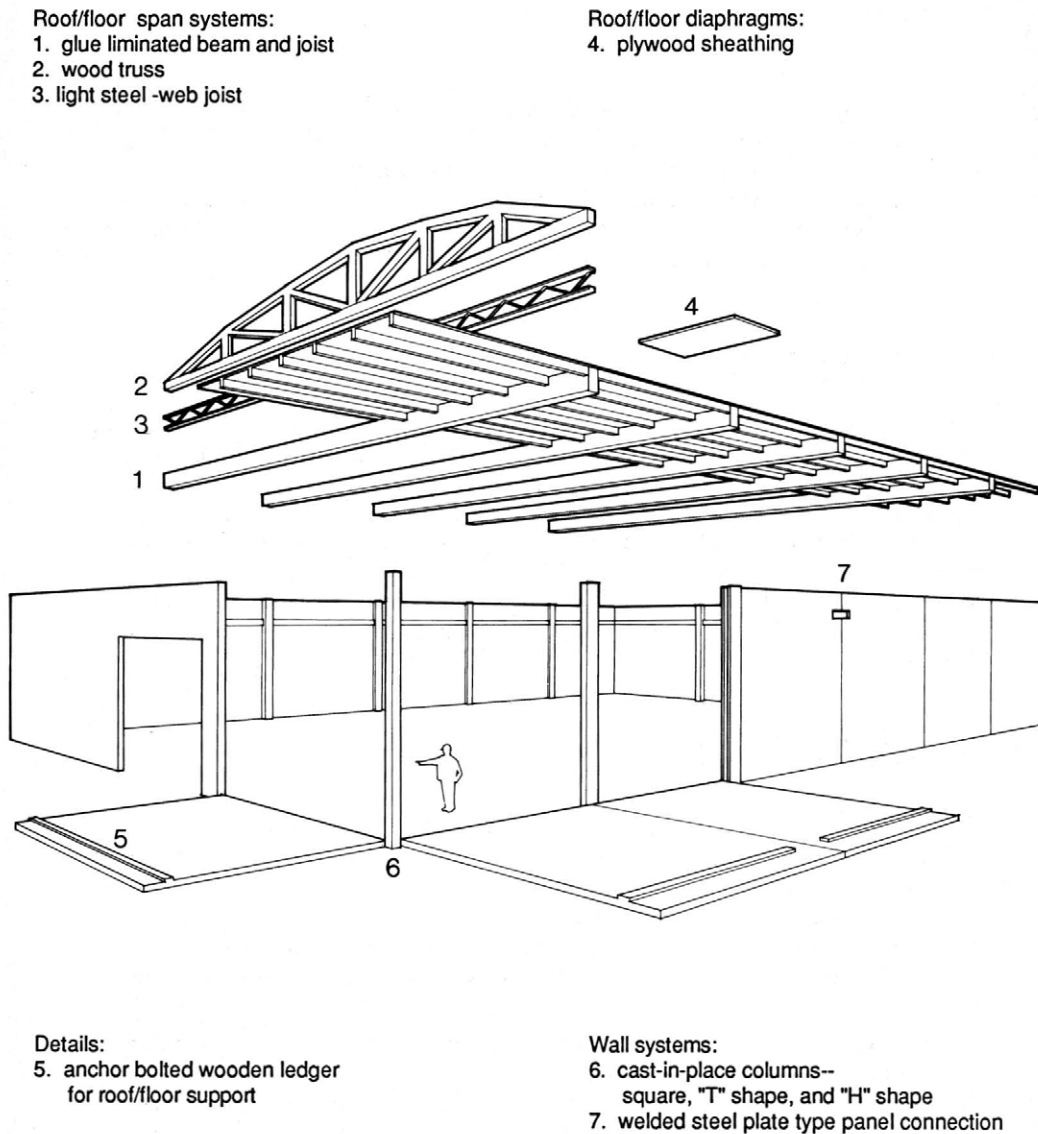

Figure E-35 Drawing of tilt-up construction typical of the western United States. Tilt-up construction in the eastern United States may incorporate a steel frame.



Figure E-36 Tilt-up industrial building, 1970s.



Figure E-37 Tilt-up industrial building, mid- to late 1980s.

and then tilted upward into their final positions. More recently, wall panels are fabricated off-site and trucked to the site.

Tilt-up buildings are an inexpensive form of light industrial and commercial construction and have become increasingly popular in the western and central United States since the 1940s. They are typically one and sometimes two stories high and basically have a simple rectangular plan. The walls are the lateral-force-resisting system. The roof can be a plywood diaphragm carried on wood purlins and glue-laminated (glulam) wood beams or a light steel deck and joist system, supported in the interior of the building on steel pipe columns. The wall panels are attached to concrete cast-in-place pilasters or to steel columns, or the joint is simply closed with a later concrete pour. These joints are typically spaced about 20 feet apart.

The major defect in existing tilt-ups is a lack of positive anchorage between wall and diaphragm, which has been corrected since about 1973 in the western United States.

In the western United States, it can be assumed that all one-story concrete industrial warehouses with

flat roofs built after 1950 are tilt-ups unless supplementary information indicates otherwise.

E.10.2 Typical Earthquake Damage

Before 1973 in the western United States, many tilt-up buildings did not have sufficiently strong connections or anchors between the walls and the roof and floor diaphragms. The anchorage typically was nothing more than the nailing of the plywood roof sheathing to the wood ledgers supporting the framing.

During an earthquake, the weak anchorage broke the ledgers, resulting in the panels falling and the supported framing to collapse. When mechanical anchors were used they pulled out of the walls or split the wood members to which they were attached, causing the floors or roofs to collapse. See Figures E-38 and E-39. The connections between the concrete panels are also vulnerable to failure. Without these connections, the building loses much of its lateral-force-resisting capacity. For these reasons, many tilt-up buildings were damaged in the 1971 San



Figure E-38 Tilt-up construction anchorage failure.



Figure E-39 Result of failure of the roof beam anchorage to the wall in tilt-up building.

Fernando, California, earthquake. Since 1973, tilt-up construction practices have changed in California and other high-seismicity regions, requiring positive wall-diaphragm connection. (Such requirements may not have yet been made in other regions of the country.) However, a large number of these older, pre-1970s-vintage tilt-up buildings still exist and have not been rehabilitated to correct this wall-anchor defect. Damage to these buildings was observed again in the 1987 Whittier, California, earthquake, 1989 Loma Prieta, California earthquake, and the 1994 Northridge, California, earthquake. These buildings are a prime source of seismic hazard.

In areas of low or moderate seismicity, inadequate wall anchor details continue to be used. Severe ground shaking in such an area may produce major damage in tilt-up buildings.

E.10.3 Common Rehabilitation Techniques

The rehabilitation of tilt-up buildings is relatively easy and inexpensive. The most common form of rehabilitation is to provide a positive anchorage connection at the roof and wall intersection. This is usually done by using pre-fabricated metal hardware attached to the framing member and to a bolt that is installed through the wall. On the outside of the wall a large washer plate is used. See Figure E-40 for examples of new anchors.

Accompanying the anchorage rehabilitation is the addition of ties across the building to develop the anchorage forces from the wall panels fully into the diaphragm. This is accomplished by interconnecting framing members from one side of the building to the other, and then increasing the connections of the diaphragm (usually wood) to develop the additional forces.

E.11 Precast Concrete Frame (PC2)

E.11.1 Characteristics

Precast concrete frame construction, first developed in the 1930s, was not widely used until the 1960s. The precast frame (Figure E-41) is essentially a post and beam system in concrete where columns, beams and slabs are prefabricated and assembled on site. Various types of members are used. Vertical-load-carrying elements may be Ts, cross shapes, or arches and are often more than one story in height. Beams are often Ts and double Ts, or rectangular sections. Prestressing of the members, including pretensioning and post-tensioning, is often employed. The identification of this structure type cannot rely solely on construction date, although most precast concrete



Figure E-40 Newly installed anchorage of roof beam to wall in tilt-up building.

frame structures were constructed after 1960. Some typical characteristics are the following.

1. Precast concrete, in general, is of a higher quality and precision compared to cast-in-place concrete. It is also available in a greater range of textures and finishes. Many newer concrete and steel buildings have precast concrete panels and column covers as an exterior finish (See Figure E-42). Thus, the presence of precast concrete does not necessarily mean that it is a precast concrete frame.
2. Precast concrete frames are, in essence, post and beam construction in concrete. Therefore, when a concrete structure displays the features of a post-and-beam system, it is most likely that it is a precast concrete frame. It is usually not economical for a conventional cast-in-place concrete frame to look like a post-and-beam system. Features of a precast concrete post-and-beam system include:
 - a. exposed ends of beams and girders that project beyond their supports or project away from the building surface,

Roof/floor span systems:

1. structural concrete "T" sections
2. structural double "T" sections
3. hollow core concrete slab

Wall systems:

4. load-bearing frame components (cross)
5. multi-story load-bearing panels

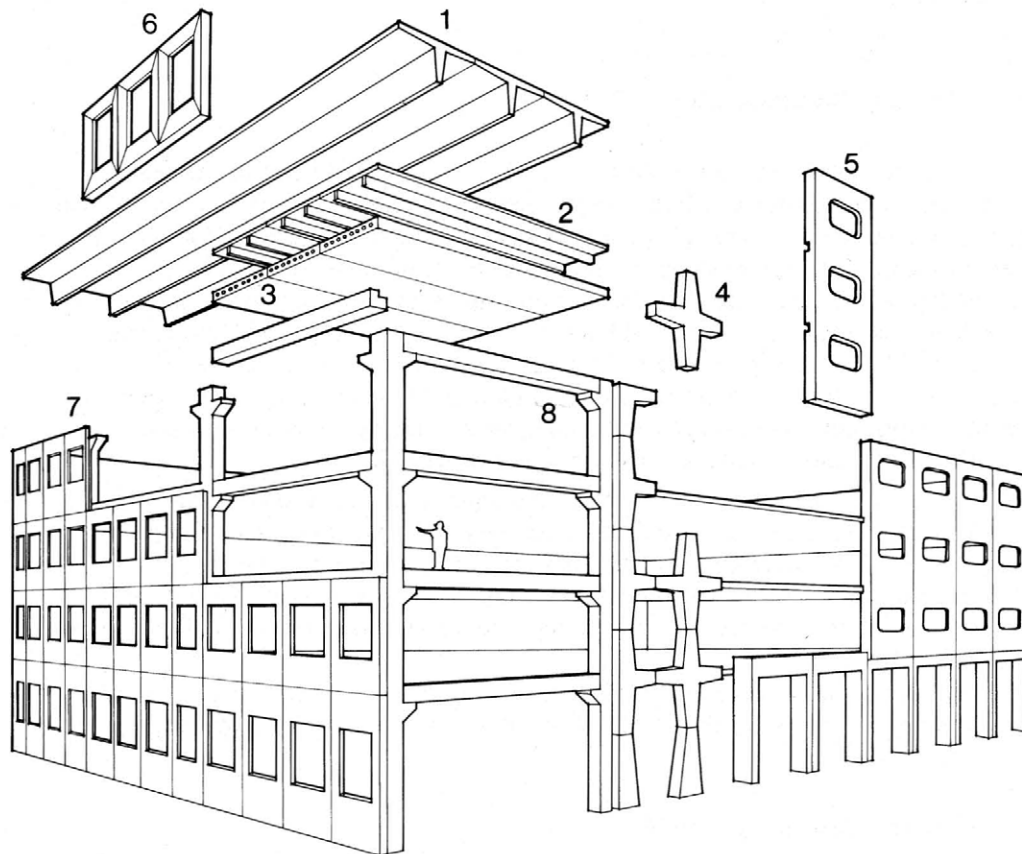

Curtain wall system:

6. precast concrete panels
7. metal, glass, or stone panels

Structural system:

8. precast column and beams

Figure E-41 Drawing of precast concrete frame building.

- the absence of small joists, and
- beams sitting on top of girders rather than meeting at a monolithic joint (see Figure E-43)

The presence of precast structural components is usually a good indication of this system, although these components are also used in mixed construction. Precast structural components come in a variety of shapes and sizes. The most common types are sometimes difficult to detect from the street. Less common but more obvious examples include the following.

- Ts or double Ts—These are deep beams with thin webs and flanges and with large span capacities.

(Figure E-44 shows one end of a double-T beam as it is lowered onto its seat.)

- Cross or T-shaped units of partial columns and beams — These are structural units for constructing moment-resisting frames. They are usually joined together by field welding of steel connectors cast into the concrete. Joints should be clearly visible at the mid-span of the beams or the mid-height of the columns. See Figure E-45.
- Precast arches—Precast arches and pedestals are popular in the architecture of these buildings.
- Column—When a column displays a precast finish without an indication that it has a cover (i.e.,



Figure E-42 Typical precast column cover on a steel or concrete moment frame.

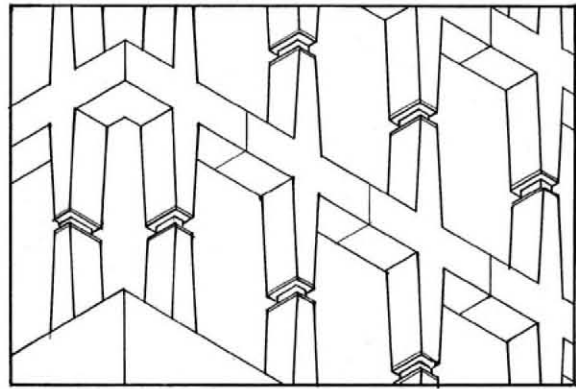

Figure E-45 Precast structural cross; installation joints are at sections where bending is minimum during high seismic demand.

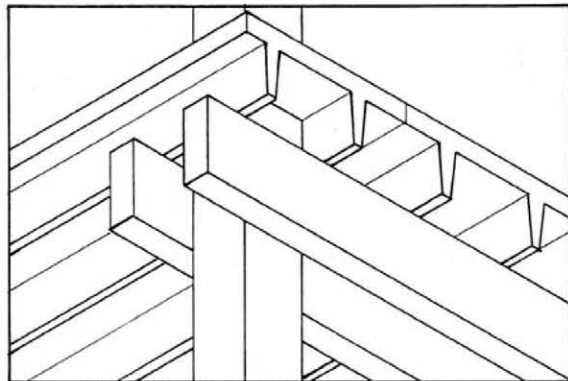

Figure E-43 Exposed precast double-T sections and overlapping beams are indicative of precast frames.



Figure E-44 Example of precast double-T section during installation.

no vertical seam can be found), the column is likely to be a precast structural column.

It is possible that a precast concrete frame may not show any of the above features, however.

E.11.2 Typical Earthquake Damage

The earthquake performance of this structural type varies widely and is sometimes poor. This type of building can perform well if the detailing used to connect the structural elements have sufficient strength and ductility (toughness). Because structures of this type often employ cast-in-place concrete or reinforced masonry (brick or block) shear walls for lateral-load resistance, they experience the same types of damage as other shear-wall building types. Some of the problem areas specific to precast frames are listed below.

1. Poorly designed connections between prefabricated elements can fail.
2. Accumulated stresses can result due to shrinkage and creep and due to stresses incurred in transportation.
3. Loss of vertical support can occur due to inadequate bearing area and insufficient connection between floor elements and columns.
4. Corrosion of the metal connectors between prefabricated elements can occur.

E.11.3 Common Rehabilitation Techniques

Seismic rehabilitation techniques for precast concrete frame buildings are varied, depending on the elements being strengthened. Inadequate shear capacity of floor diaphragms can be addressed by adding reinforced concrete topping to an untopped system when

possible, or adding new shear walls to reduce the seismic shear forces in the diaphragm. Corbels with inadequate vertical shear or bending strength can be strengthened by adding epoxied horizontal shear dowels through the corbel and into the column. Alternatively, vertical shear capacity can be increased by adding a structural steel bolster under the corbel, bolted to the column, or a new steel column or reinforced concrete column can be added (ATC, 1992).

E.12 Reinforced Masonry (RM1 and RM2)

E.12.1 Characteristics

Reinforced masonry buildings are mostly low-rise structures with perimeter bearing walls, often with wood diaphragms (RM1 buildings) although precast concrete is sometimes used (RM2 buildings). Floor and roof assemblies usually consist of timber joists and beams, glued-laminated beams, or light steel joists. The bearing walls consist of grouted and reinforced hollow or solid masonry units. Interior supports, if any, are often wood or steel columns, wood stud frames, or masonry walls. Occupancy varies from small commercial buildings to residential and industrial buildings. Generally, they are less than five stories in height although many taller masonry buildings exist. Reinforced masonry structures are usually basically rectangular structures (See Figure E-46).



Figure E-46 Modern reinforced brick masonry.

To identify reinforced masonry, one must determine separately if the building is masonry and if it is reinforced. To obtain information on how to recognize a masonry structure, see Appendix D, which describes the characteristics of construction materials. The best way of assessing the reinforcement condition is to compare the date of construction with the date of code requirement for the reinforcement of masonry in the local jurisdiction.

The screener also needs to determine if the building is veneered with masonry or is a masonry building. Wood siding is seldom applied over masonry. If the front facade appears to be reinforced masonry whereas the side has wood siding, it is probably a wood frame that has undergone facade renovation. The back of the building should be checked for signs of the original construction type.

If it can be determined that the bearing walls are constructed of concrete blocks, they may be reinforced. Load-bearing structures using these blocks are probably reinforced if the local code required it. Concrete blocks come in a variety of sizes and textures. The most common size is 8 inches wide by 16 inches long by 8 inches high. Their presence is obvious if the concrete blocks are left as the finish surface.

E.12.2 Typical Earthquake Damage

Reinforced masonry buildings can perform well in moderate earthquakes if they are adequately reinforced and grouted, and if sufficient diaphragm anchorage exists. A major problem is control of the workmanship during construction. Poor construction practice can result in ungrouted and unreinforced walls. Even where construction practice is adequate, insufficient reinforcement in the design can be responsible for heavy damage of the walls. The lack of positive connection of the floor and roof diaphragms to the wall is also a problem.

E.12.3 Common Rehabilitation Techniques

Techniques for seismic rehabilitation of reinforced masonry bearing wall buildings are varied, depending on the element being rehabilitated. Techniques for rehabilitating masonry walls include: (1) applying a layer of concrete or shotcrete to the existing walls; (2) adding vertical reinforcing and grouting into ungrouted block walls; and (3) filling in large or critical openings with reinforced concrete or masonry dowelled to the surrounding wall. Wood or steel deck diaphragms in RM1 buildings can be rehabilitated by adding an additional layer of plywood to strengthen and stiffen an existing wood diaphragm, by shear welding between sections of an existing steel deck or adding flat sheet steel reinforcement, or by adding additional vertical elements (for example, shear walls or braced frames) to decrease diaphragm spans and stresses. Precast floor diaphragms in RM2 buildings can be strengthened by adding a layer of concrete topping reinforced with mesh (if the supporting structure has the capacity to carry the additional vertical dead load), or by adding new shear walls to reduce the diaphragm span (ATC, 1992).

Roof/floor span systems:

1. wood post and beam (heavy timber)
2. wood post, beam, and joist (mill construction)
3. wood truss-- pitch and curve

Roof/floor diaphragms:

4. diagonal sheathing
5. straight sheathing

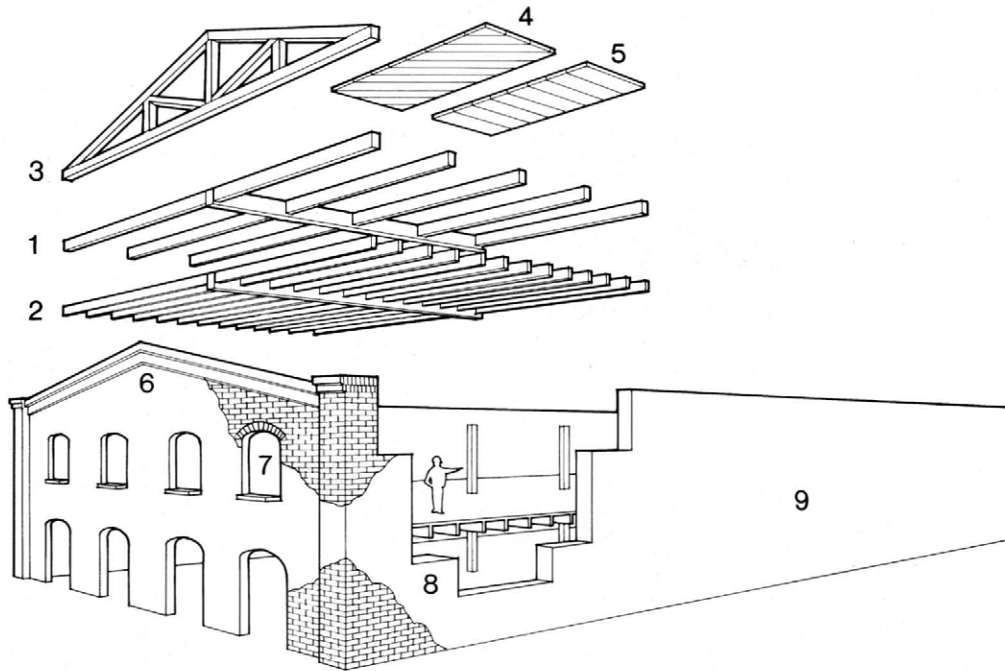

Details:

6. typical unbraced parapet and cornice
7. flat arch window openings

Wall systems:

8. bearing wall-- four or more wythes of brick
9. typical long solid party wall

Figure E-47 Drawing of unreinforced masonry bearing-wall building, 2-story.

E.13 Unreinforced Masonry (URM)

E.13.1 Characteristics

Most unreinforced masonry (URM) bearing-wall structures in the western United States (Figures E-47 through E-51) were built before 1934, although this construction type was permitted in some jurisdictions having moderate or high seismicity until the late 1940s or early 1950s (in some jurisdictions URM may still be a common type of construction, even today). These buildings usually range from one to six stories in height and function as commercial, residential, or industrial buildings. The construction varies according to the type of use, although wood floor and roof diaphragms are common. Smaller commercial and residential buildings usually have light wood

floor joists and roof joists supported on the typical perimeter URM wall and interior, wood, load-bearing partitions. Larger buildings, such as industrial warehouses, have heavier floors and interior columns, usually of wood. The bearing walls of these industrial buildings tend to be thick, often as much as 24 inches or more at the base. Wall thickness of residential, commercial, and office buildings range from 9 inches at upper floors to 18 inches a lower floors.

The first step in identifying buildings of this type is to determine if the structure has bearing walls. Second, the screener should determine the approximate age of the building. Some indications of unreinforced masonry are listed below.

1. Weak mortar was used to bond the masonry units together in much of the early unreinforced

Roof/floor span systems:

1. wood post and beam (heavy timber)
2. wood post, beam, and joist (mill construction)
3. wood truss-- pitch and curve

Roof/floor diaphragms:

4. diagonal sheathing
5. straight sheathing

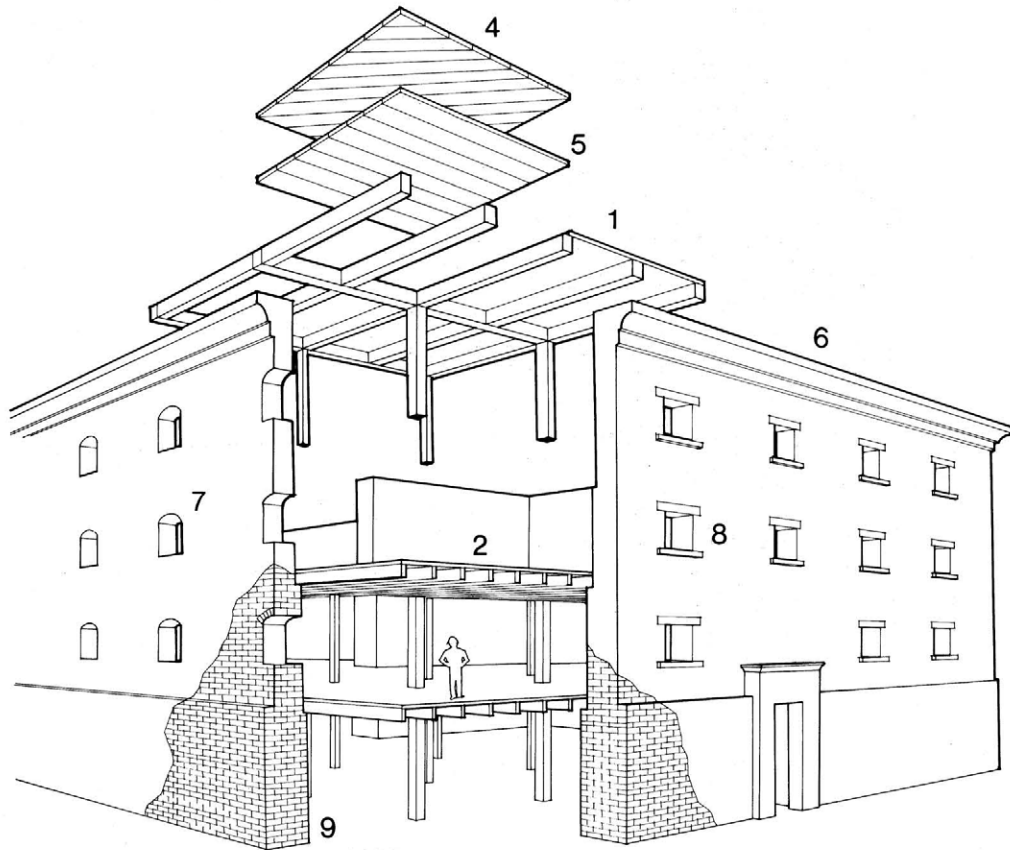

Details:

6. typical unbraced parapet and cornice
7. flat arch window openings
8. small window penetrations (if bldg is originally a warehouse)

Wall systems:

9. bearing wall-- four to eight wythes of brick

Figure E-48 Drawing of unreinforced masonry bearing-wall building, 4-story.

masonry construction in the United States. As the poor earthquake performance of this mortar type became known in the 1930s, and as cement mortar became available, this weaker mortar was not used and thus is not found in more recent masonry buildings. If this soft mortar is present, it is probably URM. Soft mortar can be scratched with a hard instrument such as a penknife, screwdriver, or a coin. This scratch testing, if permitted, should be done in a wall area where the original structural material is exposed, such as

the sides or back of a building. Newer masonry may be used in renovations and it may look very much like the old. Older mortar joints can also be repointed (i.e., regular maintenance of the masonry mortar), or repaired with newer mortar during renovation. The original construction may also have used a high-quality mortar. Thus, even if the existence of soft mortar cannot be detected, it may still be URM.

2. An architectural characteristic of older brick bearing-wall structures is the arch and flat arch

- Roof/floor span systems:
1. wood post and beam (heavy timber)
 2. wood post, beam, and joist (mill construction)

- Roof/floor diaphragms:
3. diagonal sheathing
 4. straight sheathing

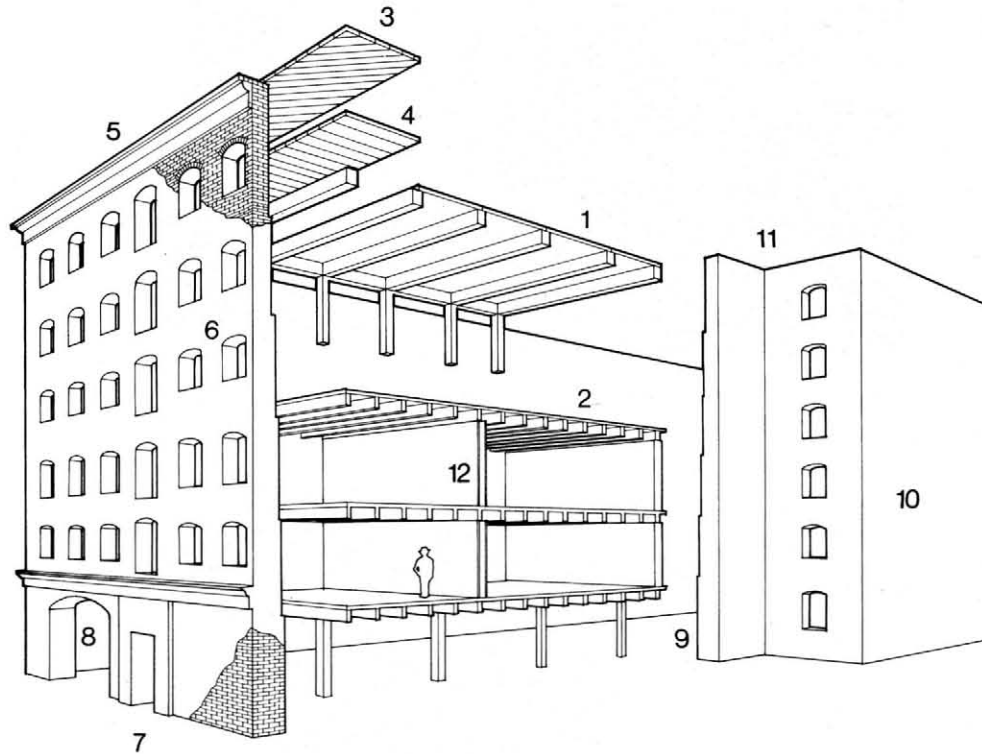

- Details:
5. typical unbraced parapet and cornice
 6. flat arch window openings
 7. typical penetrated facade of residential buildings
 8. large openings of ground floor shops

- Wall systems:
9. bearing wall-- four to eight wythes of brick
 10. typical long solid party wall
 11. light/ventilation wells in residential bldg
 12. non-structural wood stud partition walls

Figure E-49 Drawing of unreinforced masonry bearing-wall building, 6-story.



Figure E-50 East coast URM bearing-wall building.



Figure E-51 West coast URM bearing-wall building.

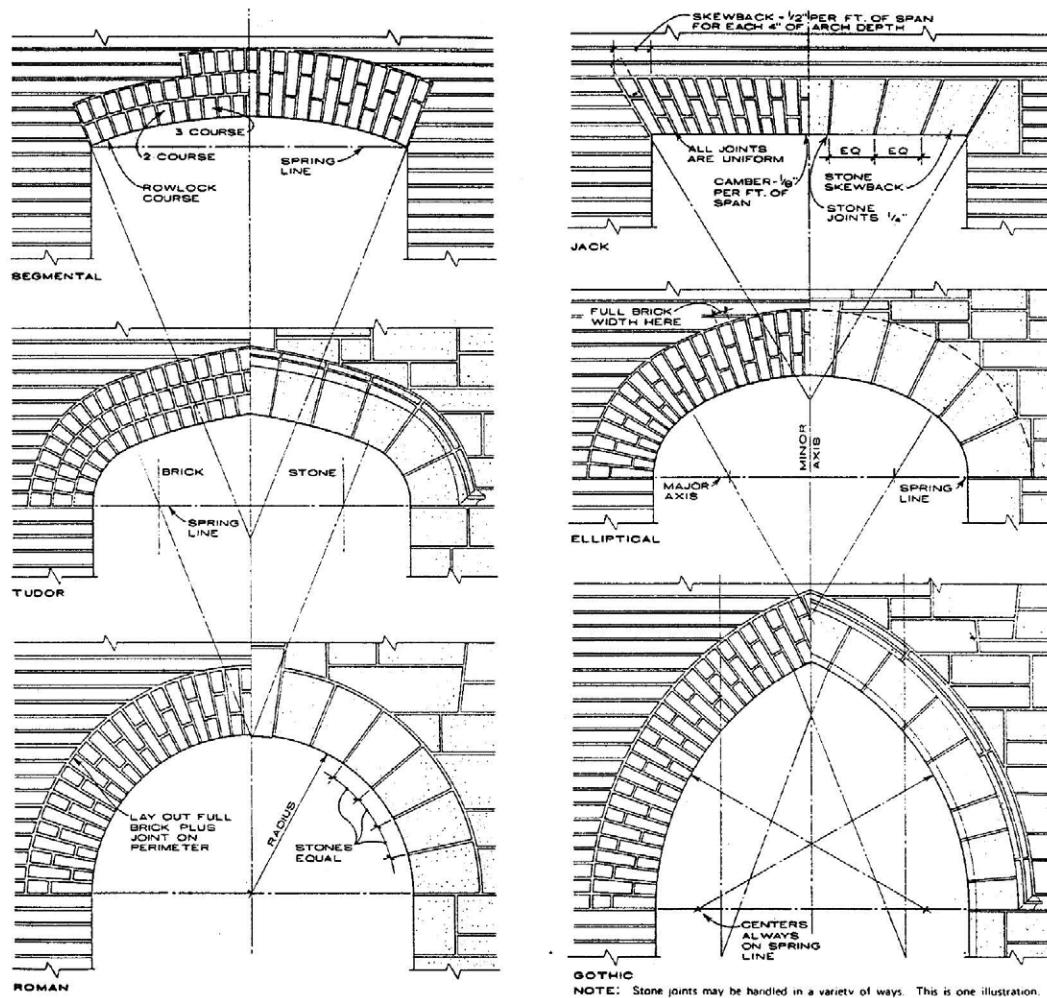

Figure E-52 Drawings of typical window head features in URM bearing-wall buildings.

window heads (see Figure E-52). These arrangements of masonry units function as a header to carry the load above the opening to either side. Although masonry-veneered wood-frame structures may have these features, they are much more widely used in URM bearing-wall structures, as they were the most economical method of spanning over a window opening at the time of construction. Other methods of spanning are also used, including steel and stone lintels, but these methods are generally more costly and usually employed in the front facade only.

3. Some structures of this type will have anchor plates visible at the floor and roof lines, approximately 6-10 feet on center around the perimeter of the building. Anchor plates are usually square or diamond-shaped steel plates approximately 6 inches by 6 inches, with a bolt and nut at the center. Their presence indicates anchor ties have been placed to tie the walls to the floors and roof.

These are either from the original construction or from rehabilitation under local ordinances. Unless the anchors are 6 feet on center or less, they are not considered effective in earthquakes. If they are closely spaced, and appear to be recently installed, it indicates that the building has been rehabilitated. In either case, when these anchors are present all around the building, the original construction is URM bearing wall.

4. When a building has many exterior solid walls constructed from hollow clay tile, and no columns of another material can be detected, it is probably not a URM bearing wall but probably a wood or metal frame structure with URM infill.
5. One way to distinguish a reinforced masonry building from an unreinforced masonry building is to examine the brick pattern closely. Reinforced masonry usually does not show header bricks in the wall surface.

If a building does not display the above features, or if the exterior is covered by other finish material, the building may still be URM.

E.13.2 Typical Earthquake Damage

Unreinforced masonry structures are recognized as the most hazardous structural type. They have been observed to fail in many modes during past earthquakes. Typical problems include the following.

1. **Insufficient Anchorage**—Because the walls, parapets, and cornices are not positively anchored to the floors, they tend to fall out. The collapse of bearing walls can lead to major building collapses. Some of these buildings have anchors as a part of the original construction or as a rehabilitation. These older anchors exhibit questionable performance. (See Figure E-53 for parapet damage.)



Figure E-53 Parapet failure leaving an uneven roof line, due to inadequate anchorage, 1989 Loma Prieta earthquake.

2. **Excessive Diaphragm Deflection**—Because most of the floor diaphragms are constructed of finished wood flooring placed over $\frac{3}{4}$ "-thick wood sheathing, they tend to be stiff compared with other types of wood diaphragms. This stiffness results in rotations about a vertical axis,

accompanying translations in the direction of the open front walls of buildings, due to a lack of in-plane stiffness in these open fronts. Because there is little resistance in the masonry walls for out-of-plane loading, the walls allow large diaphragm displacements and cause the failure of the walls out of their plane. Large drifts occurring at the roof line can cause a masonry wall to overturn and collapse under its own weight.

3. **Low Shear Resistance**—The mortar used in these older buildings was often made of lime and sand, with little or no cement, and had very little shear strength. The bearing walls will be heavily damaged and collapse under large loads. (See Figure E-54)



Figure E-54 Damaged URM building, 1992 Big Bear earthquake.

4. **Slender Walls** —Some of these buildings have tall story heights and thin walls. This condition, especially in non-load-bearing walls, will result in buckling out-of-plane under severe lateral load. Failure of a non-load-bearing wall represents a falling hazard, whereas the collapse of a load-bearing wall will lead to partial or total collapse of the structure.

E.13.3 Common Rehabilitation Techniques

Over the last 10 years or more, jurisdictions in California have required that unreinforced masonry bearing-wall buildings be rehabilitated or demolished. To minimize the economical impact on owners of having to rehabilitate their buildings, many jurisdictions implemented phased programs such that the critical items were dealt with first. The following are the key elements included in a typical rehabilitation program.

1. Roof and floor diaphragms are connected to the walls for both anchorage forces (out of the plane of the wall) and shear forces (in the plane of the

wall). Anchorage connections are placed at 6 feet spacing or less, depending on the force requirements. Shear connections are usually placed at around 2 feet center to center. Anchors consist of bolts installed through the wall, with 6-inch-square washer plates, and connected to hardware attached to the wood framing. Shear connections usually are bolts embedded in the masonry walls in oversized holes filled with either a non-shrink grout or an epoxy adhesive. See Figure E-55.

2. In cases when the height to thickness ratio of the walls exceeds the limits of stability, rehabilitation consists of reducing the spans of the wall to a level that their thickness can support. Parapet rehabilitation consists of reducing the parapet to what is required for fire safety and then bracing from the top to the roof.
3. If the building has an open storefront in the first story, resulting in a soft story, part of the storefront is enclosed with new masonry or a steel frame is provided there, with new foundations.
4. Walls are rehabilitated by either closing openings with reinforced masonry or with reinforced gunite.



Figure E-55 Upper: Two existing anchors above three new wall anchors at floor line using decorative washer plates. Lower: Rehabilitation techniques include closely spaced anchors at floor and roof levels.

Appendix F

Earthquakes and How Buildings Resist Them

F.1 The Nature of Earthquakes

In a global sense, earthquakes result from motion between plates comprising the earth's crust (see Figure F-1). These plates are driven by the convective motion of the material in the earth's mantle between the core and the crust, which in turn is driven by heat generated at the earth's core. Just as in a heated pot of water, heat from the earth's core causes material to rise to the earth's surface. Forces between the rising material and the earth's crustal plates cause the plates to move. The resulting relative motions of the plates are associated with the generation of earthquakes. Where the plates spread apart, molten material fills the void. An example is the ridge on the ocean floor, at the middle of the Atlantic

Ocean. This material quickly cools and, over millions of years, is driven by newer, viscous, fluid material across the ocean floor.

These large pieces of the earth's surface, termed tectonic plates, move very slowly and irregularly. Forces build up for decades, centuries, or millennia at the interfaces (or faults) between plates, until a large releasing movement suddenly occurs. This sudden, violent motion produces the nearby shaking that is felt as an earthquake. Strong shaking produces strong horizontal forces on structures, which can cause direct damage to buildings, bridges, and other man-made structures as well as triggering fires, landslides, road damage, tidal waves (tsunamis) and other damaging phenomena.

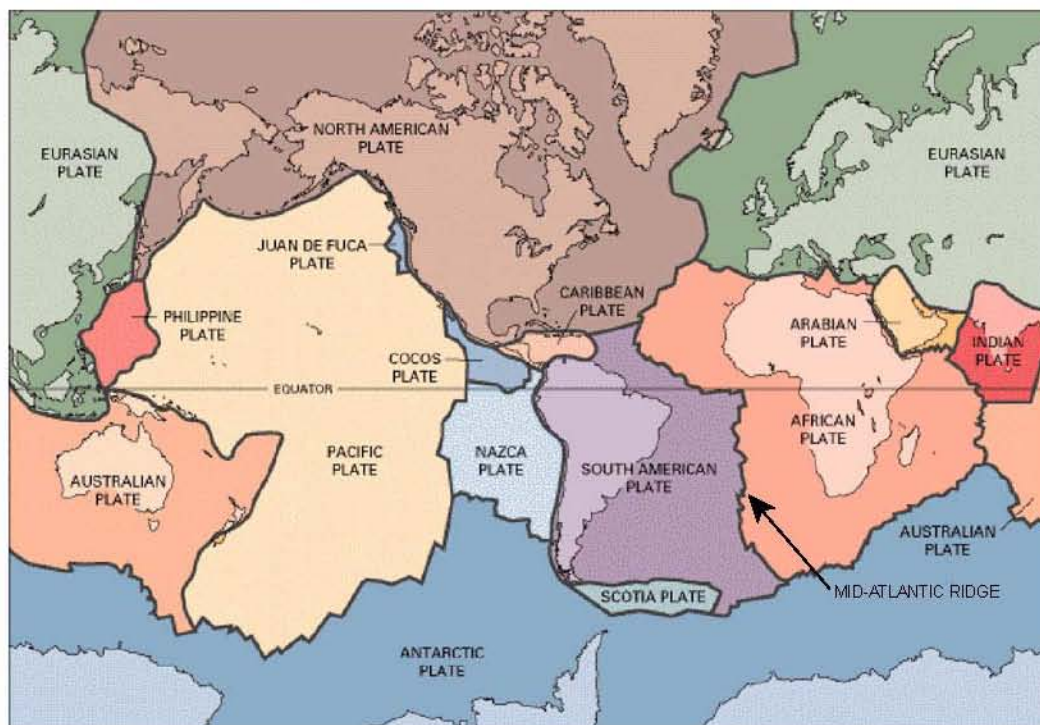

Figure F-1 The separate tectonic plates comprising the earth's crust superimposed on a map of the world.

A fault is like a “tear” in the earth’s crust and its fault surface may be from one to over one hundred miles deep. In some cases, faults are the physical expression of the boundary between adjacent tectonic plates and thus are hundreds of miles long. In addition, there are shorter faults, parallel to, or branching out from, a main fault zone. Generally, the longer a fault, the larger magnitude earthquake it can generate. Beyond the main tectonic plates, there are many smaller sub-plates, “platelets” and simple blocks of crust which can move or shift due to the “jostling” of their neighbors and the major plates. The known existence of these many sub-plates implies that smaller but still damaging earthquakes are possible almost anywhere.

With the present understanding of the earthquake generating mechanism, the times, sizes and locations of earthquakes cannot be reliably predicted. Generally, earthquakes will be concentrated in the vicinity of faults, and certain faults are more likely than others to produce a large event, but the earthquake generating process is not understood well enough to predict the exact time of earthquake occurrence. Therefore, communities must be prepared for an earthquake to occur at any time.

Four major factors can affect the severity of ground shaking and thus potential damage at a site. These are the magnitude of the earthquake, the type of earthquake, the distance from the source of the earthquake to the site, and the hardness or softness of the rock or soil at the site. Larger earthquakes will shake longer and harder, and thus cause more damage. Experience has shown that the ground motion can be felt for several seconds to a minute or longer. In preparing for earthquakes, both horizontal (side to side) and vertical shaking must be considered.

There are many ways to describe the size and severity of an earthquake and associated ground shaking. Perhaps the most familiar are earthquake magnitude and Modified Mercalli Intensity (MMI, often simply termed “intensity”). Earthquake magnitude is technically known as the Richter magnitude, a numerical description of the maximum amplitude of ground movement measured by a seismograph (adjusted to a standard setting). On the Richter scale, the largest recorded earthquakes have had magnitudes of about 8.5. It is a logarithmic scale, and a unit increase in magnitude corresponds to a ten-fold increase in the adjusted ground displacement amplitude, and to approximately a thirty-fold increase in total potential strain energy released by the earthquake.

Modified Mercalli Intensity (MMI) is a subjective scale defining the level of shaking at specific sites on a scale of I to XII. (MMI is expressed in

Roman numerals, to connote its approximate nature.) For example, slight shaking that causes few instances of fallen plaster or cracks in chimneys constitutes MMI VI. It is difficult to find a reliable precise relationship between magnitude, which is a description of the earthquake’s total energy level, and intensity, which is a subjective description of the level of shaking of the earthquake at specific sites, because shaking intensity can vary with earthquake magnitude, soil type, and distance from the event.

The following analogy may be worth remembering: earthquake magnitude and intensity are similar to a light bulb and the light it emits. A particular light bulb has only one energy level, or wattage (e.g., 100 watts, analogous to an earthquake’s magnitude). Near the light bulb, the light intensity is very bright (perhaps 100 foot-candles, analogous to MMI IX), while farther away the intensity decreases (e.g., 10 foot-candles, MMI V). A particular earthquake has only one magnitude value, whereas it has intensity values that differ throughout the surrounding land.

MMI is a subjective measure of seismic intensity at a site, and cannot be measured using a scientific instrument. Rather, MMI is estimated by scientists and engineers based on observations, such as the degree of disturbance to the ground, the degree of damage to typical buildings and the behavior of people. A more objective measure of seismic shaking at a site, which can be measured by instruments, is a simple structure’s acceleration in response to the ground motion. In this *Handbook*, the level of ground shaking is described by the spectral response acceleration.

F.2 Seismicity of the United States

Maps showing the locations of earthquake epicenters over a specified time period are often used to characterize the seismicity of given regions. Figures F-2, F-3, and F-4 show the locations of earthquake epicenters⁴ in the conterminous United States, Alaska, and Hawaii, respectively, recorded during the time period, 1977-1997. It is evident from Figures F-2 through F-4 that some parts of the country have experienced more earthquakes than others. The boundary between the North American and Pacific tectonic plates lies along the west coast of the United States and south of Alaska. The San Andreas fault in California and the Aleutian Trench off the coast of Alaska are part of this boundary. These active seismic zones have generated earthquakes with Richter

⁴An epicenter is defined as the point on the earth’s surface beneath which the rupture process for a given earthquake commenced.

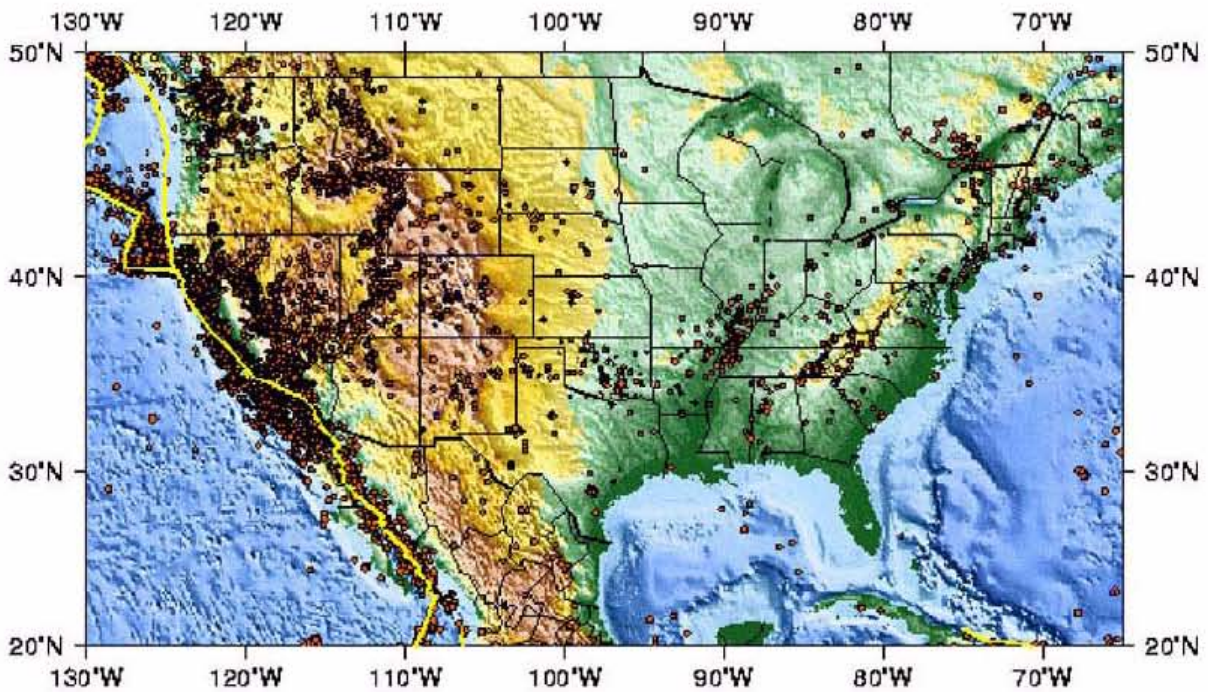

Figure F-2 Seismicity of the conterminous United States 1977 – 1997 (from the website at <http://neic.usgs.gov/neis/general/seismicity/us.html>). This reproduction shows earthquake locations without regard to magnitude or depth. The San Andreas fault and other plate boundaries are indicated with white lines.

magnitudes greater than 8. There are many other smaller fault zones throughout the western United States that are also participating intermittently in releasing the stresses and strains that are built up as the tectonic plates try to move past one another. Because earthquakes always occur along faults, the seismic hazard will be greater for those population centers close to active fault zones.

In California the earthquake hazard is so significant that special study zones have been created by the legislature, and named Alquist-Priola Special Study Zones. These zones cover the larger known faults and require special geotechnical studies to be performed in order to establish design parameters.

On the east coast of the United States, the sources of earthquakes are less understood. There is no plate boundary and few locations of faults are known. Therefore, it is difficult to make statements about where earthquakes are most likely to occur. Several significant historical earthquakes have occurred, such as in Charleston, South Carolina, in 1886 and New Madrid, Missouri, in 1811 and 1812, indicating that there is potential for large earthquakes. However, most earthquakes in the eastern United States are smaller magnitude events. Because

of regional geologic differences, specifically, the hardness of the crustal rock, eastern and central U.S. earthquakes are felt at much greater distances from their sources than those in the western United States, sometimes at distances up to a thousand miles.

F.3 Earthquake Effects

Many different types of damage can occur in buildings. Damage can be divided into two categories: structural and nonstructural, both of which can be hazardous to building occupants. Structural damage means degradation of the building's structural support systems (i.e., vertical- and lateral-force-resisting systems), such as the building frames and walls. Nonstructural damage refers to any damage that does not affect the integrity of the structural support systems. Examples of nonstructural damage are chimneys collapsing, windows breaking, or ceilings falling. The type of damage to be expected is a complex issue that depends on the structural type and age of the building, its configuration, construction materials, the site conditions, the proximity of the building to neighboring buildings, and the type of non-structural elements.

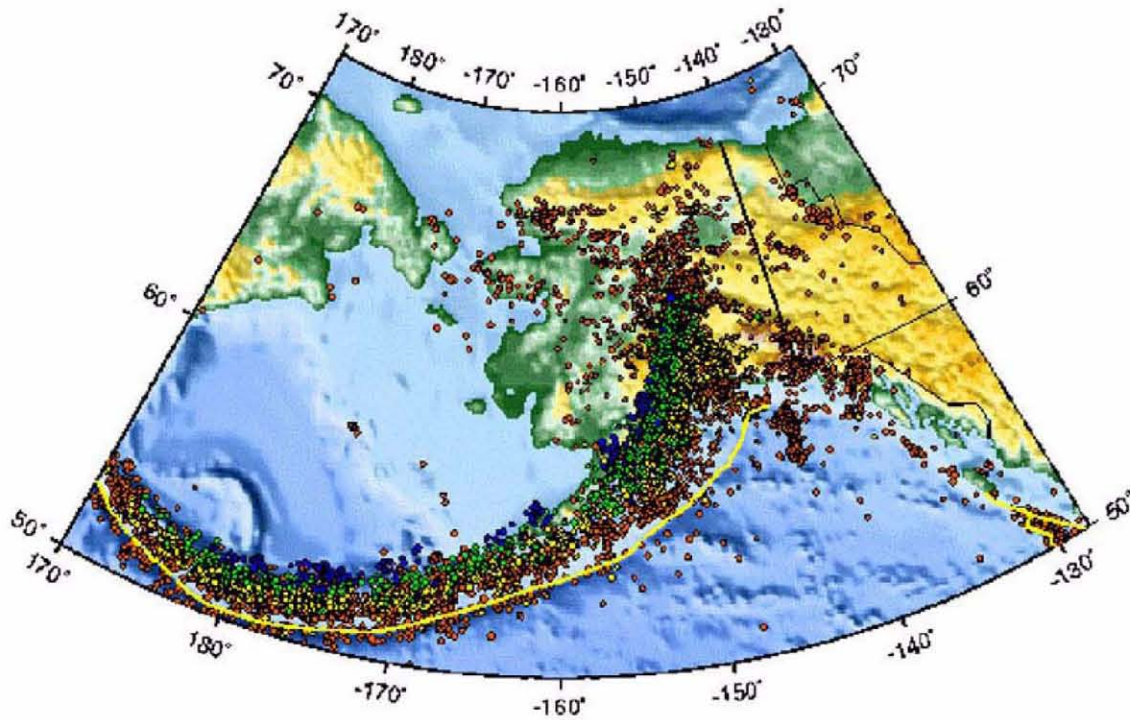

Figure F-3 Seismicity of Alaska 1977 – 1997. The white line close to most of the earthquakes is the plate boundary, on the ocean floor, between the Pacific and North America plates.

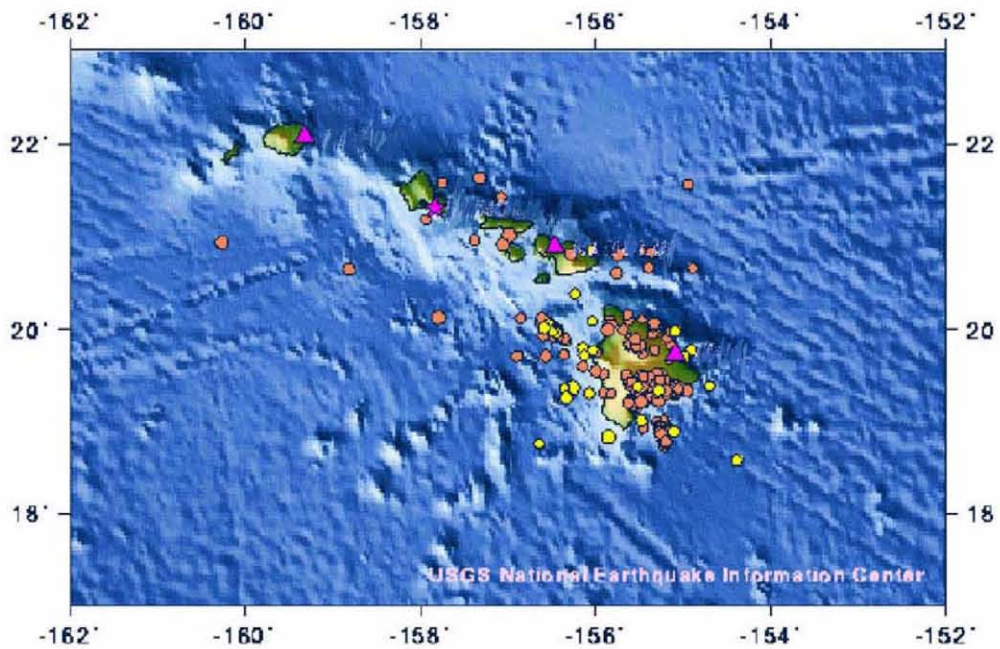

Figure F-4 Seismicity of Hawaii 1977 – 1997. See Figure F-2 caption.

When strong earthquake shaking occurs, a building is thrown mostly from side to side, and also up and down. That is, while the ground is violently moving from side to side, taking the building foundation with it, the building structure tends to stay at rest, similar to a passenger standing on a bus that accelerates quickly. Once the building starts moving, it tends to continue in the same direction, but the ground moves back in the opposite direction (as if the bus driver first accelerated quickly, then suddenly braked). Thus the building gets thrown back and forth by the motion of the ground, with some parts of the building lagging behind the foundation movement, and then moving in the opposite direction. The force F that an upper floor level or roof level of the building should successfully resist is related to its mass m and its acceleration a , according to Newton's law, $F = ma$. The heavier the building the more the force is exerted. Therefore, a tall, heavy, reinforced-concrete building will be subject to more force than a lightweight, one-story, wood-frame house, given the same acceleration.

Damage can be due either to structural members (beams and columns) being overloaded or differential movements between different parts of the structure. If the structure is sufficiently strong to resist these forces or differential movements, little damage will result. If the structure cannot resist these forces or differential movements, structural members will be damaged, and collapse may occur.

Building damage is related to the duration and the severity of the ground shaking. Larger earthquakes tend to shake longer and harder and therefore cause more damage to structures. Earthquakes with Richter magnitudes less than 5 rarely cause significant damage to buildings, since acceleration levels (except when the site is on the fault) and duration of shaking for these earthquakes are relatively small.

In addition to damage caused by ground shaking, damage can be caused by buildings pounding against one another, ground failure that causes the degradation of the building foundation, landslides, fires and tidal waves (tsunamis). Most of these "indirect" forms of damage are not addressed in this *Handbook*.

Generally, the farther from the source of an earthquake, the less severe the motion. The rate at which motion decreases with distance is a function of the regional geology, inherent characteristics and details of the earthquake, and its source location. The underlying geology of the site can also have a significant effect on the amplitude of the ground motion there. Soft, loose soils tend to amplify the ground motion and in many cases a resonance effect can make it last longer. In such circumstances, building damage can be accentuated. In the San Francisco

earthquake of 1906, damage was greater in the areas where buildings were constructed on loose, man-made fill and less at the tops of the rocky hills. Even more dramatic was the 1985 Mexico City earthquake. This earthquake occurred 250 miles from the city, but very soft soils beneath the city amplified the ground shaking enough to cause weak mid-rise buildings to collapse (see Figure F-5). Resonance of the building frequency with the amplified ground shaking frequency played a significant role. Sites with rock close to or at the surface will be less likely to amplify motion. The type of motion felt also changes with distance from the earthquake. Close to the source the motion tends to be violent rapid shaking, whereas farther away the motion is normally more of a swaying nature. Buildings will respond differently to the rapid shaking than to the swaying motion.

Each building has its own vibrational characteristics that depend on building height and structural type. Similarly, each earthquake has its own vibrational characteristics that depend on the geology of the site, distance from the source, and the type and site of the earthquake source mechanism. Sometimes a natural resonant frequency of the building and a prominent frequency of the earthquake motion are similar and cause a sympathetic response, termed resonance. This causes an increase in the amplitude of the building's vibration and consequently increases the potential for damage.

Resonance was a major problem in the 1985 Mexico City earthquake, in which the total collapse of many mid-rise buildings (Figure F-5) caused many fatalities. Tall buildings at large distances from the earthquake source have a small, but finite, probability of being subjected to ground motions containing frequencies that can cause resonance.

Where taller, more flexible, buildings are susceptible to distant earthquakes (swaying motion) shorter



Figure F-5 Mid-rise building collapse, 1985 Mexico City earthquake.



Figure F-6 Near-field effects, 1992 Landers earthquake, showing house (white arrow) close to surface faulting (black arrow); the insert shows a house interior.

and stiffer buildings are more susceptible to nearby earthquakes (rapid shaking). Figure F-6 shows the effects on shorter, stiffer structures that are close to the source. The inset picture shows the interior of the house. Accompanying the near field effects is surface faulting also shown in Figure F-6.

The level of damage that results from a major earthquake depends on how well a building has been designed and constructed. The exact type of damage cannot be predicted because no two buildings undergo identical motion. However, there are some general trends that have been observed in many earthquakes.

- Newer buildings generally sustain less damage than older buildings designed to earlier codes.
- Common problems in wood-frame construction are the collapse of unreinforced chimneys (Figure F-7) houses sliding off their foundations (Figure F-8), collapse of cripple walls (Figure F-9), or collapse of post and pier foundations (Figure F-10). Although such damage may be costly to repair, it is not usually life threatening.
- The collapse of load bearing walls that support an entire structure is a common form of damage in unreinforced masonry structures (Figure F-11).



Figure F-7 Collapsed chimney with damaged roof, 1987 Whittier Narrows earthquake.

- Similar types of damage have occurred in many older tilt-up buildings (Figure F-12).

From a life-safety perspective, vulnerable buildings need to be clearly identified, and then strengthened or demolished.

F.4 How Buildings Resist Earthquakes

As described above, buildings experience horizontal distortion when subjected to earthquake motion. When these distortions get large, the damage can be catastrophic. Therefore, most buildings are designed



Figure F-8 House that slid off foundation, 1994 Northridge earthquake.



Figure F-9 Collapsed cripple stud walls dropped this house to the ground, 1992 Landers and Big Bear earthquakes.



Figure F-10 This house has settled to the ground due to collapse of its post and pier foundation.



Figure F-11 Collapse of unreinforced masonry bearing wall, 1933 Long Beach earthquake.



Figure F-12 Collapse of a tilt-up bearing wall.

with lateral-force-resisting systems (or seismic systems), to resist the effects of earthquake forces. In many cases seismic systems make a building stiffer against horizontal forces, and thus minimize the amount of relative lateral movement and consequently the damage. Seismic systems are usually designed to resist only forces that result from horizontal ground motion, as distinct from vertical ground motion.

The combined action of seismic systems along the width and length of a building can typically resist earthquake motion from any direction. Seismic systems differ from building to building because the type of system is controlled to some extent by the basic layout and structural elements of the building. Basically, seismic systems consist of axial-, shear- and bending-resistant elements.

In wood-frame, stud-wall buildings, plywood siding is typically used to prevent excessive lateral deflection in the plane of the wall. Without the extra strength provided by the plywood, walls would distort excessively or “rack,” resulting in broken windows and stuck doors. In older wood frame houses,

this resistance to lateral loads is provided by either wood or steel diagonal bracing.

The earthquake-resisting systems in modern steel buildings take many forms. In moment-resisting steel frames, the connections between the beams and the columns are designed to resist the rotation of the column relative to the beam. Thus, the beam and the column work together and resist lateral movement and lateral displacement by bending. Steel frames sometimes include diagonal bracing configurations, such as single diagonal braces, cross-bracing and “K-bracing.” In braced frames, horizontal loads are resisted through tension and compression forces in the braces with resulting changed forces in the beams and columns. Steel buildings are sometimes con-

structed with moment-resistant frames in one direction and braced frames in the other.

In concrete structures, shear walls are sometimes used to provide lateral resistance in the plane of the wall, in addition to moment-resisting frames. Ideally, these shear walls are continuous reinforced-concrete walls extending from the foundation to the roof of the building. They can be exterior walls or interior walls. They are interconnected with the rest of the concrete frame, and thus resist the horizontal motion of one floor relative to another. Shear walls can also be constructed of reinforced masonry, using bricks or concrete blocks.

References

- ASCE, 1998, *Handbook for the Seismic Evaluation of Buildings — A Pre-standard*, prepared by the American Society of Civil Engineers for the Federal Emergency Management Agency, FEMA 310 Report, Washington D.C.
- ASCE, 2000, *Prestandard and Commentary for the Seismic Rehabilitation of Buildings*, prepared by the American Society of Civil Engineers for the Federal Emergency Management Agency, FEMA 356 Report, Washington, D.C.
- ATC, 1987, *Evaluating the Seismic Resistance of Existing Buildings*, Applied Technology Council, ATC-14 Report, Redwood City, California.
- ATC, 1989, *Procedures for Postearthquake Safety Evaluation of Buildings*, Applied Technology Council, ATC-20 Report, Redwood City, California.
- ATC, 1992, *Procedures for Building Seismic Rehabilitation (Interim)*, Applied Technology Council, ATC-26-4 Report, Redwood City, California
- ATC, 1995, *Addendum to the ATC-20 Postearthquake Building Safety Procedures* Applied Technology Council, ATC-20-2 Report, Redwood City, California.
- ATC, 1988a, *Rapid Visual Screening of Buildings for Potential Seismic Hazards: A Handbook*, prepared by the Applied Technology Council for the Federal Emergency Management Agency, FEMA 154 Report, Washington, D.C.
- ATC, 1988b, *Rapid Visual Screening of Buildings for Potential Seismic Hazards: Supporting Documentation*, prepared by the Applied Technology Council for the Federal Emergency Management Agency, FEMA 155 Report, Washington, D.C.
- ATC, 1997a, *NEHRP Guidelines for the Seismic Rehabilitation of Buildings*, prepared by the Applied Technology Council for the Building Seismic Safety Council, published by the Federal Emergency Management Agency, FEMA 273 Report, Washington, D.C.
- ATC, 1997b, *NEHRP Commentary on the Guidelines for the Seismic Rehabilitation of Buildings*, prepared by the Applied Technology Council for the Building Seismic Safety Council, published by the Federal Emergency Management Agency, FEMA 274 Report, Washington, D.C.
- ATC, 2002, *Rapid Visual Screening of Buildings for Potential Seismic Hazards: Supporting Documentation (2nd edition)*, prepared by the Applied Technology Council for the Federal Emergency Management Agency, FEMA 155 Report, Washington, D.C.
- BSSC, 1992, *NEHRP Handbook for the Seismic Evaluation of Existing Buildings*, prepared by the Building Seismic Safety Council for the Federal Emergency Management Agency, FEMA 178 Report, Washington D.C.
- BSSC, 1997, *NEHRP Recommended Provisions for the Seismic Regulations for New Buildings and Other Structures, and Commentary*, prepared by the Building Seismic Safety Council for the Federal Emergency Management Agency, FEMA 302 and 303 Reports, Washington, D.C.
- BSSC, 2000, *NEHRP Recommended Provisions for the Seismic Regulations for New Buildings and Other Structures, and Commentary, 2000 Edition*, prepared by the Building Seismic Safety Council for the Federal Emergency Management Agency, FEMA 368 and 369 Reports, Washington, D.C.
- EERI, 1998, *Seismic Rehabilitation of Buildings: Strategic Plan 2005*, prepared by the Earthquake Engineering Research Institute for the Federal Emergency Management Agency, FEMA 315 Report, Washington, D.C.
- FEMA, 1995, *Typical Costs for Seismic Rehabilitation of Buildings, Second Edition*, FEMA 156 and 157 Reports, Federal

- Emergency Management Agency,
Washington, D.C.
- ICBO, 1973, 1997, *Uniform Building Code*,
International Conference of Building Officials,
Whittier, California.
- NBS, 1980, *Development of a Probability Based
Load Criterion for American National
Standard A58.1*, NBS Special Publication 577,
National Bureau of Standards, Washington,
D.C.
- NIBS, 1999, *Earthquake Loss Estimation
Methodology HAZUS, Technical Manual*,
Vol. 1, prepared by the National Institute of
Building Sciences for the Federal Emergency
Management Agency, Washington, D.C.
- ROA, 1998, *Planning for Seismic Rehabilitation:
Societal Issues*, developed for the Building
Seismic Safety Council, by Robert Olson
Associates, Inc., for the Federal Emergency
Management Agency, FEMA-275 Report,
Washington, D.C.
- SAC, 2000, *Recommended Seismic Design
Criteria for New Steel Moment-Frame
Buildings*, prepared by the SAC Joint Venture,
a partnership of the Structural Engineers
Association of California, the Applied
Technology Council, and California
Universities for Research in Earthquake
Engineering, for the Federal Emergency
Management Agency, FEMA 350 Report,
Washington, D.C.
- VSP, 1994, *Seismic Rehabilitation of Federal
Buildings: A Benefit/Cost Model; Volume 1: A
Users Manual and Volume 2: Supporting
Documentation*; prepared by VSP Associates,
Sacramento California, for the Federal
Emergency Management Agency, FEMA-255
and FEMA-256 Reports, Washington, D.C.
- Web pages
- Sanborn Map Company
www.sanbornmap.com
www.lib.berkeley.edu/EART/sanborn.html

Project Participants

Project Management

Mr. Christopher Rojahn (Principal Investigator)
Applied Technology Council
555 Twin Dolphin Drive, Suite 550
Redwood City, California 94065

Dr. Charles Scawthorn (Co-Principal
Investigator and Project Director)
ABS Consulting
1111 Broadway, 10th Floor
Oakland, California 94607

FEMA Management

Mr. Ugo Morelli
Federal Emergency Management Agency
500 C Street, Room 416
Washington, DC 20472

Project Advisory Panel

Prof. Thalia Anagnos
(San Jose State University)
2631 South Court
Palo Alto, California 94306

Prof. Anne S. Kiremidjian
(Stanford University)
1421 Berry Hills Court,
Los Altos, California 94305

Mr. John Baals, Seismic Safety Program
Coordinator, U.S. Department of the Interior
Bureau of Reclamation
Denver Federal Center, Building 67
P.O. Box 25007, D-8110
Denver, Colorado 80225-0007

Ms. Joan MacQuarrie
Chief Building Official
City of Berkeley
2120 Milvia Street
Berkeley, California 94704

Mr. James Cagley*
Cagley & Associates
6141 Executive Blvd.
Rockville, Maryland 20852

Mr. Chris D. Poland
Degenkolb Engineers
225 Bush Street, Suite 1000
San Francisco, California 94104

Mr. Melvyn Green
Melvyn Green & Associates
21307 Hawthorne Blvd., Suite 250
Torrance, California 90503

Prof. Lawrence D. Reaveley
(University of Utah)
1702 Cannes Way
Salt Lake City, Utah 84121

Mr. Terry Hughes, CBO
Code Specialist
Hnedak Bobo Group, Inc.
104 South Front Street
Memphis, Tennessee 38103

Mr. Doug Smits
Chief Building/Fire Official
City of Charleston
75 Calhoun Street, Division 320
Charleston, South Carolina 29401

Mr. Ted Winstead
Winstead Engineering, Inc.
2736 Gerald Ford Drive, East
Cordova, Tennessee 38016

*ATC Board Contact

Technical Consultants

Mr. Kent David
ABS Consulting
1111 Broadway, 10th Floor
Oakland, California 94607-5500

Mr. Richard Ranous
ABS Consulting
300 Commerce Drive, Suite 200
Irvine, California 92602

Dr. Stephanie A. King
Weidlinger Associates
4410 El Camino Real, Suite 110
Los Altos, California 94022

Dr. Nilesh Shome
ABS Consulting
1111 Broadway, 10th Floor
Oakland, California 94607-5500

Mr. Vincent Prabis
ABS Consulting
1111 Broadway, 10th Floor
Oakland, California 94607-5500

Workshop Consultants

Mr. William Holmes (Facilitator)
Rutherford & Chekene
427 Thirteenth Street
Oakland, California 94612

Dr. Keith Porter (Recorder)
California Institute of Technology
1200 E. California Blvd., MC 104-44
Pasadena, California 91125

Report Production and Editing

Dr. Gerald Brady
Applied Technology Council
555 Twin Dolphin Drive, Suite 550
Redwood City, California 94065

Ms. Michelle Schwartzbach
Applied Technology Council
555 Twin Dolphin Drive, Suite 550
Redwood City, California 94065

Mr. Peter Mork
Applied Technology Council
555 Twin Dolphin Drive, Suite 550
Redwood City, California 94065