



of the National Institute of Building Sciences

*Program on
Improved Seismic Safety
Provisions*

2003 Edition

**NEHRP RECOMMENDED PROVISIONS
FOR SEISMIC REGULATIONS
FOR NEW BUILDINGS
AND OTHER STRUCTURES (FEMA 450)**

Part 1: Provisions

The **Building Seismic Safety Council (BSSC)** was established in 1979 under the auspices of the National Institute of Building Sciences as an entirely new type of instrument for dealing with the complex regulatory, technical, social, and economic issues involved in developing and promulgating building earthquake hazard mitigation regulatory provisions that are national in scope. By bringing together in the BSSC all of the needed expertise and all relevant public and private interests, it was believed that issues related to the seismic safety of the built environment could be resolved and jurisdictional problems overcome through authoritative guidance and assistance backed by a broad consensus.

The BSSC is an independent, voluntary membership body representing a wide variety of building community interests. Its fundamental purpose is to enhance public safety by providing a national forum that fosters improved seismic safety provisions for use by the building community in the planning, design, construction, regulation, and utilization of buildings.

See the back of the *Commentary* volume for a full description of BSSC activities.

2003 BSSC BOARD OF DIRECTION

Chairman	Charles Thornton, Chairman/Principal, Thornton-Tomasetti Group, Inc., New York, New York
Vice Chairman	David Bonneville, Degenkolb Engineers, San Francisco, California
Secretary	Charles Carter, Chief Structural Engineer, American Institute of Steel Construction, Chicago, Illinois
Ex-Officio	William W. Stewart, Stewart-Schaberg Architects, Clayton, Missouri (representing the American Institute of Architects)
Members	J. Gregg Borchelt, Vice President, Brick Industry Association, Reston, Virginia Edwin Dean, Nishkian Dean, Portland, Oregon Bradford K. Douglas, Director of Engineering, American Forest and Paper Association, Washington, D.C. Henry Green, Executive Director, Bureau of Construction Codes and Fire Safety, State of Michigan, Department of Labor and Economic Growth, Lansing, Michigan (representing the National Institute of Building Sciences) H.S. Lew, Senior Research Engineer, National Institute of Standards and Technology, Gaithersburg, Maryland (representing Interagency Committee on Seismic Safety in Construction) Joseph Messersmith, Coordinating Manager, Regional Code Services, Portland Cement Association, Rockville, Virginia (representing the Portland Cement Association) Jim Rinner, Project Manager II, Kitchell CEM, Sacramento, California James Rossberg, Manager, Technical Activities for the Structural Engineering Institute, American Society of Civil Engineers, Reston Virginia Jeffery Sciadone, Associate Director, of Engineering, Institute of Business and Home Safety, Tampa, Florida W. Lee Shoemaker, Director, Engineering and Research, Metal Building Manufacturers Association, Cleveland, Ohio Howard Simpson, Simpson Gumpertz and Heger, Arlington, Massachusetts (representing National Council of Structural Engineers Associations) Charles A. Spitz, Architect/Planner/Code Consultant, Wall New Jersey (representing the American Institute of Architects)
BSSC STAFF	Claret M. Heider, Vice President for BSSC Programs Bernard F. Murphy, Director, Special Projects Carita Tanner, Communications/Public Relations Manager Patricia Blasi, Administrative Assistant

NEHRP RECOMMENDED PROVISIONS
(National Earthquake Hazards Reduction Program)
FOR SEISMIC REGULATIONS
FOR NEW BUILDINGS AND
OTHER STRUCTURES (FEMA 450)

2003 EDITION

Part 1: PROVISIONS

Prepared by the
Building Seismic Safety Council
for the
Federal Emergency Management Agency

BUILDING SEISMIC SAFETY COUNCIL
NATIONAL INSTITUTE OF BUILDING SCIENCES
Washington, D.C.
2004

NOTICE: Any opinions, findings, conclusions, or recommendations expressed in this publication do not necessarily reflect the views of the Federal Emergency Management Agency. Additionally, neither FEMA nor any of its employees make any warranty, expressed or implied, nor assume any legal liability or responsibility for the accuracy, completeness, or usefulness of any information, product, or process included in this publication.

This report was prepared under Contract EMW-2001-CO-0269 between the Federal Emergency Management Agency and the National Institute of Building Sciences.

Building Seismic Safety Council activities and products are described at the end of this report. For further information, see the Council's website (www.bssconline.org) or contact the Building Seismic Safety Council, 1090 Vermont Avenue, N.W., Suite 700, Washington, D.C. 20005; phone 202-289-7800; fax 202-289-1092; e-mail bssc@nibs.org.

Copies of this report on CD Rom may be obtained from the FEMA Publication Distribution Facility at 1-800-480-2520. Limited paper copies also will be available. The report can also be downloaded in pdf form from the BSSC website at www.bssconline.org.

The National Institute of Building Sciences and its Building Seismic Safety Council caution users of these *Provisions* documents to be alert to patent and copyright concerns especially when applying prescriptive requirements

PREFACE

One of the goals of the Department of Homeland Security's Federal Emergency Management Agency (FEMA) and the National Earthquake Hazards Reduction Program (NEHRP) is to encourage design and building practices that address the earthquake hazard and minimize the resulting risk of damage and injury. Publication of the 2003 edition of the *NEHRP Recommended Provisions for Seismic Regulation of New Buildings and Other Structures* and its *Commentary* is a fitting end to the 25th year of the NEHRP and reaffirms FEMA's ongoing support to improve the seismic safety of construction in this country. Its publication marks the sixth edition in an ongoing series of updating of both the *NEHRP Recommended Provisions* and several complementary publications. FEMA was proud to sponsor the Building Seismic Safety Council for this project and we encourage the widespread dissemination and voluntary use of this state-of-the-art consensus resource document.

The 2003 edition of the *NEHRP Recommended Provisions* contains several significant changes, including: a reformatting to improve its usability; introduction of a simplified design procedure, an updating of the seismic design maps and how they are presented; a modification in the redundancy factor; the addition of ultimate strength design provisions for foundations; the addition of several new structural systems, including buckling restrained braced frames and steel plate shear walls; structures with damping systems has been moved from an appendix to a new chapter; and inclusion of new or updated material industry reference standards for steel, concrete, masonry, and wood.

The above changes are but a few of the 138 ballots submitted to the BSSC member organizations. The number of changes continues to be significant and is a testament to the level of attention being paid to this publication. This is due in large part to the role that the *NEHRP Recommended Provisions* has in the seismic requirements in the ASCE-7 Standard *Minimum Design Loads for Buildings and Other Structures* as well as both the *International Building Code* and *NFPA 5000 Code*. FEMA welcomes this increased scrutiny and the chance to work with these code organizations.

Looking ahead, FEMA is contracting with BSSC for the update process that will lead to the 2008 edition of the *NEHRP Recommended Provisions*. As is evidenced by the proposed date, this next update cycle will be expanded to a five-year effort to conclude in time to input into the next update of the ASCE-7 standard. This update will include referencing of the ASCE-7 standard to avoid duplication of effort and a significant update and revision to the *Commentary* along with the normal update of current material and the inclusion of new, state-of-the-art seismic design research results.

Finally, FEMA wishes to express its deepest gratitude for the significant efforts of the over 200 volunteer experts as well as the BSSC Board of Directors and staff who made possible the 2003 *NEHRP Provisions* documents. It is truly their efforts that make these publications a reality. Americans unfortunate enough to experience the earthquakes that will inevitably occur in this country will owe much, perhaps even their very lives, to the contributions and dedication of these individuals to the seismic safety of new buildings. Without the dedication and hard work of these men and women, this document and all it represents with respect to earthquake risk mitigation would not have been possible.

*Department of Homeland Security/
Federal Emergency Management Agency*

INTRODUCTION and ACKNOWLEDGEMENTS

Since its creation in 1978, the National Earthquake Hazard Reduction Program (NEHRP) has provided a framework for efforts to reduce the risk from earthquakes. The Building Seismic Safety Council (BSSC) is extremely proud to have been selected by the Federal Emergency Management Agency (FEMA), the lead NEHRP agency, to play a role under NEHRP in improving the seismic resistance of the built environment. Further, the BSSC is pleased to mark the occasion of its twenty-fifth anniversary with delivery to FEMA of the consensus-approved 2003 *NEHRP Recommended Provisions for Seismic Regulations for New Buildings and other Structures*, the seventh edition of this landmark publication. The *Provisions* and its accompanying *Commentary* have developed over the past quarter century into widely available, trusted, state-of-the-art seismic design resource documents with requirements that have been adapted for use in nation's model building codes and standards.

Work on the 2003 *Provisions* began in September 2001 when NIBS entered into a contract with FEMA for initiation of the BSSC 2003 *Provisions* update effort. In mid-2001, the BSSC member organization representatives and alternate representatives and the BSSC Board of Direction were asked to identify individuals to serve on the 2003 Provisions Update Committee (PUC) and its Technical Subcommittees (TSs).

The 2003 PUC and its 13 Technical Subcommittees (TS) were then established and addressed the following topics during the update effort: design criteria and analysis, foundations and geotechnical considerations, cast-in-place/precast concrete structures, masonry structures, steel structures, wood structures, mechanical-electrical systems and building equipment and architectural elements, quality assurance, low rise and residential structures, composite steel and concrete structures, energy dissipation and base isolation, and nonbuilding structures.

Early in the update effort, a series of editorial/organizational changes were made to the 2000 version of the *Provisions* to improve the document's usability and eliminate inconsistencies and duplications that had crept in over the years; this edited document was submitted to the BSSC membership for ballot in October 2001 and was then adopted as the document to which further update changes would be proposed. All draft TS and PUC proposals for change were finalized in June 2003 and approved by the BSSC Board of Direction for balloting by the BSSC member organizations. Because of time limitations, there would be no second ballot; therefore, the BSSC Board authorized the PUC to resolve, to the extent possible, comments submitted by the membership and to defer for reconsideration during the next update cycle any comments that could not be resolved in the limited time available.

Of the 138 proposals submitted to the members for ballot, 137 received the required two-thirds affirmative vote. Of those, 3 were withdrawn for reconsideration during the next update cycle and 83 required some revision in response to comments. A summary of the results of the ballot and comment resolution process are available from the BSSC upon request and will be posted on the BSSC website (www.bssconline.org).

As in the past, the 2003 *Provisions* would not now be available without the expertise, dedication, and countless hours of effort of the more than 200 dedicated volunteers who participated in the update process. The American people benefit immeasurably from their commitment to improving the seismic-

resistance of the nation's buildings. These seismic design professionals are identified in Appendix B of the *Provisions* volume with list of BSSC Board members and member organizations.

I would like to acknowledge a few individuals and groups who deserve special thanks for their contributions to this effort. As Chairman of the BSSC Board of Direction, it is my pleasure to express heartfelt appreciation to the members of the BSSC Provisions Update Committee, especially Chairman Ronald Hamburger, and to Michael Mahoney, the FEMA Project Officer. Special thanks also are due to the BSSC staff who work untiringly behind the scenes to support all the groups mentioned above and who bring the finished product forward for acceptance. Finally, I wish to thank the members of the BSSC Board of Direction who recognize the importance of this effort and provided sage advice throughout the update cycle. We are all proud of the *2003 NEHRP Recommended Provisions* and it is my pleasure to introduce them.

Charles Thornton
Chairman, BSSC Board of Direction 2001-2003

CONTENTS

Chapter 1 GENERAL PROVISIONS	1
1.1 GENERAL.....	1
1.1.1 Purpose.....	1
1.1.2 Scope and application	1
1.1.3 References.....	2
1.1.4 Definitions	3
1.1.5 Notation	3
1.2 SEISMIC USE GROUPS	4
1.2.1 Seismic Use Group III	4
1.2.2 Seismic Use Group II.....	4
1.2.3 Seismic Use Group I.....	4
1.2.4 Multiple use	4
1.2.5 Seismic Use Group III structure access protection	5
1.3 OCCUPANCY IMPORTANCE FACTOR.....	5
1.4 SEISMIC DESIGN CATEGORY	5
1.4.1 Determination of Seismic Design Category.....	5
1.4.2 Site limitation for Seismic Design Categories E and F.....	6
1.5 SEISMIC DESIGN CATEGORY A	6
1.5.1 Lateral forces	6
1.5.2 Connections	7
1.5.3 Anchorage of concrete or masonry walls.....	7
1.5.4 Tanks assigned to Seismic Use Group III.....	7
Chapter 2 QUALITY ASSURANCE	9
2.1 GENERAL	9
2.1.1 Scope.....	9
2.1.2 References.....	9
2.1.3 Definitions	9
2.1.4 Notation	11
2.2 GENERAL REQUIREMENTS.....	11
2.2.1 Details of quality assurance plan	11
2.2.2 Contractor responsibility.....	12
2.3 SPECIAL INSPECTION.....	12
2.3.1 Piers, piles, and caissons	12
2.3.2 Reinforcing steel	12
2.3.3 Structural concrete	12
2.3.4 Prestressed concrete	12
2.3.5 Structural masonry	12
2.3.6 Structural steel	12
2.3.7 Structural wood.....	13
2.3.8 Cold-formed steel	13
2.3.9 Architectural components	13
2.3.10 Mechanical and electrical components	13
2.3.11 Seismic isolation systems	14
2.4 TESTING	14
2.4.1 Reinforcing and prestressing steel	14

2.4.2 Structural concrete	14
2.4.3 Structural masonry	14
2.4.4 Structural steel	14
2.4.5 Mechanical and electrical equipment.....	14
2.4.6 Seismically isolated structures.....	14
2.5 STRUCTURAL OBSERVATIONS.....	15
2.6 REPORTING AND COMPLIANCE PROCEDURES	15
 Chapter 3 GROUND MOTION.....	 17
3.1 GENERAL.....	17
3.1.1 Scope.....	17
3.1.2 References.....	17
3.1.3 Definitions	17
3.1.4 Notation	17
3.2 GENERAL REQUIREMENTS.....	19
3.2.1 Site class	19
3.2.2 Procedure selection	19
3.3 GENERAL PROCEDURE.....	19
3.3.1 Mapped acceleration parameters.....	19
3.3.2 Site coefficients and adjusted acceleration parameters.....	19
3.3.3 Design acceleration parameters	38
3.3.4 Design response spectrum.....	38
3.4 SITE SPECIFIC PROCEDURE.....	46
3.4.1 Probabilistic maximum considered earthquake	46
3.4.2 Deterministic maximum considered earthquake.....	46
3.4.3 Site-specific maximum considered earthquake	46
3.4.4 Design response spectrum.....	47
3.5 SITE CLASSIFICATION FOR SEISMIC DESIGN	47
3.5.1 Site class definitions	47
3.5.2 Steps for classifying a site.....	49
 Chapter 4 STRUCTURAL DESIGN CRITERIA.....	 51
4.1 GENERAL.....	51
4.1.1 Scope.....	51
4.1.2 References	51
4.1.3 Definitions	51
4.1.4 Notation	53
4.2 GENERAL REQUIREMENTS.....	54
4.2.1 Design basis	54
4.2.2 Combination of load effects.....	54
4.3 SEISMIC-FORCE-RESISTING SYSTEM.....	55
4.3.1 Selection and limitations.....	55
4.3.2 Configuration	62
4.3.3 Redundancy	65
4.4 STRUCTURAL ANALYSIS	66
4.4.1 Procedure selection	66
4.4.2 Application of loading	67
4.5 DEFORMATION REQUIREMENTS	68
4.5.1 Deflection and drift limits	68
4.5.2 Seismic Design Categories B and C	68
4.5.3 Seismic Design Categories D, E, and F	68

4.6 DESIGN AND DETAILING REQUIREMENTS	69
4.6.1 Seismic design Category B	69
4.6.2 Seismic design Category C	70
4.6.3 Seismic Design Category D, E, and F.....	71
ALTERNATIVE SIMPLIFIED CHAPTER 4.....	73
Chapter 5 STRUCTURAL ANALYSIS PROCEDURES	83
5.1 GENERAL.....	83
5.1.1 Scope.....	83
5.1.2 Definitions	83
5.1.3 Notation	84
5.2 EQUIVALENT LATERAL FORCE PROCEDURE	86
5.2.1 Seismic base shear	86
5.2.2 Period determination.....	88
5.2.3 Vertical distribution of seismic forces	89
5.2.4 Horizontal shear distribution.....	90
5.2.5 Overturning.....	91
5.2.6 Drift determination and P-delta effects.....	91
5.3 RESPONSE SPECTRUM PROCEDURE.....	92
5.3.1 Modeling.....	92
5.3.2 Modes.....	92
5.3.3 Modal properties	92
5.3.4 Modal base shear.....	92
5.3.5 Modal forces, deflections and drifts.....	94
5.3.6 Modal story shears and moments.....	94
5.3.7 Design values	94
5.3.8 Horizontal shear distribution.....	95
5.3.9 Foundation overturning.....	95
5.3.10 P-delta effects.....	95
5.4 LINEAR RESPONSE HISTORY PROCEDURE.....	95
5.4.1 Modeling.....	95
5.4.2 Ground motion	95
5.4.3 Response parameters.....	96
5.5 NONLINEAR RESPONSE HISTORY PROCEDURE	96
5.5.1 Modeling.....	96
5.5.2 Ground motion and other loading	97
5.5.3 Response parameters.....	97
5.5.4 Design review	97
5.6 SOIL-STRUCTURE INTERACTION EFFECTS	98
5.6.1 General.....	98
5.6.2 Equivalent lateral force procedure	98
5.6.3 Response spectrum procedure.....	102
APPENDIX to Chapter 5, NONLINEAR STATIC PROCEDURE	105
Chapter 6, ARCHITECTURAL, MECHANICAL, AND ELECTRICAL COMPONENT DESIGN REQUIREMENTS	111
6.1 GENERAL.....	111
6.1.1 Scope.....	111
6.1.2 References	111

6.1.3 Definitions	113
6.1.4 Notation	114
6.2 GENERAL DESIGN REQUIREMENTS	115
6.2.1 Seismic Design Category	115
6.2.2 Component importance factor.....	115
6.2.3 Consequential damage	116
6.2.4 Flexibility.....	116
6.2.5 Component force transfer	116
6.2.6 Seismic forces	116
6.2.7 Seismic relative displacements	117
6.2.8 Component anchorage	117
6.2.9 Construction documents.....	118
6.3 ARCHITECTURAL COMPONENTS	118
6.3.1 Forces and displacements	119
6.3.2 Exterior nonstructural wall elements and connections.....	119
6.3.3 Out-of-plane bending	120
6.3.4 Suspended ceilings.....	120
6.3.5 Access floors.....	121
6.3.6 Partitions	121
6.3.7 General.....	122
6.3.8 Seismic drift limits for glass components	122
6.4 MECHANICAL AND ELECTRICAL COMPONENTS.....	122
6.4.1 Component period.....	124
6.4.2 Mechanical components.....	124
6.4.3 Electrical components.....	124
6.4.4 Supports and attachments	125
6.4.5 Utility and service lines	126
6.4.6 HVAC ductwork	126
6.4.7 Piping systems	126
6.4.8 Boilers and pressure vessels.....	127
6.4.9 Elevators	127
 Appendix to Chapter 6, ALTERNATIVE PROVISIONS FOR THE DESIGN OF PIPING SYSTEMS.....	 129
 Chapter 7 FOUNDATION DESIGN REQUIREMENTS.....	 133
7.1 GENERAL.....	133
7.1.1 Scope.....	133
7.1.2 References.....	133
7.1.3 Definitions	133
7.1.4 Notation	133
7.2 GENERAL DESIGN REQUIREMENTS	134
7.2.1 Foundation components	134
7.2.2 Soil capacities	134
7.2.3 Foundation load-deformation characteristics.....	134
7.3 SEISMIC DESIGN CATEGORY B.....	134
7.4 SEISMIC DESIGN CATEGORY C.....	134
7.4.1 Investigation.....	134
7.4.2 Pole-type structures.....	135
7.4.3 Foundation ties.....	135
7.4.4 Special pile requirements	135

7.5 SEISMIC DESIGN CATEGORIES D, E, AND F	136
7.5.1 Investigation	136
7.5.2 Liquefaction potential and soil strength loss.....	136
7.5.3 Foundation ties	137
7.5.4 Special pile and grade beam requirements.....	137
Appendix to Chapter 7, GEOTECHNICAL ULTIMATE STRENGTH DESIGN OF FOUNDATIONS AND FOUNDATION LOAD-DEFORMATION MODELING	141
Chapter 8 STEEL STRUCTURE DESIGN REQUIREMENTS	145
8.1 GENERAL.....	145
8.1.1 Scope.....	145
8.1.2 References.....	145
8.1.3 Definitions	145
8.1.4 Notation	146
8.2 GENERAL DESIGN REQUIREMENTS	146
8.2.1 Seismic Design Categories B and C	146
8.2.2 Seismic Design Categories D, E, and F.....	146
8.3 STRUCTURAL STEEL	146
8.3.1 Material properties for determination of required strength.....	146
8.4 COLD-FORM STEEL.....	147
8.4.1 Modifications to references.....	147
8.4.2 Light-frame walls.....	147
8.4.3 Prescriptive framing	148
8.4.4 Steel deck diaphragms	148
8.5 STEEL CABLES	148
8.6 RECOMMENDED PROVISIONS FOR BUCKLING-RESTRAINED BRACED FRAMES	148
8.6.1 Symbols	148
8.6.2 Glossary	149
8.6.3 Buckling-restrained braced frames (BRBF)	149
8.7 RECOMMENDED PROVISIONS FOR SPECIAL STEEL PLATE WALLS	155
8.7.1 Symbols	155
8.7.2 Glossary	156
8.7.3 Scope.....	156
8.7.4 Webs	156
8.7.5 Connections of webs to boundary elements.....	157
8.7.6 Horizontal and vertical boundary elements (HBE and VBE)	157
Chapter 9 CONCRETE STRUCTURE DESIGN REQUIREMENTS	159
9.1 GENERAL.....	159
9.1.1 Scope.....	159
9.1.2 References.....	159
9.1.3 General definitions.....	159
9.2 GENERAL DESIGN REQUIREMENTS	160
9.2.1 Classification of shear walls	160
9.2.2 Modifications to ACI 318	161
9.3 SEISMIC DESIGN CATEGORY B.....	164
9.3.1 Ordinary moment frames	164

9.4 SEISMIC DESIGN CATEGORY C.....	164
9.4.1 Classification of shear walls	164
9.4.2 Plain concrete.....	164
9.5 SEISMIC DESIGN CATEGORIES D, E, AND F.....	165
9.6 ACCEPTANCE CRITERIA FOR SPECIAL PRECAST STRUCTURAL WALLS BASED ON VALIDATION TESTING	165
9.6.1 Notation	165
9.6.2 Definitions	165
9.6.3 Scope and general requirements	166
9.6.4 Design procedure	166
9.6.5 Test modules	167
9.6.6 Testing agency	167
9.6.7 Test method.....	167
9.6.8 Test report	168
9.6.9 Test module acceptance criteria.....	169
9.6.10 Reference	169
 Appendix to Chapter 9, UNTOPPED PRECAST DIAPHRAGMS	 171
 Chapter 10, COMPOSITE STEEL AND CONCRETE STRUCTURE DESIGN REQUIREMENTS.....	 175
10.1 GENERAL	175
10.1.1 Scope.....	175
10.1.2 References.....	175
10.1.3 Definitions	175
10.1.4 Notation	175
10.2 GENERAL DESIGN REQUIREMENTS	175
10.3 SEISMIC DESIGN CATEGORIES B AND C	175
10.4 SEISMIC DESIGN CATEGORIES D, E, AND F.....	175
10.5 MODIFICATIONS TO AISC SEISMIC, PART II.....	175
10.5.1 Changes to nomenclature.....	175
10.5.2 Changes to definitions in the AISC Glossary	176
10.5.3 Changes to section 1-Scope	176
10.5.4 Changes to Section 2 – Referenced Specifications, Codes and Standards.....	176
10.5.5 Changes to Section 3 – Seismic Design Categories.....	176
10.5.6 Changes to Section 4 – Loads, Load Combinations and Nominal Strengths	176
10.5.7 Changes to Section 5.2 – Concrete and steel reinforcement.....	176
10.5.8 Changes to Section 6.3 – Composite Beams.....	176
10.5.9 Changes to Section 6.4 – Reinforced-Concrete-Encased Composite Columns.....	176
10.5.10 Changes to Section 6.4a – Ordinary Seismic System Requirements	177
10.5.11 Changes to Section 6.5 – Concrete-Filled Composite Columns	177
10.5.12 Changes to Section 6.5a – Concrete-Filled Composite Columns	177
10.5.13 Changes to Section 7.3 – Nominal Strength of Connections	178
10.5.14 Changes to Section 8.2 – Columns	179
10.5.15 Changes to Section 8.3 – Composite Beams	179
10.5.16 Changes to Section 8.4 – Partially Restrained (PR) Moment Connections	179

10.5.17 Changes to Section 9.3 – Beams	179
10.5.18 Changes to Section 9.4 – Moment Connections	179
10.5.19 Changes to Section 9.5 – Column-Beam Moment Ratio	180
10.5.20 Changes to Section 10.2 – Columns	180
10.5.21 Changes to Section 10.4 – Moment Connections	180
10.5.22 Changes to Section 11.4 – Moment Connections	180
10.5.23 Changes to Section 12.4 – Braces	180
10.5.24 Changes Title for Section 15.3.....	181
10.5.25 Changes Title for Section 16.3	181
10.5.26 Add New Section 15.4	181
10.5.27 Add New Section 16.4	181
Chapter 11 MASONRY STRUCTURE DESIGN REQUIREMENTS	183
11.1 GENERAL.....	183
11.1.1 Scope.....	183
11.1.2 References	183
11.2 GENERAL DESIGN REQUIREMENTS	183
11.2.1 Classification of shear walls	183
11.2.2 Modifications to ACI 530/ADCE 5/TMS 402 and ACI 530.1/ASCE 5/TMS 602.....	184
11.3 SPECIAL MOMENT FRAMES OF MASONRY	187
11.3.1 Calculation of required strength.....	187
11.3.2 Flexural yielding	187
11.3.3 Materials	187
11.3.4 Reinforcement.....	187
11.3.5 Beams.....	188
11.3.6 Columns	188
11.3.7 Beam-column intersections.....	189
11.4 GLASS-UNIT MASONRY AND MASONRY VENEER.....	192
11.4.1 Design lateral forces and displacements	191
11.4.2 Glass-unit masonry design	191
11.4.3 Masonry veneer design	191
11.5 PRESTRESSED MASONRY	191
11.5.1	191
Chapter 12 WOOD STRUCTURE DESIGN REQUIREMENTS	193
12.1 GENERAL.....	193
12.1.1 Scope.....	193
12.1.2 References.....	193
12.1.3 Definitions	194
12.1.4 Notation	195
12.2 DESIGN METHODS	195
12.2.1 Seismic Design Categories B, C, and D.....	195
12.2.2 Seismic Design Categories E and F	195
12.2.3 Modifications to AF&PA SDPWS for Seismic Design Categories B, C, and D	195
12.2.4 Modifications to AF&PA SDPWS for Seismic Design Categories E, and F.....	198
12.3 GENERAL DESIGN REQUIREMENTS FOR ENGINEERED WOOD CONSTRUCTION	203
12.3.1 Framing.....	203

12.4 CONVENTIONAL LIGHT-FRAME CONSTRUCTION	203
12.4.1 Limitations	203
12.4.2 Braced walls	209
12.4.3 Detailing requirements	211
 Chapter 13 SEISMICALLY ISOLATED STRUCTURE DESIGN	
REQUIREMENTS	215
13.1 GENERAL	215
13.1.1 Scope	215
13.1.2 Definitions	215
13.1.3 Notation	216
13.2 GENERAL DESIGN REQUIREMENTS	218
13.2.1 Occupancy importance factor	218
13.2.2 Configuration	218
13.2.3 Ground motion	218
13.2.4 Procedure selection	219
13.2.5 Isolation system	220
13.2.6 Structural system	221
13.2.7 Elements of structures and nonstructural components	221
13.3 EQUIVALENT LATERAL FORCE PROCEDURE	222
13.3.1 Deformational characteristics of the isolation system	222
13.3.2 Minimum lateral displacements	222
13.3.3 Minimum distribution of forces	224
13.3.4 Vertical distribution of forces	225
13.3.5 Drift limits	225
13.4 DYNAMIC PROCEDURES	225
13.4.1 Modeling	225
13.4.2 Description of procedures	226
13.4.3 Minimum lateral displacements and forces	227
13.4.4 Drift limits	228
13.5 DESIGN REVIEW	228
13.6 TESTING	228
13.6.1 Prototype tests	228
13.6.2 Determination of force-deflection characteristics	230
13.6.3 Test specimen adequacy	230
13.6.4 Design properties of the isolation system	230
 Chapter 14 NONBUILDING STRUCTURE DESIGN REQUIREMENTS	233
14.1 GENERAL	233
14.1.1 Scope	233
14.1.2 References	233
14.1.3 Definitions	234
14.1.4 Notation	235
14.1.5 Nonbuilding structures supported by other structures	237
14.2 GENERAL DESIGN REQUIREMENTS	237
14.2.1 Seismic Use Groups and importance factors	237
14.2.2 Ground motion	238
14.2.3 Design basis	238
14.2.4 Seismic-force-resisting system selection and limitations	238
14.2.5 Structural analysis procedure selection	241
14.2.6 Seismic weight	241

14.2.7 Rigid nonbuilding structures.....	241
14.2.8 Minimum base shear	241
14.2.9 Fundamental period	241
14.2.10 Vertical distribution of seismic forces	242
14.2.11 Deformation requirements	242
14.2.12 Nonbuilding structure classification	242
14.3 NONBUILDING STRUCTURES SIMILAR TO BUILDINGS	242
14.3.1 Electrical power generating facilities.....	242
14.3.2 Structural towers for tanks and vessels	242
14.3.3 Piers and wharves	243
14.3.4 Pipe racks	243
14.3.5 Steel storage tanks.....	243
14.4 NONBUILDING STRUCTURES NOT SIMILAR TO BUILDINGS.....	244
14.4.1 General.....	244
14.4.2 Earth retaining structures	244
14.4.3 Stacks and chimneys	244
14.4.4 Amusement structures.....	244
14.4.5 Special hydraulic structures	245
14.4.6 Secondary containment systems	245
14.4.7 Tanks and vessels.....	245
Appendix to Chapter 14 OTHER NONBUILDING STRUCTURES	261
Chapter 15 STRUCTURES WITH DAMPING SYSTEMS	263
15.1 GENERAL.....	263
15.1.1 Scope.....	263
15.1.2 Definitions	263
15.1.3 Notation	264
15.2 GENERAL DESIGN REQUIREMENTS	267
15.2.1 Seismic Design Category A	267
15.2.2 System requirements.....	268
15.2.3 Ground motion	278
15.2.4 Procedure selection	269
15.2.5 Damping system.....	269
15.3 NONLINEAR PROCEDURES	270
15.3.1 Nonlinear response history procedure.....	270
15.3.2 Nonlinear static procedure	271
15.4 RESPONSE SPECTRUM PROCEDURE.....	271
15.4.1 Modeling	271
15.4.2 Seismic-force-resisting system	271
15.4.3 Damping system	273
15.5 EQUIVALENT LATERAL FORCE PROCEDURE	274
15.5.1 Modeling	274
15.5.2 Seismic-force-resisting system	274
15.5.3 Damping system	277
15.6 DAMPED RESPONSE MODIFICATION	279
15.6.1 Damping coefficient	279
15.6.2 Effective damping	279
15.6.3 Effective ductility demand	281
15.6.4 Maximum effective ductility demand	282
15.7 SEISMIC LOAD CONDITIONS AND ACCEPTANCE CRITERIA	282

15.7.1 Nonlinear procedures	282
15.7.2 Seismic-force-resisting system	283
15.7.3 Damping system.....	283
15.8 DESIGN REVIEW	286
15.9 TESTING.....	286
15.9.1 Prototype tests.....	286
15.9.2 Production testing	288
Appendix A DIFFERENCES BETWEEN THE 2000 AND THE 2003 EDITIONS OF THE <i>NEHRP RECOMMENDED PROVISIONS</i>	289
Appendix B PARTICIPANTS IN THE BSSC 2003 <i>PROVISIONS</i> UPDATE PROGRAM.....	309

Chapter 1

GENERAL PROVISIONS

1.1 GENERAL

1.1.1 Purpose. The *NEHRP Recommended Provisions for Seismic Regulations for New Buildings and Other Structures* (referred to hereinafter as the *Provisions*) present criteria for the design and construction of structures to resist earthquake ground motions. The purposes of these *Provisions* are as follows:

1. To provide minimum design criteria for structures appropriate to their primary function and use considering the need to protect the health, safety, and welfare of the general public by minimizing the earthquake-related risk to life and
2. To improve the capability of essential facilities and structures containing substantial quantities of hazardous materials to function during and after design earthquakes.

The design earthquake ground motion levels specified herein could result in both structural and nonstructural damage. For most structures designed and constructed according to these *Provisions*, structural damage from the design earthquake ground motion would be repairable although perhaps not economically so. For essential facilities, it is expected that the damage from the design earthquake ground motion would not be so severe as to preclude continued occupancy and function of the facility. The actual ability to accomplish these goals depends upon a number of factors including the structural framing type, configuration, materials, and as-built details of construction. For ground motions larger than the design levels, the intent of these *Provisions* is that there be a low likelihood of structural collapse.

1.1.2 Scope and application

1.1.2.1 Scope. These *Provisions* shall apply to the design and construction of structures—including additions, changes of use, and alterations—to resist the effects of earthquake motions. Every structure, and portion thereof, shall be designed and constructed to resist the effects of earthquake motions as prescribed by these *Provisions*.

Exceptions:

1. Detached one- and two-family dwellings in Seismic Design Category A, B, or C (as defined in Sec. 1.4) are exempt from all requirements of these *Provisions*.
2. Detached one- and two-family wood-frame dwellings that are designed and constructed in accordance with the conventional light-frame construction requirements in Sec. 12.5 are exempt from all other requirements of these *Provisions*.
3. Agricultural storage structures intended only for incidental human occupancy are exempt from all requirements of these *Provisions*.
4. Structures located within those regions of Figures 3.3-1 through 3.3-14 of these *Provisions* having S_S less than or equal to 0.15 and S_I less than or equal to 0.04 and structures assigned to Seismic Design Category A shall only be required to comply with Sec. 1.5 of these *Provisions*.

1.1.2.2 Additions. Additions shall be designed and constructed in accordance with the following:

1.1.2.2.1. An addition that is structurally independent from an existing structure shall be designed and constructed as required for a new structure in accordance with Sec. 1.1.2.1.

1.1.2.2.2. An addition that is not structurally independent from an existing structure shall be designed and constructed such that the entire structure complies with the seismic-force-resistance requirements for new structures unless all of the following conditions are satisfied:

1. The addition complies with the requirements for new structures, and
2. The addition does not increase the seismic forces in any structural element of the existing structure by more than 5 percent, unless the capacity of the element subject to the increased forces is still in compliance with these *Provisions*, and
3. The addition does not decrease the seismic resistance of any structural element of the existing structure to less than that required for a new structure.

1.1.2.3 Change of use. Where a change of use results in a structure being reclassified to a higher Seismic Use Group, the structure shall comply with the requirements of Section 1.1.2.1 for a new structure.

Exception: Where a change of use results in a structure being reclassified from Seismic Use Group I to Seismic Use Group II, compliance with these *Provisions* is not required if the structure is located where S_{DS} is less than 0.3.

1.1.2.4 Alterations. Alterations are permitted to be made to any structure without requiring the structure to comply with these *Provisions* provided the alterations comply with the requirements for a new structure. Alterations that increase the seismic force in any existing structural element by more than 5 percent or decrease the design strength of any existing structural element to resist seismic forces by more than 5 percent shall not be permitted unless the entire seismic-force-resisting system is determined to comply with these *Provisions* for a new structure. All alterations shall comply with these *Provisions* for a new structure.

Exception: Alterations to existing structural elements or additions of new structural elements that are not required by these *Provisions* and are initiated for the purpose of increasing the strength or stiffness of the seismic-force-resisting system of an existing structure need not be designed for forces in accordance with these *Provisions* provided that an engineering analysis is submitted indicating the following:

1. The design strengths of existing structural elements required to resist seismic forces is not reduced,
2. The seismic force to required existing structural elements is not increased beyond their design strength,
3. New structural elements are detailed and connected to the existing structural elements as required by these *Provisions*, and
4. New or relocated nonstructural elements are detailed and connected to existing or new structural elements as required by these *Provisions*.

1.1.2.5 Alternate materials and alternate means and methods of construction. Alternate materials and alternate means and methods of construction to those prescribed in these *Provisions* are permitted if approved by the authority having jurisdiction. Substantiating evidence shall be submitted demonstrating that the proposed alternate, for the purpose intended, will be at least equal in strength, durability, and seismic resistance.

1.1.3 References. The following reference document shall be used for loads other than earthquakes and for combinations of loads as indicated in this chapter:

ASCE 7 *Minimum Design Loads for Buildings and Other Structures*, American Society of Civil Engineers, 1998.

1.1.4 Definitions

Addition: An increase in the building area, aggregate floor area, height, or number of stories of a structure.

Alteration: Any construction or renovation to an existing structure other than an addition.

Component: A part or element of an architectural, electrical, mechanical, or structural system.

Dead load: See Sec. 4.1.3.

Design earthquake ground motion: The earthquake effects that structures are specifically proportioned to resist as defined in Chapter 3.

Essential facility: A facility or structure required for post-earthquake recovery.

Hazardous material: A material that is highly toxic or potentially explosive and in sufficient quantity to pose a significant life-safety threat to the general public if an uncontrolled release were to occur.

Live load: See Sec. 4.1.3.

Occupancy importance factor: A factor assigned to each structure according to its Seismic Use Group as prescribed in Sec. 1.3.

Owner: Any person, agent, firm, or corporation having a legal or equitable interest in the property.

Seismic Design Category: A classification assigned to a structure based on its Seismic Use Group and the severity of the design earthquake ground motion at the site.

Seismic-force-resisting system: That part of the structural system that has been considered in the design to provide the required resistance to the shear prescribed herein.

Seismic forces: The assumed forces prescribed herein, related to the response of the structure to earthquake motions, to be used in the design of the structure and its components.

Seismic Use Group: A classification assigned to the structure based on its use as defined in Sec. 1.2.

Structure: That which is built or constructed.

1.1.5 Notation

F_x The design lateral force applied at level x .

I The occupancy importance factor as defined in Sec. 1.3.

S_I See Sec. 3.1.4.

S_{DI} See Sec. 3.1.4.

S_{DS} See Sec. 3.1.4.

S_S See Sec. 3.1.4.

T See Sec. 4.1.4.

W The seismic weight, including the total dead load and applicable portions of other loads as required by these *Provisions*.

w_x The portion of the seismic weight, W , located or assigned to Level x .

Level x The level under consideration; $x = 1$ designates the first level above the base.

1.2 SEISMIC USE GROUPS

All structures shall be assigned to one of the following Seismic Use Groups:

1.2.1 Seismic Use Group III. Seismic Use Group III structures are those having essential facilities that are required for post-earthquake recovery and those containing substantial quantities of hazardous substances including:

1. Fire, rescue, and police stations
2. Hospitals
3. Designated medical facilities having emergency treatment facilities
4. Designated emergency preparedness centers
5. Designated emergency operation centers
6. Designated emergency shelters
7. Power generating stations or other utilities required as emergency back-up facilities for Seismic Use Group III facilities
8. Emergency vehicle garages and emergency aircraft hangars
9. Designated communication centers
10. Aviation control towers and air traffic control centers
11. Structures containing sufficient quantities of toxic or explosive substances deemed to be hazardous to the public
12. Water treatment facilities required to maintain water pressure for fire suppression.

1.2.2 Seismic Use Group II. Seismic Use Group II structures are those that have a substantial public hazard due to occupancy or use including:

1. Covered structures whose primary occupancy is public assembly with a capacity greater than 300 persons
2. Educational structures through the 12th grade with a capacity greater than 250 persons
3. Day care centers with a capacity greater than 150 persons
4. Medical facilities with greater than 50 resident incapacitated patients not otherwise designated a Seismic Use Group III structure
5. Jails and detention facilities
6. All structures with a capacity greater than 5,000 persons
7. Power generating stations and other public utility facilities not included in Seismic Use Group III and required for continued operation
8. Water treatment facilities required for primary treatment and disinfection for potable water
9. Waste water treatment facilities required for primary treatment.

1.2.3 Seismic Use Group I. Seismic Use Group I structures are those not assigned to Seismic Use Groups III or II.

1.2.4 Multiple use. Structures having multiple uses shall be assigned the classification of the use having the highest Seismic Use Group except that in structures having two or more portions which are structurally separated in accordance with Sec. 4.5.1, each portion shall be separately classified. Where a structurally separated portion of a structure provides access to, egress from, or shares life safety

components with another portion having a higher Seismic Use Group, the lower portion shall be assigned the same rating as the higher.

1.2.5 Seismic Use Group III structure access protection. Where operational access to a Seismic Use Group III structure is required through an adjacent structure, the adjacent structure shall comply with the requirements for Seismic Use Group III structures. Where operational access is less than 10 ft (3 m) from an interior lot line or less than 10 ft (3 m) from another structure, access protection from potential falling debris shall be provided by the owner of the Seismic Use Group III structure.

1.3 OCCUPANCY IMPORTANCE FACTOR

An occupancy importance factor, *I*, shall be assigned to each structure in accordance with Table 1.3-1.

Table 1.3-1 Occupancy Importance Factors

Seismic Use Group	<i>I</i>
I	1.0
II	1.25
III	1.5

1.4 SEISMIC DESIGN CATEGORY

Each structure shall be assigned to a Seismic Design Category in accordance with Sec. 1.4.1. Seismic Design Categories are used in these *Provisions* to determine permissible structural systems, limitations on height and irregularity, those components of the structure that must be designed for seismic resistance, and the types of lateral force analysis that must be performed.

1.4.1 Determination of Seismic Design Category. All structures shall be assigned to a Seismic Design Category based on their Seismic Use Group and the design spectral response acceleration parameters, S_{DS} and S_{DI} , determined in accordance with Chapter 3 of these *Provisions*. Each structure shall be assigned to the more severe Seismic Design Category determined in accordance with Tables 1.4-1 and 1.4-2, irrespective of the fundamental period of vibration of the structure, *T*. If the alternate design procedure of Alternative Simplified Chapter 4 is used, the Seismic Design Category shall be determined from Table 1.4-1 alone, and the value of S_{DS} shall be that determined in Sec Alt. 4.6.1.

Exception: The Seismic Design Category is permitted to be determined from Table 1.4-1 alone when all of the following apply:

1. In each of the two orthogonal directions, the approximate fundamental period of the structure, T_a , determined in accordance with Section 5.2.2.1, is less than $0.8T_s$, where T_s is determined in accordance with Section 3.3.4 and
2. In each of the two orthogonal directions, the fundamental period of the structure used to calculate the story drift is less than T_s and
3. Equation 5.2-2 is used to determine the seismic response coefficient, C_s and
4. The diaphragms are rigid or for diaphragms that are flexible, the distance between vertical elements of the seismic force-resisting system does not exceed 40 feet.

Table 1.4-1 Seismic Design Category Based on S_{DS}

Value of S_{DS}	Seismic Use Group		
	I	II	III
$S_{DS} < 0.167$	A	A	A
$0.167 \leq S_{DS} < 0.33$	B	B	C
$0.33 \leq S_{DS} < 0.50$	C	C	D
$0.50 \leq S_{DS}$	D ^a	D ^a	D ^a

^a See footnote to Table 1.4-2.

Table 1.4-2 Seismic Design Category Based on S_{DI}

Value of S_{DI}	Seismic Use Group		
	I	II	III
$S_{DI} < 0.067$	A	A	A
$0.067 \leq S_{DI} < 0.133$	B	B	C
$0.133 \leq S_{DI} < 0.20$	C	C	D
$0.20 \leq S_{DI}$	D ^a	D ^a	D ^a

^a Seismic Use Group I and II structures located on sites with S_I greater than or equal to 0.75 shall be assigned to Seismic Design Category E and Seismic Use Group III structures located on such sites shall be assigned to Seismic Design Category F.

1.4.2 Site limitation for Seismic Design Categories E and F. A structure assigned to Seismic Design Category E or F shall not be sited where there is the potential for an active fault to cause rupture of the ground surface at the structure.

Exception: Detached one- and two-family dwellings of light-frame construction.

1.5 REQUIREMENTS FOR SEISMIC DESIGN CATEGORY A

Structures assigned to Seismic Design Category A shall satisfy the requirements of this section.

The effects on the structure and its components due to the forces prescribed in this section shall be taken as E and combined with the effects of other loads in accordance with the load combinations of ASCE 7.

1.5.1 Lateral forces. Each structure shall be analyzed for the effects of static lateral forces applied independently in each of two orthogonal directions. In each direction, the static lateral forces at all levels shall be applied simultaneously. The force at each level shall be determined using Eq. 1.5-1 as follows:

$$F_x = 0.01w_x \quad (1.5-1)$$

where:

F_x = the design lateral force applied at Level x ,

w_x = the portion of the seismic weight, W , located or assigned to Level x , and

W = the seismic weight, including the total dead load and applicable portions of other loads listed below:

1. In areas used for storage, a minimum of 25 percent of the floor live load shall be applicable. Floor live load in public garages and open parking structures is not applicable.
2. Where an allowance for partition load is included in the floor load design, the actual partition weight or a minimum weight of 10 psf (500 Pa/m²) of floor area, whichever is greater, shall be applicable.
3. Total operating weight of permanent equipment.
4. In areas where the design flat roof snow load does not exceed 30 pounds per square foot, the effective snow load is permitted to be taken as zero. In areas where the design snow load is greater than 30 pounds per square foot and where siting and load duration conditions warrant and where approved by the authority having jurisdiction, the effective snow load is permitted to be reduced to not less than 20 percent of the design snow load.

1.5.2 Connections. All parts of the structure between separation joints shall be interconnected, and the connections shall be capable of transmitting the seismic forces induced by the parts being connected. Any smaller portion of the structure shall be tied to the remainder of the structure with elements having a strength of not less than 5 percent of the portion's weight.

A positive connection for resisting a horizontal force acting parallel to the member shall be provided for each beam, girder, or truss to its support. The connection shall have a minimum strength of 5 percent of the reaction due to dead load and live load.

1.5.3 Anchorage of concrete or masonry walls. Concrete or masonry walls shall be connected, using reinforcement or anchors, to the roof and all floors and members that provide lateral support for the wall or that are supported by the wall. The connection shall be capable of resisting a seismic lateral force induced by the wall of 100 pounds per lineal foot (1500 N/m). Walls shall be designed to resist bending between connections where the spacing exceeds 4 ft (1.2 m).

1.5.4 Tanks assigned to Seismic Use Group III. Tanks assigned to Seismic Use Group III, according to Table 14.2-2, shall comply with the freeboard requirements of Sec. 14.4.7.5.3. For tanks in Seismic Design Category A it shall be permitted to take S_{DS} equal to 0.166 and S_{DI} equal to 0.066 without determining the site class.

This page intentionally left blank.

Chapter 2

QUALITY ASSURANCE

2.1 GENERAL

2.1.1 Scope. This chapter provides minimum requirements for quality assurance for seismic-force-resisting systems and designated seismic systems. These requirements supplement the testing and inspection requirements contained in the reference standards given elsewhere in these *Provisions*.

2.1.2 References. The following documents shall be used as specified in this chapter.

- ACI 318 *Building Code Requirements for Structural Concrete*, American Concrete Institute, 1999.
- ACI 530 *Building Code Requirements for Masonry Structures* (ACI 530-99/ASCE 5-99/TMS 402-99), American Concrete Institute/American Society of Civil Engineers/The Masonry Society, 1999.
- ACI 530.1 *Specifications for Masonry Structures* (ACI 530.1-99/ASCE 6-99/TMS 602-99), American Concrete Institute/American Society of Civil Engineers/The Masonry Society, 1999.
- AISC LRFD *Load and Resistance Factor Design Specification for Structural Steel Buildings*, American Institute of Steel Construction, 1993.
- AISC Seismic *Seismic Provisions for Structural Steel Buildings*, Part I, American Institute of Steel Construction, 1997, including Supplement No. 2 (2000).
- ASTM A 435 *Standard Specification for Straight Beam Ultrasound Examination of Steel Plates* (A 435-90), American Society for Testing and Materials, 1996.
- ASTM A 615 *Standard Specification for Deformed and Plain Billet-steel Bars for Concrete Reinforcement* (A 615/A 615M-96a), American Society for Testing and Materials, 1996.
- ASTM A 898 *Standard Specification for Straight Beam Ultrasound Examination for Rolled Steel Structural Shapes* (A 898/A 898M-91), American Society for Testing and Materials, 1996.

2.1.3 Definitions

Approval: The written acceptance by the authority having jurisdiction of documentation that establishes the qualification of a material, system, component, procedure, or person to fulfill the requirements of these *Provisions* for the intended use.

Boundary elements:

In wood construction, members at the boundaries of diaphragms and shear walls to which sheathing transfers forces. Such elements include chords and drag struts at diaphragm and shear wall perimeters, interior openings, discontinuities, and re-entrant corners.

In concrete and masonry construction, portions along wall and diaphragm edges strengthened by longitudinal and transverse reinforcement and/or structural steel members.

Component: See Sec. 1.1.4.

Construction documents: The written, graphic, electronic, and pictorial documents describing the design, locations, and physical characteristics of the project required to verify compliance with these *Provisions*.

Continuous special inspection: A full-time observation of the work by an approved special inspector who is present in the area where work is being performed.

Designated seismic system: Those architectural, mechanical, and electrical systems and their components that require design in accordance with Sec. 6.1 and that have a component importance factor, I_p , greater than 1.

Design strength: See Sec. 4.1.3.

Diaphragm: See Sec. 4.1.3.

Drag strut: See Sec. 4.1.3.

Glazed curtain wall: See Sec. 6.1.3.

Glazed storefront: See Sec. 6.1.3.

Intermediate moment frame: See Sec. 4.1.3.

Isolation system: See Sec. 13.1.2.

Isolator unit: See Sec. 13.1.2.

Moment frame: See Sec. 4.1.3.

Partition: See Sec. 5.1.2.

Periodic special inspection: The part-time or intermittent observation of the work by an approved special inspector who is present in the area where work has been or is being performed.

Quality Assurance: The systematic program of special inspections, structural observations, testing and reporting which provides the independent documentation that the project is constructed in accordance with the construction documents.

Quality Assurance Plan: A detailed, written procedural document, prepared by one or more registered design professionals, that establishes the systems and components subject to special inspection and testing.

Quality Control: The operational procedures provided by contractors to ensure compliance with the construction documents and regulatory requirements.

Registered design professional: An architect or engineer, registered or licensed to practice professional architecture or engineering, as defined by statutory requirements of the professional registrations laws of the state in which the project is to be constructed.

Seismic Design Category: See Sec. 1.1.4.

Seismic-force-resisting system: See Sec. 1.1.4.

Seismic Use Group: See Sec. 1.1.4.

Shear panel: See Sec. 4.1.3.

Shear wall: See Sec. 4.1.3.

Special inspection: The observation of the work by the special inspector to determine compliance with the approved construction documents and these *Provisions*.

Special inspector: A person or persons approved by the authority having jurisdiction as being qualified to perform special inspection required by the approved quality assurance plan. The quality assurance personnel of a fabricator are permitted to be approved by the authority having jurisdiction as a special inspector.

Special moment frame: See Sec. 4.1.3.

Story: See Sec. 4.1.3.

Structural observations: The visual observations performed by the registered design professional in responsible charge (or another registered design professional) to determine that the seismic-force-resisting system is constructed in general conformance with the construction documents.

Structure: See Sec. 1.1.4.

Testing agency: A company or corporation that provides testing and/or inspection services. The person in responsible charge of the special inspector and the testing services shall be a registered design professional.

Tie-down: See Sec. 12.1.3.

Veneer: Facing or ornamentation of brick, concrete, stone, tile, or similar materials attached to a backing.

2.1.4 Notation

S_{DS} See Sec. 3.1.4.

2.2 GENERAL REQUIREMENTS

As required in this section, a quality assurance plan shall be submitted to the authority having jurisdiction. A quality assurance plan, special inspection, and testing as set forth in this chapter shall be provided for the following:

1. The seismic-force-resisting systems in structures assigned to Seismic Design Category C, D, E, or F.
2. Designated seismic systems in structures assigned to Seismic Design Category D, E, or F.

Exception: Structures that comply with item a and item b and with either item c or item d of the following criteria are exempt from the preparation of a quality assurance plan but are not exempt from special inspection or testing requirements:

- a. The structure is assigned to Seismic Use Group I.
- b. The structure does not have any of the following irregularities as defined in Tables 4.3-2 and 4.3-3:
 - i. Torsional irregularity,
 - ii. Extreme torsional irregularity,
 - iii. Nonparallel systems,
 - iv. Stiffness irregularity—soft story,
 - v. Stiffness irregularity—extreme soft story,
 - vi. Discontinuity in capacity—weak story.
- c. The structure is constructed of light wood framing or light gauge cold-formed steel framing, S_{DS} does not exceed 0.5, and the height of the structure does not exceed 35 ft above grade.
- d. The structure is constructed using a reinforced masonry structural system or reinforced concrete structural system, S_{DS} does not exceed 0.5, and the height of the structure does not exceed 25 ft above grade.

2.2.1 Details of quality assurance plan. The registered design professional in responsible charge of the design of a seismic-force-resisting system or a designated seismic system shall be responsible for the portion of the quality assurance plan applicable to that system. The quality assurance plan shall include:

1. A listing of the seismic-force-resisting systems and designated seismic systems that are subject to quality assurance in accordance with this chapter.
2. The required special inspection and testing.
3. The type and frequency of testing.

4. The type and frequency of special inspection.
5. The frequency and distribution of testing and special inspection reports.
6. The structural observations to be performed.
7. The frequency and distribution of structural observation reports.

2.2.2 Contractor responsibility. Each contractor responsible for the construction of a seismic-force-resisting system, designated seismic system, or component listed in the quality assurance plan shall submit a written contractor's statement of responsibility to the authority having jurisdiction and to the owner prior to the commencement of work on the system or component. The contractor's statement of responsibility shall contain the following:

1. Acknowledgment of awareness of the requirements contained in the quality assurance plan;
2. Acknowledgment that control will be exercised to obtain conformance with the construction documents approved by the authority having jurisdiction;
3. Procedures for exercising control within the contractor's organization, the method and frequency of reporting, and the distribution of the reports; and
4. Identification and qualifications of the person(s) exercising such control and their position(s) in the organization.

2.3 SPECIAL INSPECTION

The owner shall employ a special inspector who, at a minimum, shall perform the following inspections:

2.3.1 Piers, piles, and caissons. Continuous special inspection during driving of piles and placement of concrete in piers, piles, and caissons. Periodic special inspection during construction of drilled piles, piers, and caissons including the placement of reinforcing steel.

2.3.2 Reinforcing steel

2.3.2.1. Periodic special inspection during and upon completion of the placement of reinforcing steel in intermediate moment frames, in special moment frames, and in shear walls.

2.3.2.2. Continuous special inspection during the welding of reinforcing steel resisting flexural and axial forces in intermediate moment frames and special moment frames, in boundary elements of concrete shear walls, and during welding of shear reinforcement.

2.3.3 Structural concrete. Periodic special inspection during and on completion of the placement of concrete in intermediate moment frames, in special moment frames, and in boundary elements of shear walls.

2.3.4 Prestressed concrete. Periodic special inspection during the placement and after completion of placement of prestressing steel and continuous special inspection during all stressing and grouting operations and during the placement of concrete.

2.3.5 Structural masonry

2.3.5.1. Periodic special inspection during the preparation of mortar, the laying of masonry units, and placement of reinforcement, and prior to placement of grout.

2.3.5.2. Continuous special inspection during the welding of reinforcement, grouting, consolidation, reconsolidation, and placement of bent-bar anchors as required by Sec. 11.6.4.1.

2.3.6 Structural steel

2.3.6.1. Continuous special inspection for all structural welding.

Exception: Periodic special inspection is permitted for single-pass fillet or resistance welds and welds loaded to less than 50 percent of their design strength provided the qualifications of the

welder and the welding electrodes are inspected at the beginning of the work and all welds are inspected for compliance with the approved construction documents at the completion of welding.

2.3.6.2. Periodic special inspection in accordance with AISC LRFD for installation and tightening of fully tensioned high-strength bolts in slip-critical connections and in connections subject to direct tension. Bolts in connections identified as not being slip-critical or subject to direct tension need not be inspected for bolt tension other than to ensure that the plies of the connected elements have been brought into snug contact.

2.3.7 Structural wood

2.3.7.1. Continuous special inspection during all field gluing operations of elements of the seismic-force-resisting system.

2.3.7.2. Periodic special inspection for nailing, bolting, anchoring, and other fastening of components within the seismic-force-resisting system including drag struts, braces, and tie-downs.

2.3.7.3. Periodic special inspection for wood shear walls, shear panels, and diaphragms that are included in the seismic-force-resisting system and for which the *Provisions* require the spacing of nails, screws, or fasteners for wood sheathing to be 4 in. or less on center.

2.3.8 Cold-formed steel framing

2.3.8.1. Periodic special inspections during all welding operations of elements of the seismic-force-resisting system.

2.3.8.2. Periodic special inspections for screw attachment, bolting, anchoring, and other fastening of components within the seismic-force-resisting system, including struts, braces, and tie-downs.

2.3.9 Architectural components. Special inspection for architectural components shall be as follows:

1. Periodic special inspection during the erection and fastening of exterior cladding, interior and exterior nonbearing walls, and interior and exterior veneer in Seismic Design Category D, E, or F.

Exceptions:

- a. Architectural components less than 30 ft (9 m) above grade or walking surface
 - b. Cladding and veneer weighing 5 lb/ft² (24.5 N/m²) or less
 - c. Interior nonbearing walls weighing 15 lb/ft² (73.5 N/m²) or less.
2. Periodic special inspection during erection of glass 30 ft (9 m) or more above an adjacent grade or walking surface in glazed curtain walls, glazed storefronts, and interior glazed partitions in Seismic Design Category D, E, or F.
 3. Periodic special inspection during the anchorage of access floors, suspended ceiling grids, and storage racks 8 ft (2.4 m) or more in height in Seismic Design Category D, E, or F.

2.3.10 Mechanical and electrical components. Special inspection for mechanical and electrical components shall be as follows:

1. Periodic special inspection during the anchorage of electrical equipment for emergency or standby power systems in Seismic Design Category C, D, E, or F;
2. Periodic special inspection during the installation of anchorage of all other electrical equipment in Seismic Design Category E or F;
3. Periodic special inspection during installation for flammable, combustible, or highly toxic piping systems and their associated mechanical units in Seismic Design Category C, D, E, or F;

4. Periodic special inspection during the installation of HVAC ductwork that will contain hazardous materials in Seismic Design Category C, D, E, or F; and
5. Periodic special inspection during the installation of vibration isolation systems where the construction documents call for a nominal clearance (air gap) between the equipment support frame and restraint less than or equal to 0.25 inches.

2.3.11 Seismic isolation system. Periodic special inspection during the fabrication and installation of isolator units and energy dissipation devices if used as part of the seismic isolation system.

2.4 TESTING

The special inspector shall be responsible for verifying that the testing requirements are performed by an approved testing agency for compliance with the following:

2.4.1 Reinforcing and prestressing steel. Special testing of reinforcing and prestressing steel shall be as follows:

2.4.1.1. Examine certified mill test reports for each shipment of reinforcing steel used to resist flexural and axial forces in reinforced concrete intermediate frames, special moment frames, and boundary elements of reinforced concrete shear walls or reinforced masonry shear walls and determine conformance with the construction documents.

2.4.1.2. Where ASTM A 615 reinforcing steel is used to resist earthquake-induced flexural and axial forces in special moment frames and in wall boundary elements of shear walls in structures assigned to Seismic Design Category D, E, or F, verify that the requirements of Sec. 21.2.5 of ACI 318 have been satisfied.

2.4.1.3. Where ASTM A 615 reinforcing steel is to be welded, verify that chemical tests have been performed to determine weldability in accordance with Sec. 3.5.2 of ACI 318.

2.4.2 Structural concrete. Samples of structural concrete shall be obtained at the project site and tested in accordance with requirements of ACI 318.

2.4.3 Structural masonry. Quality assurance testing of structural masonry shall be in accordance with the requirements of ACI 530 and ACI 530.1.

2.4.4 Structural steel. The testing needed to establish that the construction is in conformance with these *Provisions* shall be included in a quality assurance plan. The minimum testing contained in the quality assurance plan shall be as required in AISC Seismic and the following requirements:

2.4.4.1 Base metal testing. Base metal thicker than 1.5 in. (38 mm), where subject to through-thickness weld shrinkage strains, shall be ultrasonically tested for discontinuities behind and adjacent to such welds after joint completion. Any material discontinuities shall be accepted or rejected on the basis of ASTM A 435 or ASTM A 898 (Level 1 Criteria) and criteria as established by the registered design professional in responsible charge and the construction documents.

2.4.5 Mechanical and electrical equipment. As required to ensure compliance with the seismic design requirements herein, the registered design professional in responsible charge shall clearly state the applicable requirements on the construction documents. Each manufacturer of designated seismic system components shall test or analyze the component and its mounting system or anchorage as required and shall submit evidence of compliance for review and acceptance by the registered design professional in responsible charge of the designated seismic system and for approval by the authority having jurisdiction. The evidence of compliance shall be by actual test on a shake table, by three-dimensional shock tests, by an analytical method using dynamic characteristics and forces, by the use of experience data (i.e., historical data demonstrating acceptable seismic performance), or by more rigorous analysis providing for equivalent safety. The special inspector shall examine the designated seismic system and shall determine whether the anchorages and label conform with the evidence of compliance.

2.4.6 Seismically isolated structures. Isolation system components shall be tested in accordance with Sec 13.6.

2.5 STRUCTURAL OBSERVATIONS

Structural observations shall be provided for those structures assigned to Seismic Design Category D, E, or F where one or more of the following conditions exist:

1. The structure is included in Seismic Use Group II or Seismic Use Group III or
2. The height of the structure is greater than 75 ft above the base or
3. The structure is in Seismic Design Category E or F and Seismic Use Group I and is greater than two stories in height.

Observed deficiencies shall be reported in writing to the owner and the authority having jurisdiction.

2.6 REPORTING AND COMPLIANCE PROCEDURES

Each special inspector shall furnish copies of inspection reports, noting any work not in compliance with the approved construction documents and corrections made to previously reported work to the authority having jurisdiction, registered design professional in responsible charge, the owner, the registered design professional preparing the quality assurance plan, and the contractor. All deficiencies shall be brought to the immediate attention of the contractor for correction.

At completion of construction, each special inspector shall submit a report certifying that all inspected work was completed substantially in compliance with the approved construction documents. Work not in compliance with the approved construction documents shall be described in the report.

At completion of construction, the contractor shall submit a final report to the authority having jurisdiction certifying that all construction work incorporated into the seismic-force-resisting system and other designated seismic systems was constructed substantially in compliance with the approved construction documents.

This page is intentionally left blank.

Chapter 3

GROUND MOTION

3.1 GENERAL

3.1.1 Scope. All structures shall be designed for the earthquake ground motions prescribed in this chapter. If the alternate design procedure of Alternative Simplified Chapter 4 is used, the values of F_a , S_{MS} , and S_{DS} shall be as determined in that Alternate Chapter, and values for F_v , S_{MI} , and S_{DI} need not be determined.

3.1.2 References. The following documents shall be used as specified in this chapter.

ASTM D 1586 *Standard Test Method for Penetration Test and Split-barrel Sampling of Soils* (D 1586-99), American Society for Testing and Materials, 2003.

ASTM D 2166 *Standard Test Method for Unconfined Compressive Strength of Cohesive Soil* (D 2166-00), American Society for Testing and Materials, 2003.

ASTM D 2216 *Standard Test Method for Laboratory Determination of Water (Moisture) Content of Soil and Rock by Mass* (D 2216-98), American Society for Testing and Materials, 2003.

ASTM D 2850 *Standard Test Method for Unconsolidated-Undrained Triaxial Compression Test on Cohesive Soils in* (D 2850-03), American Society for Testing and Materials, 2003.

ASTM D 4318 *Standard Test Methods for Liquid Limit, Plastic Limit, and Plasticity Index of Soils* (D 4318-00), American Society for Testing and Materials, 2003.

3.1.3 Definitions

Active fault: A fault for which there is an average historic slip rate of 1 mm per year or more and geographic evidence of seismic activity within Holocene times (past 11,000 years).

Characteristic earthquake: An earthquake assessed for an active fault having a magnitude equal to the best-estimate of the maximum magnitude capable of occurring on the fault, but not less than the largest magnitude that has occurred historically on the fault.

Design earthquake ground motion: See Sec. 1.1.4.

Maximum considered earthquake ground motion: The most severe earthquake effects considered by these *Provisions* as defined in this chapter.

Seismic Design Category: See Sec. 1.1.4.

Site Class: A classification assigned to a site based on the types of soils present and their properties as defined in Sec. 3.5.1.

Site coefficients: The values of F_a and F_v indicated in Tables 3.3-1 and 3.3-2, respectively.

Structure: See Sec. 1.1.4.

3.1.4 Notation

d_c The total thickness of cohesive soil layers in the top 100 ft (30 m); see Sec. 3.5.1.

d_i The thickness of any soil or rock layer i (between 0 and 100 ft [30 m]); see Sec. 3.5.1.

d_s The total thickness of cohesionless soil layers in the top 100 ft (30 m); see Sec. 3.5.1.

F_a Short-period site coefficient (at 0.2 sec period); see Sec. 3.3.2.

F_v	Long-period site coefficient (at 1.0 second period); see Sec. 3.3.2.
H	Thickness of soil.
N	Standard penetration resistance, ASTM D1586-99.
N_i	Standard penetration resistance of any soil or rock layer i (between 0 and 100 ft (30m)); see Sec.3.5.1.
\bar{N}	Average standard penetration resistance for the top 100 ft (30 m); see Sec. 3.5.1.
\bar{N}_{ch}	Average standard penetration resistance of cohesionless soil layers for the top 100 ft (30 m); see Sec. 3.5.1.
PI	Plasticity index, ASTM D4318.
S_I	The mapped, maximum considered earthquake, 5-percent-damped, spectral response acceleration parameter at a period of one second as determined in Sec. 3.3.1.
S_a	The design spectral response acceleration at any period as defined in this chapter.
S_{aM}	The maximum considered earthquake spectral response acceleration at any period as defined in this chapter.
S_{DI}	The design, 5-percent-damped, spectral response acceleration parameter at a period of one second as defined in Sec. 3.3.3.
S_{DS}	The design, 5-percent-damped, spectral response acceleration parameter at short periods as defined in Sec. 3.3.3.
S_{MI}	The maximum considered earthquake, 5-percent-damped, spectral response acceleration parameter at a period of one second adjusted for site class effects as defined in Sec. 3.3.2.
S_{MS}	The maximum considered earthquake, 5-percent-damped, spectral response acceleration parameter at short periods adjusted for site class effects as defined in Sec. 3.3.2.
S_S	The mapped, maximum considered earthquake, 5-percent-damped, spectral response acceleration parameter at short periods as determined in Sec. 3.3.1.
s_u	Undrained shear strength, ASTM D2166 or ASTM D2850.
s_{ui}	Undrained shear strength of any cohesive soil layer i (between 0 and 100 ft (30 m)); see Sec. 3.5.1.
\bar{s}_u	Average undrained shear strength in top 100 ft. (30 m); see Sec. 3.5.1.
T	See Sec. 4.1.4.
T_0	$0.2S_{DI}/S_{DS}$
T_L	Long-period transition period as defined in Sec. 3.3.4.
T_S	S_{DI}/S_{DS} .
v_s	The shear wave velocity at small shear strains (equal to 10-3 percent strain or less).
v_{si}	The shear wave velocity of any soil or rock layer i (between 0 and 100 ft (30m)); see Sec. 3.5.1.
\bar{v}_s	The average shear wave velocity at small shear strains in the top 100 ft (30 m); see Sec. 3.5.1.
w	Moisture content (in percent), ASTM D2216.

3.2 GENERAL REQUIREMENTS

As used in these *Provisions*, spectral acceleration parameters are coefficients corresponding to spectral accelerations in terms of g , the acceleration due to gravity.

3.2.1 Site Class. For all structures, the site shall be classified in accordance with Sec. 3.5.

3.2.2 Procedure selection

Ground motions, represented by response spectra and parameters associated with those spectra, shall be determined in accordance with the general procedure of Sec. 3.3 or the site-specific procedure of Sec. 3.4. Ground motions for structures on class F sites and for seismically isolated structures on sites with S_I greater than 0.6 shall be determined using the site-specific procedure of Sec. 3.4.

3.3 GENERAL PROCEDURE

3.3.1 Mapped acceleration parameters. The parameters S_S and S_I shall be determined from the respective 0.2 sec and 1.0 sec spectral response accelerations shown on Figures 3.3-1 through Figures 3.3-14.

3.3.2 Site coefficients and adjusted acceleration parameters. The maximum considered earthquake (MCE) spectral response acceleration parameters S_{MS} and S_{MI} , adjusted for site class effects, shall be determined using Eq. 3.3-1 and 3.3-2, respectively:

$$S_{MS} = F_a S_S \quad (3.3-1)$$

and

$$S_{MI} = F_v S_I \quad (3.3-2)$$

where F_a and F_v are defined in Tables 3.3-1 and 3.3-2, respectively.

Table 3.3-1 Values of Site Coefficient F_a

Site Class	Mapped MCE Spectral Response Acceleration Parameter at 0.2 Second Period ^a				
	$S_S \leq 0.25$	$S_S = 0.50$	$S_S = 0.75$	$S_S = 1.00$	$S_S \geq 1.25$
A	0.8	0.8	0.8	0.8	0.8
B	1.0	1.0	1.0	1.0	1.0
C	1.2	1.2	1.1	1.0	1.0
D	1.6	1.4	1.2	1.1	1.0
E	2.5	1.7	1.2	0.9	0.9
F	— ^b	— ^b	— ^b	— ^b	— ^b

^a Use straight line interpolation for intermediate values of S_S .

^b Site-specific geotechnical investigation and dynamic site response analyses shall be performed.

FIGURE 3.3-1 MAXIMUM CONSIDERED EARTHQUAKE GROUND MOTION FOR THE CONTERMINOUS UNITED STATES OF 0.2 SEC SPECTRAL RESPONSE ACCELERATION (5% OF CRITICAL DAMPING), SITE CLASS B

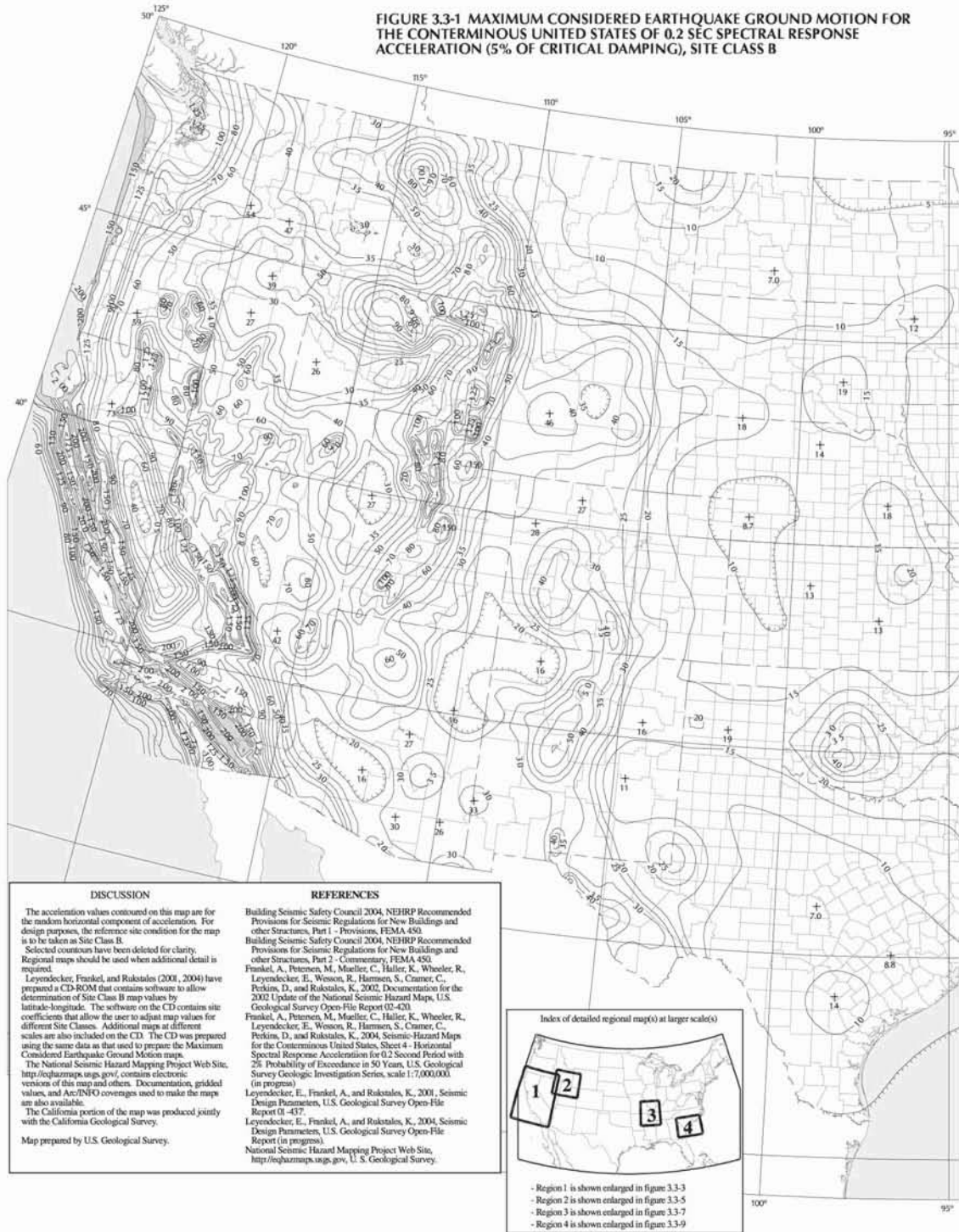

DISCUSSION

The acceleration values contoured on this map are for the random horizontal component of acceleration. For design purposes, the reference site condition for the map is to be taken as Site Class B.
 Selected contours have been deleted for clarity. Regional maps should be used when additional detail is required.
 Leyendecker, Frankel, and Rukstales (2001, 2004) have prepared a CD-ROM that contains software to allow determination of Site Class B map values by latitude-longitude. The software on the CD contains site coefficients that allow the user to adjust map values for different Site Classes. Additional maps at different scales are also included on the CD. The CD was prepared using the same data as that used to prepare the Maximum Considered Earthquake Ground Motion maps.
 The National Seismic Hazard Mapping Project Web Site, <http://eqhazmaps.usgs.gov>, contains electronic versions of this map and others. Documentation, gridded values, and Arc/INFO coverages used to make the map are also available.
 The California portion of the map was produced jointly with the California Geological Survey.
 Map prepared by U.S. Geological Survey.

REFERENCES

Building Seismic Safety Council 2004, NEHRP Recommended Provisions for Seismic Regulations for New Buildings and other Structures, Part 1 - Provisions, FEMA 450.
 Building Seismic Safety Council 2004, NEHRP Recommended Provisions for Seismic Regulations for New Buildings and other Structures, Part 2 - Commentary, FEMA 450.
 Frankel, A., Petersen, M., Mueller, C., Haller, K., Wheeler, R., Leyendecker, E., Wesson, R., Harmsen, S., Cramer, C., Perkins, D., and Rukstales, K., 2002, Documentation for the 2002 Update of the National Seismic Hazard Maps, U.S. Geological Survey Open-File Report 02-420.
 Frankel, A., Petersen, M., Mueller, C., Haller, K., Wheeler, R., Leyendecker, E., Wesson, R., Harmsen, S., Cramer, C., Perkins, D., and Rukstales, K., 2004, Seismic Hazard Maps for the Conterminous United States, Sheet 4 - Horizontal Spectral Response Acceleration for 0.2 Second Period with 2% Probability of Exceedence in 50 Years, U.S. Geological Survey Geologic Investigation Series, scale 1:7,000,000. (in progress)
 Leyendecker, E., Frankel, A., and Rukstales, K., 2001, Seismic Design Parameters, U.S. Geological Survey Open-File Report 01-437.
 Leyendecker, E., Frankel, A., and Rukstales, K., 2004, Seismic Design Parameters, U.S. Geological Survey Open-File Report (in progress).
 National Seismic Hazard Mapping Project Web Site, <http://eqhazmaps.usgs.gov>, U. S. Geological Survey.

Index of detailed regional map(s) at larger scale(s)

- Region 1 is shown enlarged in figure 3.3-3
- Region 2 is shown enlarged in figure 3.3-5
- Region 3 is shown enlarged in figure 3.3-7
- Region 4 is shown enlarged in figure 3.3-9

FIGURE 3.3-1 (continued) MAXIMUM CONSIDERED EARTHQUAKE GROUND MOTION FOR THE CONTERMINOUS UNITED STATES OF 0.2 SEC SPECTRAL RESPONSE ACCELERATION (5% OF CRITICAL DAMPING), SITE CLASS B



FIGURE 3.3-2 MAXIMUM CONSIDERED EARTHQUAKE GROUND MOTION FOR THE CONTINUOUS UNITED STATES OF 1.0 SEC SPECTRAL RESPONSE ACCELERATION (5% OF CRITICAL DAMPING), SITE CLASS B

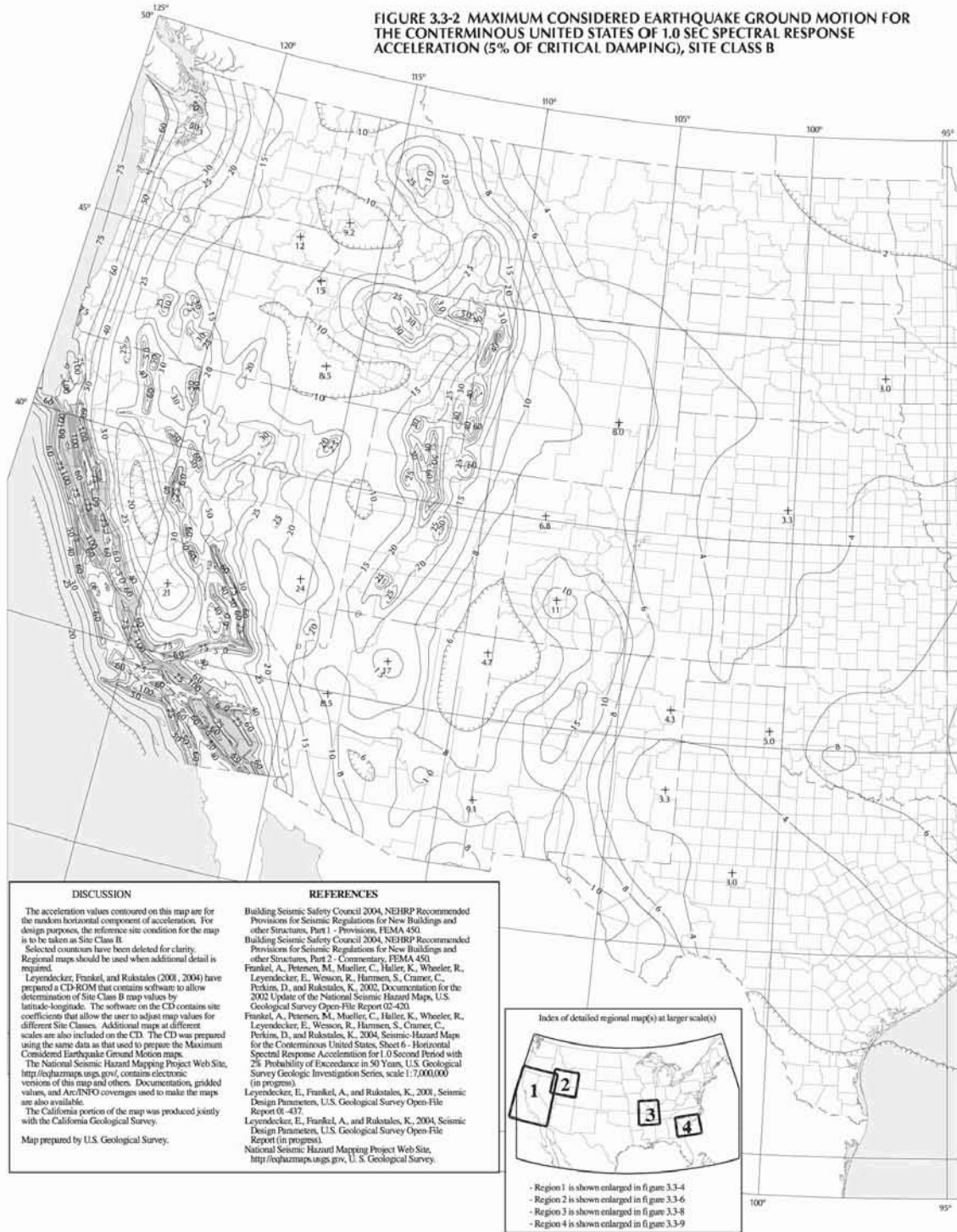

FIGURE 3.3-2 (continued) MAXIMUM CONSIDERED EARTHQUAKE GROUND MOTION FOR THE CONTERMINOUS UNITED STATES OF 1.0 SEC SPECTRAL RESPONSE ACCELERATION (5% OF CRITICAL DAMPING), SITE CLASS B

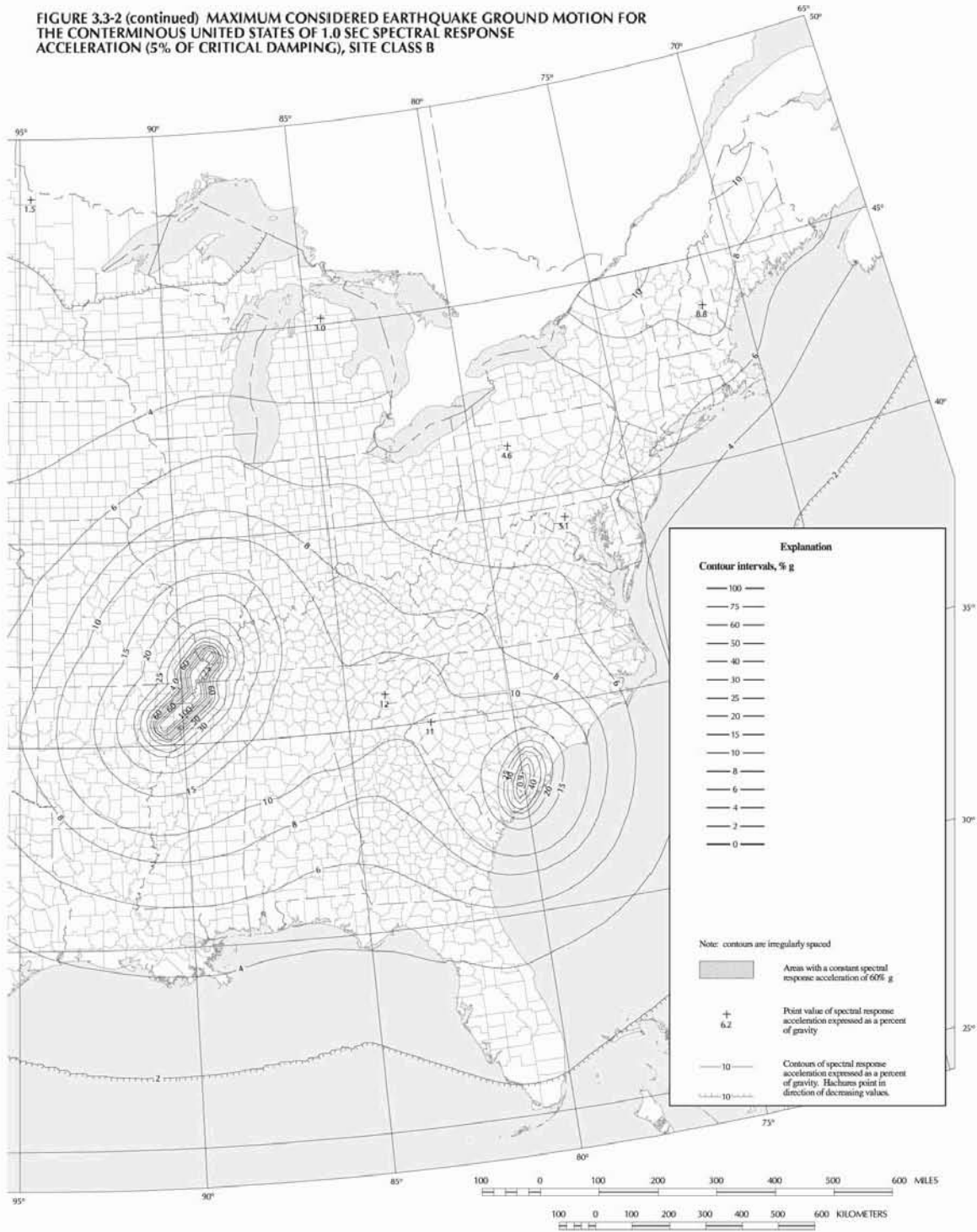

FIGURE 3.3-3. MAXIMUM CONSIDERED EARTHQUAKE GROUND MOTION FOR REGION 1 OF 0.2 SEC SPECTRAL RESPONSE ACCELERATION (5% OF CRITICAL DAMPING), SITE CLASS B



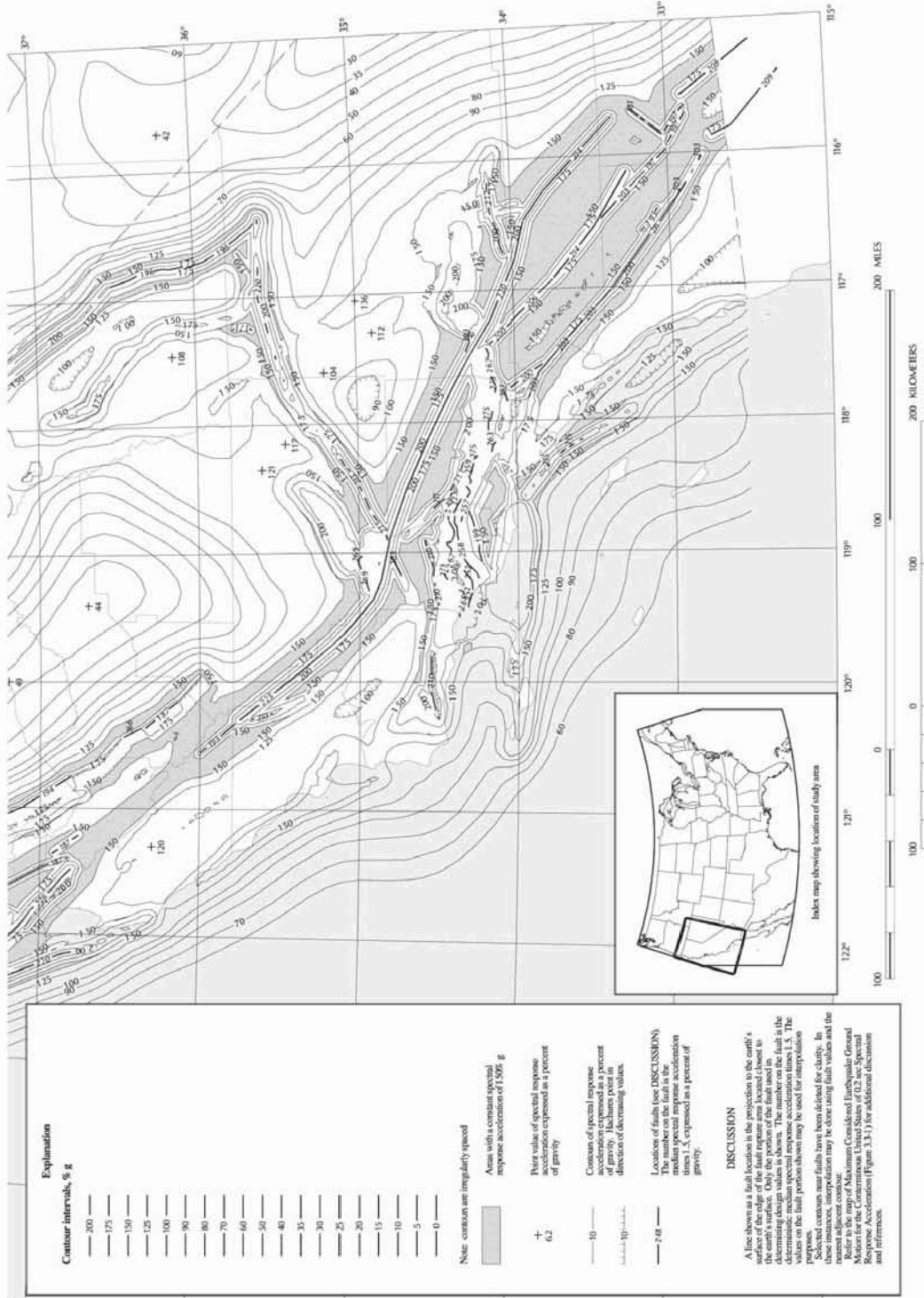
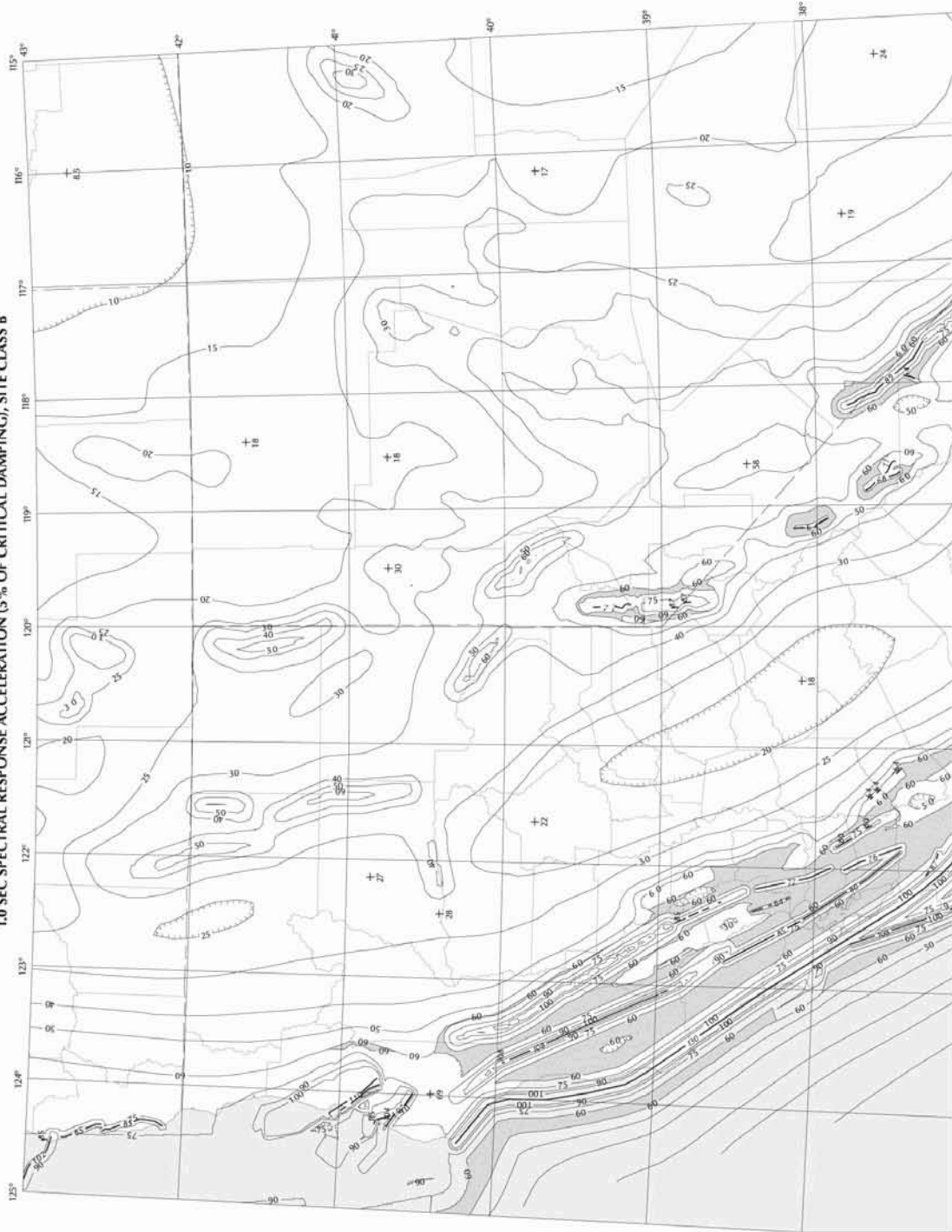

FIGURE 3.3-3 (continued) MAXIMUM CONSIDERED EARTHQUAKE GROUND MOTION FOR REGION 1 OF 0.2 SEC SPECTRAL RESPONSE ACCELERATION (5% OF CRITICAL DAMPING), SITE CLASS B

FIGURE 3.3-4. MAXIMUM CONSIDERED EARTHQUAKE GROUND MOTION FOR REGION 1 OF 1.0 SEC SPECTRAL RESPONSE ACCELERATION (5% OF CRITICAL DAMPING), SITE CLASS B



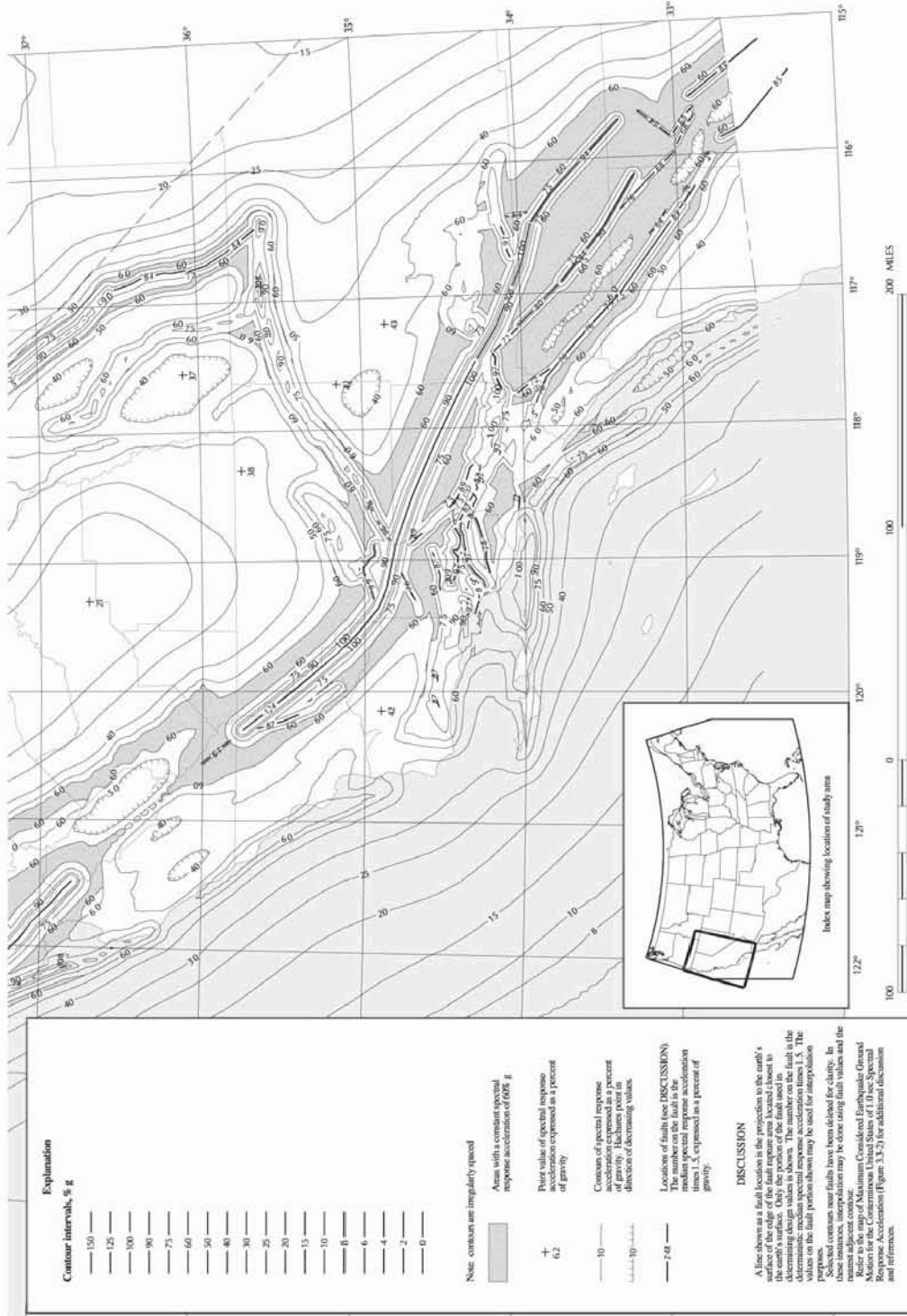

FIGURE 3.3-4 (continued) MAXIMUM CONSIDERED EARTHQUAKE GROUND MOTION FOR REGION 1 OF 1.0 SEC SPECTRAL RESPONSE ACCELERATION (5% OF CRITICAL DAMPING), SITE CLASS B

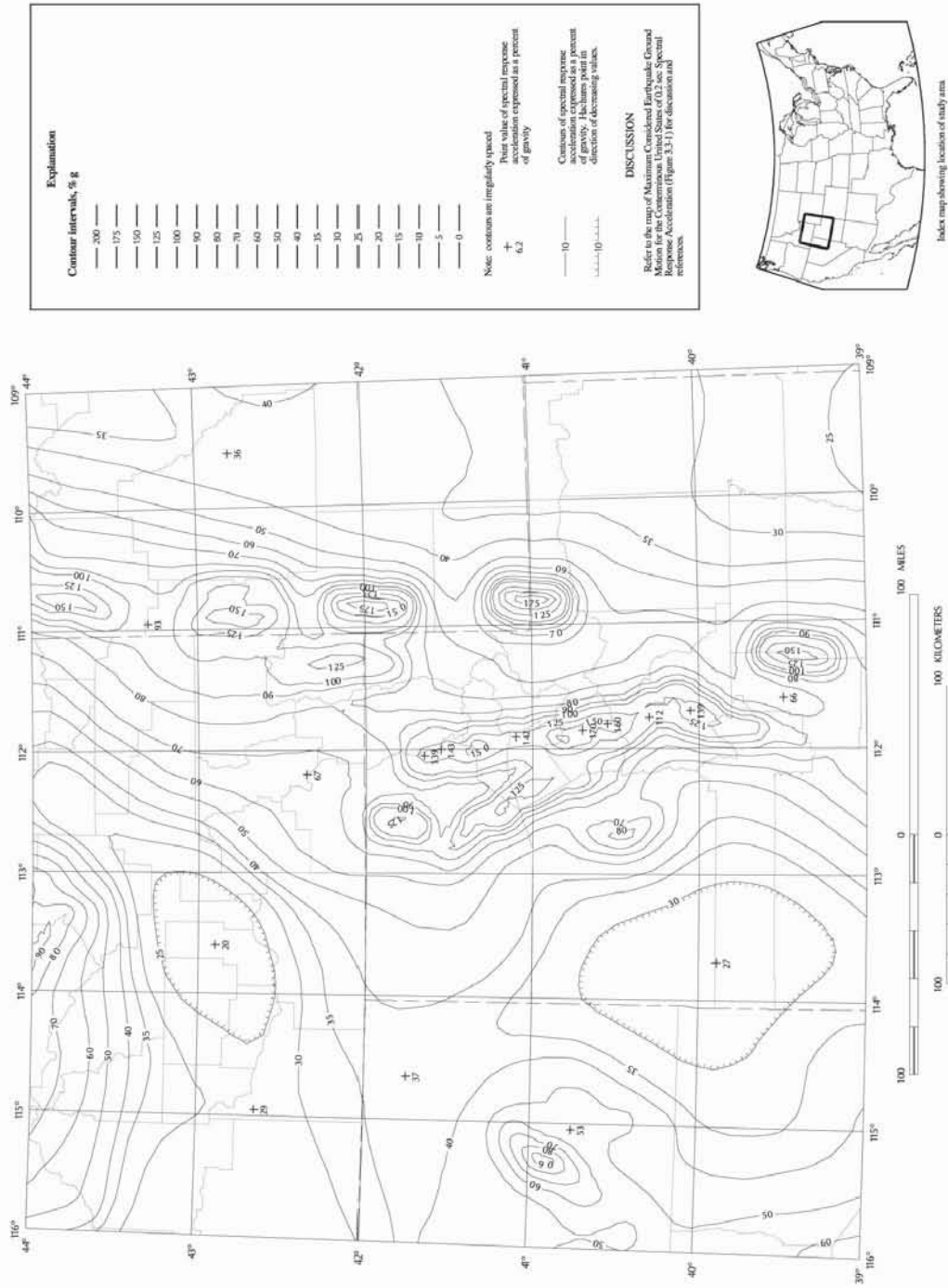

FIGURE 3.3-5 MAXIMUM CONSIDERED EARTHQUAKE GROUND MOTION FOR REGION 2 OF 0.2 SEC SPECTRAL RESPONSE ACCELERATION (5% OF CRITICAL DAMPING), SITE CLASS B

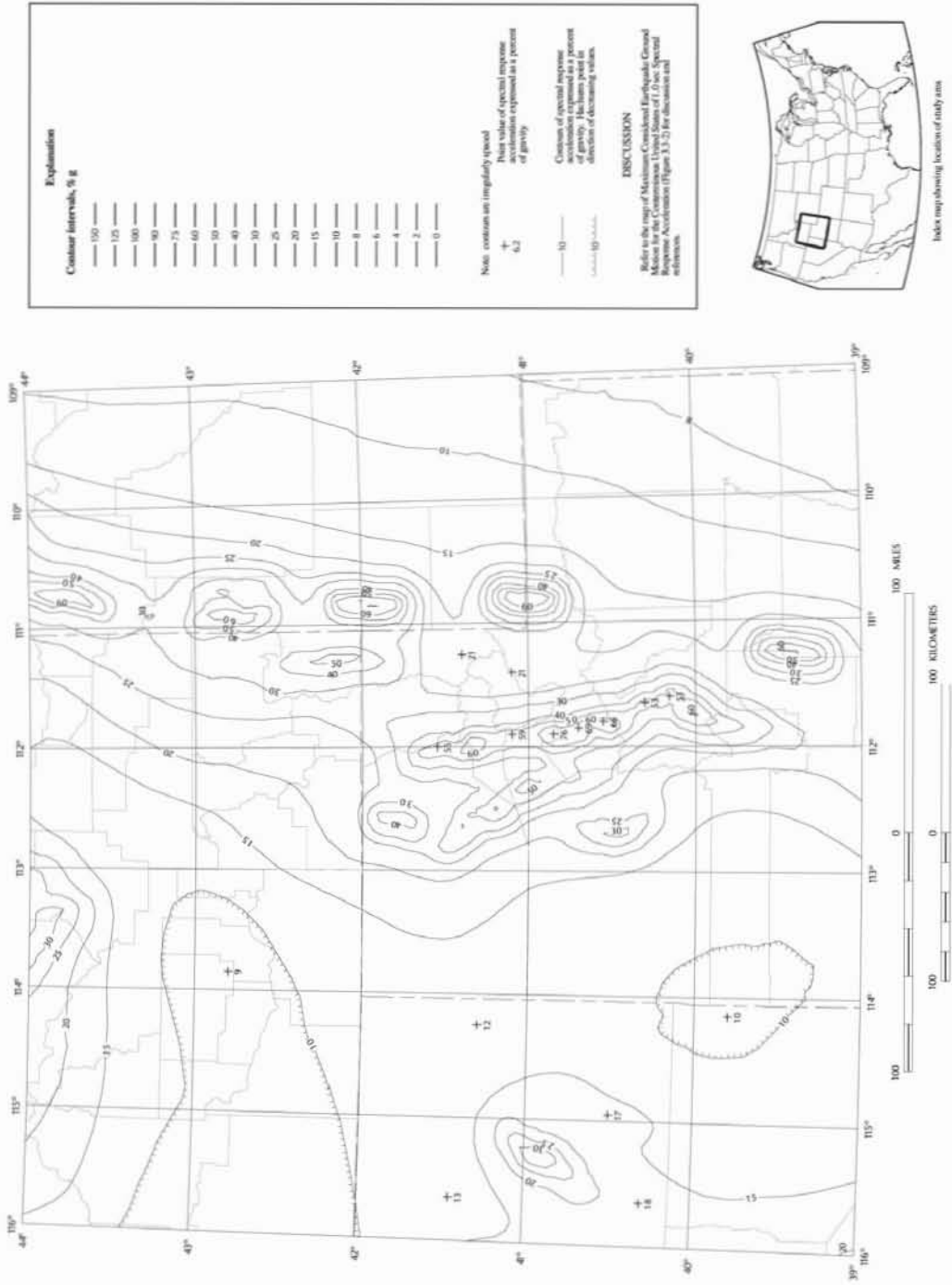

FIGURE 3.3-6 MAXIMUM CONSIDERED EARTHQUAKE GROUND MOTION FOR REGION 2 OF 1.0 SEC SPECTRAL RESPONSE ACCELERATION (5% OF CRITICAL DAMPING), SITE CLASS B

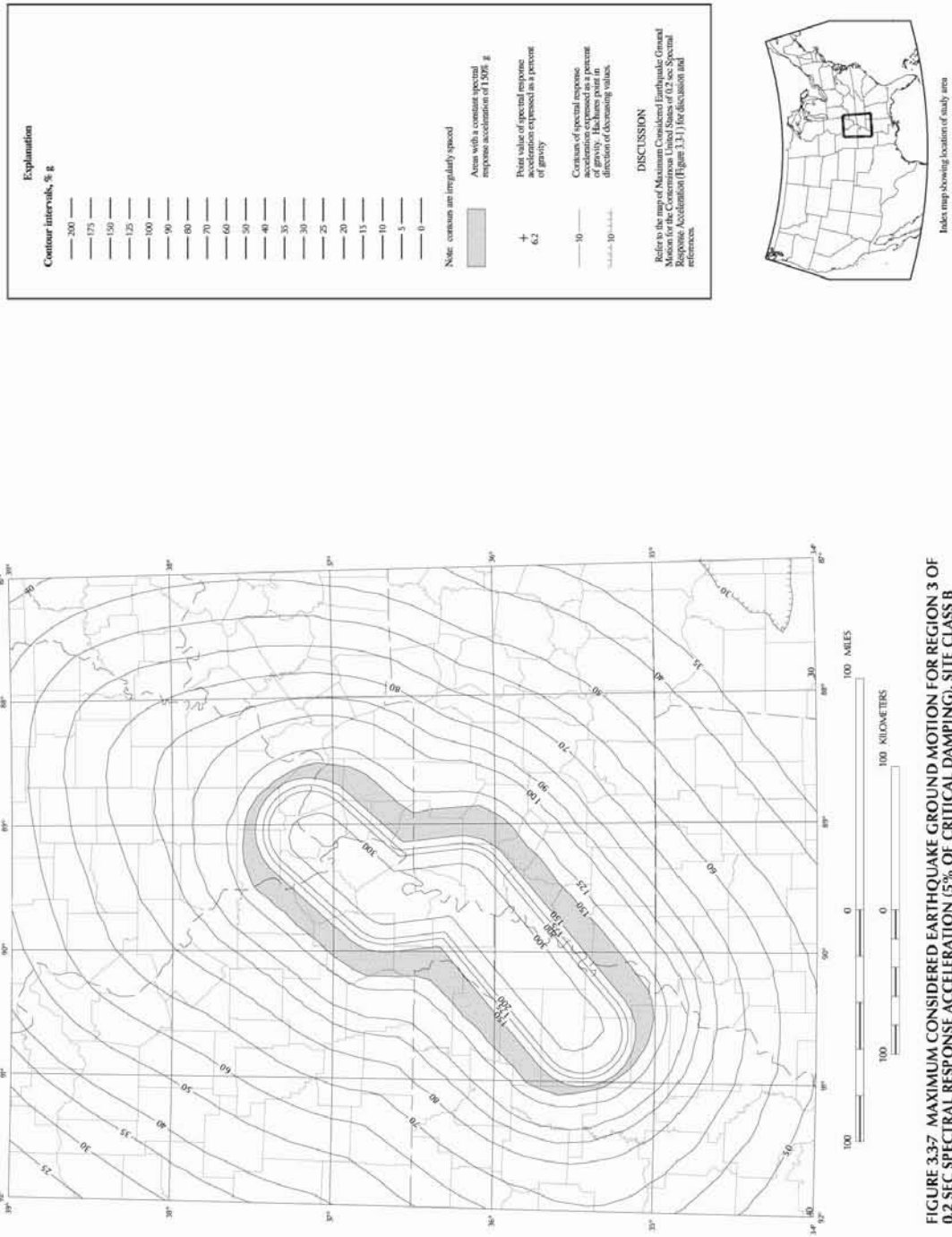

FIGURE 3.37 MAXIMUM CONSIDERED EARTHQUAKE GROUND MOTION FOR REGION 3 OF 0.2 SEC SPECTRAL RESPONSE ACCELERATION (5% OF CRITICAL DAMPING), SITE CLASS B

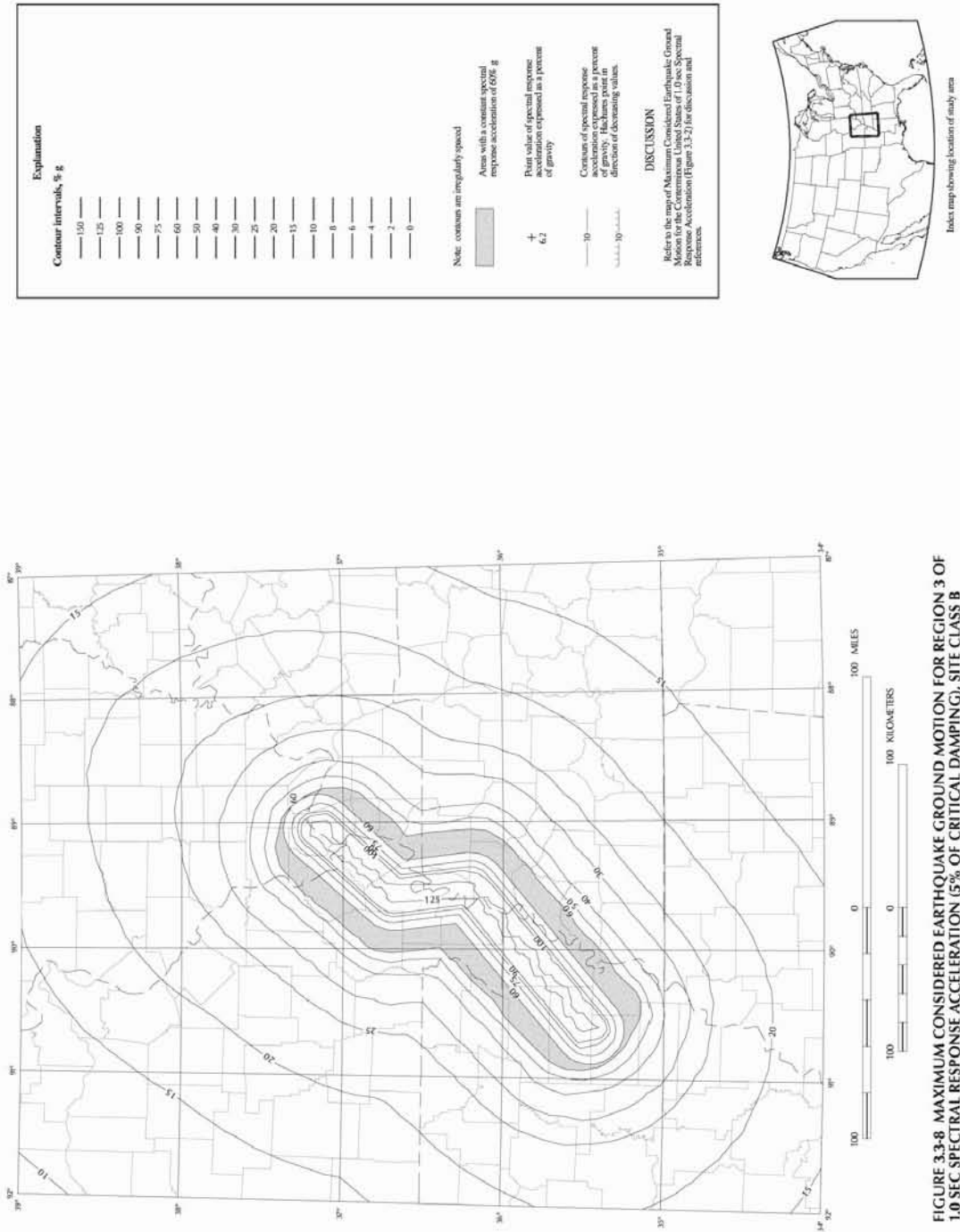

FIGURE 3.3-8 MAXIMUM CONSIDERED EARTHQUAKE GROUND MOTION FOR REGION 3 OF 1.0 SEC SPECTRAL RESPONSE ACCELERATION (5% OF CRITICAL DAMPING), SITE CLASS B

FIGURE 3.3-9 MAXIMUM CONSIDERED EARTHQUAKE GROUND MOTION FOR REGION 4 OF 0.2 AND 1.0 SEC SPECTRAL RESPONSE ACCELERATION (5% OF CRITICAL DAMPING), SITE CLASS B

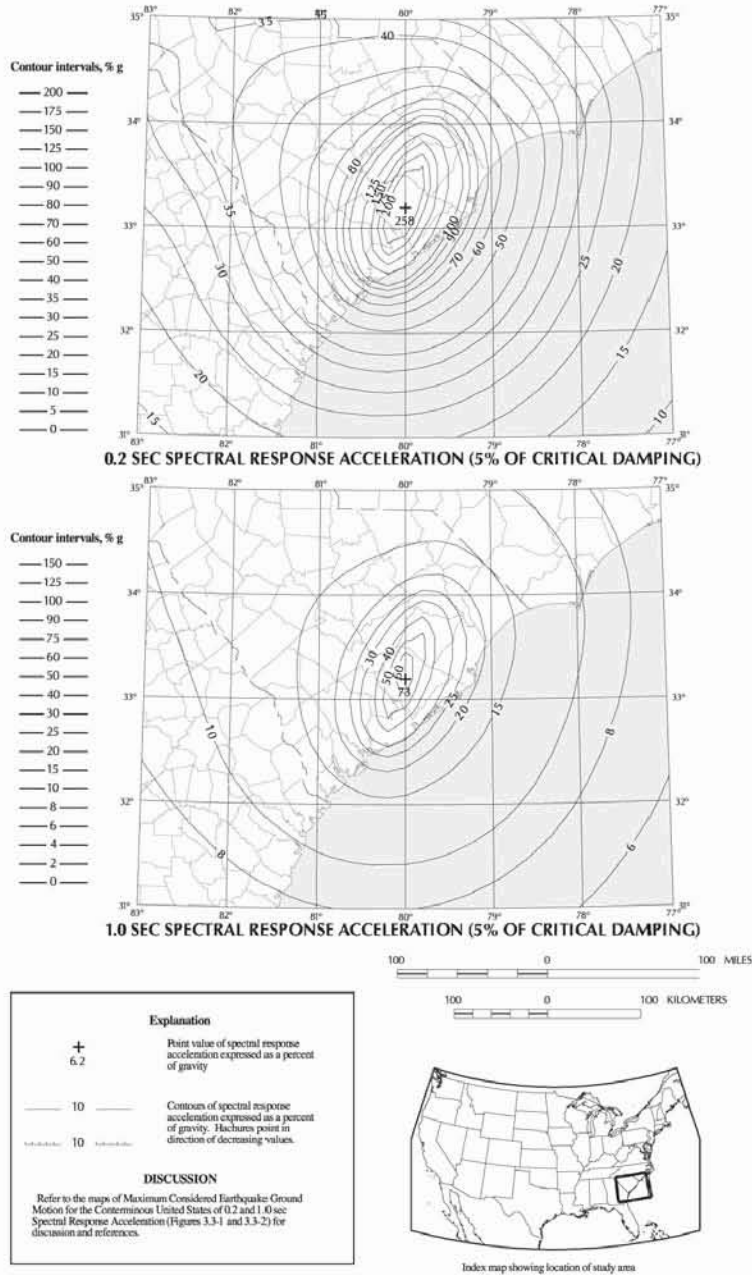

FIGURE 3.3-10 MAXIMUM CONSIDERED EARTHQUAKE GROUND MOTION FOR HAWAII OF 0.2 AND 1.0 SEC SPECTRAL RESPONSE ACCELERATION (5% OF CRITICAL DAMPING), SITE CLASS B

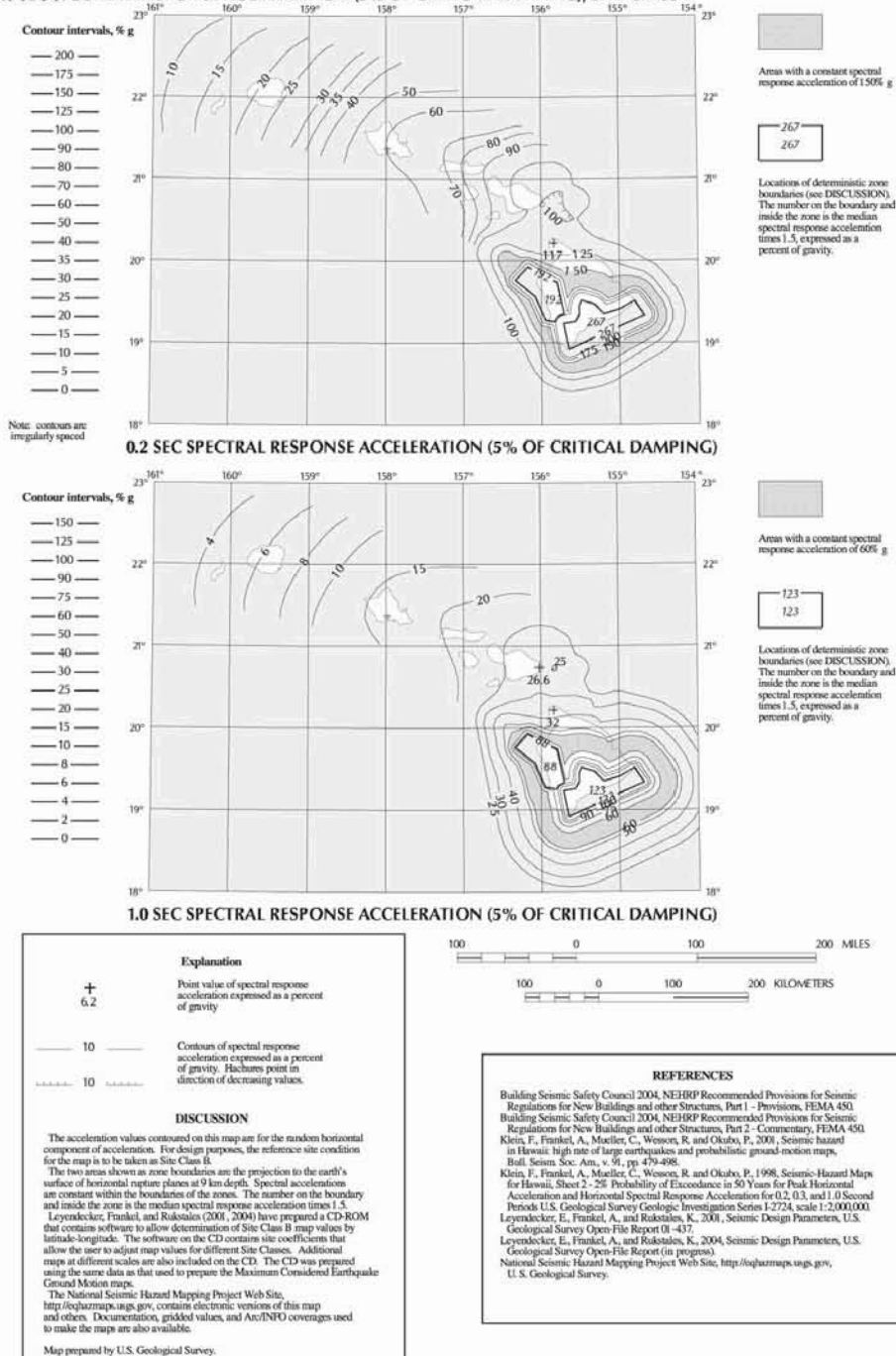

FIGURE 3.3-11 MAXIMUM CONSIDERED EARTHQUAKE GROUND MOTION FOR ALASKA OF 0.2 SEC SPECTRAL RESPONSE ACCELERATION (5% OF CRITICAL DAMPING), SITE CLASS B

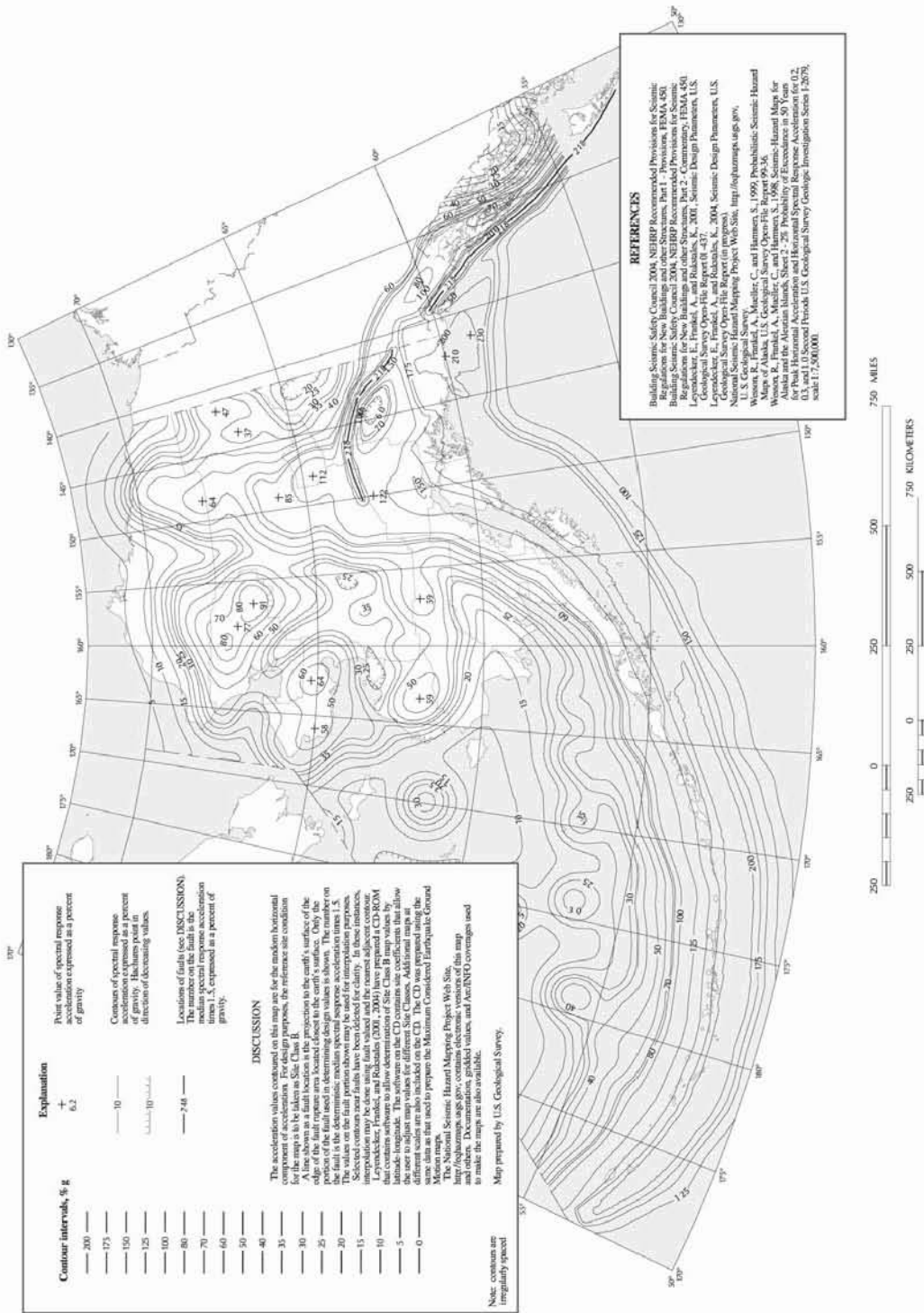

FIGURE 3.3-12 MAXIMUM CONSIDERED EARTHQUAKE GROUND MOTION FOR ALASKA OF 1.0 SEC SPECTRAL RESPONSE ACCELERATION (5% OF CRITICAL DAMPING), SITE CLASS B

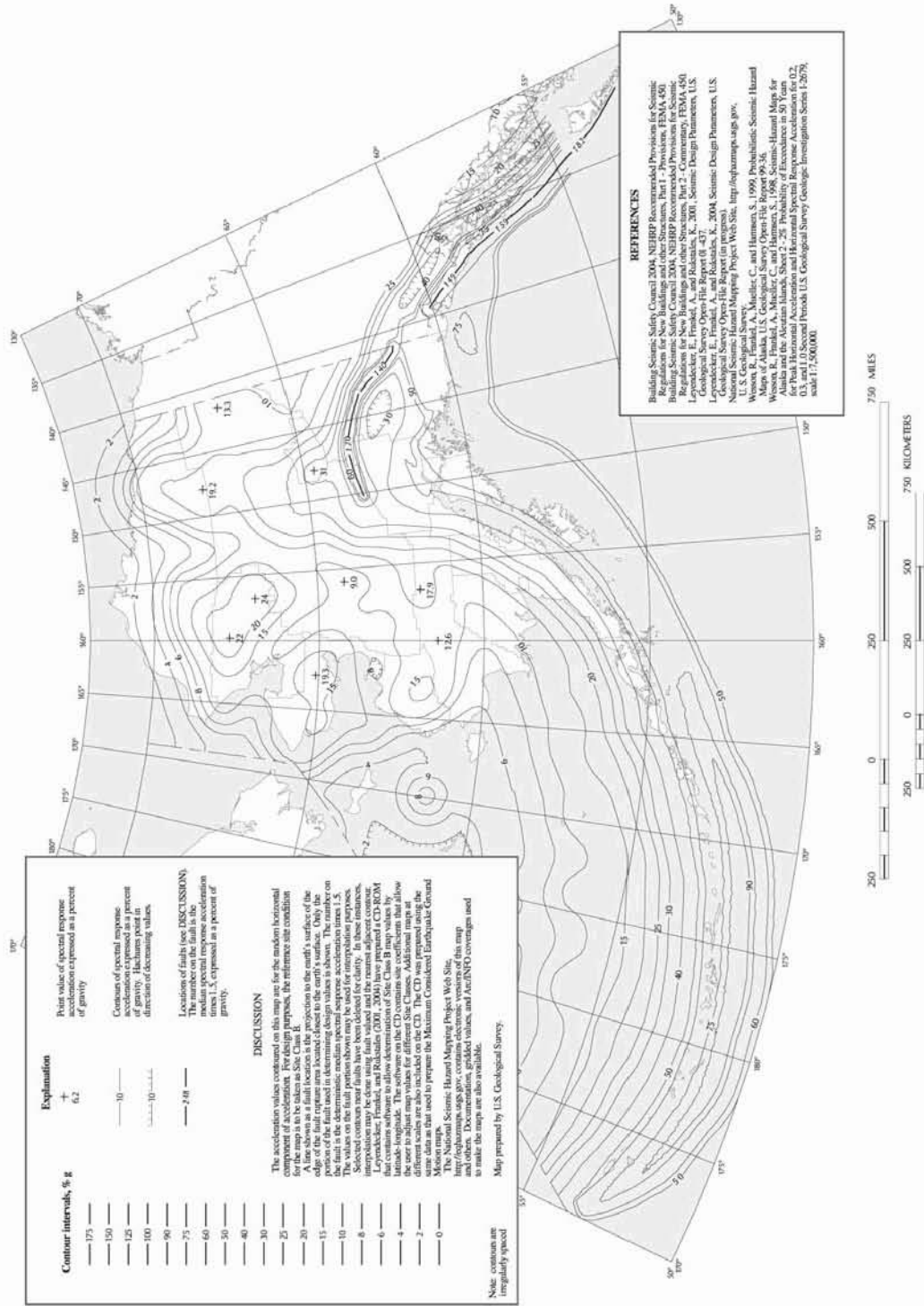
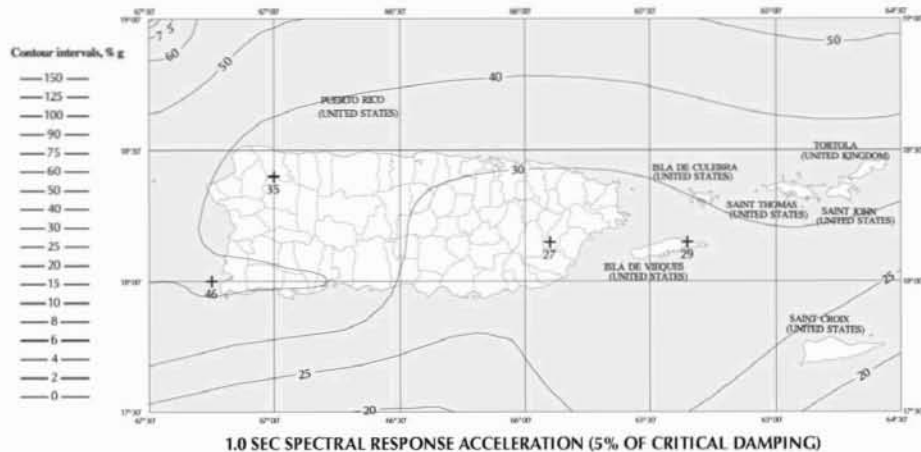
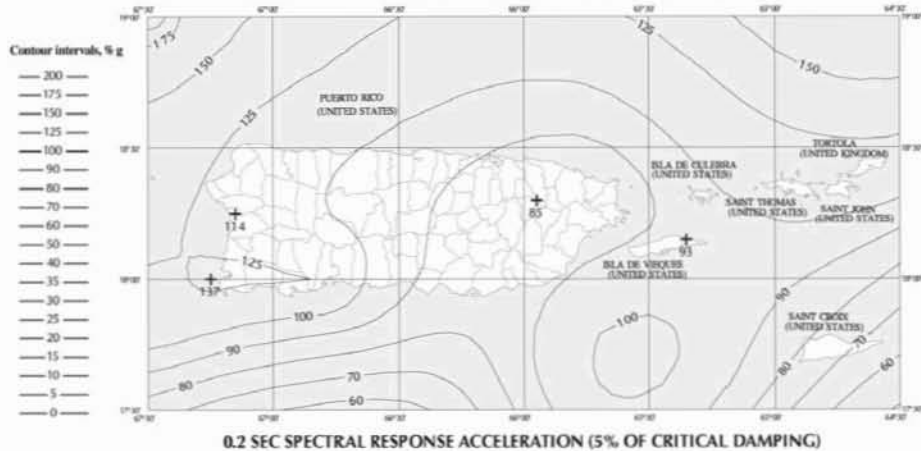

FIGURE 3.3-13 MAXIMUM CONSIDERED EARTHQUAKE GROUND MOTION FOR PUERTO RICO, CULEBRA, VIEQUES, ST. THOMAS, ST. JOHN, AND ST. CROIX OF 0.2 AND 1.0 SEC SPECTRAL RESPONSE ACCELERATION (5% OF CRITICAL DAMPING), SITE CLASS B



Explanation

6.2 Point value of spectral response acceleration expressed as a percent of gravity.
 10 Contours of spectral response acceleration expressed as a percent of gravity. Hashmarks point in direction of decreasing values.
 10 Contours of spectral response acceleration expressed as a percent of gravity. Hashmarks point in direction of decreasing values.

DISCUSSION

The acceleration values contoured on this map are for the random horizontal component of acceleration. For design purposes, the reference site condition for the map is to be taken as Site Class B.

Leyendecker, Frankel, and Rukstales (2001, 2004) have prepared a CD-ROM that contains software to allow determination of Site Class B map values by latitude-longitude. The software on the CD contains site coefficients that allow the user to adjust map values for different Site Classes. Additional maps at different scales are also included on the CD. The CD was prepared using the same data as that used to prepare the Maximum Considered Earthquake Ground Motion maps.

The National Seismic Hazard Mapping Project Web Site, <http://eqhazmaps.usgs.gov>, contains electronic versions of this map and other documentation, grid values, and Arc/INFO coverages used to make the maps are also available.

Map prepared by U.S. Geological Survey.



REFERENCES

Building Seismic Safety Council 2004. NEHRP Recommended Provisions for Seismic Regulations for New Buildings and other Structures, Part 1 - Provisions, FEMA 450.

Building Seismic Safety Council 2004. NEHRP Recommended Provisions for Seismic Regulations for New Buildings and other Structures, Part 2 - Commentary, FEMA 450.

Leyendecker, E., Frankel, A., and Rukstales, K., 2001. Seismic Design Parameters, U.S. Geological Survey Open-File Report 01-437.

Leyendecker, E., Frankel, A., and Rukstales, K., 2004. Seismic Design Parameters, U.S. Geological Survey Open-File Report (in progress).

Mueller, C., Frankel, A., Petersen, M., and Leyendecker, E., 2003. Documentation for 2003 USGS Seismic Hazard Maps for Puerto Rico and the U.S. Virgin Islands, U.S. Geological Survey Open-File Report 03-379.

Mueller, C., Frankel, A., Petersen, M., and Leyendecker, E., 2004. Seismic-Hazard Maps for Puerto Rico and the U.S. Virgin Islands, Sheet 2 - 2% Probability of Exceedance in 50 Years for Peak Horizontal Acceleration and Horizontal Spectral Response Acceleration for 0.2, 0.3, and 1.0 Second Periods, U.S. Geological Survey Geologic Investigation Series (in progress).

National Seismic Hazard Mapping Project Web Site, <http://eqhazmaps.usgs.gov>, U.S. Geological Survey.

FIGURE 3.3-14 MAXIMUM CONSIDERED EARTHQUAKE GROUND MOTION FOR GUAM AND TUTUILA OF 0.2 AND 1.0 SEC SPECTRAL RESPONSE ACCELERATION (5% OF CRITICAL DAMPING), SITE CLASS B

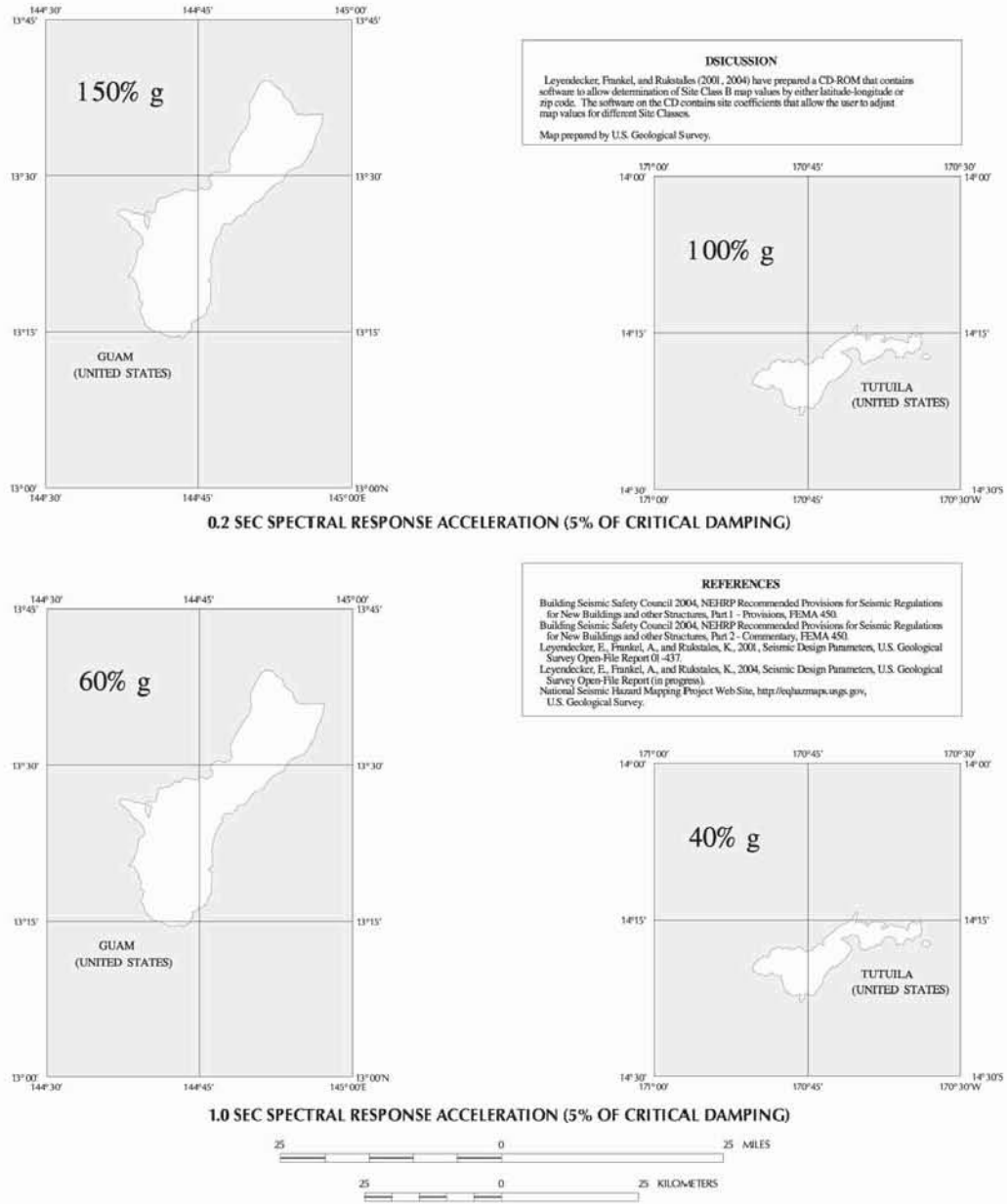

Table 3.3-2 Values of Site Coefficient F_v

Site Class	Mapped MCE Spectral Response Acceleration Parameter at 1 Second Period ^a				
	$S_I \leq 0.1$	$S_I = 0.2$	$S_I = 0.3$	$S_I = 0.4$	$S_I \geq 0.5$
A	0.8	0.8	0.8	0.8	0.8
B	1.0	1.0	1.0	1.0	1.0
C	1.7	1.6	1.5	1.4	1.3
D	2.4	2.0	1.8	1.6	1.5
E	3.5	3.2	2.8	2.4	2.4
F	— ^b	— ^b	— ^b	— ^b	— ^b

^a Use straight line interpolation for intermediate values of S_I .
^b Site-specific geotechnical investigation and dynamic site response analyses shall be performed.

3.3.3 Design acceleration parameters. The parameters S_{DS} and S_{DI} shall be determined from Eq. 3.3-3 and 3.3-4, respectively:

$$S_{DS} = \frac{2}{3} S_{MS} \quad (3.3-3)$$

and

$$S_{DI} = \frac{2}{3} S_{MI} \quad (3.3-4)$$

3.3.4 Design response spectrum. Where a design response spectrum is required by these *Provisions* and site-specific procedures are not used, the design response spectrum shall be developed as indicated in Figure 3.3-15 and as follows:

1. For periods less than or equal to T_0 , S_a shall be taken as given by Eq. 3.3-5:

$$S_a = 0.6 \frac{S_{DS}}{T_0} T + 0.4 S_{DS} \quad (3.3-5)$$

2. For periods greater than or equal to T_0 and less than or equal to T_S , S_a shall be taken as equal to S_{DS} .
3. For periods greater than T_S and less than or equal to T_L , S_a shall be taken as given by Eq. 3.3-6:

$$S_a = \frac{S_{DI}}{T} \quad (3.3-6)$$

4. For periods greater than T_L , S_a shall be taken as given by Eq. 3.3-7.

$$S_a = \frac{S_{DI} T_L}{T^2} \quad (3.3-7)$$

where:

S_{DS} = the design spectral response acceleration parameter at short periods

S_{DI} = the design spectral response acceleration parameter at 1 second period

T = the fundamental period of the structure (sec)

T_0 = $0.2 S_{DI} / S_{DS}$

T_S = S_{DI} / S_{DS}

T_L = Long-period transition period shown in Figure 3.3-16 (conterminous U.S. except California), Figure 3.3-17 (California), Figure 3.3-18 (Alaska), Figure 3.3-19 (Hawaii), Figure 3.3-20 (Puerto Rico), and Figure 3.3-21 (Guam and Tutuila).

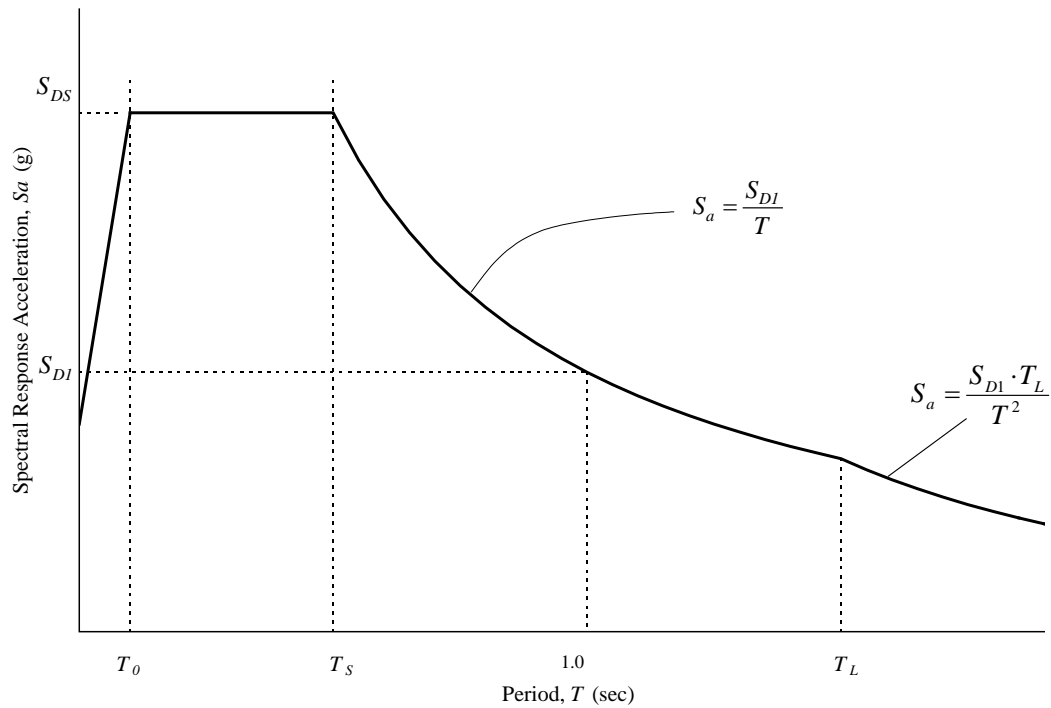

Figure 3.3-15 Long-Period transition Period.

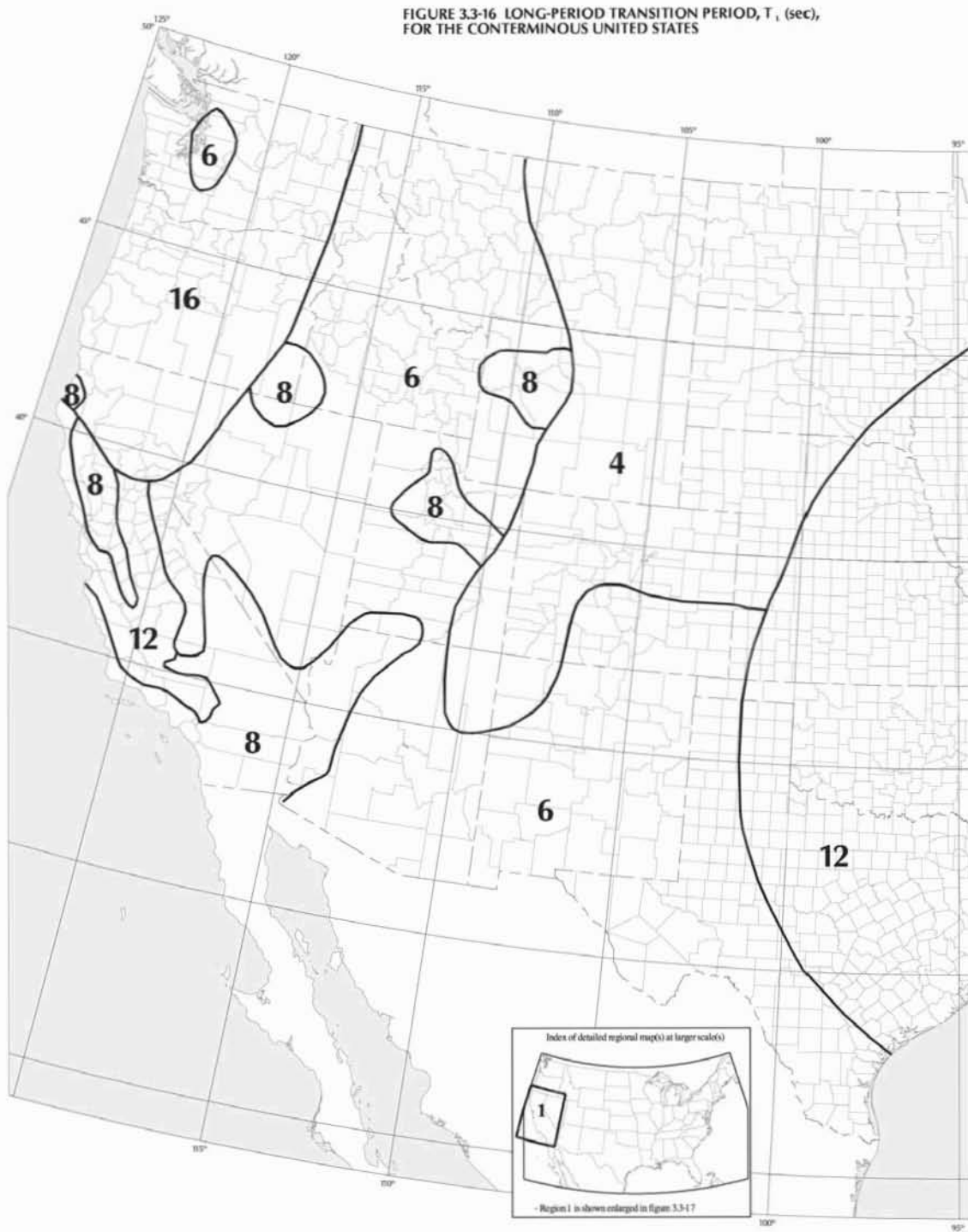
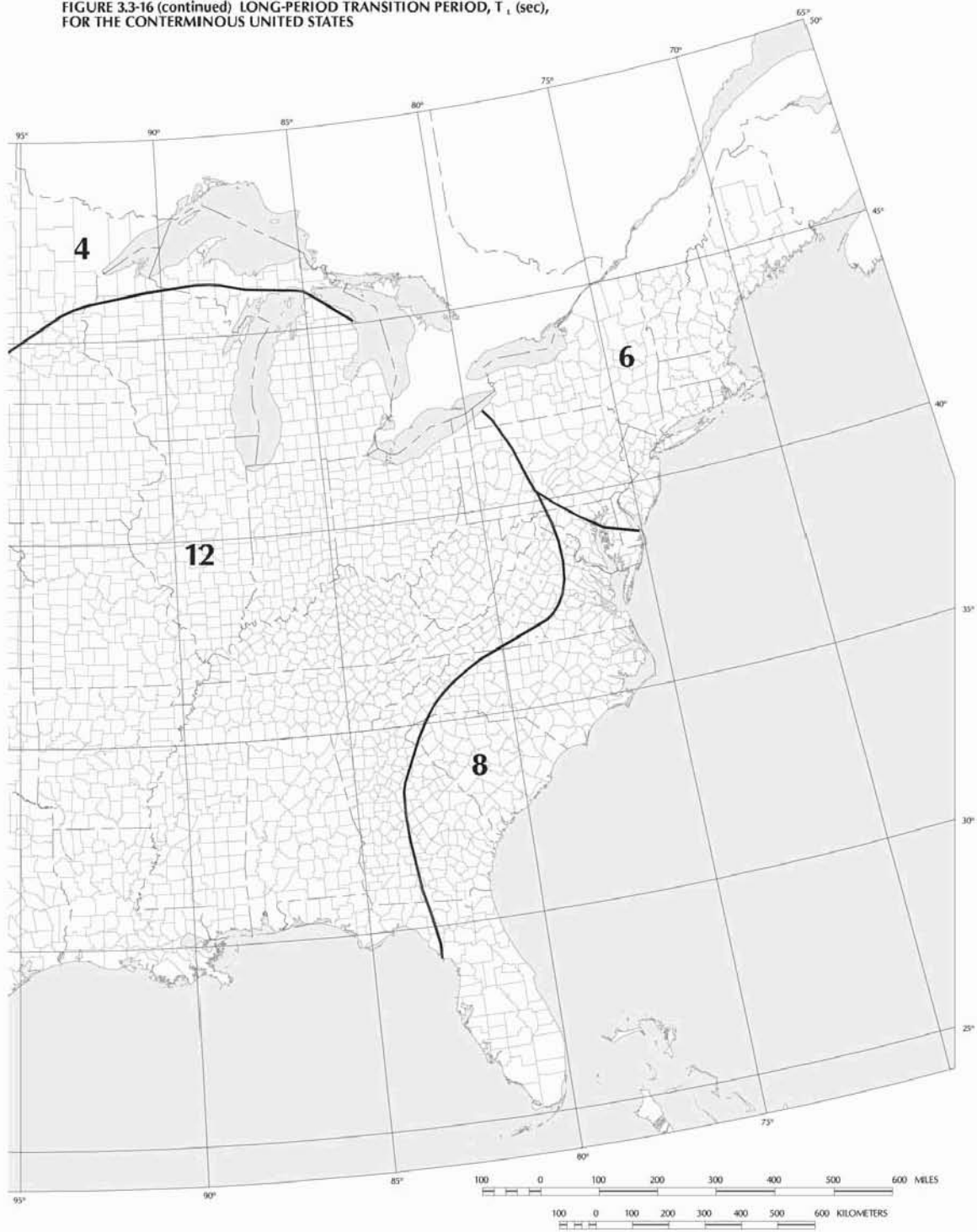
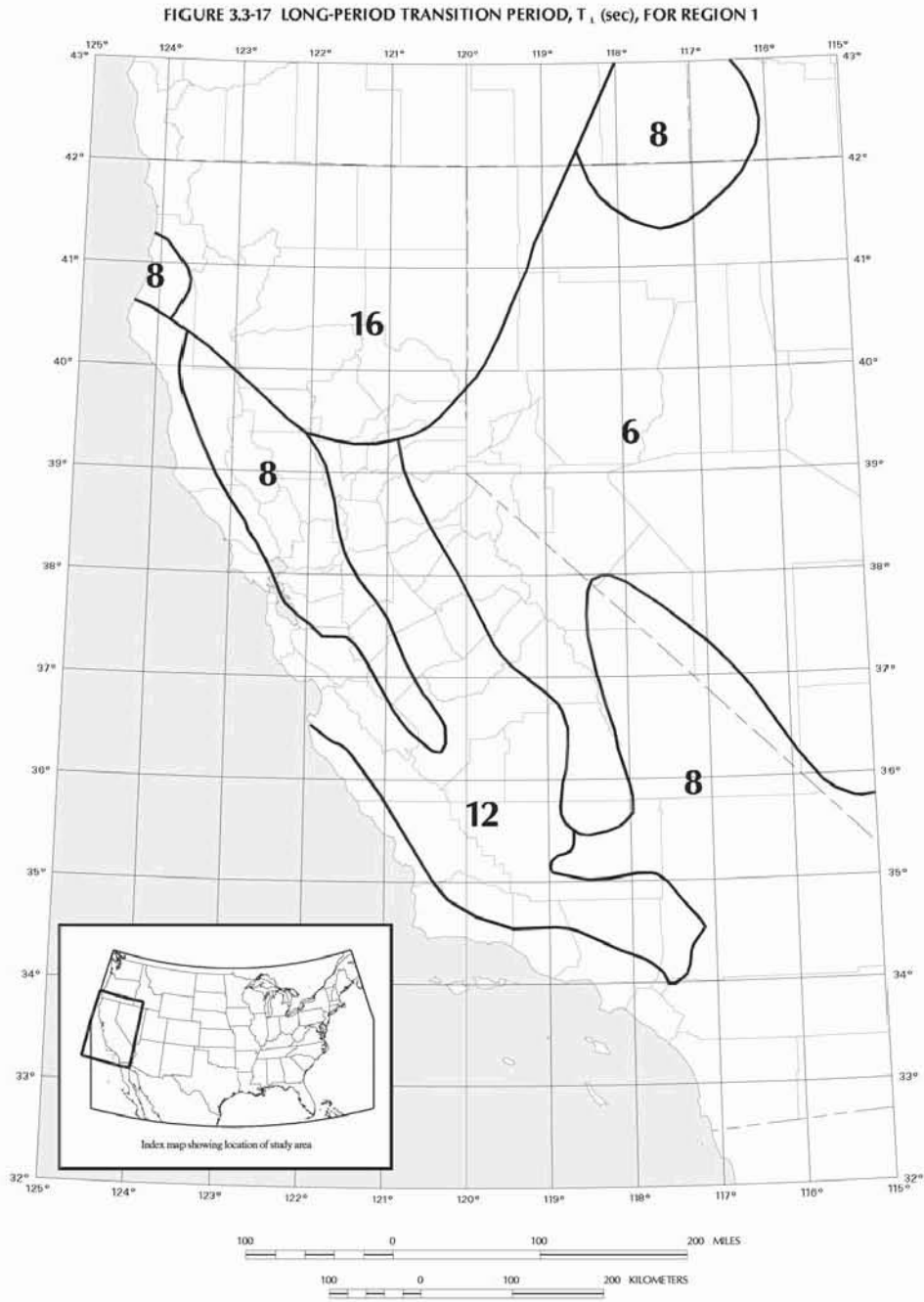

FIGURE 3.3-16 (continued) LONG-PERIOD TRANSITION PERIOD, T_L (sec), FOR THE CONTERMINOUS UNITED STATES





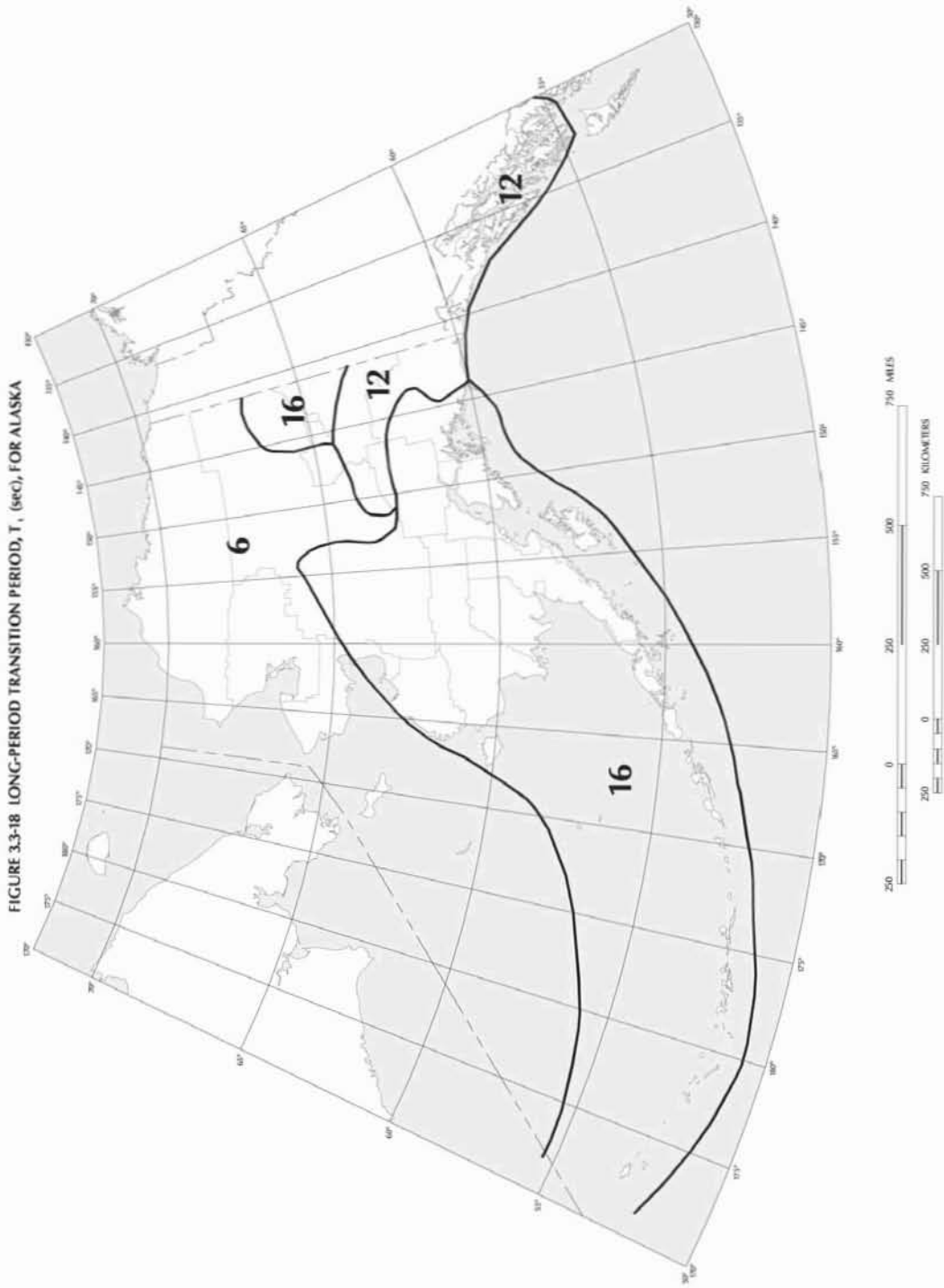

FIGURE 3.3-18 LONG-PERIOD TRANSITION PERIOD, T , (SEC), FOR ALASKA

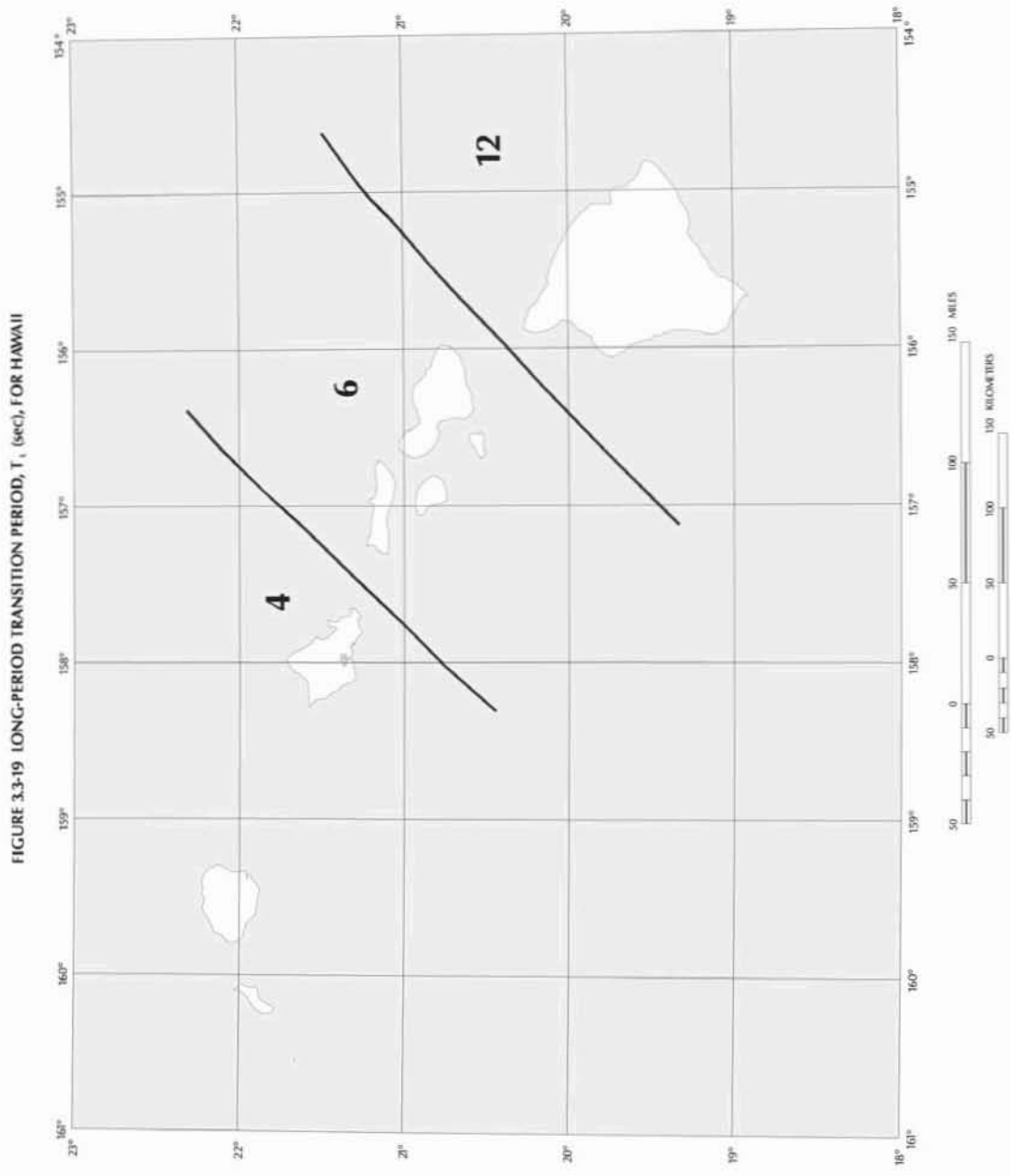

FIGURE 3.3-20 LONG-PERIOD TRANSITION PERIOD, T_i (sec), FOR PUERTO RICO, CULEBRA, VIEQUES, ST. THOMAS, ST. JOHN, AND ST. CROIX

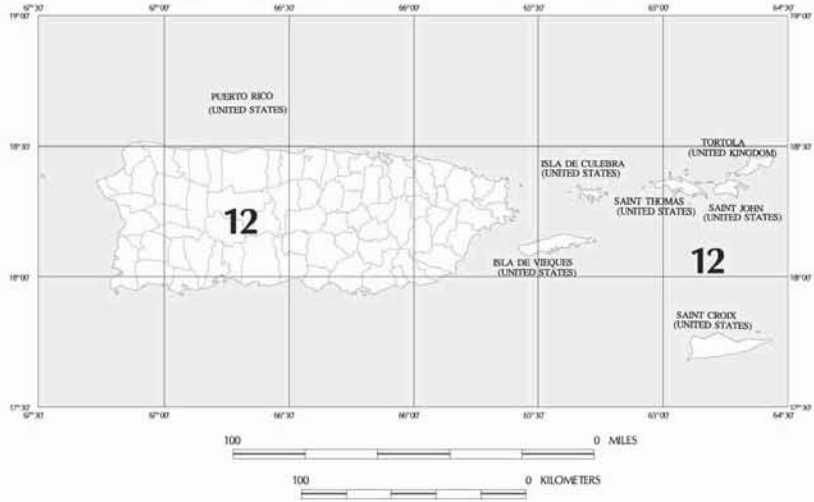
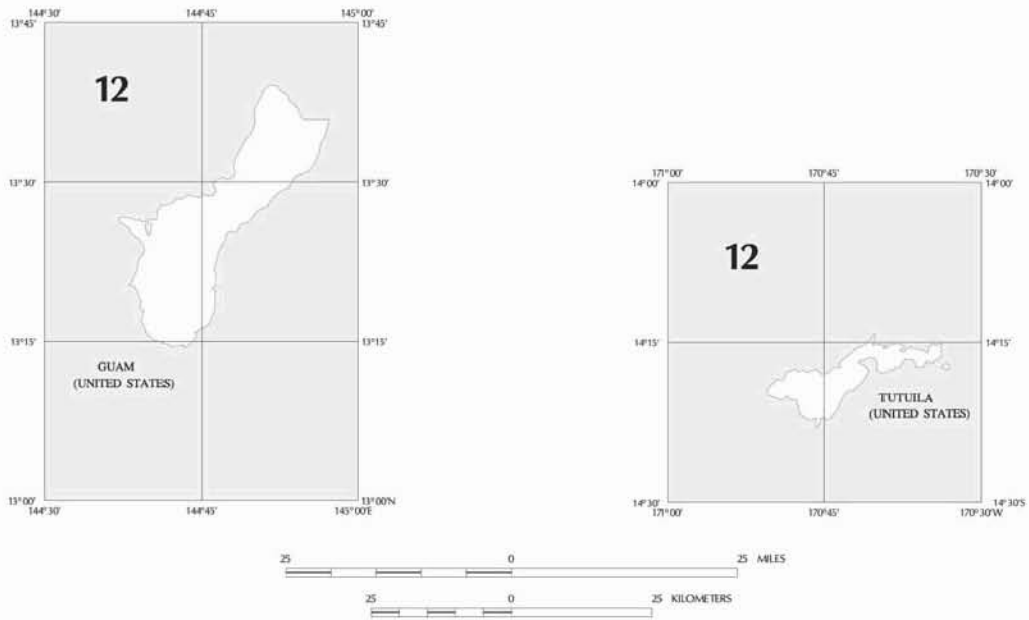

FIGURE 3.3-21 LONG-PERIOD TRANSITION PERIOD, T_i (sec), FOR GUAM AND TUTUILA



3.4 SITE-SPECIFIC PROCEDURE

A site-specific study shall account for the regional tectonic setting, geology, and seismicity, the expected recurrence rates and maximum magnitudes of earthquakes on known faults and source zones, the characteristics of ground motion attenuation, near-fault effects if any on ground motions, and the effects of subsurface site conditions on ground motions. The study shall incorporate current scientific interpretations, including uncertainties, for models and parameter values for seismic sources and ground motions. The study shall be documented in a report.

3.4.1 Probabilistic maximum considered earthquake. Where site-specific procedures are utilized, the probabilistic maximum considered earthquake ground motion shall be taken as that motion represented by a 5-percent-damped acceleration response spectrum having a 2 percent probability of exceedance in a 50 year period.

3.4.2 Deterministic maximum considered earthquake. The deterministic maximum considered earthquake spectral response acceleration at each period shall be taken as 150 percent of the largest median 5-percent-damped spectral response acceleration computed at that period for characteristic earthquakes on all known active faults within the region. For the purposes of these *Provisions*, the ordinates of the deterministic maximum considered earthquake ground motion response spectrum shall not be taken lower than the corresponding ordinates of the response spectrum determined in accordance with Figure 3.4-1, where F_a and F_v are determined using Tables 3.3-1 and 3.3-2, with the value of S_S taken as 1.5 and the value of S_I taken as 0.6.

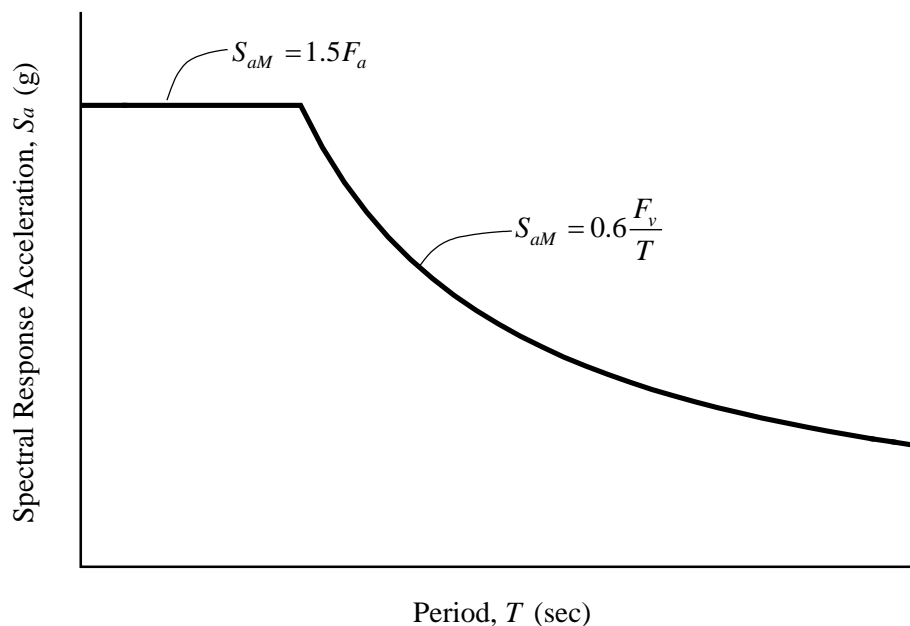

Figure 3.4-1 Deterministic Lower Limit on Maximum Considered Earthquake

3.4.3 Site-specific maximum considered earthquake. The site-specific maximum considered earthquake spectral response acceleration at any period, S_{aM} , shall be taken as the lesser of the spectral response accelerations from the probabilistic maximum considered earthquake ground motion of Sec. 3.4.1 and the deterministic maximum considered earthquake ground motion of Sec. 3.4.2.

3.4.4 Design response spectrum. Where site-specific procedures are used to determine the maximum considered earthquake ground motion, the design spectral response acceleration at any period shall be determined from Eq. 3.4-1:

$$S_a = \frac{2}{3} S_{aM} \quad (3.4-1)$$

and shall be greater than or equal to 80 percent of S_a determined in accordance with Sec. 3.3.4. For sites classified as Site Class F requiring site-specific evaluations (Note b to Tables 3.3-1 and 3.3-2 and Sec. 3.5.1), the design spectral response acceleration at any period shall be greater than or equal to 80 percent of S_a determined for Site Class E in accordance with Sec. 3.3.4.

3.4.5 Design acceleration parameters. Where the site-specific procedure is used to determine the design response spectrum in accordance with Section 3.4.4, the parameter S_{DS} shall be taken as the spectral acceleration, S_a , obtained from the site-specific spectrum at a period of 0.2 second, except that it shall not be taken as less than 90 percent of the peak spectral acceleration, S_a , at any period larger than 0.2 second. The parameter S_{DI} shall be taken as the greater of the spectral acceleration, S_a , at a period of 1 second or two times the spectral acceleration, S_a , at a period 2 seconds. The parameters S_{MS} and S_{MI} shall be taken as 1.5 times S_{DS} and S_{DI} , respectively. The values so obtained shall not be taken as less than 80 percent of the values obtained from the general procedure of Section 3.3.

3.5 SITE CLASSIFICATION FOR SEISMIC DESIGN

Where the soil properties are not known in sufficient detail to determine the Site Class in accordance with Sec. 3.5.1, it shall be permitted to assume Site Class D unless the authority having jurisdiction determines that Site Class E or F could apply at the site or in the event that Site Class E or F is established by geotechnical data.

3.5.1 Site Class definitions. The Site Classes are defined as follows:

- A Hard rock with measured shear wave velocity, $\bar{v}_s > 5,000$ ft/sec (1500 m/s)
- B Rock with $2,500$ ft/sec $< \bar{v}_s \leq 5,000$ ft/sec (760 m/s $< \bar{v}_s \leq 1500$ m/s)
- C Very dense soil and soft rock with $1,200$ ft/sec $< \bar{v}_s \leq 2,500$ ft/sec (360 m/s $< \bar{v}_s \leq 760$ m/s) or with either $\bar{N} > 50$ or $\bar{s}_u > 2,000$ psf (100 kPa)
- D Stiff soil with 600 ft/sec $\leq \bar{v}_s \leq 1,200$ ft/sec (180 m/s $\leq \bar{v}_s \leq 360$ m/s) or with either $15 \leq \bar{N} \leq 50$ or $1,000$ psf $\leq \bar{s}_u \leq 2,000$ psf (50 kPa $\leq \bar{s}_u \leq 100$ kPa)
- E A soil profile with $\bar{v}_s < 600$ ft/sec (180 m/s) or with either $\bar{N} < 15$, $\bar{s}_u < 1,000$ psf, or any profile with more than 10 ft (3 m) of soft clay defined as soil with $PI > 20$, $w \geq 40$ percent, and $s_u < 500$ psf (25 kPa)
- F Soils requiring site-specific evaluations:
 1. Soils vulnerable to potential failure or collapse under seismic loading such as liquefiable soils, quick and highly sensitive clays, collapsible weakly cemented soils.

Exception: For structures having fundamental periods of vibration less than or equal to 0.5 second, site-specific evaluations are not required to determine spectral accelerations for liquefiable soils. Rather, the Site Class may be determined in accordance with Sec. 3.5.2, assuming liquefaction does not occur, and the corresponding values of F_a and F_v determined from Tables 3.3-1 and 3.3-2.
 2. Peat and/or highly organic clays ($H > 10$ ft [3 m] of peat and/or highly organic clay, where H = thickness of soil)
 3. Very high plasticity clays ($H > 25$ ft [8 m] with $PI > 75$)
 4. Very thick, soft/medium stiff clays ($H > 120$ ft [36 m]) with $s_u < 1,000$ psf (50 kPa)

The parameters used to define the Site Class are based on the upper 100 ft (30 m) of the site profile. Profiles containing distinctly different soil and rock layers shall be subdivided into those layers

designated by a number that ranges from 1 to n at the bottom where there are a total of n distinct layers in the upper 100 ft (30 m). The symbol i then refers to any one of the layers between 1 and n .

where:

v_{si} = the shear wave velocity in ft/sec (m/s).

d_i = the *thickness* of any layer (between 0 and 100 ft [30 m]).

$$\bar{v}_s = \frac{\sum_{i=1}^n d_i}{\sum_{i=1}^n \frac{d_i}{v_{si}}} \quad (3.5-1)$$

where $\sum_{i=1}^n d_i$ is equal to 100 ft (30 m).

N_i = the Standard Penetration Resistance determined in accordance with ASTM D 1586, as directly measured in the field without corrections, and shall not be taken greater than 100 blows/ft. Where refusal is met for a rock layer, N_i shall be taken as 100 blows/ft.

$$\bar{N} = \frac{\sum_{i=1}^n d_i}{\sum_{i=1}^n \frac{d_i}{N_i}} \quad (3.5-2)$$

where N_i and d_i in Eq. 3.5-2 are for cohesionless soil, cohesive soil, and rock layers.

$$\bar{N}_{ch} = \frac{d_s}{\sum_{i=1}^m \frac{d_i}{N_i}} \quad (3.5-3)$$

where N_i and d_i in Eq. 3.5-3 are for cohesionless soil layers only,

$$\text{and } \sum_{i=1}^m d_i = d_s$$

d_s = the total thickness of cohesionless soil layers in the top 100 ft (30 m).

s_{ui} = the undrained shear strength in psf (kPa), determined in accordance with ASTM D 2166 or D 2850, and shall not be taken greater than 5,000 psf (250 kPa).

$$\bar{s}_u = \frac{d_c}{\sum_{i=1}^k \frac{d_i}{s_{ui}}} \quad (3.5-4)$$

where $\sum_{i=1}^k d_i = d_c$.

d_c = the total thickness of cohesive soil layers in the top 100 ft (30 m).

PI = the plasticity index, determined in accordance with ASTM D 4318.

w = the moisture content in percent, determined in accordance with ASTM D 2216.

3.5.2 Steps for classifying a site

Step 1: Check for the four categories of Site Class F requiring site-specific evaluation. If the site corresponds to any of these categories, classify the site as Site Class F and conduct a site-specific evaluation.

Step 2: Check for the existence of a total thickness of soft clay > 10 ft (3 m) where a soft clay layer is defined by: $s_u < 500$ psf (25 kPa), $w \geq 40$ percent, and $PI > 20$. If these criteria are satisfied, classify the site as Site Class E.

Step 3: Categorize the site using one of the following three methods with \bar{v}_s , \bar{N} and \bar{s}_u computed in all cases as specified in Sec. 3.5.1:

- \bar{v}_s for the top 100 ft (30 m) (\bar{v}_s method)
- \bar{N} for the top 100 ft (30 m) (\bar{N} method)
- \bar{N}_{ch} for cohesionless soil layers ($PI < 20$) in the top 100 ft (30 m) and average \bar{s}_u for cohesive soil layers ($PI > 20$) in the top 100 ft (30 m) (\bar{s}_u method)

Table 3.5-1 Site Classification

Site Class	\bar{v}_s	\bar{N} or \bar{N}_{ch}	\bar{s}_u^a
E	< 600 fps (< 180 m/s)	< 15	< 1,000 psf (< 50 kPa)
D	600 to 1,200 fps (180 to 360 m/s)	15 to 50	1,000 to 2,000 psf (50 to 100 kPa)
C	> 1,200 to 2,500 fps (360 to 760 m/s)	> 50	> 2,000 (> 100 kPa)

^a If the \bar{s}_u method is used and the \bar{N}_{ch} and \bar{s}_u criteria differ, select the category with the softer soils (for example, use Site Class E instead of D).

Assignment of Site Class B shall be based on the shear wave velocity for rock. For competent rock with moderate fracturing and weathering, estimation of this shear wave velocity shall be permitted. For more highly fractured and weathered rock, the shear wave velocity shall be directly measured or the site shall be assigned to Site Class C.

Assignment of Site Class A shall be supported by either shear wave velocity measurements on site or shear wave velocity measurements on profiles of the same rock type in the same formation with an equal or greater degree of weathering and fracturing. Where hard rock conditions are known to be continuous to a depth of 100 ft (30 m), surficial shear wave velocity measurements may be extrapolated to assess \bar{v}_s .

Site Classes A and B shall not be used where there is more than 10 ft (3 m) of soil between the rock surface and the bottom of the spread footing or mat foundation.

This page is intentionally left blank.

Chapter 4

STRUCTURAL DESIGN CRITERIA

4.1 GENERAL

4.1.1 Scope. The structural design criteria to be used in the design of buildings and other structures and their components shall be as prescribed in this chapter. As an alternative, the seismic analysis and design procedures of Alternative Simplified Chapter 4 shall be permitted to be used in lieu of the requirements of this chapter, subject to all of the limitations contained in the Alternate Chapter 4.

4.1.2 References. The following reference documents shall be used as indicated in this chapter.

- ACI 318 *Building Code Requirements for Structural Concrete*, American Concrete Institute, 1999, excluding Appendix A.
- AISC ASD *Allowable Stress Design and Plastic Design Specification for Structural Steel Buildings*, American Institute of Steel Construction, 1989.
- AISC LRFD *Load and Resistance Factor Design Specification for Structural Steel Buildings*, American Institute of Steel Construction, 1993.
- AISC Seismic *Seismic Provisions for Structural Steel Buildings*, Part I, American Institute of Steel Construction, 1997, including Supplement No. 2 (2000).
- AISI *Specification for the Design of Cold-formed Steel Structural Members*, American Iron and Steel Institute, 1996, including Supplement No. 1 (2000).
- ASCE 7 *Minimum Design Loads for Buildings and Other Structures*, American Society of Civil Engineers, 1998.

4.1.3 Definitions

Base: The level at which the horizontal seismic ground motions are considered to be imparted to the structure.

Base shear: Total design lateral force at the base.

Bearing wall: An exterior or interior wall providing support for vertical loads.

Bearing wall system: A structural system with bearing walls providing support for all or major portions of the vertical loads. Shear walls or braced frames provide seismic-force resistance.

Braced frame: An essentially vertical truss that is provided to resist the effects of horizontal loads.

Building: Any structure whose use could include shelter of human occupants.

Building frame system: A structural system with an essentially complete space frame system providing support for vertical loads. Seismic-force resistance is provided by shear walls or braced frames.

Cantilevered column system: A seismic-force-resisting system in which lateral forces are resisted entirely by columns acting as cantilevers from the foundation.

Collector: See drag strut.

Component: See Sec. 1.1.4.

Concentrically braced frame (CBF): A braced frame in which the members are subjected primarily to axial forces.

Dead load: The gravity load due to the weight of all permanent structural and nonstructural components such as walls, floors, roofs, and the operating weight of fixed service equipment.

Design strength: Nominal strength multiplied by the strength reduction factor, ϕ .

Diaphragm: A roof, floor, or other membrane system acting to transfer lateral forces to the vertical resisting elements. Diaphragms are classified as either flexible or rigid according to the requirements of Sec. 4.3.2.1 and 12.4.1.1.

Drag strut: A diaphragm or shear wall boundary element parallel to the applied load that collects and transfers diaphragm shear forces to the vertical force-resisting elements or distributes forces within the diaphragm or shear wall.

Dual frame system: A structural system with an essentially complete space frame system providing support for vertical loads. Seismic force resistance is provided by a moment resisting frame and shear walls or braced frames as prescribed in Sec. 4.3.1.1

Eccentrically braced frame (EBF): A braced frame in which at least one end of each diagonal connects to a beam a short distance from a beam-column joint or from another diagonal.

Height: Distance measured from the base of the structure as defined in sec. 4.1.3 to the roof level.

Intermediate moment frame: A moment frame of reinforced concrete satisfying the detailing requirements of ACI 318, of structural steel satisfying the detailing requirements of AISC Seismic, or of composite construction satisfying the requirements of AISC Seismic.

Inverted pendulum-type structure: Structures that have a large portion of their mass concentrated near the top and, thus, have essentially one degree of freedom in horizontal translation. The structures are usually T-shaped with a single column supporting the beams or framing at the top.

Joint: See Sec. 9.1.3.

Live load: The load superimposed by the use and/or occupancy of the structure not including the wind load, earthquake load, or dead load.

Moment frame: A frame provided with restrained connections between the beams and columns to permit the frame to resist lateral forces through the flexural rigidity and strength of its members.

Nominal strength: Strength of a member or cross section calculated in accordance with the requirements and assumptions of the strength design methods of these *Provisions* (or the reference standards) before application of any strength reduction factors.

Ordinary concentrically braced frame (OCBF): A steel concentrically braced frame in which members and connections are designed in accordance with the provisions of Ref. 8-3 without modification.

Ordinary moment frame: A moment frame of reinforced concrete conforming to the requirements of ACI 318 exclusive of Chapter 21, of structural steel satisfying the detailing requirements of AISC Seismic, or of composite construction satisfying the requirements of AISC Seismic.

Plain concrete: See Sec. 9.1.3.

Reinforced concrete: See Sec. 9.1.3.

Required strength: Strength of a member, cross section, or connection required to resist factored loads or related internal moments and forces in such combinations as stipulated by these *Provisions*.

Seismic Design Category: See Sec. 1.1.4.

Seismic-force-resisting system: See Sec. 1.1.4.

Seismic forces: See Sec. 1.1.4.

Seismic Use Group: See Sec. 1.1.4.

Shear panel: A floor, roof, or wall component sheathed to act as a shear wall or diaphragm.

Shear wall: A wall designed to resist lateral forces parallel to the plane of the wall.

Space frame system: A structural system composed of interconnected members, other than bearing walls, that is capable of supporting vertical loads and that also may provide resistance to shear.

Special concentrically braced frame (SCBF): A steel or composite steel and concrete concentrically braced frame in which members and connections are designed for ductile behavior

Special moment frame: A moment frame of reinforced concrete satisfying the detailing requirements of ACI 318, of structural steel satisfying the detailing requirements of AISC Seismic, of composite construction satisfying the requirements of AISC Seismic, or of masonry construction satisfying the requirements of Sec. 11.7.

Special Shear plate steel wall: A shear wall composed of steel webs and structural steel boundary elements.

Story: The portion of a structure between the tops of two successive finished floor surfaces or, for the topmost story, between the finished floor surface and the top of the roof structural element.

Story drift ratio: The story drift, as determined in Sec. 5.2.6, 5.3.5, or 5.4.3, divided by the story height.

Structure: See Sec. 1.1.4.

Subdiaphragm: A portion of a diaphragm used to transfer wall anchorage forces to the diaphragm cross ties.

Wall: A component that is used to enclose or divide space and is inclined at an angle of at least 60 degrees from the horizontal plane.

4.1.4 Notation

C_d The deflection amplification factor as given in Table 4.3-1.

D The effect of dead load.

E The effect of horizontal and vertical earthquake-induced forces.

F_i The portion of the seismic base shear, V , induced at Level i .

F_p The seismic design force applicable to a particular structural component.

F_{px} The diaphragm design force at Level x .

h_{sx} The story height below Level $x = h_x - h_{x-i}$.

I See Sec. 1.1.5.

Level i The building level referred to by the subscript i ; $i = 1$ designates the first level above the base.

Level n The level that is uppermost in the main portion of the of the building.

Q_E The effect of horizontal seismic forces.

R The response modification coefficient as given in Table 4.3-1.

S_{DI} See Sec. 3.1.4.

S_{DS} See Sec. 3.1.4.

T	The period of the fundamental mode of vibration of the structure in the direction of interest as determined in Sec. 5.2.2.
V_x	See Sec. 5.1.3.
W_c	Weight of wall.
W_p	Weight of structural component.
w_i	The portion of the seismic weight, W , located at or assigned to Level i .
w_{px}	The weight tributary to the diaphragm at Level x . Level x See Sec. 1.1.5.
Δ	The design story drift as determined in Sec. 5.2.6, 5.3.5, or 5.4.3.
Δ_a	The allowable story drift as specified in Sec. 4.5.1.
δ_x	The deflection of Level x at the center of the mass at and above Level x .
ρ	The redundancy factor as defined in Sec. 4.3.3.
Ω_0	Overstrength factor as given in Table 4.3-1.

4.2 GENERAL REQUIREMENTS

4.2.1 Design basis. The structure shall include complete lateral and vertical-force-resisting systems capable of providing adequate strength, stiffness, and energy dissipation capacity to withstand the design ground motions within the prescribed limits of deformation and strength demand. The design ground motions shall be assumed to occur along any direction of the structure. The adequacy of the structural systems shall be demonstrated through construction of a mathematical model and evaluation of this model for the effects of the design ground motions. This evaluation shall be based on analysis in which design seismic forces are distributed and applied throughout the height of the structure in accordance with Sec. 4.4. The corresponding structural deformations and internal forces in all members of the structure shall be determined and evaluated against acceptance criteria contained in these *Provisions*. Approved alternative procedures based on general principles of engineering mechanics and dynamics are permitted to be used to establish the seismic forces and their distribution. If an alternative procedure is used, the corresponding internal forces and deformations in the members shall be determined using a model consistent with the procedure adopted.

Individual members shall be provided with adequate strength at all sections to resist the shears, axial forces, and moments determined in accordance with these *Provisions*, and connections shall develop the strength of the connected members or the forces indicated above. The deformation of the structure shall not exceed the prescribed limits.

A continuous load path, or paths, with adequate strength and stiffness shall be provided to transfer all forces from the point of application to the final point of resistance. The foundation shall be designed to accommodate the forces developed or the movements imparted to the structure by the design ground motions. In the determination of the foundation design criteria, special recognition shall be given to the dynamic nature of the forces, the expected ground motions, and the design basis for strength and energy dissipation capacity of the structure.

The design of a structure shall consider the potentially adverse effect that the failure of a single member, connection, or component of the seismic-force-resisting system would have on the stability of the structure.

4.2.2 Combination of load effects. The effects on the structure and its components due to gravity loads and seismic forces shall be combined in accordance with the factored load combinations as presented in ASCE 7 except that the effect of seismic loads, E , shall be as defined in this section.

4.2.2.1 Seismic load effect. The effect of seismic load, E , shall be defined by Eq. 4.2-1 as follows for load combinations in which the effects of gravity loads and seismic loads are additive:

$$E = \rho Q_E + 0.2 S_{DS} D \quad (4.2-1)$$

where:

- E = the effect of horizontal and vertical earthquake-induced forces,
- ρ = the redundancy factor,
- Q_E = the effect of horizontal seismic forces,
- S_{DS} = the design spectral response acceleration parameter at short periods as defined in Sec. 3.3.3, and
- D = the effect of dead load.

The effect of seismic load, E , shall be defined by Eq. 4.2-2 as follows for load combinations in which the effects of gravity counteract seismic load:

$$E = \rho Q_E - 0.2 S_{DS} D \quad (4.2-2)$$

where E , ρ , Q_E , S_{DS} , and D are as defined above.

4.2.2.2 Seismic load effect with overstrength. Where specifically required by these *Provisions*, the design seismic force on components sensitive to the effects of structural overstrength shall be as defined by Eq. 4.2-3 and 4.2-4 for load combinations in which the effects of gravity are respectively additive with or counteractive to the effect of seismic loads:

$$E = \Omega_0 Q_E + 0.2 S_{DS} D \quad (4.2-3)$$

$$E = \Omega_0 Q_E - 0.2 S_{DS} D \quad (4.2-4)$$

where E , Q_E , S_{DS} , and D are as defined above and Ω_0 is the system overstrength factor as given in Table 4.3-1.

The term $\Omega_0 Q_E$ calculated in accordance with Eq. 4.2-3 and 4.2-4 need not exceed the maximum force that can develop in the element as determined by a rational, plastic mechanism analysis or nonlinear response analysis utilizing realistic expected values of material strengths.

4.3 SEISMIC-FORCE-RESISTING SYSTEM

4.3.1 Selection and limitations. The basic lateral and vertical seismic-force-resisting system shall conform to one of the types indicated in Table 4.3-1 subject to the system limitations and height limits, based on Seismic Design Category, indicated in the table. Each type is subdivided based on types of vertical elements used to resist lateral seismic forces. The appropriate values of R , Ω_0 , and C_d indicated in Table 4.3-1 shall be used in determining the base shear, element design forces, and design story drift as indicated in these *Provisions*.

Seismic-force-resisting systems that are not contained in Table 4.3-1 shall be permitted if analytical and test data are submitted that establish the dynamic characteristics and demonstrate the lateral force resistance and energy dissipation capacity to be equivalent to the structural systems listed in Table 4.3-1 for equivalent values of R , Ω_0 , and C_d .

Additional limitations and framing requirements are indicated in this chapter and in elsewhere in these *Provisions* for structures assigned to the various Seismic Design Categories.

Table 4.3-1 Design Coefficients and Factors for Basic Seismic-Force-Resisting Systems

Basic Seismic-Force-Resisting System	Detailing Reference Section	R^a	Ω_0^b	C_d^c	System Limitations and Height Limits (ft) by Seismic Design Category d					
					B	C	D ^e	E ^e	F ^f	
Bearing Wall Systems										
Special reinforced concrete shear walls	9.2.1.6	5	2½	5	NL	NL	160	160	160	100
Ordinary reinforced concrete shear walls	9.2.1.4	4	2½	4	NL	NL	NP	NP	NP	NP
Detailed plain concrete shear walls	9.2.1.2	2	2½	2	NL	NP	NP	NP	NP	NP
Ordinary plain concrete shear walls	9.2.1.1	1½	2½	1½	NL	NP	NP	NP	NP	NP
Intermediate precast shear walls	9.2.1.5	4	2½	4	NL	NL	40 ^k	40 ^k	40 ^k	40 ^k
Ordinary precast shear walls	9.2.1.3	3	2½	3	NL	NP	NP	NP	NP	NP
Special reinforced masonry shear walls	11.5.6.3	3½	2½	3½	NL	NL	160	160	160	100
Intermediate reinforced masonry shear walls	11.5.6.2	2½	2½	2¼	NL	NL	NP	NP	NP	NP
Ordinary reinforced masonry shear walls	11.5.6.1	2	2½	1¾	NL	NP	NP	NP	NP	NP
Detailed plain masonry shear walls	11.4.4.2	2	2½	1¾	NL	NP	NP	NP	NP	NP
Ordinary plain masonry shear walls	11.4.4.1	1½	2½	1¼	NL	NP	NP	NP	NP	NP
Prestressed masonry shear walls	11.9	1½	2½	1¾	NL	NP	NP	NP	NP	NP
Light-frame walls with shear panels	8.4, 12.3.3, 12.4	6½	3	4	NL	NL	65	65	65	65
Light-frame walls with diagonal braces	8.4.2	4	2	3½	NL	NL	65	65	65	65
Building Frame Systems										
Steel eccentrically braced frames with moment-resisting connections at columns away from links	AISC Seismic, Part I, Sec. 15	8	2	4	NL	NL	160	160	160	100

Basic Seismic-Force-Resisting System	Detailing Reference Section	R^a	Ω_0^b	C_d^c	System Limitations and Height Limits (ft) by Seismic Design Category d				
					B	C	D ^e	E ^e	F ^f
Steel eccentrically braced frames with non-moment-resisting connections at columns away from links	AISC Seismic, Part I, Sec. 15	7	2	4	NL	NL	160	160	100
Buckling-Restrained Braced Frames, non-moment-resisting beam-column connections		7	2	5½	NL	NL	160	160	100
Buckling-Restrained Braced Frames, moment-resisting Beam-column connections		8	2½	5	NL	NL	160	160	100
Special steel concentrically braced frames	AISC Seismic, Part I, Sec. 13	6	2	5	NL	NL	160	160	100
Ordinary steel concentrically braced frames	AISC Seismic, Part I, Sec. 14	5	2	4½	NL	NL	35 ^g	35 ^g	NP ^g
Special reinforced concrete shear walls	9.2.1.6	6	2½	5	NL	NL	160	160	100
Ordinary reinforced concrete shear walls	9.2.1.4	5	2½	4½	NL	NL	NP	NP	NP
Detailed plain concrete shear walls	9.2.1.2	2½	2½	2½	NL	NP	NP	NP	NP
Ordinary plain concrete shear walls	9.2.1.1	1½	2½	1½	NL	NP	NP	NP	NP
Intermediate precast shear walls	9.2.1.5	5	2½	4½	NL	NL	40 ^k	40 ^k	40 ^k
Ordinary precast shear walls	9.2.1.3	4	2½	4	NL	NP	NP	NP	NP
Composite eccentrically braced frames	AISC Seismic, Part II, Sec. 14	8	2½	4	NL	NL	160	160	100
Composite concentrically braced frames	AISC Seismic, Part II, Sec. 12	5	2	4½	NL	NL	160	160	100
Ordinary composite braced frames	AISC Seismic, Part II, Sec. 13	3	2	3	NL	NL	NP	NP	NP
Composite steel plate shear walls	AISC Seismic, Part II, Sec. 17	6½	2½	5½	NL	NL	160	160	100
Special steel plate shear walls		7	2	6	NL	NL	160	160	100
Special composite reinforced concrete shear walls with steel elements	AISC Seismic, Part II, Sec. 16	6	2½	5	NL	NL	160	160	100
Ordinary composite reinforced concrete shear walls with steel elements	AISC Seismic, Part II, Sec. 15	5	2½	4½	NL	NL	NP	NP	NP

Basic Seismic-Force-Resisting System	Detailing Reference Section	R^a	Ω_D^b	C_d^c	System Limitations and Height Limits (ft) by Seismic Design Category ^d					
					B	C	D ^e	E ^e	F ^f	
Special reinforced masonry shear walls	11.5.6.3	4½	2½	4	NL	NL	160	160	100	
Intermediate reinforced masonry shear walls	11.5.6.2	3	2½	2½	NL	NL	NP	NP	NP	
Ordinary reinforced masonry shear walls	11.5.6.1	2	2½	2	NL	NP	NP	NP	NP	
Detailed plain masonry shear walls	11.4.4.2	2	2½	2	NL	NP	Np	NP	NP	
Ordinary plain masonry shear walls	11.4.4.1	1½	2½	1¼	NL	NP	NP	NP	NP	
Prestressed masonry shear walls	11.9	1½	2½	1¾	NL	NP	NP	NP	NP	
Light-frame walls with shear panels	8.4, 12.3.3, 12.4	7	2½	4½	NL	NL	160	160	160	
Moment Resisting Frame Systems										
Special steel moment frames	AISC Seismic, Part I, Sec. 9	8	3	5½	NL	NL	NL	NL	NL	
Special steel truss moment frames	AISC Seismic, Part I, Sec. 12	7	3	5½	NL	NL	160	100	NP	
Intermediate steel moment frames	AISC Seismic, Part I, Sec. 10	4½	3	4	NL	NL	35 ^h	NP ^h	NP ⁱ	
Ordinary steel moment frames	AISC Seismic, Part I, Sec. 11	3½	3	3	NL	NL	NP ^h	NP ^h	NP ⁱ	
Special reinforced concrete moment frames	9.2.2.2 & ACI 318, Chapter 21	8	3	5½	NL	NL	NL	NL	NL	
Intermediate reinforced concrete moment frames	9.2.2.3 & ACI 318, Chapter 21	5	3	4½	NL	NL	NP	NP	NP	
Ordinary reinforced concrete moment frames	9.3.1 & ACI 318, Chapter 21	3	3	2½	NL	NP	NP	NP	NP	
Special composite moment frames	AISC Seismic, Part II, Sec. 9	8	3	5½	NL	NL	NL	NL	NL	
Intermediate composite moment frames	AISC Seismic, Part II, Sec. 10	5	3	4½	NL	NL	NP	NP	NP	
Composite partially restrained moment frames	AISC Seismic, Part II, Sec. 8	6	3	5½	160	160	100	NP	NP	
Ordinary composite moment frames	AISC Seismic, Part II, Sec. 11	3	3	2½	NL	NP	NP	NP	NP	

Basic Seismic-Force-Resisting System	Detailing Reference Section	R^a	Ω_{D0}^b	C_d^c	System Limitations and Height Limits (ft) by Seismic Design Category ^d				
					B	C	D ^e	E ^e	F ^f
Special masonry moment frames	11.7	5½	3	5	NL	NL	160	160	100
Dual Systems with Special Moment Frames (See Sec. 4.3.1.1.)									
Steel eccentrically braced frames	AISC Seismic, Part I, Sec. 15	8	2½	4	NL	NL	NL	NL	NL
Buckling-Restrained Braced Frame		8	2½	5	NL	NL	NL	NL	NL
Special steel concentrically braced frames	AISC Seismic, Part I, Sec. 13	7	2½	5½	NL	NL	NL	NL	NL
Special reinforced concrete shear walls	9.2.1.4	8	2½	6½	NL	NL	NL	NL	NL
Ordinary reinforced concrete shear walls	9.2.1.3	6	2½	5	NL	NL	NP	NP	NP
Composite eccentrically braced frames	AISC Seismic, Part II, Sec. 14	8	2½	4	NL	NL	NL	NL	NL
Composite concentrically braced frames	AISC Seismic, Part II, Sec. 12	6	2	5	NL	NL	NL	NL	NL
Special steel plate shear walls		8	2½	6½	NL	NL	NL	NL	NL
Composite steel plate shear walls	AISC Seismic, Part II, Sec. 17	7½	2½	6	NL	NL	NL	NL	NL
Special composite reinforced concrete shear walls with steel elements	AISC Seismic, Part II, Sec. 16	7	2½	6	NL	NL	NL	NL	NL
Ordinary composite reinforced concrete shear walls with steel elements	AISC Seismic, Part II, Sec. 15	6	2½	5	NL	NL	NP	NP	NP
Special reinforced masonry shear walls	11.5.6.3	5½	3	5	NL	NL	NL	NL	NL
Intermediate reinforced masonry shear walls	11.5.6.2	4	3	3½	NL	NL	NL	NP	NP
Dual Systems with Intermediate Moment Frames (See Sec. 4.3.1.1.)									
Special steel concentrically braced frames ^j	AISC Seismic, Part I, Sec. 13	6	2½	5	NL	NL	35 ^h	NP ^{h,i}	NP ^{h,i}

Basic Seismic-Force-Resisting System	Detailing Reference Section	R ^a	Ω_b ^b	C _d ^c	System Limitations and Height Limits (ft) by Seismic Design Category ^d				
					B	C	D ^e	E ^e	F ^f
Special reinforced concrete shear walls	9.2.1.4	6½	2½	5	NL	NL	160	100	100
Ordinary reinforced concrete shear walls	9.2.1.3	5½	2½	4½	NL	NL	NP	NP	NP
Ordinary reinforced masonry shear walls	11.5.6.1	3	3	2½	NL	160	NP	NP	NP
Intermediate reinforced masonry shear walls	11.5.6.2	3½	3	3	NL	NL	160	NP	NP
Composite concentrically braced frames	AISC Seismic, Part II, Sec. 12	5½	2½	4½	NL	NL	160	100	NP
Ordinary composite braced frames	AISC Seismic, Part II, Sec. 13	3½	2½	3	NL	NL	NP	NP	NP
Ordinary composite reinforced concrete shear walls with steel elements	AISC Seismic, Part II, Sec. 15	5½	2½	4½	NL	NL	NP	NP	NP
Inverted Pendulum Systems and Cantilevered Column Systems									
Special steel moment frames	AISC Seismic, Part I, Sec. 9	2½	2	2½	NL	NL	NL	NL	NL
Ordinary steel moment frames	AISC Seismic, Part I, Sec. 11	1¼	2	1¼	NL	NL	NP	NP	NP
Special reinforced concrete moment frames	ACI 318, Chapter 21	2½	2	2½	NL	NL	NL	NL	NL
Steel Systems Not Specifically Detailed for Seismic Resistance	AISC ASD, AISC LRFD, AISI	3	3	3	NL	NL	NP	NP	NP

^a Response modification coefficient, R, for use throughout these Provisions.
^b The tabulated value of Ω_b may be reduced by subtracting ½ for structures with flexible diaphragms, but shall not be taken as less than 2.0 for any structure.
^c Deflection amplification factor, C_d, for use throughout these Provisions.
^d NL = not limited and NP = not permitted. If using metric units, 100 ft approximately equals 30 m and 160 ft approximately equals 50 m.
^e See Sec. 4.3.1.4.1 for a description of building systems limited to buildings with a height of 240 ft (70 m) or less.
^f See Sec. 4.3.1.6 for building systems limited to buildings with a height of 160 ft (50 m) or less.
^g Steel ordinary braced frames are permitted in single story buildings up to a height of 65 ft when the dead load of the roof does not exceed 20 psf and in penthouse structures.
^h See limitations in Section Nos. 4.3.1.4.4, 4.3.1.4.5, and 4.3.1.5.2.
ⁱ See limitations in Section Nos. 4.3.1.6.1 and 4.3.1.6.2.
^j Ordinary moment frame is permitted to be used in lieu of intermediate moment frame in Seismic Design Categories B and C.
^k For intermediate precast shear wall buildings the dead load of the roof system shall not exceed 20 psf.

4.3.1.1 Dual system. For a dual system, the moment frame shall be capable of resisting at least 25 percent of the design forces. The total seismic force resistance is to be provided by the combination of the moment frame and the shear walls or braced frames in proportion to their rigidities.

4.3.1.2 Combinations of framing systems. Different seismic-force-resisting systems are permitted along the two orthogonal axes of the structure. Combinations of seismic-force-resisting systems shall comply with the requirements of this section.

4.3.1.2.1 R and Ω_0 factors. In any given direction, the value of R at any story shall not exceed the lowest value of R in the same direction above that story excluding penthouses. For other than dual systems, where a combination of different structural systems is utilized to resist lateral forces in the same direction, the value of R used in that direction shall not be greater than the least value of any of the systems utilized in the same direction. If a system, other than a dual system, with a value of R less than 5 is used as part of the seismic-force-resisting system in any direction of the structure, the lowest such value shall be used for the entire structure. The system overstrength factor, Ω_0 , in the direction under consideration at any story shall not be less than the largest value of this factor for the seismic-force-resisting system in the same direction considered above that story.

Exceptions: The requirements of this section need not be applied where one of the following conditions is satisfied:

1. Supported structural systems with a weight equal to or less than 10 percent of the weight of the structure.
2. Detached one- and two-family dwellings of light-frame construction.

4.3.1.2.2 Detailing of common components. The detailing requirements for the higher response modification coefficient, R , shall be used for structural components common to systems having different response modification coefficients.

4.3.1.3 Seismic Design Categories B and C. The structural framing system for structures assigned to Seismic Design Category B or C shall comply with the system limitations and building height limits in Table 4.3-1.

4.3.1.4 Seismic Design Category D. The structural framing system for structures assigned to Seismic Design Category D shall comply with Sec. 4.3.1.3 and the additional requirements of this section.

4.3.1.4.1 Building height limits. The height limits in Table 4.3-1 are permitted to be increased to 240 ft (70 m) in buildings that have steel braced frames or concrete cast-in-place shear walls if such buildings are configured such that the braced frames or shear walls arranged in any one plane conform to the following:

1. The braced frames or cast-in-place special reinforced concrete shear walls in any one plane shall resist no more than 60 percent of the total seismic forces in each direction, neglecting torsional effects, and
2. The seismic force in any braced frame or shear wall resulting from torsional effects shall not exceed 20 percent of the total seismic force in that braced frame or shear wall.

4.3.1.4.2 Interaction effects. Moment resisting frames that are enclosed or adjoined by more rigid elements not considered to be part of the seismic-force-resisting system shall be designed so that the action or failure of those elements will not impair the vertical load and seismic force resisting capability of the frame. The design shall consider and provide for the effect of these rigid elements on the structural system at structure deformations corresponding to the design story drift, Δ , as determined in Sec. 5.2.6.1. In addition, the effects of these elements shall be considered where determining whether a structure has one or more of the irregularities defined in Sec. 4.3.2.

4.3.1.4.3 Special moment frames. A special moment frame that is used but not required by Table 4.3-1 is permitted to be discontinued and supported by a more rigid system with a lower response

modification coefficient, R , provided the requirements of Sec. 4.6.1.6 and 4.6.3.2 are met. Where a special moment frame is required by Table 4.3-1 as part of a dual system, the frame shall be continuous to the foundation.

For structures with seismic-force-resisting systems in any direction comprised solely of special moment frames, the seismic-force-resisting system shall be configured such that the value of ρ is 1.0

4.3.1.4.4 Single Story Steel Ordinary and Intermediate Moment Frame Limitations.

Single story steel OMF and IMF are permitted up to a height of 65ft. (19.8 m) where the dead load supported by and tributary to the roof does not exceed 20 psf. In addition the dead loads, tributary to the moment frame, of the exterior wall more than 35 ft. (10.8 m) above the base shall not exceed 20 psf.

4.3.1.4.5 Other Steel Ordinary and Intermediate Moment Frame Limitations. Steel OMF not meeting the limitations in Sec. 4.3.1.4.4 are permitted within light frame construction up to a height of 35 ft. (10.8m) where neither the roof nor the floor dead load supported by and tributary to the moment frames exceeds 35 psf. In addition the dead load of the exterior walls tributary to the moment frame shall not exceed 20 psf.

Steel IMF not meeting the limitations in Sec. 4.3.1.4.4 are permitted to a height of 35ft. (10.8m)

4.3.1.5 Seismic Design Category E. The structural framing system for a structure assigned to Seismic Design Category E shall comply with Sec. 4.3.1.4 and the additional requirements of this section.

4.3.1.5.1 Plan or vertical irregularities. Structures having plan irregularity Type 1b of Table 4.3-2 or vertical irregularities Type 1b or 5 of Table 4.3-3 shall not be permitted.

4.3.1.5.2 Steel Intermediate Moment Frame Limitations.

Steel IMF not meeting the limitations in Section 4.3.1.4.4 are permitted to a height of 35 ft. (10.8 m) providing neither the roof nor the floor dead load supported by and tributary to the moment frames exceeds 35 psf. In addition the dead load of the exterior walls tributary to the moment frame shall not exceed 20 psf.

4.3.1.6 Seismic Design Category F. The structural framing system for a structure assigned to Seismic Design Category F shall comply with Sec. 4.3.1.5 and the additional requirements of this section. The height limits given in Sec. 4.3.1.4.1 shall be reduced from 240 ft to 160 ft (70 to 50 m).

4.3.1.6.1 Single Story Steel Ordinary and Intermediate Moment Frame Limitations.

Single story steel OMF and IMF are permitted up to a height of 65' where the dead load supported by and tributary to the roof does not exceed 20 psf. In addition the dead load of the exterior walls tributary to the moment frame shall not exceed 20 psf.

4.3.1.6.2 Other Steel Intermediate Moment Frame Limitations.

Steel IMF not meeting the limitations in Sec. 4.3.1.4.4 are permitted in light frame construction to a height of 35 ft. (10.8 m) providing neither the roof nor the floor dead load supported by and tributary to the moment frames exceeds 35 psf. In addition the dead load of the exterior walls tributary to the moment frame shall not exceed 20 psf.

4.3.2 Configuration. Diaphragm behavior shall be classified as indicated in this section. Structures shall be classified as regular or irregular, based on the plan and vertical configuration, in accordance with this section.

4.3.2.1 Diaphragm flexibility. A diaphragm shall be considered flexible for determining distribution of horizontal forces when the computed maximum in-plane deflection of the diaphragm itself under lateral load is more than two times the average deflection of adjoining vertical elements of the lateral force-resisting system of the associated story under equivalent tributary lateral load. The loadings used for this calculation shall be those prescribed by Sec. 5.2.

Exception: Diaphragms constructed of untopped steel decking, wood structural panels, or similar panelized construction shall be considered flexible in structures having concrete or masonry shear walls.

4.3.2.2 Plan irregularity. Structures having one or more of the features listed in Table 4.3-2 shall be designated as having plan structural irregularity and shall comply with the requirements in the sections referenced in Table 4.3-2.

4.3.2.3 Vertical irregularity. Structures having one or more of the features listed in Table 4.3-3 shall be designated as having vertical irregularity and shall comply with the requirements in the sections referenced in Table 4.3-3.

Exceptions:

1. Structural irregularities of Types 1a, 1b, or 2 in Table 4.3-3 do not apply where no story drift ratio under design lateral load is greater than 130 percent of the story drift ratio of the next story above. Torsional effects need not be considered in the calculation of story drifts for the purpose of this determination. The story drift ratio relationship for the top 2 stories of the structure are not required to be evaluated.
2. Irregularity Types 1a, 1b, and 2 of Table 4.3-3 are not required to be considered for 1-story structures or for 2-story structures assigned to Seismic Design Category B, C, or D.

Table 4.3-2 Plan Structural Irregularities

Irregularity Type and Description		Reference Section	Seismic Design Category Application
1a	Torsional Irregularity—to be considered when diaphragms are not flexible Torsional irregularity shall be considered to exist when the maximum story drift, computed including accidental torsion, at one end of the structure transverse to an axis is more than 1.2 times the average of the story drifts at the two ends of the structure.	4.4.1	D, E, and F
		4.6.3.2	D, E, and F
		5.2.4.3 and 5.2.6.1	C, D, E, and F
1b	Extreme Torsional Irregularity—to be considered when diaphragms are not flexible Extreme torsional irregularity shall be considered to exist when the maximum story drift, computed including accidental torsion, at one end of the structure transverse to an axis is more than 1.4 times the average of the story drifts at the two ends of the structure.	4.3.1.5.1	E and F
		4.4.1	D
		4.6.3.2	D
2	Re-entrant Corners Plan configurations of a structure and its lateral force-resisting system contain re-entrant corners, where both projections of the structure beyond a re-entrant corner are greater than 15 percent of the plan dimension of the structure in the given direction.	5.2.4.3 and 5.2.6.1	C, D, E, and F
		4.6.3.2	D, E, and F
3	Diaphragm Discontinuity Diaphragms with abrupt discontinuities or variations in stiffness, including those having cutout or open areas greater than 50 percent of the gross enclosed diaphragm area, or changes in effective diaphragm stiffness of more than 50 percent from one story to the next.	4.6.3.2	D, E, and F
4	Out-of-Plane Offsets Discontinuities in a lateral force resistance path, such as out-of-plane offsets of the vertical elements.	4.6.1.7	B, C, D, E, and F
		4.6.3.2	D, E, and F
5	Nonparallel Systems The vertical lateral force-resisting elements are not parallel to or symmetric about the major orthogonal axes of the seismic-force-resisting system.	4.4.2.2	C, D, E, and F

Table 4.3-3 Vertical Structural Irregularities

Irregularity Type and Description		Reference Section	Seismic Design Category Application
1a	Stiffness Irregularity—Soft Story A soft story is one in which the lateral stiffness is less than 70 percent of that in the story above or less than 80 percent of the average stiffness of the three stories above.	4.4.1	D, E, and F
1b	Stiffness Irregularity—Extreme Soft Story An extreme soft story is one in which the lateral stiffness is less than 60 percent of that in the story above or less than 70 percent of the average stiffness of the three stories above.	4.3.1.5.1 4.4.1	E and F D
2	Weight (Mass) Irregularity Mass irregularity shall be considered to exist where the effective mass of any story is more than 150 percent of the effective mass of an adjacent story. A roof that is lighter than the floor below need not be considered.	4.4.1	D, E, and F
3	Vertical Geometric Irregularity Vertical geometric irregularity shall be considered to exist where the horizontal dimension of the lateral force-resisting system in any story is more than 130 percent of that in an adjacent story.	4.4.1	D, E, and F
4	In-Plane Discontinuity in Vertical Lateral Force Resisting Elements An in-plane offset of the lateral force-resisting elements greater than the length of those elements or a reduction in stiffness of the resisting element in the story below.	4.6.1.7 4.6.3.2	B, C, D, E, and F D, E, and F
5	Discontinuity in Capacity—Weak Story A weak story is one in which the story lateral strength is less than 80 percent of that in the story above. The story strength is the total strength of all seismic-resisting elements sharing the story shear for the direction under consideration.	4.3.1.5.1 4.6.1.6	E and F B, C, and D

4.3.3 Redundancy. A redundancy factor, ρ , shall be assigned to the seismic force-resisting system in each of two orthogonal directions for all structures in accordance with this section, based on the extent of structural redundancy inherent in the seismic-force-resisting system.

4.3.3.1 Seismic Design Categories B, and C. For structures assigned to Seismic Design Category B or C, the value of ρ may be taken as 1.0.

4.3.3.2 Seismic Design Categories D, E, and F. For structures assigned to Seismic Design Category D, E, or F, ρ shall be permitted to be taken as 1.0, provided that at each story resisting more than 35 percent of the base shear in the direction of interest the seismic-force-resisting system meets the following redundancy requirements:

1. Systems with braced frames: Removal of an individual brace, or connection thereto, would not result in more than a 33 percent reduction in story strength, nor create an extreme torsional irregularity (plan structural irregularity Type 1b).
2. Systems with moment frames: Loss of moment resistance at the beam-to-column connections at both ends of a single beam would not result in more than a 33 percent reduction in story strength, nor create an extreme torsional irregularity (plan structural irregularity Type 1b).
3. Systems with shear walls or wall piers: Removal of a shear wall or wall pier with a height-to-length-ratio greater than 1.0 within any story, or collector connections thereto, would not result in more than a 33 percent reduction in story strength, nor create an extreme torsional irregularity (plan structural irregularity Type 1b).
4. All other systems: No requirements.

For structures not meeting items 1,2,3, and 4 above permitting ρ equal to 1.0, ρ shall be taken as 1.3.

Exception: The structure shall be permitted to be designed using a ρ taken as 1.0, provided that at each story that resists more than 35 percent of the base shear the seismic force-resisting system is regular in plan with at least two bays of primary seismic force-resisting elements located at the perimeter framing on each side of the structure in each orthogonal direction. The number of bays for a shear wall shall be calculated as the length of wall divided by the story height.

4.4 STRUCTURAL ANALYSIS

A structural analysis in accordance with the requirements of this section shall be made for all structures. All members of the structure's seismic-force-resisting system and their connections shall have adequate strength to resist the forces, Q_E , predicted by the analysis, in combination with other loads as required by Sec. 4.2.2.

4.4.1 Procedure selection. The structural analysis required by Sec. 4.4 shall consist of one of the types permitted in Table 4.4-1, based on the assigned Seismic Design Category and the structural characteristics (seismic-force-resisting system, fundamental period of vibration, and configuration). With the approval of the authority having jurisdiction, use of an alternative, generally accepted procedure shall be permitted.

Table 4.4-1 Analysis Procedures

Seismic Design Category	Structural Characteristics	Equivalent Lateral Force Procedure, Sec. 5.2	Response Spectrum Procedure, Sec. 5.3	Linear Response History Procedure, Sec. 5.4	Nonlinear Response History Procedure, Sec. 5.5
B, C	Regular or irregular	P	P	P	P
D, E, F	All structures of light-frame construction; and structures with $T < 3.5T_s$ that are regular or have only plan irregularities Type 2, 3, 4, or 5 of Table 4.3-2 or vertical irregularities Type 4 or 5 of Table 4.3-3	P	P	P	P
	All other structures	NP	P	P	P
P indicates permitted; NP indicates not permitted.					

4.4.2 Application of loading. The directions of application of seismic forces used in the design shall be those that will produce the most critical load effects. The procedures indicated in this section for various Seismic Design Categories shall be deemed to satisfy this requirement.

4.4.2.1 Seismic Design Category B. For structures assigned to Seismic Design Category B, the design seismic forces are permitted to be applied separately in each of two orthogonal directions and orthogonal interaction effects may be neglected.

4.4.2.2 Seismic Design Category C. Loading applied to structures assigned to Seismic Design Category C shall, as a minimum, conform to the requirements of Sec. 4.4.2.1 and the requirements of this section. Structures that have plan irregularity Type 5 in Table 4.3-2 shall be analyzed for seismic forces using a three-dimensional representation and either of the following procedures:

1. The structure shall be analyzed using the equivalent lateral force procedure of Sec. 5.2, the response spectrum procedure of Sec. 5.3, or the linear response history procedure of Sec. 5.4 as permitted under Sec. 4.4.1 with the loading applied independently in any two orthogonal directions and the most critical load effect due to direction of application of seismic forces on the structure may be assumed to be satisfied if components and their foundations are designed for the following combination of prescribed loads: 100 percent of the forces for one direction plus 30 percent of the forces for the perpendicular direction; the combination requiring the maximum component strength shall be used.
2. The structure shall be analyzed using the linear response history procedure of Sec. 5.4 or the nonlinear response history procedure of Sec. 5.5 as permitted by Sec. 4.4.1 with simultaneous application of ground motion in each of two orthogonal directions.

4.4.2.3 Seismic Design Categories D, E, and F. Structures assigned to Seismic Design Category D, E, or F shall be analyzed for seismic forces using a three-dimensional representation and either of the procedures described in Sec. 4.4.2.2. Two dimensional analysis shall be permitted where diaphragms are flexible and the structure does not have plan irregularity Type 5 of Table 4.3-2.

4.5 DEFORMATION REQUIREMENTS

4.5.1 Deflection and drift limits. The design story drift, Δ , as determined in Sec. 5.2.6, 5.3.5, or 5.4.3, shall not exceed the allowable story drift, Δ_a , as obtained from Table 4.5-1 for any story. For structures with significant torsional deflections, the maximum drift shall include torsional effects. All portions of the structure shall be designed and constructed to act as an integral unit in resisting seismic forces unless separated structurally by a distance sufficient to avoid damaging contact under total deflection, δ_x , as determined in Sec. 5.2.6.1.

Table 4.5-1 Allowable Story Drift, Δ_a ^{ab}

Structure	Seismic Use Group		
	I	II	III
Structures, other than those using masonry seismic-force-resisting systems, four stories or less in height with interior walls, partitions, ceilings, and exterior wall systems that have been designed to accommodate the story drifts	0.025 h_{sx} ^c	0.020 h_{sx}	0.015 h_{sx}
Masonry cantilever shear wall structures ^d	0.010 h_{sx}	0.010 h_{sx}	0.010 h_{sx}
Other masonry shear wall structures	0.007 h_{sx}	0.007 h_{sx}	0.007 h_{sx}
Special masonry moment frames	0.013 h_{sx}	0.013 h_{sx}	0.010 h_{sx}
All other structures	0.020 h_{sx}	0.015 h_{sx}	0.010 h_{sx}
^a h_{sx} is the story height below Level x . ^b For SDC D,E and F, the allowable story drift shall comply with the requirements of Sec.4.5.3. ^c There shall be no drift limit for single-story structures with interior walls, partitions, ceilings, and exterior wall systems that have been designed to accommodate the story drifts. ^d Structures in which the basic structural system consists of masonry shear walls designed as vertical elements cantilevered from their base or foundation support which are so constructed that moment transfer between shear walls (coupling) is negligible.			

4.5.2 Seismic Design Categories B and C. The deflection in the plane of the diaphragm, as determined by engineering analysis, shall not exceed the permissible deflection of the attached elements. Permissible deflection shall be a deflection that permits the attached elements to maintain their structural integrity under the individual loading and to continue to support the prescribed loads.

4.5.3 Seismic Design Categories D, E, and F. Structures assigned to Seismic Design Category D, E, or F shall comply with Sec. 4.5.2 and the additional requirements of this section. Every structural component not included as part of the seismic-force-resisting system in the direction under consideration shall be designed to be adequate for the effects of gravity loads in combination with the induced moments and shears resulting from the design story drift, Δ , as determined in accordance with Sec. 5.2.6.1.

Exception: Beams and columns and their connections not designed as part of the seismic-force-resisting system but meeting the detailing requirements for either intermediate moment frames or special moment frames are permitted to be designed to be adequate for the effects of

gravity loads in combination with the induced moments and shears resulting from the deformation of the building under the application of the design seismic forces.

Where determining the moments and shears induced in components that are not included as part of the seismic-force-resisting system in the direction under consideration, the stiffening effects of adjoining rigid structural and nonstructural elements shall be considered and a rational value of member and restraint stiffness shall be used.

For systems with moment frames the design story drift Δ , as determined in Sec. 5.2.6, 5.3.5, or 5.4.3, shall not exceed Δ_a/ρ for any story. ρ shall be calculated per Sec.4.3.3.

4.6 DESIGN AND DETAILING REQUIREMENTS

The design and detailing of the components of the seismic-force-resisting system shall comply with the requirements of this section. Foundation design shall comply with the applicable requirements of Chapter 7. The materials and the systems composed of those materials shall comply with applicable requirements and limitations found elsewhere in these *Provisions*.

4.6.1 Seismic Design Category B. The design and detailing of structures assigned to Seismic Design Category B shall comply with the requirements of this section.

4.6.1.1 Connections. All parts of the structure between separation joints shall be interconnected, and the connections shall be capable of transmitting the seismic force, F_p , induced by the parts being connected. Any smaller portion of the structure shall be tied to the remainder of the structure with elements having a strength of 0.133 times S_{DS} times the weight of the smaller portion or 5 percent of the portion's weight, whichever is greater.

A positive connection for resisting a horizontal force acting parallel to the member shall be provided for each beam, girder, or truss to its support. The connection shall have a minimum strength of 5 percent of the reaction due to dead load and live load.

4.6.1.2 Anchorage of concrete or masonry walls. Concrete or masonry walls shall be connected, using reinforcement or anchors, to the roof and all floors and members that provide lateral support for the wall or that are supported by the wall. The connection shall be capable of resisting a seismic lateral force induced by the wall of 100 pounds per lineal foot (1500 N/m). Walls shall be designed to resist bending between connections where the spacing exceeds 4 ft (1.2 m).

4.6.1.3 Bearing walls. Exterior and interior bearing walls and their anchorage shall be designed for a force equal to 40 percent of S_{DS} times the weight of wall, W_c , normal to the surface, with a minimum force of 10 percent of the weight of the wall. Interconnection of wall elements and connections to supporting framing systems shall have sufficient ductility, rotational capacity, or strength to resist shrinkage, thermal changes, and differential foundation settlement where combined with seismic forces.

4.6.1.4 Openings. Where openings occur in shear walls, diaphragms or other plate-type elements, reinforcement at the edges of the openings shall be designed to transfer the stresses into the structure. The edge reinforcement shall extend into the body of the wall or diaphragm a distance sufficient to develop the force in the reinforcement.

4.6.1.5 Inverted pendulum-type structures. Supporting columns or piers of inverted pendulum-type structures shall be designed for the bending moment calculated at the base determined using the procedures given in Sec. 5.2 and varying uniformly to a moment at the top equal to one-half the calculated bending moment at the base.

4.6.1.6 Discontinuities in vertical system. Structures with vertical irregularity Type 5 as defined in Table 4.3-3, shall not be over the lesser of 2 stories or 30 ft (9 m) in height where the weak story has a calculated strength of less than 65 percent of the strength of the story above.

Exception: The height limit shall not apply where the weak story is capable of resisting a total seismic force equal to 75 percent of the deflection amplification factor, C_d , times the design force prescribed in Sec. 5.2.

4.6.1.7 Columns supporting discontinuous walls or frames. Columns supporting discontinuous walls or frames of structures having plan irregularity Type 4 of Table 4.3-2 or vertical irregularity Type 4 of Table 4.3-3 shall have the design strength to resist the maximum axial force that can develop in accordance with Sec. 4.2.2.2.

4.6.1.8 Collector elements. Collector elements shall be provided and shall be capable of transferring the seismic forces originating in other portions of the structure to the element providing the resistance to those forces.

4.6.1.9 Diaphragms. Floor and roof diaphragms shall be designed to resist the following seismic forces: A minimum force equal to 20 percent of S_{DS} times the weight of the diaphragm and other elements of the structure attached thereto plus the portion of the seismic shear force at that level, V_x , required to be transferred to the components of the vertical seismic-force-resisting system because of offsets or changes in stiffness of the vertical components above and below the diaphragm.

Diaphragms shall provide for both the shear and bending stresses resulting from these forces. Diaphragms shall have ties or struts to distribute the wall anchorage forces into the diaphragm. Diaphragm connections shall be positive, mechanical or welded type connections.

4.6.1.10 Anchorage of nonstructural systems. Where required by Chapter 6, all portions or components of the structure shall be anchored for the seismic force, F_p , prescribed therein.

4.6.2 Seismic Design Category C. Structures assigned to Seismic Design Category C shall comply with the requirements of Sec. 4.6.1 and the requirements of this section.

4.6.2.1 Anchorage of concrete or masonry walls. In addition to the requirements of Sec. 4.6.1.2, concrete or masonry walls shall be anchored in accordance with this section. The anchorage shall provide a positive direct connection between the wall and floor, roof, or supporting member capable of resisting horizontal forces specified in this section for structures with flexible diaphragms or of Sec. 6.2.2 (using a_p equal to 1.0 and R_p equal to 2.5) for structures with diaphragms that are not flexible.

Anchorage of walls to flexible diaphragms shall have the strength to develop the out-of-plane force given by Eq. 4.6-1 as follows:

$$F_p = 0.8S_{DS}IW_p \quad (4.6-1)$$

where:

- F_p = the design force in the individual anchors,
- S_{DS} = the design spectral response acceleration parameter at short periods as defined in Sec. 3.3.3,
- I = the occupancy importance factor as defined in Sec. 1.3, and
- W_p = the weight of the wall tributary to the anchor.

Diaphragms shall be provided with continuous ties or struts between diaphragm chords to distribute these anchorage forces into the diaphragms. Added chords are permitted to be used to form subdiaphragms to transmit the anchorage forces to the main continuous cross ties. The maximum length-to-width ratio of the structural subdiaphragm shall be 2.5 to 1. Connections and anchorages capable of resisting the prescribed forces shall be provided between the diaphragm and the attached components. Connections shall extend into the diaphragm a sufficient distance to develop the force transferred into the diaphragm.

In wood diaphragms, the continuous ties shall be in addition to the diaphragm sheathing. Anchorage shall not be accomplished by use of toe nails or nails subject to withdrawal nor shall wood ledgers of framing be used in cross-grain bending or cross-grain tension. The diaphragm sheathing shall not be considered as effectively providing the ties or struts required by this section.

In metal deck diaphragms, the metal deck shall not be used as the continuous ties required by this section in the direction perpendicular to the deck span.

Diaphragm to wall anchorage using embedded straps shall be attached to or hooked around the reinforcing steel or otherwise terminated so as to effectively transfer forces to the reinforcing steel.

4.6.2.2 Collector elements. In addition to the requirements of Sec. 4.6.1.8, collector elements, splices, and their connections to resisting elements shall be designed to resist the forces defined in Sec. 4.2.2.2.

Exception: In structures or portions thereof braced entirely by light-frame shear walls, collector elements, splices, and connections to resisting elements are permitted to be designed to resist the forces determined in accordance with Sec. 4.6.3.4.

4.6.3 Seismic Design Categories D, E, and F. Structures assigned to Seismic Design Category D, E, or F shall conform to the requirements of Sec. 4.6.2 and to the requirements of this section.

4.6.3.1 Vertical seismic forces. The vertical component of earthquake ground motion shall be considered in the design of horizontal cantilever and horizontal prestressed components. The load combinations used in evaluating such components shall include E as defined by Eq. 4.2-1 and 4.2-2. Horizontal cantilever structural components shall be designed for a minimum net upward force of 0.2 times the dead load in addition to the applicable load combinations of Sec. 4.2.2.

4.6.3.2 Plan or vertical irregularities. The design shall consider the potential for adverse effects where the ratio of the strength provided in any story to the strength required is significantly less than that ratio for the story immediately above and the strengths shall be adjusted to compensate for this effect.

For structures having a plan structural irregularity of Type 1a, 1b, 2, 3, or 4 in Table 4.3-2 or a vertical structural irregularity of Type 4 in Table 4.3-3, the design forces determined from the structural analysis performed in accordance with Sec. 4.4 shall be increased 25 percent for connections of diaphragms to vertical elements and to collectors. Collector forces determined in accordance with Sec. 4.6.3.4 (but not those determined in accordance with Sec. 4.2.2.2) shall be subject to this increase.

4.6.3.3 Collector elements. In addition to the requirements of Sec. 4.6.2.2, collector elements, splices, and their connections to resisting elements shall resist the forces determined in accordance with Sec. 4.6.3.4.

4.6.3.4 Diaphragms. Diaphragms shall be designed to resist design seismic forces determined in accordance with Eq. 4.6-2 as follows:

$$F_{px} = \frac{\sum_{i=x}^n F_i}{\sum_{i=x}^n w_i} w_{px} \quad (4.6-2)$$

where:

- F_{px} = the diaphragm design force at Level x ,
- F_i = the design force applied to Level i ,
- w_i = the weight tributary to Level i , and
- w_{px} = the weight tributary to the diaphragm at Level x .

The force determined from Eq. 4.6-2 need not exceed $0.4S_{DS}Iw_{px}$ but shall not be less than $0.2S_{DS}Iw_{px}$. Where the diaphragm is required to transfer design seismic force from the vertical-resisting elements above the diaphragm to other vertical-resisting elements below the diaphragm due to offsets in the placement of the elements or to changes in relative lateral stiffness in the vertical elements, these forces shall be added to those determined from Eq. 4.6-2.

ALTERNATIVE SIMPLIFIED CHAPTER 4:

ALTERNATIVE STRUCTURAL DESIGN CRITERIA FOR SIMPLE BEARING WALL OR BUILDING FRAME SYSTEMS

Alt.4.1 GENERAL

Alt. 4.1.1 Simplified design procedure. Simple bearing wall and building frame systems and their components meeting the qualifications of this section shall be permitted to be designed as prescribed in this chapter as an alternative to the Provisions of Chapter 4, and 5. This chapter also provides alternative procedures for determining site class and site coefficients. The Seismic Design Category shall be determined from Table 1.4-1 using the value of S_{DS} from Section Alt. 4.6.1. Application of this Alternative Simplified Chapter is subject to all of the following limitations:

1. Structure shall qualify for Seismic Use Group I.
2. The Site Class, defined in Sec. 3.5, shall not be Class E or F.
3. Structure shall not exceed three stories in height above grade.
4. Seismic-force resisting system shall be either a Bearing Wall System or Building Frame System, as indicated in Alt. Table 4.3.1
5. The structure shall have at least two lines of lateral resistance in each of two major axis directions.
6. At least one line of resistance shall be provided on each side of the center of mass in each direction.
7. The sum of the strengths of the lines of resistance on each side of the center of mass shall equal at least 40 percent of the story shear.
8. For buildings with a diaphragm that is not flexible, the distance between the center of rigidity and the center of mass parallel to each major axis shall not exceed 15 percent of the greatest width of the diaphragm parallel to that axis.
9. Lines of resistance of the lateral-force-resisting system shall be oriented at angles of no more than 15 degrees from alignment with the major orthogonal horizontal axes of the building.
10. The alternative simplified design procedure shall be used for each major orthogonal horizontal axis direction of the building.
11. System irregularities caused by in-plane or out-of-plane offsets of lateral force-resisting elements shall not be permitted.
12. The lateral-load-resistance of any story shall not be less than 80 percent of the story above.

Alt. 4.1.2 References. The reference documents listed in Sec 4.1.2 shall be used as indicated in this Simplified Alternate Chapter 4.

Alt. 4.1.3 Definitions. The definitions listed in Sec. 4.1.3 shall be used for this Alternative Simplified Chapter 4 in addition to the following:

Major orthogonal horizontal directions: The orthogonal directions that overlay the majority of lateral force resisting elements.

Alt. 4.1.4 Notation

D	The effect of dead load.
E	The effect of horizontal and vertical earthquake-induced forces.
F_i	The portion of the seismic base shear, V , induced at Level i .
F_p	The seismic design force applicable to a particular structural component.
F_x	See Sec. 1.1.5.
h_i	The height above the base to Level i .
h_x	The height above the base to Level x .
I	See Sec. 1.1.5.
Level i	The building level referred to by the subscript i ; $i = 1$ designates the first level above the base.
Level n	The level that is uppermost in the main portion of the of the building.
Level x	See Sec. 1.1.5.
Q_E	The effect of horizontal seismic forces.
R	The response modification coefficient as given in Table 4.3-1.
S_{DS}	See Sec. 3.1.4.
S_S	See Sec 3.3.1.
V	The total design shear at the base of the structure in the direction of interest, as determined using the procedure of A4.6.1
V_x	The seismic design shear in Story x . See Sec. A4.6.3.
W	See Sec. 1.1.5.
W_c	Weight of wall.
W_p	Weight of structural component.
w_i	The portion of the seismic weight, W , located at or assigned to Level i .
w_x	See Sec. 1.1.5.

Alt. 4.2 DESIGN BASIS

Alt. 4.2.1 General. The structure shall include complete lateral and vertical-force-resisting systems capable of providing adequate strength, stiffness, and energy dissipation capacity to withstand the design ground motions within the prescribed limits of strength demand. The adequacy of the structural systems shall be demonstrated through construction of a mathematical model and evaluation of this model for the effects of the design ground motions. This evaluation shall consist of a linear elastic analysis in which design seismic forces are distributed and applied throughout the height of the structure in accordance with the procedures of Sec. Alt. 4.6. The corresponding internal forces in all members of the structure shall be determined and evaluated against acceptance criteria contained in these *Provisions*.

Individual members shall be provided with adequate strength to resist the shears, axial forces, and moments determined in accordance with these *Provisions*. A continuous load path, or paths, with adequate strength and stiffness shall be provided to transfer all forces from the point of application to the final point of resistance. The foundation shall be designed to accommodate the forces developed or the movements imparted to the structure by the design ground motions.

Alt. 4.2.2 Combination of Load Effects. The effects on the structure and its components due to gravity loads and seismic forces shall be combined in accordance with the factored load combinations as presented in ASCE 7-02, except that the effect of seismic loads, E , shall be as defined herein.

Alt. 4.2.2.1 Seismic load effect. The effect of seismic load E shall be defined by Eq. Alt. 4.2-1 as follows for load combinations in which the effects of gravity loads and seismic loads are additive:

$$E = Q_E + 0.2S_{DS}D \quad (\text{Alt. 4.2-1})$$

where:

E = the effect of horizontal and vertical earthquake-induced forces,

S_{DS} = the design spectral response acceleration at short periods obtained from
Sec. Alt. 4.6.1

D = the effect of dead load, and

Q_E = the effect of horizontal seismic forces.

The effect of seismic load E shall be defined by Eq. Alt. 4.2-2 as follows for load combinations in which the effects of gravity counteract seismic load:

$$E = Q_E - 0.2S_{DS}D \quad (\text{Alt.4.2-2})$$

where E , Q_E , S_{DS} , and D are as defined above.

Alt. 4.2.2.2 Seismic load effect with overstrength. Where specifically required by these *Provisions*, the design seismic force on components sensitive to the effects of structural overstrength shall be as defined by Eq. 4.2-3 and 4.2-4 for load combinations in which the effects of gravity are respectively additive with or counteractive to the effect of seismic loads:

$$E = \Omega_0 Q_E + 0.2S_{DS}D \quad (\text{Alt. 4.2-3})$$

$$E = \Omega_0 Q_E - 0.2S_{DS}D \quad (\text{Alt. 4.2-4})$$

where E , Q_E , S_{DS} , and D are as defined above. Ω_0 shall be taken as 2-1/2.

Alt. 4.3 SEISMIC-FORCE-RESISTING SYSTEM

Alt. 4.3.1 Selection and Limitations. The basic lateral and vertical seismic-force-resisting system shall conform to one of the types indicated in Alt. Table 4.3.1. Each type is subdivided by the type of vertical element used to resist lateral seismic forces. The appropriate response modification coefficient, R , indicated in Alt. Table 4.3.1 shall be used in determining the base shear and element design forces as indicated in these *Provisions*.

Special framing and detailing requirements are indicated in Sec. Alt. 4.5 and in Chapters 8, 9, 10, 11, and 12 for structures assigned to the various Seismic Design Categories.

Alt. Table 4.3-1 Design Coefficients and Factors for Basic Seismic-Force-Resisting Systems

Basic Seismic-Force-Resisting System	Detailing Reference Section	R^a	System Limitations by Seismic Design Category ^b		
			B	C	D,E
Bearing Wall Systems					
Special reinforced concrete shear walls	9.2.1.6	5	P	P	P
Ordinary reinforced concrete shear walls	9.2.1.4	4	P	P	NP
Detailed plain concrete shear walls	9.2.1.2	2	P	NP	NP
Ordinary plain concrete shear walls	9.2.1.1	1½	P	NP	NP
Intermediate precast shear walls	9.2.1.5	4	P	P	P
Ordinary precast shear walls	9.2.1.3	3	P	NP	NP
Special reinforced masonry shear walls	11.5.6.3	3½	P	P	P
Intermediate reinforced masonry shear walls	11.5.6.2	2½	P	P	NP
Ordinary reinforced masonry shear walls	11.5.6.1	2	P	NP	NP
Detailed plain masonry shear walls	11.4.4.2	2	P	NP	NP
Ordinary plain masonry shear walls	11.4.4.1	1½	P	NP	NP
Prestressed masonry shear walls	11.9	1½	P	NP	NP
Light-frame walls with shear panels	8.4, 12.3.3, 12.4	6½	P	P	P
Light-frame walls with diagonal braces	8.4.2	4	P	P	P
Building Frame Systems					
Special steel concentrically braced frames	AISC Seismic, Part I, Sec. 13	6	P	P	P
Ordinary steel concentrically braced frames	AISC Seismic, Part I, Sec. 14	5	P	P	P
Special reinforced concrete shear walls	9.2.1.6	6	P	P	P

Alternative Structural Design Criteria for Simple Bearing Wall or Building Frame Systems

Ordinary reinforced concrete shear walls	9.2.1.4	5	P	P	NP
Detailed plain concrete shear walls	9.2.1.2	2½	P	NP	NP
Ordinary plain concrete shear walls	9.2.1.1	1½	P	NP	NP
Intermediate precast shear walls	9.2.1.5	5	P	P	P
Ordinary precast shear walls	9.2.1.3	4	P	NP	NP
Composite concentrically braced frames	AISC Seismic, Part II, Sec. 12	5	P	P	P
Ordinary composite braced frames	AISC Seismic, Part II, Sec. 13	3	P	P	NP
Composite steel plate shear walls	AISC Seismic, Part II, Sec. 17	6½	P	P	P
Special steel plate shear walls		7	P	P	P
Special composite reinforced concrete shear walls with steel elements	AISC Seismic, Part II, Sec. 16	6	P	P	P
Ordinary composite reinforced concrete shear walls with steel elements	AISC Seismic, Part II, Sec. 15	5	P	P	NP
Special reinforced masonry shear walls	11.5.6.3	4½	P	P	P
Intermediate reinforced masonry shear walls	11.5.6.2	3	P	P	NP
Ordinary reinforced masonry shear walls	11.5.6.1	2	P	NP	NP
Detailed plain masonry shear walls	11.4.4.2	2	P	NP	Np
Ordinary plain masonry shear walls	11.4.4.1	1½	P	NP	NP
Prestressed masonry shear walls	11.9	1½	P	NP	NP
Light-frame walls with shear panels	8.4, 12.3.3, 12.4	7	P	P	P
Steel Systems Not Specifically Detailed for Seismic Resistance (Concentric Braced Frame systems only)	AISC ASD, AISC LRFD, AISI	3	P	P	NP
^a Response modification coefficient, <i>R</i> , for use throughout these <i>Provisions</i> .					
^b P = Permitted and NP = Not Permitted.					

Alt. 4.3.1.1 Combinations of Framing Systems. A combination of different structural systems shall not be utilized to resist lateral forces in the same direction. Seismic-force-resisting systems are permitted to

differ between the two major horizontal axes of the structure, provided that systems shall not be vertically combined from story to story.

Exception: Penthouses and other rooftop-supported structures weighing less than 25% of the roof level need not be considered a story. The limitations of Sec 4.1.1 do not apply to these structures. The value of R used for combinations of different systems shall not be greater than the least value of any of the systems utilized in the same direction. The systems utilized may differ from those of the supporting structure below.

Alt. 4.3.1.1.2 Combination Framing Detailing Requirements. The detailing requirements of Sec. Alt. 4.5 required by the higher response modification coefficient, R , shall be used for structural components common to systems having different response modification coefficients.

Alt. 4.3.2 Diaphragm Flexibility. Diaphragms constructed of untopped steel decking, wood structural panels or similar panelized construction may be considered flexible.

Alt. 4.4 APPLICATION OF LOADING The effects of the combination of loads shall be considered as prescribed in Sec. Alt. 4.2.2. The design seismic forces are permitted to be applied separately in each orthogonal direction and the combination of effects from the two directions need not be considered. Reversal of load shall be considered.

Alt. 4.5 DESIGN AND DETAILING REQUIREMENTS The design and detailing of the components of the seismic-force-resisting system shall comply with the requirements of this section. Foundation design shall conform to the applicable requirements of Chapter 7. The materials and the systems composed of those materials shall conform to the applicable requirements and limitations found elsewhere in these Provisions.

Alt. 4.5.1 Connections. All parts of the structure between separation joints shall be inter-connected, and the connection shall be capable of transmitting the seismic force, F_p , induced by the parts being connected. Any smaller portion of the structure shall be tied to the remainder of the structure with elements having a strength of 0.20 times the short period design spectral response acceleration coefficient, S_{DS} , times the weight of the smaller portion or 5 percent of the portion's weight, whichever is greater.

A positive connection for resisting a horizontal force acting parallel to the member shall be provided for each beam, girder, or truss to its support. The connections shall have a minimum strength of 5 percent of the dead load and live load reaction.

Alt. 4.5.2 Openings or Re-entrant Building Corners. Except where as otherwise specifically provided for in these provisions, openings in shear walls, diaphragms or other plate-type elements, shall be provided with reinforcement at the edges of the openings designed to transfer the stresses into the structure. The edge reinforcement shall extend into the body of the wall or diaphragm a distance sufficient to develop the force in the reinforcement.

Alt. 4.5.3 Collector Elements. Collector elements shall be provided with adequate strength to transfer the seismic forces originating in other portions of the structure to the element providing the resistance to those forces. Collector elements, splices, and their connections to resisting elements shall be designed to resist the forces defined in Sec. Alt. 4.2.2.2.

Exception: In structures or portions thereof braced entirely by light-frame shear walls, collector elements, splices, and connections to resisting elements are permitted to be designed to resist forces in accordance with Sec. Alt. 4.5.4.

Alt. 4.5.4 Diaphragms. Floor and roof diaphragms shall be designed to resist the design seismic forces at each level, F_x , calculated in accordance with Sec. Alt. 4.6.2. When the diaphragm is required to transfer design seismic forces from the vertical-resisting elements above the diaphragm to other vertical-

resisting elements below the diaphragm due to changes in relative lateral stiffness in the vertical elements, the transferred portion of the seismic shear force at that level, V_x , shall be added to the diaphragm design force. Diaphragms shall provide for both the shear and bending stresses resulting from these forces. Diaphragms shall have ties or struts to distribute the wall anchorage forces into the diaphragm. Diaphragm connections shall be positive, mechanical or welded type connections.

Alt. 4.5.5 Anchorage of Concrete or Masonry Walls

Alt. 4.5.5.1 Seismic Design Category B. Concrete or masonry walls shall be connected, using reinforcement or anchors, to the roof and all floors and members that provide lateral support for the wall or that are supported by the wall. The connection shall be capable of resisting a seismic lateral force induced by the wall of 100 pounds per lineal foot (1500 K/m). Walls shall be designed to resist bending between connections where the spacing exceeds 4 ft (1.2 m).

Alt. 4.5.5.2 Seismic Design Category C and D. In addition to the requirements of Sec. Alt 4.5.5.1, concrete or masonry walls shall be anchored in accordance with this section.. The anchorage shall provide a positive direct connection between the wall and floor, roof, or supporting member capable of resisting horizontal forces specified in this section for structures with flexible diaphragms or of Sec. 6.2.2 (using a_p equal to 1.0 and R_p equal to 2.5) for structures with diaphragms that are not flexible.

Anchorage of walls to flexible diaphragms shall have the strength to develop the out-of-plane force given by Eq. A4.5-1:

$$F_p = 0.8 S_{DS} W_p \quad (\text{Alt. 4.5-1})$$

where:

F_p = the design force in the individual anchors,

S_{DS} = the design spectral response acceleration at short periods per Sec. Alt. 4.6.1, and

W_p = the weight of the wall tributary to the anchor

Diaphragms shall be provided with continuous ties or struts between diaphragm chords to distribute these anchorage forces into the diaphragms. Added chords are permitted to be used to form subdiaphragms to transmit the anchorage forces to the main continuous cross ties. The maximum length to width ratio of the structural subdiaphragm shall be 2-1/2 to 1. Connections and anchorages capable of resisting the prescribed forces shall be provided between the diaphragm and the attached components. Connections shall extend into the diaphragm a sufficient distance to develop the force transferred into the diaphragm.

In wood diaphragms, the continuous ties shall be in addition to the diaphragm sheathing. Anchorage shall not be accomplished by use of toe nails or nails subject to withdrawal nor shall wood ledgers of framing be used in cross-grain bending or cross-grain tension. The diaphragm sheathing shall not be considered effective as providing the ties or struts required by this section.

In metal deck diaphragms, the metal deck shall not be used as the continuous ties required by this section in the direction perpendicular to the deck span.

Diaphragm to wall anchorage using embedded straps shall be attached to or hooked around the reinforcing steel or otherwise terminated so as to effectively transfer forces to the reinforcing steel.

Alt. 4.5.6 Bearing Walls. Exterior and interior bearing walls and their anchorage shall be designed for a force equal to 40 percent of the short period design spectral response acceleration S_{DS} times the weight of wall, W_c , normal to the surface, with a minimum force of 10 percent of the weight of the wall.

Interconnection of wall elements and connections to supporting framing systems shall have sufficient ductility, rotational capacity, or sufficient strength to resist shrinkage, thermal changes, and differential foundation settlement when combined with seismic forces.

Alt. 4.5.7 Anchorage of Nonstructural Systems. When required by Chapter 6, all portions or components of the structure shall be anchored for the seismic force, F_p , prescribed therein.

Alt. 4.6 SIMPLIFIED LATERAL FORCE ANALYSIS PROCEDURE An equivalent lateral force analysis shall consist of the application of equivalent static lateral forces to a linear mathematical model of the structure. The lateral forces applied in each direction shall sum to a total seismic base shear given by Sec. Alt. 4.6.1 and shall be distributed vertically in accordance with Sec. Alt. 4.6.2. For purposes of analysis, the structure shall be considered fixed at the base.

Alt. 4.6.1 Seismic Base Shear

The seismic base shear, V , in a given direction shall be determined in accordance with formula Alt. 4.6-1:

$$V = \frac{1.25S_{DS}}{R}W \quad (\text{Alt. 4.6-1})$$

where:

$S_{DS} = 2/3F_aS_s$, where F_a may be taken as 1.0 for rock sites, 1.4 for soil sites, or determined in accordance with Section 3.3.2. For the purpose of this section, sites may be considered to be rock if there is no more than 10 ft (3 m) of soil between the rock surface and the bottom of spread footing or mat foundation. In calculating S_{DS} , S_s need not be taken larger than 1.5.

R = the response modification factor from Table A4.3.1 and

W = the total dead load and applicable portions of other loads listed below:

1. In areas used for storage, a minimum of 25 percent of the floor live load shall be applicable. The live load may be reduced for tributary area as permitted by the structural code administered by the authority having jurisdiction. Floor live load in public garages and open parking structures is not applicable.
2. Where an allowance for partition load is included in the floor load design, the actual partition weight or a minimum weight of 10 psf (500 Pa/m²) of floor area, whichever is greater, shall be applicable.
3. Total operating weight of permanent equipment.
4. In areas where the design flat roof snow load does not exceed 30 pounds per square foot, the effective snow load is permitted to be taken as zero. In areas where the design snow load is greater than 30 pounds per square foot and where siting and load duration conditions warrant and when approved by the authority having jurisdiction, the effective snow load is permitted to be reduced to not less than 20 percent of the design snow load.

Alt. 4.6.2 Vertical distribution. The forces at each level shall be calculated using the following formula:

$$F_x = \frac{1.25S_{DS}}{R}w_x \quad (\text{Alt. 4.6-2})$$

where w_x = the portion of the effective seismic weight of the structure, W at Level x .

Alt. 4.6.3 Horizontal Shear Distribution. The seismic design story shear in any story, V_x (kip or kN), shall be determined from the following equation:

$$V_x = \sum_{i=x}^n F_i \quad (\text{Alt. 4.6-3})$$

where F_i = the portion of the seismic base shear, V (kip or kN) induced at Level i .

Alt. 4.6.3.1 Flexible Diaphragm Structures. The seismic design story shear in stories of structures with flexible diaphragms, as defined in Sec. Alt. 4.3.2, shall be distributed to the vertical elements of the lateral force resisting system using tributary area rules. Two-dimensional analysis shall be permitted where diaphragms are flexible.

Alt. 4.6.3.2 Structures with Diaphragms that are not Flexible. For structures with diaphragms that are not flexible, as defined in Sec. Alt. 4.3.2, the seismic design story shear, V_x , (kip or kN) shall be distributed to the various vertical elements of the seismic-force-resisting system in the story under consideration based on the relative lateral stiffnesses of the vertical elements and the diaphragm.

Alt. 4.6.3.2.1 Torsion. The design of structures with diaphragms that are not flexible shall include the torsional moment, M_t (kip-ft or KN-m) resulting from eccentric location of the masses.

Alt. 4.6.4 Overturning. The structure shall be designed to resist overturning effects caused by the seismic forces determined in Sec. Alt. 4.6.2. At any story, the increment of overturning moment in the story under consideration shall be distributed to the various vertical force-resisting elements in the same proportion as the distribution of the horizontal shears to those elements.

The overturning moments at Level x , M_x (kip-ft or kN-m) shall be determined from the following equation:

$$M_x = \sum_{i=x}^n F_i (h_i - h_x) \quad (\text{Alt.4.6-4})$$

where:

F_i = the portion of the seismic base shear, V , induced at Level i , and

h_i and h_x = the height (ft or m) from the base to Level i or x .

The foundations of structures shall be designed for 75% of the foundation overturning design moment, M_f (kip-ft or kN-m) at the foundation-soil interface.

Alt. 4.6.5 Drift Limits and Building Separation. Structural drift need not be calculated. When a drift value is needed for use in material standards to determine structural separations between buildings, for design of cladding, or for other design requirements, it shall be taken as 1% of building height. All portions of the structure shall be designed to act as an integral unit in resisting seismic forces unless separated structurally by a distance sufficient to avoid damaging contact under the total deflection, δ_x , as defined in Sec 5.2.6.1.

This page is intentionally left blank.

Chapter 5

STRUCTURAL ANALYSIS PROCEDURES

5.1 GENERAL

5.1.1 Scope. This chapter provides minimum requirements for the structural analysis procedures prescribed in Sec. 4.4.1. If the alternate design procedure of Alternative Simplified Chapter 4 is used, this chapter does not apply.

5.1.2 Definitions

Base: See Sec. 4.1.3.

Base shear: See Sec. 4.1.3.

Building: See Sec. 4.1.3.

Component: See Sec. 1.1.4.

Dead load: See Sec. 4.1.3.

Design earthquake ground motion: See Sec. 1.1.4.

Design strength: See Sec. 4.1.3.

Diaphragm: See Sec. 4.1.3.

Eccentrically braced frame (EBF): See Sec. 4.1.3.

Inverted pendulum-type structures: See Sec. 4.1.3.

Live load: See Sec. 4.1.3.

Maximum considered earthquake ground motion: See Sec. 3.1.3.

Moment frame: See Sec. 4.1.3.

Nominal strength: See Sec. 4.1.3.

Occupancy importance factor: See Sec. 1.1.4.

Partition: A nonstructural interior wall that spans from floor to ceiling, to the floor or roof structure immediately above, or to subsidiary structural members attached to the structure above.

P-delta effect: The secondary effect on shears and moments of structural members induced due to displacement of the structure.

Registered design professional: See Sec. 2.1.3.

Required strength: See Sec. 4.1.3.

Seismic Design Category: See Sec. 1.1.4.

Seismic-force-resisting system: See Sec. 1.1.4.

Seismic forces: See Sec. 1.1.4.

Seismic response coefficient: Coefficient C_S as determined in Sec. 5.2.2.1.

Shear wall: See Sec. 4.1.3.

Story: See Sec. 4.1.3.

Story shear: The summation of design lateral forces at levels above the story under consideration.

Structure: See Sec. 1.1.4.

5.1.3 Notation

A_o	The area of the load-carrying foundation.
A_B	The base area of the structure.
A_i	The area of shear wall i .
A_x	The torsional amplification factor.
a_d	The incremental factor related to P -delta effects in Sec. 5.2.6.2.
C_d	See Sec. 4.1.4.
C_r	The approximate period coefficient given in Sec. 5.2.2.1.
C_S	The seismic response coefficient.
C_{Sm}	The modal seismic response coefficient determined in Sec. 5.3.4.
C_u	Coefficient for upper limit on calculated period given in Table 5.2-1.
C_{vx}	The vertical distribution factor given in Sec. 5.2.3.
C_{vxm}	The vertical distribution factor in the m th mode given in Sec. 5.3.5.
C_w	The effective shear wall area coefficient defined in Sec. 5.2.2.1.
D_s	The total depth of the stratum in Eq. 5.6-10.
F_i	See Sec. 4.1.4.
F_x	See Sec. 1.1.5.
F_{xm}	The portion of the seismic base shear, V_m , induced at a Level x as determined in Sec. 5.3.5.
G	γ_s^2/g = the average shear modulus for the soils beneath the foundation at large strain levels.
G_o	γ_{so}^2/g = the average shear modulus for the soils beneath the foundation at small strain levels.
h_i	The height above the base to Level i .
h_n	The height above the base to the highest level of the structure.
h_x	The height above the base to Level x .
\bar{h}	The effective height of the structure as defined in Sec. 5.6.2.1.1.
I	See Sec. 1.1.5.
I_o	The static moment of inertia of the load-carrying foundation, see Sec. 5.6.2.1.1.
k	The distribution exponent given in Sec. 5.2.3.
\bar{k}	The stiffness of the fixed-base structure as defined in Sec. 5.6.2.1.1.
K_y	The lateral stiffness of the foundation as defined in Sec. 5.6.2.1.1.
K_θ	The rocking stiffness of the foundation as defined in Sec. 5.6.2.1.1.
L_i	The length of shear wall i .
L_o	The overall length of the side of the foundation in the direction being analyzed, Sec. 5.6.2.1.2.
M_o, M_{o1}	The overturning moment at the foundation-soil interface as determined in Sec. 5.2.5 and 5.3.6.

M_t	The torsional moment resulting from the location of the building masses, Sec. 5.2.4.1.
M_{ta}	The accidental torsional moment as determined in Sec. 5.2.4.2.
m	A subscript denoting the mode of vibration under consideration; i.e., $m=1$ for the fundamental mode.
N	Number of stories.
P_x	The total unfactored vertical design load at and above level x .
Q_E	See Sec. 4.1.4.
R	See Sec. 4.1.4.
r_a	The characteristic foundation length defined by Eq. 5.6-7.
r_m	The characteristic foundation length as defined by Eq. 5.6-8.
S_I	See Sec. 3.1.4.
S_{am}	The design spectral response acceleration at the period corresponding to mode m .
S_{DI}	See Sec. 3.1.4.
S_{DS}	See Sec. 3.1.4.
T	See Sec. 4.1.4.
\tilde{T}	The effective period of the flexibly supported structure as determined by Eq. 5.6-3.
T_a	The approximate fundamental period of the building as determined in Sec. 5.2.2.1.
T_m	The period of the m^{th} mode of vibration of the structure in the direction of interest.
V	The total design shear at the base of the structure in the direction of interest, as determined using the procedure of Sec. 5.2, including Sec. 5.2.1.
V_I	The portion of seismic base shear, V , contributed by the fundamental mode.
V_t	The design value of the seismic base shear as determined in Sec. 5.3.7.
V_x	The seismic design shear in Story x .
\tilde{V}	The total design base shear including consideration of soil-structure interaction.
ΔV	The reduction in V as determined in Sec. 5.6.2.1.
ΔV_I	The reduction of V_I as determined in Sec. 5.6.3.1.
v_s	See Sec. 3.1.4.
v_{so}	The average shear wave velocity for the soils beneath the foundation at small strain levels.
W	See Sec. 1.1.5.
\bar{W}	The effective seismic weight as defined in Sec. 5.6.2.1 and 5.6.3.1.
\bar{W}_m	The effective seismic weight of the m^{th} mode of vibration of the structure determined in accordance with Eq. 5.3-2.
w_i	See Sec. 4.1.4.
w_x	See Sec. 1.1.5.
Level x	See Sec. 1.1.5.
α	The relative weight density of the structure and the soil as determined in Sec. 5.6.2.1.1.

α_θ	The dynamic foundation stiffness modifier for rocking (see <i>Commentary</i>).
$\tilde{\beta}$	The fraction of critical damping for the coupled structure-foundation system, determined in Sec. 5.6.2.1.2.
β_o	The foundation damping factor as specified in Sec. 5.6.2.1.2.
γ	The average unit weight of soil.
γ	The member inelastic deformations.
Δ	See Sec. 4.1.4.
$\tilde{\Delta}_m$	The modal story drift including the effects of soil-structure interaction.
δ_{avg}	The average of the displacements at the extreme points of the structure at Level x .
δ_{max}	The maximum displacement at Level x .
δ_{xm}	The modal deflection of Level x at the center of the mass at and above Level x , as determined by Eq. 5.3-8.
$\bar{\delta}_{x1}$	The modified modal deflections (for the first mode) as determined by Eq. 5.6-14.
$\bar{\delta}_{xm}$	The modified modal deflections (for mode m) as determined by Eq. 5.6-15.
θ	The stability coefficient for P -delta effects as determined in Sec. 5.2.6.2.
θ_{max}	The maximum permitted stability coefficient as determined by Eq. 5.2-17.
τ	The overturning moment reduction factor.
ϕ	The strength reduction, capacity reduction, or resistance factor.
Ω_o	See Sec. 4.1.4.

5.2 EQUIVALENT LATERAL FORCE PROCEDURE

An equivalent lateral force analysis shall consist of the application of equivalent static lateral forces to a linear mathematical model of the structure. The lateral forces applied in each direction shall sum to a total seismic base shear given by Sec. 5.2.1 and shall be distributed vertically in accordance with Sec. 5.2.3. For purposes of analysis, the structure shall be considered fixed at the base.

5.2.1 Seismic base shear. The seismic base shear, V , in a given direction shall be determined in accordance with the following equation:

$$V = C_s W \quad (5.2-1)$$

where:

C_s = the seismic response coefficient determined in accordance with Sec. 5.2.1.1 and

W = the total dead load and applicable portions of other loads listed below:

1. In areas used for storage, a minimum of 25 percent of the floor live load shall be applicable. Floor live load in public garages and open parking structures is not applicable.
2. Where an allowance for partition load is included in the floor load design, the actual partition weight or a minimum weight of 10 psf (0.500 kN/m²) of floor area, whichever is greater, shall be applicable.
3. Total operating weight of permanent equipment.

4. In areas where the design flat roof snow load does not exceed 30 pounds per square foot, the effective snow load is permitted to be taken as zero. In areas where the design snow load is greater than 30 psf (1.4 kN/m²), where siting and load duration conditions warrant, and where approved by the authority having jurisdiction, the effective snow load is permitted to be reduced to not less than 20 percent of the design snow load.

5.2.1.1 Calculation of seismic response coefficient. The seismic response coefficient, C_s , shall be determined in accordance with the following equation:

$$C_s = \frac{S_{DS}}{R/I} \quad (5.2-2)$$

where:

S_{DS} = the design spectral response acceleration parameter in the short period range as determined from Sec. 3.3.3,

R = the response modification factor from Table 4.3-1, and

I = the occupancy importance factor determined in accordance with Sec. 1.3.

The value of the seismic response coefficient computed in accordance with Eq. 5.2-2 need not exceed the following:

$$C_s = \frac{S_{D1}}{T(R/I)} \text{ for } T \leq T_L \quad (5.2-3)$$

$$C_s = \frac{S_{D1}T_L}{T^2(R/I)} \text{ for } T > T_L \quad (5.2-4)$$

where R and I are as defined above and

S_{D1} = the design spectral response acceleration parameter at a period of 1.0 second as determined from Sec. 3.3.3,

T = the fundamental period of the structure (in seconds) determined in Sec. 5.2.2, and

T_L = Long-period transition period (in seconds) determined in Sec. 3.3.1

C_s shall not be taken less than 0.01.

For buildings and structures located where S_I is equal to or greater than 0.6g, C_s shall not be taken less than:

$$C_s = \frac{0.5S_I}{R/I} \quad (5.2-5)$$

where R and I are as defined above and

S_I = the mapped maximum considered earthquake spectral response acceleration parameter determined in accordance with Sec. 3.3.1.

For regular structures 5 stories or less in height and having a period, T , of 0.5 seconds or less, the seismic response coefficient, C_s , shall be permitted to be calculated using values of 1.5 and 0.6, respectively, for the mapped maximum considered earthquake spectral response acceleration parameters S_S and S_I .

A soil-structure interaction reduction is permitted where determined using Sec. 5.6 or other generally accepted procedures approved by the authority having jurisdiction.

5.2.2 Period determination. The fundamental period of the building, T , in the direction under consideration shall be established using the structural properties and deformational characteristics of the resisting elements in a properly substantiated analysis. The fundamental period, T , so calculated, shall not exceed the product of C_u , from Table 5.2-1, and T_a , calculated in accordance with Sec. 5.2.2.1. As an alternative to performing an analysis to determine the fundamental period of the structure, T , it shall be permitted to use the approximate period equations of Sec. 5.2.2.1 directly.

Table 5.2-1 Coefficient for Upper Limit on Calculated Period

Value of S_{DI} ^a	C_u
$S_{DI} \geq 0.4$	1.4
$S_{DI} = 0.3$	1.4
$S_{DI} = 0.2$	1.5
$S_{DI} = 0.15$	1.6
$S_{DI} \leq 0.1$	1.7

Note: ^a Use straight line interpolation for intermediate values of S_{DI} .

5.2.2.1 Approximate fundamental period. The approximate fundamental period, T_a , in seconds, shall be determined from the following equation:

$$T_a = C_r h_n^x \quad (5.2-6)$$

where h_n is the height in feet (meters) above the base to the highest level of the structure and the values of C_r and x shall be determined from Table 5.2-2.

Table 5.2-2 Values of Approximate Period Parameters C_r and x

Structure Type	C_r	x
Moment resisting frame systems of steel in which the frames resist 100 percent of the required seismic force and are not enclosed or adjoined by more rigid components that will prevent the frames from deflecting where subjected to seismic forces.	0.028 (metric 0.0724)	0.8
Moment resisting frame systems of reinforced concrete in which the frames resist 100 percent of the required seismic force and are not enclosed or adjoined by more rigid components that will prevent the frames from deflecting where subjected to seismic forces.	0.016 (metric 0.0466)	0.9
Eccentrically braced steel frames and buckling restrained braced frames	0.03 (metric 0.0731)	0.75
All other structural systems	0.02 (metric 0.0488)	0.75

Alternatively, the approximate fundamental period, T_a , in seconds, is permitted to be determined from the following equation for concrete and steel moment resisting frame structures not exceeding 12 stories in height and having a minimum story height of not less than 10 ft (3 m):

$$T_a = 0.1N \quad (5.2-7)$$

where N = number of stories.

The approximate fundamental period, T_a , in seconds, for masonry or concrete shear wall structures is permitted to be determined from the following equation:

$$T_a = \frac{0.0019}{\sqrt{C_w}} h_n \quad (5.2-8)$$

where C_w is a coefficient related to the effective shear wall area and h_n is as defined above. The metric equivalent of Eq. 5.2-8 is:

$$T_a = \frac{0.0062}{\sqrt{C_w}} h_n$$

The coefficient C_w shall be calculated from the following equation:

$$C_w = \frac{100}{A_B} \sum_{i=1}^n \left(\frac{h_n}{h_i} \right)^2 \frac{A_i}{\left[1 + 0.83 \left(\frac{h_i}{L_i} \right)^2 \right]} \quad (5.2-9)$$

where:

A_B = the base area of the structure,

A_i = the area of shear wall i ,

L_i = the length of shear wall i ,

h_n = the height above the base to the highest level of the structure,

h_i = the height of shear wall i , and

n = the number of shear walls in the building effective in resisting lateral forces in the direction under consideration.

5.2.3 Vertical distribution of seismic forces. The lateral force, F_x , induced at any level shall be determined from the following equations:

$$F_x = C_{vx} V \quad (5.2-10)$$

and

$$C_{vx} = \frac{w_x h_x^k}{\sum_{i=1}^n w_i h_i^k} \quad (5.2-11)$$

where:

C_{vx} = vertical distribution factor,

V = total design lateral force or shear at the base of the structure,

w_i and w_x = the portion of the total gravity load of the structure, W , located or assigned to Level i or x ,

- h_i and h_x = the height from the base to Level i or x , and
- k = an exponent related to the effective fundamental period of the structure as follows:
- For structures having a period of 0.5 seconds or less, $k = 1$
- For structures having a period of 2.5 seconds or more, $k = 2$
- For structures having a period between 0.5 and 2.5 seconds, k shall be determined by linear interpolation between 1 and 2 or may be taken equal to 2.

5.2.4 Horizontal shear distribution. The seismic design story shear in any story, V_x , shall be determined from the following equation:

$$V_x = \sum_{i=x}^n F_i \quad (5.2-12)$$

where F_i = the portion of the seismic base shear, V , induced at Level i .

The seismic design story shear, V_x , shall be distributed to the various vertical elements of the seismic-force-resisting system in the story under consideration based on the relative lateral stiffnesses of the vertical resisting elements and the diaphragm.

5.2.4.1 Inherent torsion. The distribution of lateral forces at each level shall consider the effect of the inherent torsional moment, M_t , resulting from eccentricity between the locations of the center of mass and the center of rigidity.

5.2.4.2 Accidental torsion. In addition to the inherent torsional moment, the distribution of lateral forces also shall include accidental torsional moments, M_{ta} , caused by an assumed displacement of the mass each way from its actual location by a distance equal to 5 percent of the dimension of the structure perpendicular to the direction of the applied forces.

5.2.4.3 Dynamic amplification of torsion. For structures assigned to Seismic Design Category C, D, E, or F, where Type 1 torsional irregularity exists as defined in Table 4.3-2, the effects of torsional irregularity shall be accounted for by multiplying the sum of M_t plus M_{ta} at each level by a torsional amplification factor, A_x , determined from the following equation:

$$A_x = \left(\frac{\delta_{max}}{1.2\delta_{avg}} \right)^2 \quad (5.2-13)$$

where:

- δ_{max} = the maximum displacement at Level x , and
- δ_{avg} = the average of the displacements at the extreme points of the structure at Level x .

The torsional amplification factor, A_x , is not required to exceed 3.0. The more severe loading for each element shall be considered for design.

5.2.5 Overturning. The structure shall be designed to resist overturning effects caused by the seismic forces determined in Sec. 5.2.3. At any story, the increment of overturning moment in the story under consideration shall be distributed to the various vertical force resisting elements in the same proportion as the distribution of the horizontal shears to those elements.

The overturning moments at Level x , M_x , shall be determined from Eq. 5.2-14 as follows:

$$M_x = \sum_{i=x}^n F_i (h_i - h_x) \quad (5.2-14)$$

where:

- F_i = the portion of the seismic base shear, V , induced at Level i , and
 h_i and h_x = the height from the base to Level i or x .

The foundations of structures, except inverted pendulum-type structures, shall be permitted to be designed for three-fourths of the foundation overturning design moment, M_0 , determined using Eq. 5.2-14 at the foundation-soil interface.

5.2.6 Drift determination and P-delta limit. Story drifts shall be determined in accordance with this section. Determination of story drifts shall be based on the application of the design seismic forces to a mathematical model of the physical structure. The model shall include the stiffness and strength of all elements that are significant to the distribution of forces and deformations in the structure and shall represent the spatial distribution of the mass and stiffness of the structure. In addition, the model shall comply with the following:

1. Stiffness properties of reinforced concrete and masonry elements shall consider the effects of cracked sections and
2. For steel moment resisting frame systems, the contribution of panel zone deformations to overall story drift shall be included.

5.2.6.1 Story drift determination. The design story drift, Δ , shall be computed as the difference of the deflections at the center of mass at the top and bottom of the story under consideration.

Exception: For structures of Seismic Design Category C, D, E or F having plan irregularity Type 1a or 1b of Table 4.3-2, the design story drift, Δ , shall be computed as the largest difference of the deflections along any of the edges of the structure at the top and bottom of the story under consideration.

The deflections of Level x , δ_x , shall be determined in accordance with following equation:

$$\delta_x = \frac{C_d \delta_{xe}}{I} \quad (5.2-15)$$

where:

- C_d = the deflection amplification factor from Table 4.3-1,
 δ_{xe} = the deflections determined by an elastic analysis, and
 I = the occupancy importance factor determined in accordance with Sec. 1.3.

The elastic analysis of the seismic-force-resisting system shall be made using the prescribed seismic design forces of Sec. 5.2.3.

For determining compliance with the story drift limits of Sec. 4.5.1, it shall be permitted to determine the elastic drifts, δ_{xe} , using seismic design forces based on the computed fundamental period of the structure without the upper limit ($C_u T_u$) specified in Sec. 5.2.2.

Where nonlinear analysis is required by Sec. 5.2.6.2 and the nonlinear static procedure is used, the design story drift, Δ , shall be determined according to Sec. A5.2.4.

5.2.6.2 P-delta limit. stability coefficient, θ , as determined for each level of the structure by the following equation, shall not exceed 0.10:

$$\theta = \frac{P_x \Delta I}{V_x h_{sx} C_d} \quad (5.2-16)$$

where:

- P_x = the total vertical design load at and above Level x . Where calculating the vertical design load for purposes of determining P-delta effects, the individual load factors need not exceed 1.0.
- Δ = the design story drift calculated in accordance with Sec. 5.2.6.1.
- I = the occupancy importance factor determined in accordance with Sec.1.3
- V_x = the seismic shear force acting between Level x and $x - 1$.
- h_{sx} = the story height below Level x .
- C_d = the deflection amplification factor from Table 4.3-1.

Exception: The stability coefficient θ , shall be permitted to exceed 0.10 if the resistance to lateral forces is determined to increase continuously in a monotonic nonlinear static (pushover) analysis to the target displacement as determined in Sec. A5.2.3. P-delta effects shall be included in the analysis.

5.3 RESPONSE SPECTRUM PROCEDURE

A modal response spectrum analysis shall consist of the analysis of a linear mathematical model of the structure to determine the maximum accelerations, forces, and displacements resulting from the dynamic response to ground shaking represented by the design response spectrum. The analysis shall be performed in accordance with the requirements of this section. For purposes of analysis, the structure shall be permitted to be considered to be fixed at the base or, alternatively, it shall be permitted to use realistic assumptions with regard to the stiffness of foundations. The symbols used in this section have the same meaning as those for similar terms used in Sec. 5.2 but with the subscript m denoting quantities relating to the m^{th} mode.

5.3.1 Modeling. A mathematical model of the structure shall be constructed that represents the spatial distribution of mass and stiffness throughout the structure. For regular structures with independent orthogonal seismic-force-resisting systems, independent two-dimensional models are permitted to be constructed to represent each system. For irregular structures or structures without independent orthogonal systems, a three-dimensional model incorporating a minimum of three dynamic degrees of freedom consisting of translation in two orthogonal plan directions and torsional rotation about the vertical axis shall be included at each level of the structure. Where the diaphragms are not rigid compared to the vertical elements of the lateral-force-resisting system, the model should include representation of the diaphragm's flexibility and such additional dynamic degrees of freedom as are required to account for the participation of the diaphragm in the structure's dynamic response. In addition, the model shall comply with the following:

1. Stiffness properties of concrete and masonry elements shall consider the effects of cracked sections and
2. The contribution of panel zone deformations to overall story drift shall be included for steel moment frame resisting systems.

5.3.2 Modes. An analysis shall be conducted to determine the natural modes of vibration for the structure including the period of each mode, the modal shape vector ϕ , the modal participation factor, and modal mass. The analysis shall include a sufficient number of modes to obtain a combined modal mass participation of at least 90 percent of the actual mass in each of two orthogonal directions.

5.3.3 Modal properties. The required periods, mode shapes, and participation factors of the structure shall be calculated by established methods of structural analysis for the fixed-base condition using the masses and elastic stiffnesses of the seismic-force-resisting system.

5.3.4 Modal base shear. The portion of the base shear contributed by the m^{th} mode, V_m , shall be determined from the following equations:

$$V_m = C_{sm} \bar{W}_m \quad (5.3-1)$$

$$\bar{W}_m = \frac{\left(\sum_{i=1}^n w_i \phi_{im} \right)^2}{\sum_{i=1}^n w_i \phi_{im}^2} \quad (5.3-2)$$

where:

- C_{sm} = the modal seismic response coefficient as determined in this section,
- \bar{W}_m = the effective modal gravity load including portions of the live load as defined in Sec. 5.2.1,
- w_i = the portion of the total gravity load of the structure at Level i , and
- ϕ_{im} = the displacement amplitude at the i^{th} level of the structure where vibrating in its m^{th} mode.

The modal seismic response coefficient, C_{sm} , shall be determined in accordance with the following equation:

$$C_{sm} = \frac{S_{am}}{R/I} \quad (5.3-3)$$

where:

- S_{am} = The design spectral response acceleration at period T_m determined from either Sec. 3.3.4 or Sec. 3.4.4,
- R = the response modification factor determined from Table 4.3-1,
- I = the occupancy importance factor determined in accordance with Sec. 1.3, and
- T_m = the modal period of vibration (in seconds) of the m^{th} mode of the structure.

Exceptions:

1. Where the standard design response spectrum of Sec. 3.3.4 is used for structures on Site Class D, E or F soils, the modal seismic design coefficient, C_{sm} , for modes other than the fundamental mode that have periods less than 0.3 seconds is permitted to be determined by the following equation:

$$C_{sm} = \frac{0.4 S_{DS}}{R/I} (1 + 5T_m) \quad (5.3-4)$$

where S_{DS} is as defined in Sec. 3.3.3 and R , I , and T_m are as defined above.

2. Where the standard design response spectrum of Sec. 3.3.4 is used for structures where any modal period of vibration, T_m , exceeds T_L , the modal seismic design coefficient, C_{sm} , for that mode is permitted to be determined by the following equation:

$$C_{sm} = \frac{S_{DI} T_L}{(R/I) T_m^2} \quad (5.3-5)$$

where R , I , and T_m are as defined above and S_{DI} is the design spectral response acceleration parameter at a period of 1 second as determined in Sec. 3.3.3. and T_L is the Long-period transition period as defined in Sec. 3.3.4.

The reduction due to soil-structure interaction as determined in Sec. 5.6.3 shall be permitted to be used.

5.3.5 Modal forces, deflections, and drifts. The modal force, F_{xm} , at each level shall be determined by the following equations:

$$F_{xm} = C_{vsm} V_m \quad (5.3-6)$$

and

$$C_{vsm} = \frac{w_x \phi_{xm}}{\sum_{i=1}^n w_i \phi_{im}} \quad (5.3-7)$$

where:

- C_{vsm} = the vertical distribution factor in the m^{th} mode,
- V_m = the total design lateral force or shear at the base in the m^{th} mode,
- w_i, w_x = the portion of the total gravity load, W , located or assigned to Level i or x ,
- ϕ_{xm} = the displacement amplitude at the x^{th} level of the structure where vibrating in its m^{th} mode, and
- ϕ_{im} = the displacement amplitude at the i^{th} level of the structure where vibrating in its m^{th} mode.

The modal deflection at each level, δ_{xm} , shall be determined by the following equations:

$$\delta_{xm} = \frac{C_d \delta_{xem}}{I} \quad (5.3-8)$$

and

$$\delta_{xem} = \left(\frac{g}{4\pi^2} \right) \left(\frac{T_m^2 F_{xm}}{w_x} \right) \quad (5.3-9)$$

where:

- C_d = the deflection amplification factor determined from Table 4.3-1,
- δ_{xem} = the deflection of Level x in the m^{th} mode at the center of the mass at Level x determined by an elastic analysis,
- g = the acceleration due to gravity,
- I = the occupancy importance factor determined in accordance with Sec. 1.3,
- T_m = the modal period of vibration, in seconds, of the m^{th} mode of the structure,
- F_{xm} = the portion of the seismic base shear in the m^{th} mode, induced at Level x , and
- w_x = the portion of the total gravity load of the structure, W , located or assigned to Level x .

The modal drift in a story, Δ_m , shall be computed as the difference of the deflections, δ_{xm} , at the top and bottom of the story under consideration.

5.3.6 Modal story shears and moments. The story shears, story overturning moments, and the shear forces and overturning moments in vertical elements of the structural system at each level due to the seismic forces determined from the appropriate equation in Sec. 5.3.5 shall be computed for each mode by linear static methods.

5.3.7 Design values. The design value for the modal base shear, V_i ; each of the story shear, moment, and drift quantities; and the deflection at each level shall be determined by combining their modal

values as obtained from Sec. 5.3.5 and 5.3.6. The combination shall be carried out by taking the square root of the sum of the squares of each of the modal values or by the complete quadratic combination technique. The complete quadratic combination shall be used where closely spaced periods in the translational and torsional modes will result in cross-correlation of the modes.

A base shear, V , shall be calculated using the equivalent lateral force procedure in Sec. 5.2. For the purpose of this calculation, the fundamental period of the structure, T , in seconds, shall not exceed the coefficient for upper limit on the calculated period, C_u , times the approximate fundamental period of the structure, T_a . Where the design value for the modal base shear, V_i , is less than 85 percent of the calculated base shear, V , using the equivalent lateral force procedure, the design story shears, moments, drifts, and floor deflections shall be multiplied by the following modification factor:

$$0.85 \frac{V}{V_i} \quad (5.3-10)$$

where:

V = the equivalent lateral force procedure base shear calculated in accordance with this section and Sec. 5.2 and

V_i = the modal base shear calculated in accordance with this section.

Where soil-structure interaction is considered in accordance with Sec. 5.6, the value of V may be taken as the reduced value of V .

5.3.8 Horizontal shear distribution. The distribution of horizontal shear shall be in accordance with the requirements of Sec. 5.2.4 except that amplification of torsion per Sec. 5.2.4.3 is not required for that portion of the torsion included in the dynamic analysis model.

5.3.9 Foundation overturning. The foundation overturning moment at the foundation-soil interface shall be permitted to be reduced by 10 percent.

5.3.10 P-delta effects. The P-delta effects shall be determined in accordance with Sec. 5.2.6. The story drifts and story shears shall be determined in accordance with Sec. 5.2.6.1.

5.4 LINEAR RESPONSE HISTORY PROCEDURE

A linear response history analysis shall consist of an analysis of a linear mathematical model of the structure to determine its response, through methods of numerical integration, to suites of ground motion acceleration histories compatible with the design response spectrum for the site. The analysis shall be performed in accordance with the provisions of this section. For the purposes of analysis, the structure shall be permitted to be considered to be fixed at the base or, alternatively, it shall be permitted to use realistic assumptions with regard to the stiffness of foundations.

5.4.1 Modeling. Mathematical models shall conform to the requirements of Sec. 5.3.1.

5.4.2 Ground motion. A suite of not fewer than three appropriate ground motions shall be used in the analysis. Ground motion shall conform to the requirements of this section.

5.4.2.1 Two-dimensional analysis. Where two-dimensional analyses are performed, each ground motion shall consist of a horizontal acceleration history selected from an actual recorded event. Appropriate acceleration histories shall be obtained from records of events having magnitudes, fault distance, and source mechanisms that are consistent with those that control the maximum considered earthquake. Where the required number of appropriate recorded ground motion records are not available, appropriate simulated ground motion records shall be used to make up the total number required. The ground motions shall be scaled such that for each period between $0.2T$ and $1.5T$ (where T is the natural period of the structure in the fundamental mode for the direction of response being analyzed) the average of the five-percent-damped response spectra for the suite of motions is not less

than the corresponding ordinate of the design response spectrum, determined in accordance with Sec. 3.3.4 or 3.4.4.

5.4.2.2 Three-dimensional analysis. Where three-dimensional analysis is performed, ground motions shall consist of pairs of appropriate horizontal ground motion acceleration components that shall be selected and scaled from individual recorded events. Appropriate ground motions shall be selected from events having magnitudes, fault distance, and source mechanisms that are consistent with those that control the maximum considered earthquake. Where the required number of recorded ground motion pairs are not available, appropriate simulated ground motion pairs shall be used to make up the total number required. For each pair of horizontal ground motion components, an SRSS spectrum shall be constructed by taking the square root of the sum of the squares of the five-percent-damped response spectra for the components (where an identical scale factor is applied to both components of a pair). Each pair of motions shall be scaled such that for each period between $0.2T$ and $1.5T$ (where T is the natural period of the fundamental mode of the structure) the average of the SRSS spectra from all horizontal component pairs is not less than 1.3 times the corresponding ordinate of the design response spectrum, determined in accordance with Sec. 3.3.4 or 3.4.4.

5.4.3 Response parameters. For each ground motion analyzed, the individual response parameters shall be scaled by the quantity I/R where I is the occupancy importance factor determined in accordance with Sec. 1.3 and R is the response modification coefficient selected in accordance with Sec. 4.3-1. The maximum value of the base shear, V_i , member forces, Q_{Ei} , and the interstory drifts, δ_i , at each story scaled as indicated above shall be determined. Where the maximum scaled base shear predicted by the analysis, V_i , is less than that given by Eq. 5.2-4 or, in Seismic Design Categories E and F, Eq. 5.2-5, the scaled member forces, Q_{Ei} , shall be additionally scaled by the factor V/V_i where V is the minimum base shear determined in accordance with Eq. 5.2-4 or, for structures in Seismic Design Category E or F, Eq. 5.2-5.

If at least seven ground motions are analyzed, the design member forces, Q_E , used in the load combinations of Sec. 4.2.2 and the design interstory drift, Δ , used in the evaluation of drift in accordance with Sec. 4.5.1 shall be permitted to be taken, respectively, as the average of the scaled Q_{Ei} and δ_i values determined from the analyses and scaled as indicated above. If fewer than seven ground motions are analyzed, the design member forces, Q_E , and the design interstory drift, Δ , shall be taken as the maximum value of the scaled Q_{Ei} and δ_i values determined from the analyses.

Where these *Provisions* require the consideration of the seismic load effect with overstrength as defined in Sec. 4.2.2.2, the value of $\Omega_0 Q_E$ need not be taken larger than the maximum of the unscaled value, Q_{Ei} , obtained from the suite of analyses.

5.5 NONLINEAR RESPONSE HISTORY PROCEDURE

A nonlinear response history analysis shall consist of an analysis of a mathematical model of the structure that directly accounts for the nonlinear hysteretic behavior of the structure's components to determine its response, through methods of numerical integration, to suites of ground motion acceleration histories compatible with the design response spectrum for the site. The analysis shall be performed in accordance with the requirements of this section.

5.5.1 Modeling. A mathematical model of the structure shall be constructed that represents the spatial distribution of mass throughout the structure. The hysteretic behavior of elements shall be modeled consistent with suitable laboratory test data and shall account for all significant yielding, strength degradation, stiffness degradation, and hysteretic pinching indicated by such test data. Strength of elements shall be based on expected values considering material overstrength, strain hardening, and hysteretic strength degradation. Linear properties, consistent with the provisions of Section 5.3.1 shall be permitted to be used for those elements demonstrated by the analysis to remain within their linear range of response. The structure shall be assumed to have a fixed base or, alternatively, it shall be

permitted to use realistic assumptions with regard to the stiffness and load carrying characteristics of the foundations consistent with site-specific soils data and rational principles of engineering mechanics.

For regular structures with independent orthogonal seismic-force-resisting systems, independent two-dimensional models shall be permitted to be constructed to represent each system. For structures having plan irregularity Type 1a, 1b, 4, or 5 of Table 4.3-2 or structures without independent orthogonal systems, a three-dimensional model incorporating a minimum of three dynamic degrees of freedom consisting of translation in two orthogonal plan directions and torsional rotation about the vertical axis at each level of the structure shall be used. Where the diaphragms are not rigid compared to the vertical elements of the lateral-force-resisting system, the model shall include representation of the diaphragm's flexibility and such additional dynamic degrees of freedom as are required to account for the participation of the diaphragm in the structure's dynamic response.

5.5.2 Ground motion and other loading. Ground motion shall conform to the requirements of Sec. 5.4.2. The structure shall be analyzed for the effects of these ground motions simultaneously with the effects of dead load in combination with not less than 25 percent of the required live loads.

5.5.3 Response parameters. For each ground motion analyzed, individual response parameters consisting of the maximum value of the individual member forces, Q_{Ei} , member inelastic deformations, γ_i , and story drifts, Δ_i , shall be determined.

If at least seven ground motions are analyzed, the design values of member forces, Q_E , member inelastic deformations, γ , and story drift, Δ , shall be permitted to be taken, respectively, as the average of the scaled Q_{Ei} , γ_i , and Δ_i values determined from the analyses. If fewer than seven ground motions are analyzed, the design member forces, Q_E , design member inelastic deformations, γ , and the design story drift, Δ , shall be taken as the maximum value of the scaled Q_{Ei} , γ_i , and Δ_i values determined from the analyses.

5.5.3.1 Member strength. The adequacy of members to resist the load combinations of Sec 4.2.2 need not be evaluated.

Exception: Where the *Provisions* require the consideration of the seismic load effect with overstrength, determined in accordance with Sec. 4.2.2.2, the maximum value of Q_{Ei} obtained from the suite of analyses shall be taken in place of the quantity $\Omega_0 Q_E$.

5.5.3.2 Member deformation. The adequacy of individual members and their connections to withstand the design deformations, γ , predicted by the analyses shall be evaluated based on laboratory test data for similar components. The effects of gravity and other loads on member deformation capacity shall be considered in these evaluations. Member deformation shall not exceed two thirds of the lesser of: the value that results in loss of ability to carry gravity loads or the value at which member strength has deteriorated to less than the 67 percent of the peak strength.

5.5.3.3 Story drift. The design story drifts, Δ , obtained from the analyses shall not exceed 125 percent of the drift limit specified in Sec. 4.5.1.

5.5.4 Design review. A review of the design of the seismic-force-resisting system and the supporting structural analyses shall be performed by an independent team consisting of registered design professionals in the appropriate disciplines and others with experience in seismic analysis methods and the theory and application of nonlinear seismic analysis and structural behavior under extreme cyclic loads. The design review shall include, but need not be limited to, the following:

1. Review of any site-specific seismic criteria employed in the analysis including the development of site-specific spectra and ground motion time histories,
2. Review of acceptance criteria used to demonstrate the adequacy of structural elements and systems to withstand the calculated force and deformation demands, together with laboratory and other data used to substantiate such criteria,

3. Review of the preliminary design including the determination of the target displacement of the structure and the margins remaining beyond these displacements, and
4. Review of the final design of the entire structural system and all supporting analyses.

5.6 SOIL-STRUCTURE INTERACTION EFFECTS

5.6.1 General. The requirements set forth in this section are permitted to be used to incorporate the effects of soil-structure interaction in the determination of the design earthquake forces and the corresponding displacements of the structure when the model used for structural response analysis does not directly incorporate the effects of foundation flexibility (i.e., the model corresponds to a fixed-base condition with no foundation springs). The use of these requirements will decrease the design values of the base shear, lateral forces, and overturning moments but may increase the computed values of the lateral displacements and the secondary forces associated with the P-delta effects.

The requirements for use with the equivalent lateral force procedure are given in Sec. 5.6.2 and those for use with the response spectrum procedure are given in Sec. 5.6.3. The provisions in Sec. 5.6 shall not be used if a flexible-base, rather than a fixed base, foundation is directly modeled in the structural response analysis.

5.6.2 Equivalent lateral force procedure. The following requirements are supplementary to those presented in Sec. 5.2.

5.6.2.1 Base shear. To account for the effects of soil-structure interaction, the base shear, V , determined from Eq. 5.2-1 may be reduced to:

$$\tilde{V} = V - \Delta V \quad (5.6-1)$$

where the reduction, ΔV , shall be computed as follows:

$$\Delta V = \left[C_s - \tilde{C}_s \left(\frac{0.05}{\tilde{\beta}} \right)^{0.4} \right] \bar{W} \quad (5.6-2)$$

where:

- C_s = the seismic response coefficient computed from Eq. 5.2-2 using the fundamental natural period of the fixed-base structure as specified in Sec. 5.2.2,
- \tilde{C}_s = the seismic response coefficient computed from Eq. 5.2-2 using the effective period of the flexibly supported structure defined in Sec. 5.6.2.1.1,
- $\tilde{\beta}$ = the fraction of critical damping for the structure-foundation system determined in Sec. 5.6.2.1.2, and
- \bar{W} = the effective gravity load of the structure, which shall be taken as $0.7W$, except that for structures where the gravity load is concentrated at a single level, it shall be taken equal to W .

The reduced base shear, \tilde{V} , shall in no case be taken less than $0.7V$.

5.6.2.1.1 Effective building period. The effective period of the flexibly supported structure, \tilde{T} , shall be determined as follows:

$$\tilde{T} = T \sqrt{1 + \frac{\bar{k}}{K_y} \left(1 + \frac{K_y \bar{h}^2}{K_\theta} \right)} \quad (5.6-3)$$

where:

T = the fundamental period of the structure as determined in Sec. 5.2.2;

\bar{k} = the stiffness of the fixed-base structure, defined by the following:

$$\bar{k} = 4\pi^2 \left(\frac{\bar{W}}{gT^2} \right) \quad (5.6-4)$$

\bar{h} = the effective height of the structure which shall be taken as 0.7 times the total height, h_n , except that for structures where the gravity load is effectively concentrated at a single level, it shall be taken as the height to that level;

K_y = the lateral stiffness of the foundation defined as the horizontal force at the level of the foundation necessary to produce a unit deflection at that level, the force and the deflection being measured in the direction in which the structure is analyzed;

K_θ = the rocking stiffness of the foundation defined as the moment necessary to produce a unit average rotation of the foundation, the moment and rotation being measured in the direction in which the structure is analyzed; and

g = the acceleration due to gravity.

The foundation stiffnesses, K_y and K_θ , shall be computed by established principles of foundation mechanics (see the *Commentary*) using soil properties that are compatible with the soil strain levels associated with the design earthquake motion. The average shear modulus, G , for the soils beneath the foundation at large strain levels and the associated shear wave velocity, v_s , needed in these computations shall be determined from Table 5.6-1 where:

v_{so} = the average shear wave velocity for the soils beneath the foundation at small strain levels (10^{-3} percent or less),

$G_o = \gamma v_{so}^2 / g$ = the average shear modulus for the soils beneath the foundation at small strain levels, and

γ = the average unit weight of the soils.

Table 5.6-1 Values of G/G_o and v_s/v_{so}

	$S_{DS}/2.5$			
	≤ 0.10	0.15	0.20	≥ 0.30
Value of G/G_o	0.81	0.64	0.49	0.42
Value of v_s/v_{so}	0.90	0.80	0.70	0.65

Alternatively, for structures supported on mat foundations that rest at or near the ground surface or are embedded in such a way that the side wall contact with the soil cannot be considered to remain effective during the design ground motion, the effective period of the structure may be determined from:

$$\tilde{T} = T \sqrt{1 + \frac{25\alpha}{v_s^2 T^2} \frac{r_a \bar{h}}{\alpha_\theta r_m^3} \left(1 + \frac{1.12 r_a \bar{h}^2}{\alpha_\theta r_m^3} \right)} \quad (5.6-5)$$

where:

α = the relative weight density of the structure and the soil, defined by:

$$\alpha = \frac{\bar{W}}{\gamma A_o \bar{h}} \quad (5.6-6)$$

r_a and r_m = characteristic foundation lengths, defined by:

$$r_a = \sqrt{\frac{A_o}{\pi}} \quad (5.6-7)$$

and

$$r_m = \sqrt[4]{\frac{4I_o}{\pi}} \quad (5.6-8)$$

where:

A_o = the area of the foundation,

I_o = the static moment of the foundation about a horizontal centroidal axis normal to the direction in which the structure is analyzed, and

α_θ = dynamic foundation stiffness modifier for rocking (see *Commentary*).

5.6.2.1.2 Effective damping. The effective damping factor for the structure-foundation system, $\tilde{\beta}$, shall be computed as follows:

$$\tilde{\beta} = \beta_o + \frac{0.05}{\left(\frac{\tilde{T}}{T}\right)^3} \quad (5.6-9)$$

where β_o = the foundation damping factor as specified in Figure 5.6-1.

For values of $S_{DS}/2.5$ between 0.10 and 0.20, values of β_o shall be determined by linear interpolation between the solid lines and the dashed lines of Figure 5.6-1.

The quantity r in Figure 5.6-1 is a characteristic foundation length that shall be determined as follows:

$$\text{For } \frac{\bar{h}}{L_o} \leq 0.5, r = r_a$$

$$\text{For } \frac{\bar{h}}{L_o} \geq 1.0, r = r_m$$

For intermediate values of $\frac{\bar{h}}{L_o}$, r shall be determined by linear interpolation.

where:

L_o = the overall length of the side of the foundation in the direction being analyzed, and

r_a and r_m = characteristic foundation lengths, defined in Sec. 5.6.2.1.1.

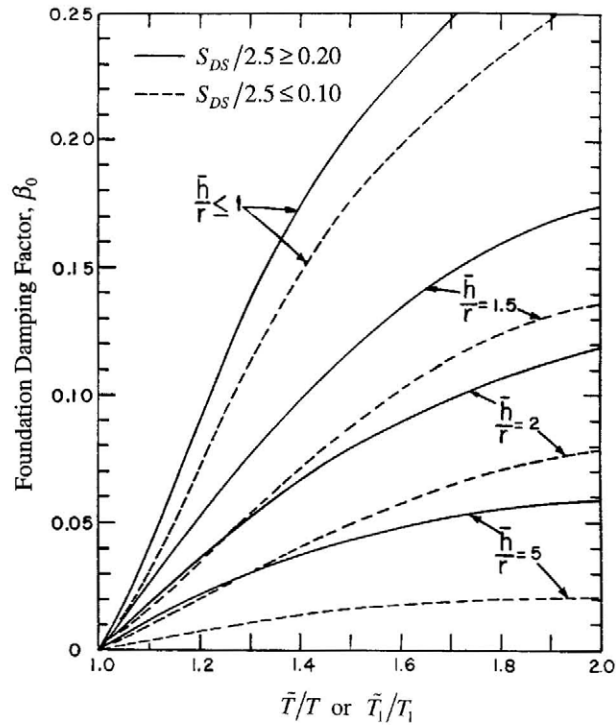

Figure 5.6-1 Foundation Damping Factor

Exception: For structures supported on point bearing piles and in all other cases where the foundation soil consists of a soft stratum of reasonably uniform properties underlain by a much stiffer, rock-like deposit with an abrupt increase in stiffness, the factor β_o in Eq. 5.6-9 shall be replaced by:

$$\beta'_o = \left(\frac{4D_s}{v_s \tilde{T}} \right)^2 \beta_o \quad (5.6-10)$$

if $\frac{4D_s}{v_s \tilde{T}} < 1$, where D_s is the total depth of the stratum.

The value of $\tilde{\beta}$ computed from Eq. 5.6-9, with or without the adjustment represented by Eq. 5.6-10, shall in no case be taken less than 0.05 or greater than 0.20.

5.6.2.2 Vertical distribution of seismic forces. The distribution over the height of the structure of the reduced total seismic force, \tilde{V} , shall be considered to be the same as for the fixed-base structure.

5.6.2.3 Other effects. The modified story shears, overturning moments, and torsional effects about a vertical axis shall be determined as for structures without interaction using the reduced lateral forces.

The modified deflections, $\tilde{\delta}_x$, shall be determined as follows:

$$\tilde{\delta}_x = \frac{\tilde{V}}{V} \left(\frac{M_o h_x}{K_\theta} + \delta_x \right) \quad (5.6-11)$$

where:

- M_o = the overturning moment at the base determined in accordance with Sec. 5.2.5 using the unmodified seismic forces and not including the reduction permitted in the design of the foundation,
- h_x = the height above the base to the level under consideration, and
- δ_x = the deflections of the fixed-base structure as determined in Sec. 5.2.6.1 using the unmodified seismic forces.

The modified story drifts and P-delta effects shall be evaluated in accordance with the requirements of Sec. 5.2.6 using the modified story shears and deflections determined in this section.

5.6.3 Response spectrum procedure. The following requirements are supplementary to those presented in Sec. 5.3.

5.6.3.1 Modal base shears. To account for the effects of soil-structure interaction, the base shear corresponding to the fundamental mode of vibration, V_1 , is permitted to be reduced to:

$$\tilde{V}_1 = V_1 - \Delta V_1 \quad (5.6-12)$$

The reduction, ΔV_1 , shall be computed in accordance with Eq. 5.6-2 with \bar{W} taken as equal to the gravity load \bar{W}_1 defined by Eq. 5.3-2, C_s computed from Eq. 5.3-3 using the fundamental period of the fixed-base structure, T_1 , and \tilde{C}_s computed from Eq. 5.3-3 using the fundamental period of the flexibly supported structure, \tilde{T}_1 .

The period \tilde{T}_1 shall be determined from Eq. 5.6-3, or from Eq. 5.6-5 where applicable, taking $T = \tilde{T}_1$, evaluating \bar{k} from Eq. 5.6-4 with $\bar{W} = \bar{W}_1$, and computing \bar{h} as follows:

$$\bar{h} = \frac{\sum_{i=1}^n w_i \phi_{i1} h_i}{\sum_{i=1}^n w_i \phi_{i1}} \quad (5.6-13)$$

The above designated values of \bar{W} , \bar{h} , T , and \tilde{T} also shall be used to evaluate the factor α from Eq. 5.6-6 and the factor β_o from Figure 5.6-1. No reduction shall be made in the shear components contributed by the higher modes of vibration. The reduced base shear, \tilde{V}_1 , shall in no case be taken less than $0.7V_1$.

5.6.3.2 Other modal effects. The modified modal seismic forces, story shears, and overturning moments shall be determined as for structures without interaction using the modified base shear, \tilde{V}_1 , instead of V_1 . The modified modal deflections, $\tilde{\delta}_{xm}$, shall be determined as follows:

$$\tilde{\delta}_{x1} = \frac{\tilde{V}_1}{V_1} \left(\frac{M_o h_x}{K_\theta} + \delta_{x1} \right) \quad (5.6-14)$$

and

$$\tilde{\delta}_{xm} = \delta_{xm} \text{ for } m = 2, 3, \dots \quad (5.6-15)$$

where:

- M_{o1} = the overturning base moment for the fundamental mode of the fixed-base structure, as determined in Sec. 5.3.6 using the unmodified modal base shear V_1 , and

δ_{xm} = the modal deflections at Level x of the fixed-base structure as determined in Sec. 5.3.5 using the unmodified modal shears, V_m .

The modified modal drift in a story, $\tilde{\Delta}_m$, shall be computed as the difference of the deflections, $\tilde{\delta}_{xm}$, at the top and bottom of the story under consideration.

5.6.3.3 Design values The design values of the modified shears, moments, deflections, and story drifts shall be determined as for structures without interaction by taking the square root of the sum of the squares of the respective modal contributions. In the design of the foundation, the overturning moment at the foundation-soil interface determined in this manner may be reduced by 10 percent as for structures without interaction.

The effects of torsion about a vertical axis shall be evaluated in accordance with the requirements of Sec. 5.2.4 and the P-delta effects shall be evaluated in accordance with the requirements of Sec. 5.2.6.1, using the story shears and drifts determined in Sec. 5.6.3.2.

This page is intentionally left blank.

Appendix to Chapter 5

NONLINEAR STATIC PROCEDURE

PREFACE: This appendix addresses nonlinear static analysis, a seismic analysis procedure also sometimes known as pushover analysis, for review and comment and for adoption into a subsequent edition of the *Provisions*.

Although nonlinear static analysis has only recently been included in design provisions for new building construction, the procedure itself is not new and has been used for many years in both research and design applications. For example, nonlinear static analysis has been used for many years as a standard methodology in the design of the offshore platform structures for hydrodynamic effects and has been adopted recently in several standard methodologies for the seismic evaluation and -rehabilitation of building structures, including the *Recommended Seismic Design Criteria for New Steel Moment-Frame Buildings* (FEMA-350, 2000a), *Prestandard and Commentary for the Seismic Rehabilitation of Buildings* (FEMA 356, 2000b) and *Seismic Evaluation and Retrofit of Concrete Buildings* (ATC 40, 1996). Nonlinear static analysis forms the basis for earthquake loss estimation procedures contained in *HAZUS* (NIBS, 1999), FEMA's nationally applicable earthquake loss estimation model. Although it does not explicitly appear in the *Provisions*, the nonlinear static analysis methodology also forms the basis for the equivalent lateral force procedures contained in the provisions for base-isolated structures and structures with dampers.

One of the controversies surrounding the introduction of this methodology into the *Provisions* relates to the determination of the limit deformation (sometimes called a target displacement). Several methodologies for estimating the amount of deformation induced in a structure by earthquake-induced ground shaking have been proposed and are included in various adoptions of the procedure. The approach presented in this appendix is based on statistical correlations of the displacements predicted by linear and nonlinear dynamic analyses of structures, which is similar to that contained in FEMA 356.

A second controversy relates to the limited availability of consensus-based acceptance criteria to be used to determine the adequacy of a design once the forces and deformations produced by design earthquake ground shaking are estimated. It should be noted that this limitation applies equally to the nonlinear response history approach, which already has been adopted into building codes.

Nonlinear static analysis provides a simplified method of directly evaluating nonlinear response of structures to strong earthquake ground shaking that can be an attractive alternative to the more complex procedures of nonlinear response history analysis. It is hoped that exposure of this approach

through inclusion in this appendix will allow the necessary consensus to be developed to permit later integration into the *Provisions* as such.

Users of this appendix also should consult the *Commentary* for guidance. Please direct all feedback on this appendix and its commentary to the BSSC.

A5.1 GENERAL

A5.1.1 Scope. This appendix provides guidelines for the use of the nonlinear static procedure for the analysis and design of structures.

A5.1.2 Definitions

Base: See Sec. 4.1.3.

Base shear: See Sec. 4.1.3.

Building: See Sec. 4.1.3.

Capacity curve: A plot of the total applied lateral force, V_j , versus the lateral displacement of the control point, δ_j , as determined in a nonlinear static analysis.

Component: See Sec. 1.1.4.

Control point: A point used to index the lateral displacement of the structure in a nonlinear static analysis, determined according to Sec. 5.2.1.

Dead load: See Sec. 4.1.3.

Design earthquake ground motion: See Sec. 1.1.4.

Diaphragm: See Sec. 4.1.3.

Effective Yield Displacement: The displacement of the control point at the intersection of the first and second branches of a bilinear curve that is fitted to the capacity curve according to Sec. A5.2.3.

Effective Yield Strength: The total applied lateral force at the intersection of the first and second branches of a bilinear curve that is fitted to the capacity curve according to Sec. A5.2.3.

Live load: See Sec. 4.1.3.

Registered design professional: See Sec. 2.1.3.

Seismic-force-resisting system: See Sec. 1.1.4.

Story: See Sec. 4.1.3.

Structure: See Sec. 1.1.4.

Target displacement: An estimate of the maximum expected displacement of the control point calculated for the design earthquake ground motion.

A5.1.3 Notation

C_d See Sec. 4.1.4.

C_s See Sec. 5.1.3

C_0 A modification factor to relate the displacement of the control point to the displacement of a representative single-degree-of-freedom system, as determined by Eq. A5.2-3.

C_I A modification factor to account for the influence of inelastic behavior on the response of the system, as determined by Eq. A5.2-4.

g acceleration of gravity.

j The increment of lateral loading.

Q_E See Sec. 4.1.4.

Q_{Ei} individual member forces, determined according to Sec. A5.2.9.1

R See Sec. 4.1.4.

R_d The system ductility factor as determined by Eq. A5.2.-5.

S_a See Sec. 3.1.4.

T_I The fundamental period of the structure in the direction under consideration.

T_e The effective fundamental period of the structure in the direction under consideration, as determined according to Sec. A5.2.3.

T_S See Sec. 3.1.4.

V_j	The total applied lateral force at load increment j .
V_I	The total applied lateral force at the first increment of lateral load.
V_y	The effective yield strength determined from a bilinear curve fitted to the capacity curve according to Sec. A5.2.3.
W	See Sec. 1.1.5.
w_i	See Sec. 4.1.4.
Δ	The design story drift as determined in Sec. A5.2.6.
γ_i	The deformations for member i .
δ_j	The displacement of the control point at load increment j .
δ_T	The target displacement of the control point, determined according to Sec. A5.2.5.
δ_I	The displacement of the control point at the first increment of lateral load.
δ_y	The effective yield displacement of the control point determined from a bilinear curve fitted to the capacity curve according to Sec. A5.2.3.
ϕ	The amplitude of the shape vector at Level i , determined according to Sec. A5.2.4.
Ω_0	See Sec. 4.1.4.

A5.2 NONLINEAR STATIC PROCEDURE

Where the nonlinear static procedure is used to design structures, the requirements of this section shall apply.

A5.2.1 Modeling. A mathematical model of the structure shall be constructed to represent the spatial distribution of mass and stiffness of the structural system considering the effects of component nonlinearity for deformation levels that exceed the proportional limit. P-Delta effects shall be included in the analysis.

For regular structures with independent orthogonal seismic-force-resisting systems, independent two-dimensional models shall be permitted to be used to represent each system. For structures having plan irregularities Types 4 and 5 as defined in Table 4.3-2 or structures without independent orthogonal systems, a three-dimensional model incorporating a minimum of three degrees of freedom for each level of the structure, consisting of translation in two orthogonal plan directions and torsional rotation about the vertical axis, shall be used. Where the diaphragms are not rigid compared to the vertical elements of the seismic-force-resisting system, the model should include representation of the diaphragm flexibility.

Unless analysis indicates that a component remains elastic, a nonlinear force deformation model shall be used to represent the stiffness of the component before onset of yield, the yield strength, and the stiffness properties of the component after yield at various levels of deformation. The properties of nonlinear component models shall be consistent with principles of mechanics or laboratory data. Properties representing component behavior before yield shall be consistent with the provisions of Sec. 5.3.1. Strengths of elements shall not exceed expected values considering material overstrength and strain hardening. The properties of elements and components after yielding shall account for strength and stiffness degradation due to softening, buckling, or fracture as indicated by principles of mechanics or test data. The model for columns should reflect the influence of axial load where axial loads exceed 15 percent of the compression strength. The structure shall be assumed to have a fixed base or, alternatively, it shall be permitted to use realistic assumptions with regard to the stiffness and load-carrying characteristics of the foundations, consistent with site-specific soil data and rational principles of engineering mechanics.

A control point shall be selected for each model. For structures without penthouses, the control point shall be at the center of mass of the highest level of the structure. For structures with penthouses, the control point shall be at the center of mass of the level at the base of the penthouse.

A5.2.2 Analysis. The structure shall be analyzed for seismic actions occurring simultaneously with the effects of dead load in combination with not less than 25 percent of the required design live loads, reduced as permitted for the area of a single floor. The lateral forces shall be applied at the center of mass of each level and shall be proportional to the distribution obtained from a modal analysis for the fundamental mode of response in the direction under consideration. The lateral loads shall be increased incrementally in a monotonic manner.

At the j -th increment of lateral loading, the total lateral force applied to the model shall be characterized by the term V_j . The incremental increases in applied lateral force should be in steps that are sufficiently small to permit significant changes in individual component behavior (such as yielding, buckling or failure) to be detected. The first increment in lateral loading shall result in linear elastic behavior. At each analysis step, the total applied lateral force, V_j , the lateral displacement of the control point, δ_j , and the forces and deformations in each component shall be recorded. The analysis shall be continued until the displacement of the control point is at least 150 percent of the target displacement determined in accordance with Sec. A5.2.5. The structure shall be designed so that the total applied lateral force does not decrease in any analysis increment for control point displacements less than or equal to 125 percent of the target displacement.

A5.2.3 Effective yield strength and effective period. A bilinear curve shall be fitted to the capacity curve, such that the first segment of the bilinear curve coincides with the capacity curve at 60 percent of the effective yield strength, the second segment coincides with the capacity curve at the target displacement, and the area under the bilinear curve equals the area under the capacity curve, between the origin and the target displacement. The effective yield strength, V_y , corresponds to the total applied lateral force at the intersection of the two line segments. The effective yield displacement, δ_y , corresponds to the control point displacement at the intersection of the two line segments.

The effective fundamental period, T_e , shall be determined using Eq. A5.2-1 as follows:

$$T_e = T_1 \sqrt{\frac{V_1 / \delta_1}{V_y / \delta_y}} \quad (\text{A5.2-1})$$

where V_1 , δ_1 , and T_1 are determined for the first increment of lateral load.

A5.2.4 Shape vector. The shape vector shall be equal to the first mode shape of the structure in the direction under consideration, determined by a modal analysis of the structure at the first increment of lateral load, and normalized to have unit amplitude at the level of the control point. It shall be permitted to substitute the deflected shape of the structure at the step at which the control point displacement is equal to the effective yield displacement in place of the mode shape, for determination of the shape vector.

A5.2.5 Target displacement. The target displacement of the control point, δ_T , shall be determined using Equation A5.2-2 as follows:

$$\delta_T = C_0 C_1 S_a \left(\frac{T_e}{2\pi} \right)^2 g \quad (\text{A5.2-2})$$

where the spectral acceleration, S_a , is determined from either Sec. 3.3.4 or Sec. 3.4.4 at the effective fundamental period, T_e , g is the acceleration of gravity, and the coefficients C_0 and C_1 are determined as follows.

The coefficient C_0 shall be calculated using Equation A5.2-3 as:

$$C_0 = \frac{\sum_{i=1}^n w_i \phi_i}{\sum_{i=1}^n w_i \phi_i^2} \quad (\text{A5.2-3})$$

where:

- w_i = the portion of the seismic weight, W , at Level i , and
- ϕ_i = the amplitude of the shape vector at Level i .

Where the effective fundamental period of the structure in the direction under consideration, T_e , is greater than T_s , as defined in Sec. 3.3.4 or Sec. 3.4.4, the coefficient C_1 shall be taken as 1.0. Otherwise, the value of the coefficient C_1 shall be calculated using Eq. A5.2-4 as follows:

$$C_1 = \frac{1}{R_d} \left(1 + \frac{(R_d - 1)T_s}{T_e} \right) \quad (\text{A5.2-4})$$

where R_d is given by Eq. A5.2-5 as follows:

$$R_d = \frac{S_a}{V_y / W} \quad (\text{A5.2-5})$$

and T_s and V_y are defined above, S_a is the design spectral acceleration at the effective fundamental period, T_e , and W is defined in Sec. 5.2.

A5.2.6 Story drift. The design story drift, Δ , taken as the value obtained for each story at the step at which the target displacement is reached shall not exceed the drift limit specified in Sec. 4.5.1 multiplied by $0.85R/C_d$.

A5.2.7 Member strength. In addition to satisfying the requirements of this Appendix, member strengths also shall satisfy the requirements of Sec. 4.2.2 using $E = 0$, except that Section 4.2.2.2 shall apply where these *Provisions* specifically require the consideration of structural overstrength on the design seismic force.

Where these *Provisions* require the consideration of structural overstrength according to Sec. 4.2.2.2, the value of the individual member forces, Q_{Ei} obtained from the analysis at the target displacement shall be taken in place of the quantity $\Omega_0 Q_E$.

A5.2.8 Distribution of design seismic forces. The lateral forces used for design of the members shall be applied at the center of mass of each level and shall be proportional to the distribution obtained from a modal analysis for the fundamental mode of response in the direction under consideration.

A5.2.9 Detailed evaluation. Sec. A5.2.9.1 and Sec. A5.2.9.2 need not be satisfied if the effective yield strength exceeds the product of the system overstrength factor as given in Table 4.3-1 and the seismic base shear determined in Sec. 5.2.1, modified to use the effective fundamental period T_e in place of T for the determination of C_s .

A5.2.9.1 Required member force and deformation. For each nonlinear static analysis the design response parameters, including the individual member forces, Q_{Ei} , and member deformations, γ_i , shall be taken as the values obtained from the analysis at the step at which the target displacement is reached.

A5.2.9.2 Member. The adequacy of individual members and their connections to withstand the member forces, Q_{Ei} , and member deformations, γ_i , shall be evaluated based on laboratory test data for similar components. The effects of gravity and other loads on member deformation capacity shall be considered in these evaluations. The deformation of a member supporting gravity loads shall not exceed

(i) two-thirds of the deformation that results in loss of ability to support gravity loads, and (ii) two-thirds of the deformation at which the member strength has deteriorated to less than the 70 percent of the peak strength of the component model. The deformation of a member not required for gravity load support shall not exceed two-thirds of the value at which member strength has deteriorated to less than 70% of the peak strength of the component model. Alternatively, it shall be permissible to deem member deformation to be acceptable if the deformation does not exceed the value determined using the acceptance criteria for nonlinear procedures given in the *Prestandard and Commentary for the Seismic Rehabilitation of Buildings* (FEMA 356) for the Life Safety performance level.

Member forces shall be deemed acceptable if not in excess of expected capacities.

A5.2.10 Design review. An independent team composed of at least two members, consisting of registered design professionals in the appropriate disciplines and others, with experience in seismic analysis methods and the theory and application of nonlinear seismic analysis and structural behavior under earthquake loading, shall perform a review of the design of the seismic force resisting system and the supporting structural analyses. The design review shall include (i) review of any site-specific seismic criteria employed in the analysis including the development of site-specific spectra, and (ii) review of the determination of the target displacement and effective yield strength of the structure.

For those structures with effective yield strength less than the product of the system overstrength factor as given in Table 4.3-1 and the seismic base shear determined in Sec. 5.2.1, modified to use the effective fundamental period T_e in place of T for the determination of C_s , the design review shall further include, but need not be limited to, the following:

1. Review of acceptance criteria used to demonstrate the adequacy of structural elements and systems to withstand the calculated force and deformation demands, together with that laboratory and other data used to substantiate such criteria. Review of the acceptance criteria for nonlinear procedures given in the *Prestandard and Commentary for the Seismic Rehabilitation of Buildings* (FEMA 356) shall be at the discretion of the design review team.
2. Review of the final design of the entire structural system and all supporting analyses. The design review team shall issue a report that identifies, within the scope of the review, significant concerns and any departures from general conformance with the *Provisions*.

REFERENCES

ATC 40 (SSC, 1996) *Seismic Evaluation and Retrofit of Concrete Buildings*, SSC Report No. 96-01, Seismic Safety Commission, State of California, Sacramento, California. Developed by the Applied Technology Council, Redwood City, California.

FEMA 350 (FEMA, 2000a), *Recommended Seismic Design Criteria for New Steel Moment-Frame Buildings*, Federal Emergency Management Agency, Washington, D.C.

FEMA 356 (FEMA, 2000b), *Prestandard and Commentary for the Seismic Rehabilitation of Buildings*, Federal Emergency Management Agency, Washington, D.C.

HAZUS (NIBS, 1999), *HAZUS99 Technical Manual*, National Institute of Building Science, Washington, D.C. Developed by the Federal Emergency Management Agency through agreements with the National Institute of Building Sciences.

Chapter 6

ARCHITECTURAL, MECHANICAL, AND ELECTRICAL COMPONENT DESIGN REQUIREMENTS

6.1 GENERAL

6.1.1 Scope. This chapter establishes minimum design criteria for nonstructural components that are permanently attached to structures and for their supports and attachments.

Exception: The following components are exempt from the requirements of this chapter.

1. Architectural components in Seismic Design Category B, other than parapets supported by bearing walls or shear walls, where the component importance factor, I_p , is equal to 1.0.
2. Mechanical and electrical components in Seismic Design Category B.
3. Mechanical and electrical components in Seismic Design Category C where the importance factor, I_p , is equal to 1.0.
4. Mechanical and electrical components in Seismic Design Category D, E, or F where the component importance factor, I_p , is equal to 1.0 and both of the following conditions apply:
 - a. flexible connections between the components and associated ductwork, piping, and conduit are provided, and
 - b. components are mounted at 4 ft (1.22 m) or less above a floor level and weigh 400 lb (1780 N) or less.
5. Mechanical and electrical components in Seismic Design Category C, D, E, or F where the component importance factor, I_p , is equal to 1.0 and both the following conditions apply:
 - a. flexible connections between the components and associated ductwork, piping, and conduit are provided, and
 - b. the components weigh 20 lb (95 N) or less or, for distribution systems, weigh 5 lb/ft (7 N/m) or less.

Design criteria for storage racks, storage tanks, and nonbuilding structures that are supported by other structures are provided in Chapter 14.

Where the individual weight of supported components and nonbuilding structures with periods greater than 0.06 seconds exceeds 25 percent of the total seismic weight W , the structure shall be designed considering interaction effects between the structure and the supported components.

Testing shall be permitted to be used in lieu of analysis methods outlined in this chapter to determine the seismic capacity of components and their supports and attachments. Thus, adoption of a nationally recognized standard, such as AC-156, is acceptable so long as the seismic capacities equal or exceed the demands determined in accordance with Sec. 6.2.

6.1.2 References

6.1.2.1 Use of Standards. Where a reference standard provides a basis for the earthquake-resistant design of a particular type of system or component, that standard may be used, subject to the following conditions:

1. The design earthquake forces shall not be less than those determined in accordance with Sec. 6.2.6.
2. Each component's seismic interactions with all other connected components and with the supporting structure shall be accounted for in the design. The component shall accommodate drifts,

deflections, and relative displacements determined in accordance with the applicable sections of the *Provisions*

6.1.2.2 Adopted References. The following references are adopted and are to be considered part of these *Provisions* to the extent referred to in this chapter:

- ASME A17.1 *Safety Code For Elevators And Escalators*, American Society of Mechanical Engineers, 1996.
- ASME B31.1 *Power Piping*, American Society of Mechanical Engineers, 2001.
- ASME B31.3 *Process Piping*, American Society of Mechanical Engineers, 2002.
- ASME B31.4 *Liquid Transportation Systems for Hydrocarbons, Liquid Petroleum Gas, Anhydrous Ammonia, and Alcohols*, American Society of Mechanical Engineers, 2002.
- ASME B31.5 *Refrigeration Piping*, American Society of Mechanical Engineers, 2001.
- ASME B31.8 *Gas Transmission and Distribution Piping Systems*, American Society of Mechanical Engineers, 1995.
- ASME B31.9 *Building Services Piping*, American Society of Mechanical Engineers, 1996.
- ASME B31.11 *Slurry Transportation Piping Systems*, American Society of Mechanical Engineers, 1989 (reaffirmed, 1998).
- ASME BPV *Boiler and Pressure Vessel Code*, American Society of Mechanical Engineers, including addenda through 2002.
- IEEE-344 *Recommended Practice for Seismic Qualification of Class I E Equipment for Nuclear Power Generating Stations*, Institute of Electrical and Electronic Engineers, 1987.
- NFPA-13 *Standard for the Installation of Sprinkler Systems*, National Fire Protection Association, 2000, including TIA 02-1 (NFPA 13) (SC 03-7-8 / Log No. 748).

6.1.2.3 Other references. The following references are developed within the industry and represent acceptable procedures for design and construction:

- AAMA 501.6 *Recommended Dynamic Test Method for Determining the Seismic Drift Causing Glass Fallout from a Wall System*, American Architectural Manufacturers Association, 2001.
- AC-156 *Acceptance Criteria for Seismic Qualification Testing of Nonstructural Components (AC 156)*, International Conference of Building Officials Evaluation Service, 2000.
- ASHRAE *Handbook, "Seismic Restraint Design,"* American Society of Heating, Ventilating, and Air Conditioning, 1999.
- CISCA 0-2 *Recommendations for Direct-Hung Acoustical Tile and Lay-in Panel Ceilings, Seismic Zones 0-2*, Ceilings and Interior Systems Construction Association, 1991.
- CISCA 3-4 *Recommendations for Direct-Hung Acoustical Tile and Lay-in Panel Ceilings, Seismic Zones 3-4*, Ceilings and Interior Systems Construction Association, 1991.
- SMACNA 95 *HVAC Duct Construction Standards, Metal and Flexible*, Sheet Metal and Air Conditioning Contractors National Association, 1995.
- SMACNA 80 *Rectangular Industrial Duct Construction Standards*, Sheet Metal and Air Conditioning Contractors National Association, 1980.
- SMACNA 98 *Seismic Restraint Manual Guidelines for Mechanical Systems*, Sheet Metal and Air Conditioning Contractors National Association, 1991, including Appendix B, 1998.

6.1.3 Definitions

Appendage: An architectural component such as a canopy, marquee, ornamental balcony, or statuary.

Attachments: Means by which components and their supports are secured and connected to the seismic-force-resisting system of the structure. Such attachments include anchor bolts, welded connections, and mechanical fasteners.

Base: See Sec. 4.1.3.

Component: See Sec. 1.1.4.

Construction documents: See Sec. 2.1.3.

Deformability: The ratio of the ultimate deformation to the limit deformation.

Enclosure: An interior space surrounded by walls.

Flexible component: Component, including its attachments, having a fundamental period greater than 0.06 sec.

Glazed curtain wall: A nonbearing wall that extends beyond the edges of the building floor slabs and includes a glazing material installed in the curtain wall framing.

Glazed partition: A partition that includes a glazing material installed in its framing.

Glazed storefront: A nonbearing wall that is installed between floor slabs, typically including entrances, and includes a glazing material installed in the storefront framing.

Grade plane: A reference plane representing the average of the finished ground level adjoining the structure at the exterior walls. Where the finished ground level slopes away from the exterior walls, the reference plane shall be established by the lowest points within the area between the buildings and the lot line or, where the lot line is more than 6 ft (1829 mm) from the structure between the structure and a point 6 ft (1829 mm) from the structure.

Hazardous material: See Sec. 1.1.4.

High deformability element: An element whose deformability is not less than 3.5 when subjected to four fully reversed cycles at the limit deformation.

Limit deformation: Two times the initial deformation that occurs at a load equal to 40 percent of the maximum strength.

Limited deformability element: An element that is neither a low deformability nor a high deformability element.

Low deformability element: An element whose deformability is 1.5 or less.

Nonbearing wall: An exterior or interior wall that does not provide support for vertical loads other than its own weight or as permitted by the building code administered by the authority having jurisdiction.

Nonbuilding structure: See Sec. 14.1.3.

Nonstructural wall: All walls other than bearing walls or shear walls.

Owner: See Sec. 1.1.4.

Partition: See Sec. 5.1.2.

Registered design professional: See Sec. 2.1.3.

Rigid component: Component, including its attachments, having a fundamental period less than or equal to 0.06 sec.

Seismic Design Category: See Sec. 1.1.4.

Seismic Use Group: See Sec. 1.1.4.

Special inspector: See Sec. 2.1.3.

Structure: See Sec. 1.1.4.

Supports: Those structural members, assemblies of members, or manufactured elements, including braces, frames, legs, lugs, snuggers, hangers, saddles, or struts, that transmit loads between the nonstructural components and the structure.

Ultimate deformation: The deformation at which failure occurs and which shall be deemed to occur if sustainable load reduces to 80 percent or less of the maximum strength.

Utility or service interface: The connection of the structure's mechanical and electrical distribution systems to the utility or service company's distribution system.

6.1.4 Notation

A_x	The torsional amplification factor determined using Eq. 5.2-13
a_i	Acceleration at Level i obtained by modal analysis.
a_p	The component amplification factor selected, as appropriate, from Table 6.3-1 or 6.4-1.
b_p	The width of the rectangular glass.
c_1	The clearance (gap) between vertical glass edges and the frame.
c_2	The clearance (gap) between horizontal glass edges and the frame.
D_{clear}	The relative horizontal (drift) displacement, measured over the height of the glass panel under consideration, which causes initial glass-to-frame contact. For rectangular glass panels within a rectangular wall frame, D_{clear} is given by Eq. 6.3-2.
D_p	Relative seismic displacement that the component must be designed to accommodate as defined in Sec. 6.2.7.
F_p	The seismic design force applicable to a particular nonstructural component.
g	Acceleration due to gravity.
h	The average roof height of structure above the base.
h_p	The height of the rectangular glass.
h_{sx}	Story height used in the definition of the allowable drift, Δ_a , in Table 4.5-1. Note that Δ_a/h_{sx} is the allowable drift index.
I_p	The component importance factor as prescribed in Sec. 6.2.2.
K_p	The stiffness of the system comprising the component and its supports and attachments, determined in terms of load per unit deflection at the center of gravity of the component.
Q_E	The effect of horizontal seismic forces. See Sec. 4.1.4.
R	Response modification coefficient. See Sec. 4.1.4.
R_p	The component response modification factor selected, as appropriate, from Table 6.3-1 or 6.4-1.
S_{DI}	The design, 5-percent-damped, spectral response acceleration parameter at a period of 1 second as defined in Sec. 3.3.3.

S_{DS}	The short period spectral acceleration parameter, determined in Sec. 3.3.3.
T_p	The fundamental period of a component (including its supports and attachments) as defined in Sec. 6.4.1.
W_p	Operating weight of a nonstructural component.
X	Height above the base of the upper support attachment (at level x).
Y	Height above the base of lower support attachment (at level y).
z	The height above the base of the point of attachment of the component, but z shall not be taken less than 0 and the value of z/h need not exceed 1.0.
Δ_{aA}	Allowable story drift for structure A, as defined in Table 4.5-1.
Δ_{aB}	Allowable story drift for structure B, as defined in Table 4.5-1.
Δ_{fallout}	The relative seismic displacement (drift) at which glass fallout from the curtain wall, storefront or partition occurs.
δ_{xA}	Deflection at level x of structure A, determined in accordance with Sec. 5.2.6, 5.3.5, or 5.4.3.
δ_{yA}	Deflection at level y of structure A, determined in accordance with Sec. 5.2.6, 5.3.5, or 5.4.3.
δ_{yB}	Deflection at level y of structure B, determined in accordance with Sec. 5.2.6, 5.3.5, or 5.4.3.
ρ	The redundancy factor as defined in Sec. 4.3.3.

6.2 GENERAL DESIGN REQUIREMENTS

Nonstructural components shall satisfy the requirements of this section. In addition to these general requirements, the requirements indicated in Table 6.2-1 shall apply.

Table 6.2-1 Additional Requirements for Nonstructural Components

Component Type	<i>Provisions Reference</i>	
	Quality Assurance	Design
Architectural components, including their supports and attachments	2.3.9	6.3
Mechanical and electrical components, including their supports and attachments	2.3.10 2.4.5	6.4

6.2.1 Seismic Design Category. For the purposes of this chapter, components shall be assigned to the same Seismic Design Category as the structure that they occupy or to which they are attached.

6.2.2 Component importance factor. All components shall be assigned a component importance factor as indicated in this section. The component importance factor, I_p , shall be taken as 1.5 if any of the following conditions apply:

1. The component is required to function after an earthquake,
2. The component contains hazardous materials, or
3. The component is in or attached to a Seismic Use Group III structure and it is needed for continued operation of the facility or its failure could impair the continued operation of the facility.

All other components shall be assigned a component importance factor, I_p , equal to 1.0.

6.2.3 Consequential damage. The functional and physical interrelationship of components and their effect on each other shall be considered so that the failure of an essential or nonessential architectural, mechanical, or electrical component shall not cause the failure of an essential architectural, mechanical, or electrical component.

6.2.4 Flexibility. The design and evaluation of components, supports, and attachments shall consider their flexibility as well as their strength.

6.2.5 Component force transfer. Components shall be attached such that the component forces are transferred to the structure. Component attachments that are intended to resist seismic forces shall be bolted, welded, or otherwise positively fastened without consideration of frictional resistance produced by the effects of gravity. A continuous load path of sufficient strength and stiffness between the component and the supporting structure shall be verified. Local elements of the supporting structure shall be designed for the component forces where such forces control the design of the elements or their connections. In this instance, the component forces shall be those determined in Section 6.2.6, except that modifications to F_p and R_p due to anchorage conditions need not be considered. The design documents shall include sufficient information concerning the attachments to verify compliance with the requirements of these Provisions.

6.2.6 Seismic forces. The seismic design force, F_p , applied in the horizontal direction shall be centered at the component's center of gravity and distributed relative to the component's mass distribution and shall be determined in accordance with Eq. 6.2-1 as follows:

$$F_p = \frac{0.4a_p S_{DS} W_p}{R_p / I_p} \left(1 + 2 \frac{z}{h} \right) \quad (6.2-1)$$

Exception: If the component period, T_p , is greater than T_{flx} where $T_{flx} = (1 + 0.25 z/h) S_{D1}/S_{DS}$, the value of F_p may be reduced by the ratio of T_{flx}/T_p .

In lieu of the forces determined in accordance with Eq. 6.2-1, accelerations at any level may be determined by the response spectrum procedure of Sec. 5.3 with R equal to 1.0, in which case seismic forces shall be determined in accordance with Eq. 6.2-2 as follows:

$$F_p = A_x \frac{a_i a_p W_p}{R_p / I_p} \quad (6.2-2)$$

F_p is not required to be taken as greater than:

$$F_p = 1.6 S_{DS} I_p W_p \quad (6.2-3)$$

Exception: If the component period, T_p , is greater than T_{flx} where $T_{flx} = (1 + 0.25 z/h) S_{D1}/S_{DS}$, the upper limit value of F_p may be reduced by the ratio of T_{flx}/T_p .

and F_p shall not be taken as less than:

$$F_p = 0.3 S_{DS} I_p W_p \quad (6.2-4)$$

The force F_p shall be independently applied in each of two orthogonal horizontal directions in combination with service loads. In addition, the nonstructural component shall be designed for a concurrent vertical force $\pm 0.2 S_{DS} W_p$. The reliability/redundancy factor, ρ , and the overstrength factor Ω_o are not applicable.

Where wind loads on nonstructural exterior walls or building code horizontal loads on interior partitions exceed F_p , such loads shall govern the strength design, but the detailing requirements and limitations prescribed in this chapter shall apply.

6.2.6.1 Allowable Stress Design. Where an adopted reference provides a basis for the earthquake-resistant design of a particular type of system or component, and the same reference defines acceptance

criteria in terms of allowable stresses rather than strengths, that reference shall be permitted to be used. The allowable stress load combination shall consider dead, live, operating, and earthquake loads. The earthquake loads determined in accordance with the *Provisions* shall be multiplied by a factor of 0.7. The allowable stress design load combinations of ASCE 7 need not be used. The component or system shall also accommodate the relative displacements specified in Section 6.2.7.

6.2.6.2 Seismic Design Force. The seismic design force, F_p , shall be centered at the component's center of gravity and distributed relative to the component's mass distribution and shall be determined in accordance with Eq. 6.2-1.

6.2.7 Seismic relative displacements. The relative seismic displacements, D_p , for use in component design shall be determined in accordance with Eq. 6.2-5 as follows:

$$D_p = \delta_{xA} - \delta_{yA} \quad (6.2-5)$$

D_p is not required to be taken greater than:

$$D_p = (X - Y) \frac{\Delta_{aA}}{h_{sx}} \quad (6.2-6)$$

For two connection points on separate structures, A and B, or separate structural systems, one at level x and the other at level y , D_p shall be determined in accordance with Eq. 6.2-7 as follows:

$$D_p = |\delta_{xA}| + |\delta_{yB}| \quad (6.2-7)$$

D_p is not required to be taken as greater than:

$$D_p = \frac{X \Delta_{aA}}{h_{sx}} + \frac{Y \Delta_{aB}}{h_{sx}} \quad (6.2-8)$$

The effects of relative seismic displacement shall be considered in combination with displacement caused by other loads as appropriate.

6.2.8 Component anchorage. Components shall be anchored in accordance with the requirements of this section and the anchorage shall satisfy the requirements for the parent material as set forth elsewhere in these *Provisions*.

6.2.8.1 Design forces. The forces in the connected part shall be determined based on the prescribed forces for the component specified in Sec. 6.2.6. The value of R_p used in Sec. 6.2.6 to determine the forces in the connected part shall not exceed 1.5 unless:

- a. The component anchorage is designed to be governed by the strength of a ductile steel element, or
- b. The design of anchors in concrete used for the component anchorage is based on Sec. 9.6.4.4.3 whereby post-installed anchors shall be pre-qualified for seismic applications per ACI 355.2-01.

6.2.8.2 Anchors in concrete or masonry. Anchors embedded in concrete or masonry shall be proportioned to carry the least of the following:

1. The design strength of the connected part,
2. 1.3 times the force in the connected part due to the prescribed forces, and
3. The maximum force that can be transferred to the connected part by the component structural system.

6.2.8.3 Installation conditions. Determination of forces in anchors shall take into account the expected conditions of installation including eccentricities and prying effects.

6.2.8.4 Multiple anchors. Determination of force distribution of multiple anchors at one location shall take into account the stiffness and ductility of the connected system and its ability to redistribute loads to other anchors in the group. Designs of anchorage in concrete in accordance with Sec. 9.6 shall be considered to satisfy this requirement.

6.2.8.5 Power actuated fasteners. Power actuated fasteners shall not be used for tension load applications in Seismic Design Category D, E, or F unless approved for such loading.

6.2.9 Construction documents. Where design of nonstructural components or their supports and attachments is required by these Provisions (as indicated in Table 6.2-1), such design shall be shown in construction documents prepared by a registered design professional for use by the owner, building officials, contractors, and inspectors. Such documents shall include a quality assurance plan as required by Sec. 2.2.

6.3 ARCHITECTURAL COMPONENTS

Architectural components, and their supports and attachments, shall satisfy the requirements of this section. Appropriate coefficients shall be selected from Table 6.3-1.

Exception: Components supported by chains or otherwise suspended from the structure are not required to satisfy the seismic force and relative displacement requirements provided they meet all of the following criteria:

1. The design load for such items shall be equal to 1.4 times the operating weight acting down with a simultaneous horizontal load equal to 1.4 times the operating weight. The horizontal load shall be applied in the direction that results in the most critical loading for design.
2. Seismic interaction effects shall be considered in accordance with Sec.6.2.3.
3. The connection to the structure shall allow a 360-degree range of horizontal motion.

Table 6.3-1 Coefficients for Architectural Components

Architectural Component or Element	a_p^a	R_p
Interior nonstructural walls and partitions ^b		
Plain masonry walls	1.0	1.5
All other walls and partitions	1.0	2.5
Cantilever Elements, unbraced or braced (to structural frame) below their centers of mass	2.5	2.5
Parapets and cantilevered interior nonstructural walls	2.5	2.5
Chimneys and stacks where laterally supported by structures		
Cantilever elements, braced (to structural frame) above their centers of mass		
Parapets	1.0	2.5
Chimneys and stacks	1.0	2.5
Exterior nonstructural walls ^b	1.0	2.5
Exterior nonstructural wall elements and connections ^b		
Wall element	1.0	2.5
Body of wall-panel connections	1.0	2.5
Fasteners of the connecting system	1.25	1.0
Veneer		
High deformability elements and attachments	1.0	2.5
Low deformability elements and attachments	1.0	1.5
Penthouses (except where framed by an extension of the building frame)	2.5	3.5

Ceilings All	1.0	2.5
Cabinets Storage cabinets and laboratory equipment	1.0	2.5
Access floors Special access floors All other	1.0 1.0	2.5 1.5
Appendages and ornamentation	2.5	2.5
Signs and billboards	2.5	2.5
Other rigid components High deformability elements and attachments Limited deformability elements and attachments Low deformability elements and attachments	1.0 1.0 1.0	3.5 2.5 1.5
Other flexible components High deformability elements and attachments Limited deformability elements and attachments Low deformability elements and attachments	2.5 2.5 2.5	3.5 2.5 1.5
^a A lower value for a_p is permitted where justified by detailed dynamic analysis. The value for a_p shall not be less than 1.0. The value of a_p equal to 1.0 is for rigid components and rigidly attached components. The value of a_p equal to 2.5 is for flexible components and flexibly attached components. ^b Where flexible diaphragms provide lateral support for concrete or masonry walls or partitions, the design forces for anchorage to the diaphragm shall be as specified in Sec. 4.6.2.1.		

6.3.1 Forces and displacements. All architectural components, and their supports and attachments, shall be designed for the seismic forces defined in Sec. 6.2.6.

Architectural components that could pose a life-safety hazard shall be designed to accommodate the seismic relative displacements defined in Sec. 6.2.7. Architectural components shall be designed considering vertical deflection due to joint rotation of horizontally cantilevered structural members.

6.3.2 Exterior nonstructural wall elements and connections. Exterior nonstructural wall panels or elements that are attached to or enclose the structure shall be designed to accommodate the seismic relative displacements defined in Sec. 6.2.7 and movements due to temperature changes. Such elements shall be supported by means of positive and direct structural supports or by mechanical connections and fasteners in accordance with the following requirements:

1. Connections and panel joints shall allow for a relative movement between stories of not less than the calculated story drift D_p or 1/2 in. (13 mm), whichever is greater.
2. Connections to permit movement in the plane of the panel for story drift shall be sliding connections using slotted or oversized holes, connections that permit movements by bending of steel, or other connections that provide equivalent sliding or ductile capacity.
3. Bodies of connectors shall have sufficient deformability and rotation capacity to preclude fracture of the concrete or low deformation failures at or near welds.
4. All fasteners in the connecting system such as bolts, inserts, welds, and dowels and the body of the connectors shall be designed for the seismic force F_p determined by Eq. 6.2-3, using values of a_p and R_p taken from Table 6.3-1, applied at the center of mass of the panel.
5. Where anchorage is achieved using flat straps embedded in concrete or masonry, such straps shall be attached to or hooked around reinforcing steel or otherwise terminated so as to effectively transfer forces to the reinforcing steel.

Glass in glazed curtain walls and storefronts shall be designed and installed in accordance with Sec. 6.3.7.

6.3.3 Out-of-plane bending. Transverse or out-of-plane bending or deformation of a component or system that is subjected to forces as determined in Sec. 6.2.6 shall not exceed the deflection capacity of the component or system.

6.3.4 Suspended ceilings. Suspended ceilings shall satisfy the requirements of this section.

6.3.4.1 Seismic forces. The weight of the ceiling, W_p , shall include the ceiling grid and panels; light fixtures if attached to, clipped to, or laterally supported by the ceiling grid; and other components which are laterally supported by the ceiling. W_p shall not be taken as less than 4 psf (0.2 kN/m²).

The seismic force, F_p , shall be transmitted through the ceiling attachments to the building structural elements or the ceiling-structure boundary.

6.3.4.2 Industry standard construction. Unless designed in accordance with Sec. 6.3.4.3, suspended ceilings shall be designed and constructed in accordance with this section.

6.3.4.2.1 Seismic Design Category C. Suspended ceilings in Seismic Design Category C shall be designed and installed in accordance with CISCA 0-2, except that seismic forces shall be determined in accordance with Sec. 6.2.6 and 6.3.4.1.

Sprinkler heads and other penetrations in Seismic Design Category C shall have a minimum clearance of 1/4 in. (6 mm) on all sides.

6.3.4.2.2 Seismic Design Categories D, E, and F. Suspended ceilings in Seismic Design Category D, E, or F shall be designed and installed in accordance with CISCA 3-4 and the requirements of this section.

1. A heavy-duty T-bar grid system shall be used.
2. The width of the perimeter supporting closure angle shall not be less than 2.0 in. (50 mm). In each orthogonal horizontal direction, one end of the ceiling grid shall be attached to the closure angle. The other end in each horizontal direction shall have a 3/4 in. (19 mm) clearance from the wall and shall rest upon and be free to slide on a closure angle.
3. For ceiling areas exceeding 1000 ft² (93m²), horizontal restraint of the ceiling to the structural system shall be provided by means of splay wires. The tributary areas of the horizontal restraints shall be approximately equal.

Exception: Rigid braces are permitted to be used instead of diagonal splay wires. Braces and the attachments to the structural system above shall be adequate to limit relative lateral deflections at the point of attachment to the ceiling grid to less than 1/4 in. (6 mm) when subjected to the loads prescribed in Sec. 6.2.6.

4. For ceiling areas exceeding 2500 ft² (230 m²), a seismic separation joint or full height partition that breaks the ceiling into areas not exceeding 2500 ft² shall be provided unless structural analyses of the ceiling bracing system for the prescribed seismic forces demonstrate that ceiling system penetrations and closure angles provide sufficient clearance to accommodate the additional movement. Each area shall be provided with closure angles in accordance with Item 2 and horizontal restraints or bracing in accordance with Item 3.
5. Except where rigid braces are used to limit lateral deflections, sprinkler heads and other penetrations shall have a 2 in. (50 mm) oversized ring, sleeve, or adapter through the ceiling tile to allow for free movement of at least 1 in. (25 mm) in all horizontal directions. Alternatively, a swing joint that can accommodate 1 in. (25 mm) of ceiling movement in all horizontal directions is permitted to be provided at the top of the sprinkler head extension.
6. Changes in ceiling elevation shall be provided with positive bracing.

7. Cable trays and electrical conduits shall be supported independently of the ceiling.
8. Suspended ceilings shall be subject to the special inspection requirements of Sec. 2.3.9 of these *Provisions*.

6.3.4.3 Integral construction. As an alternative to providing large clearances around sprinkler system penetrations through ceiling systems, the sprinkler system and ceiling grid are permitted to be designed and tied together as an integral unit. Such a design shall consider the mass and flexibility of all elements involved, including: ceiling system, sprinkler system, light fixtures, and mechanical (HVAC) appurtenances. Such design shall be performed by a registered design professional.

6.3.5 Access floors

6.3.5.1 General. Access floors shall satisfy the requirements of this section. The weight of the access floor, W_p , shall include the weight of the floor system, 100 percent of the weight of all equipment fastened to the floor, and 25 percent of the weight of all equipment supported by, but not fastened to the floor. The seismic force, F_p , shall be transmitted from the top surface of the access floor to the supporting structure.

Overturning effects of equipment fastened to the access floor panels also shall be considered. The ability of “slip on” heads for pedestals shall be evaluated for suitability to transfer overturning effects of equipment.

Where checking individual pedestals for overturning effects, the maximum concurrent axial load shall not exceed the portion of W_p assigned to the pedestal under consideration.

6.3.5.2 Special access floors. Access floors shall be considered to be “special access floors” if they are designed in accordance with the following considerations:

1. Connections transmitting seismic loads consist of mechanical fasteners, anchors complying with the requirements of Sec.9.6, welding, or bearing. Design load capacities comply with recognized design codes and/or certified test results.
2. Seismic loads are not transmitted by power actuated fasteners, adhesives, or by friction produced solely by the effects of gravity.
3. The bracing system shall be designed considering the destabilizing effects of individual members buckling in compression.
4. Bracing and pedestals are of structural or mechanical shape produced to ASTM specifications that specify minimum mechanical properties. Electrical tubing shall not be used.
5. Floor stringers that are designed to carry axial seismic loads and are mechanically fastened to the supporting pedestals are used.

6.3.6 Partitions. Partitions that are tied to the ceiling and all partitions greater than 6 ft (1.8 m) in height shall be laterally braced to the building structure. Such bracing shall be independent of any ceiling splay bracing. Bracing shall be spaced to limit horizontal deflection at the partition head to be comparable with ceiling deflection requirements as determined in Sec. 6.3.4 for suspended ceilings and Sec. 6.3.1 for other systems.

Glass in glazed partitions shall be designed and installed in accordance with Sec. 6.3.7.

6.3.7 General. Glass in glazed curtain walls, glazed storefronts and glazed partitions shall meet the relative displacement requirement of Eq. 6.3-1:

$$\Delta_{\text{fallout}} \geq 1.25 I D_p \text{ or } 0.5 \text{ in. (13mm), whichever is greater.} \tag{6.3-1}$$

D_p , the relative seismic displacement that the glazed curtain walls, glazed storefronts or glazed partitions component must be designed to accommodate (Eq. 6.2-5) shall be determined over the height of the

glass component under consideration.

Exceptions:

1. Glass with sufficient clearances from its frame such that physical contact between the glass and frame will not occur at the design drift, as demonstrated by Eq. 6.3-2, shall be exempted from the provisions of Eq. 6.3-1:

$$D_{clear} \geq 1.25 D_p \tag{6.3-2}$$

Where:

$$D_{clear} = 2c_1 \left(1 + \frac{h_p c_2}{b_p c_1} \right)$$

2. Fully tempered monolithic glass in Seismic Use Groups I and II located no more than 10 ft (3 m) above a walking surface shall be exempted from the provisions of Eq. 6.3-1.
3. Annealed or heat-strengthened laminated glass in single thickness with interlayer no less than 0.030 in. (0.76 mm) that is captured mechanically in a wall system glazing pocket, and whose perimeter is secured to the frame by a wet glazed gunable curing elastomeric sealant perimeter bead of 1/2 in. (13 mm) minimum glass contact width, or other approved anchorage system, shall be exempted from the provisions of Eq. 6.3-1.

6.3.8 Seismic Drift Limits for Glass Components. $\Delta_{fallout}$, the drift causing glass fallout from the curtain wall, storefront or partition, shall be determined in accordance with AAMA 501.6, or by engineering analysis.

6.4 MECHANICAL AND ELECTRICAL COMPONENTS

Mechanical and electrical components, and their supports and attachments, shall satisfy the requirements of this section. Appropriate coefficients shall be selected from Table 6.4-1.

Exception: Light fixtures, lighted signs, and ceiling fans not connected to ducts or piping, that are supported by chains or otherwise suspended from the structure, are not required to satisfy the seismic force and relative displacement requirements provided they meet all of the following criteria:

1. The design load for such items shall be 1.4 times the operating weight acting down with a simultaneous horizontal load equal to 1.4 times the operating weight. The horizontal load shall be applied in the direction which results in the most critical loading for design.
2. Seismic interaction effects shall be considered in accordance with Sec. 6.2.3.
3. The connection to the structure shall allow a 360-degree range of horizontal motion.

As an alternative to the analysis methods outlined in this section, testing is an acceptable method to determine the seismic capacity of components, and their supports and attachments. Thus, adaptation of a nationally recognized standard is acceptable so long as the seismic capacities equal or exceed the demands determined in accordance with Sec. 6.2.6 and 6.2.7.

Table 6.4-1 Coefficients for Mechanical and Electrical Components

Mechanical or Electrical Component or Element ^b	a_p^a	R_p
General Mechanical		

Boilers and Furnaces	1.0	2.5
Pressure vessels on skirts and free-standing	2.5	2.5
Stacks	2.5	2.5
Cantilevered chimneys	2.5	2.5
Other	1.0	2.5
Manufacturing and Process Machinery		
General	1.0	2.5
Conveyors (non-personnel)	2.5	2.5
Piping Systems		
High deformability elements and attachments	1.0	3.5
Limited deformability elements and attachments	1.0	2.5
Low deformability elements and attachments	1.0	1.5
HVAC System Component		
Vibration isolated	2.5	2.5
Non-vibration isolated	1.0	2.5
Mounted in-line with ductwork	1.0	2.5
Other	1.0	2.5
Elevator Components	1.0	2.5
Escalator Components	1.0	2.5
Trussed Towers (free-standing or guyed)	2.5	2.5
General Electrical		
Distribution systems (bus ducts, conduit, cable tray)	2.5	5
Equipment	1.0	2.5
Lighting Fixtures	1.0	1.5
<p>^a A lower value for a_p is permitted where justified by detailed dynamic analysis. The value for a_p shall not be less than 1.0. The value of a_p equal to 1.0 is for rigid components and rigidly attached components. The value of a_p equal to 2.5 is for flexible components and flexibly attached components.</p> <p>^b Components mounted on vibration isolators shall have a bumper restraint or snubber in each horizontal direction. The design force shall be taken as $2F_p$ if the nominal clearance (air gap) between the equipment support frame and restraint is greater than 0.25 in. If the nominal clearance specified on the construction documents is not greater than 0.25 in., the design force may be taken as F_p.</p>		

Where design of mechanical and electrical components for seismic effects is required, consideration shall be given to the dynamic effects of the components, their contents, and where appropriate, their supports. In such cases, the interaction between the components and the supporting structures, including other mechanical and electrical components, shall also be considered.

Some complex equipment such as valve operators, turbines and generators, and pumps and motors are permitted to be functionally connected by mechanical links that are not capable of transferring the seismic loads or accommodating seismic relative displacements. Such items may require special design considerations such as a common rigid support or skid.

6.4.1 Component period. Where the dynamic response of a mechanical or electrical component (including its supports and attachments) can reasonably be approximated by a spring-and-mass single-degree-of-freedom system, the fundamental period of the component, T_p , may be determined using Eq. 6.4-1 as follows:

$$T_p = 2\pi \sqrt{\frac{W_p}{K_p g}} \quad (6.4-1)$$

Alternatively, the fundamental period of the component, T_p , may be determined from experimental test data or by a properly substantiated analysis.

6.4.2 Mechanical components. Mechanical components with I_p greater than 1.0 shall be designed for the seismic forces and relative displacements defined in Sec. 6.2.6 and 6.2.7 and shall satisfy the following additional requirements:

1. Provision shall be made to eliminate seismic impact for components vulnerable to impact, for components constructed of nonductile materials, and in cases where material ductility will be reduced due to service conditions (such as low temperature applications).
2. The possibility of loads imposed on components by attached utility or service lines, due to differential movement of support points on separate structures, shall be evaluated.
3. Where mechanical components contain a sufficient quantity of hazardous material to pose a danger if released and for boilers and pressure vessels not designed in accordance with ASME BPV, the design strength for seismic loads in combination with other service loads and appropriate environmental effects (such as corrosion) shall be based on the following material properties:
 - a. For mechanical components constructed with ductile materials (such as steel, aluminum, or copper), 90 percent of the minimum specified yield strength.
 - b. For threaded connections in components constructed with ductile materials, 70 percent of the minimum specified yield strength.
 - c. For mechanical components constructed with nonductile materials (such as plastic, cast iron, or ceramics), 25 percent of the minimum specified tensile strength.
 - d. For threaded connections in components constructed with nonductile materials, 20 percent of the minimum specified tensile strength.
4. Where piping or HVAC ductwork components are attached to structures that could displace relative to one another and for isolated structures where such components cross the isolation interface, the components shall be designed to accommodate the seismic relative displacements defined in Sec. 6.2.7.

6.4.3 Electrical components. Electrical components with I_p greater than 1.0 shall be designed for the seismic forces and relative displacements defined in Sec. 6.2.6 and 6.2.7 and shall satisfy the following additional requirements:

1. Provision shall be made to eliminate seismic impact between components.
2. Evaluate loads imposed on the components by attached utility or service lines which are also attached to separate structures.
3. Batteries on racks shall have wrap-around restraints to ensure that the batteries will not fall from the rack. Spacers shall be used between restraints and cells to prevent damage to cases. Racks shall be evaluated for sufficient lateral load capacity.
4. Internal coils of dry type transformers shall be positively attached to their supporting substructure within the transformer enclosure.
5. Electrical control panels, computer equipment, and other items with slide-out components shall have a latching mechanism to hold the components in place.
6. Electrical cabinet design shall comply with the applicable National Electrical Manufacturers Association (NEMA) standards. Cut-outs in the lower shear panel that do not appear to have been

made by the manufacturer and are judged to reduce significantly the strength of the cabinet shall be specifically evaluated.

7. The attachments for additional external items weighing more than 100 lb (445 N) shall be specifically evaluated if not provided by the manufacturer.
8. Where conduit, cable trays, or similar electrical distribution components are attached to structures that could displace relative to one another and for isolated structures where such components cross the isolation interface, the components shall be designed to accommodate the seismic relative displacements defined in Sec. 6.2.7.

6.4.4 Supports and attachments

Supports and attachments for mechanical and electrical components shall be designed for the seismic forces defined in Sec. 6.2.6 and shall satisfy the requirements found elsewhere in these *Provisions*, as appropriate, for the materials comprising the means of attachment.

Supports for components shall be designed to accommodate the seismic relative displacements between points of support as determined in accordance with Sec. 6.2.7. Supports for components may be forged or cast so as to form an integral part of the mechanical or electrical component. Attachments between the component and its supports, except where integral, shall be designed to accommodate both the forces and displacements determined in accordance with Sec. 6.2.6 and 6.2.7. Where I_p is greater than 1.0, the effect of load transfer on the component wall at the point of attachment shall be evaluated.

The following additional requirements shall apply:

1. Supports and attachments that transfer seismic loads shall be constructed of materials suitable for the application and shall be designed and constructed in accordance with a nationally recognized standard specification, such as those listed in Sec. 6.1.2.
2. Seismic supports shall be constructed so that support engagement is maintained.
3. Friction clips shall not be used for anchorage attachment.
4. Oversized plate washers extending to the component wall shall be used at bolted connections through the sheet metal base if the base is not reinforced with stiffeners or is not judged to be capable of transferring the required loads.
5. Where weak-axis bending of cold-formed steel supports is relied on for the seismic load path, such supports shall be specifically evaluated.
6. Components mounted on vibration isolators shall have a bumper restraint or snubber in each horizontal direction, and vertical restraints shall be provided where required to resist overturning. Isolator housings and restraints shall be constructed of ductile materials. (See additional design force requirements in Table 6.4-1.) A viscoelastic pad or similar material of appropriate thickness shall be used between the bumper and components to limit the impact load.
7. Expansion anchors shall not be used for non-vibration isolated mechanical equipment rated over 10 hp (7.45 kW).

Exception: Undercut expansion anchors are permitted.

8. The supports for electrical distribution components shall be designed for the seismic forces and relative displacements defined in Sec. 6.2.6 and 6.2.7 if any of the following conditions apply:
 - a. Supports are cantilevered up from the floor;
 - b. Supports include bracing to limit deflection;
 - c. Supports are constructed as rigid welded frames;
 - d. Attachments into concrete utilize non-expanding insets, powder driven fasteners, or cast iron

embedments; or

- e. Attachments utilize spot welds, plug welds, or minimum size welds as defined by AISC.

9. For boilers and pressure vessels, attachments to concrete shall be suitable for cyclic loads.

6.4.5 Utility and service lines. At the interface of adjacent structures or portions of the same structure that may move independently, utility lines shall be provided with adequate flexibility to accommodate the anticipated differential movement between the ground and the structure. Differential displacements shall be determined in accordance with Sec. 6.2.7.

The possible interruption of utility service shall be considered in relation to designated seismic systems in Seismic Use Group III, as defined in Sec. 1.2.1. Specific attention shall be given to the vulnerability of underground utilities and utility interfaces between the structure and the ground in all situations where the assigned Site Class is E or F and S_{DS} is greater than or equal to 0.4.

6.4.6 HVAC ductwork. Seismic restraints are not required for HVAC ducts with I_p equal to 1.0 if either of the following conditions is met for the full length of each duct run:

1. HVAC ducts are suspended from hangers, all hangers are 12 in. (305 mm) or less in length as measured from the point of attachment to the duct to the point of attachment on the supporting structure and the hangers are detailed to avoid significant bending of the hangers and their attachments; or
2. HVAC ducts have a cross-sectional area of less than 6 ft² (0.6 m²).

HVAC duct systems fabricated and installed in accordance with SMACNA 80, SMACNA 95, and SMACNA 98 shall be deemed to satisfy the seismic bracing requirements of these *Provisions*.

Components that are installed in-line with the duct system and have an operating weight greater than 75 lb (334 N), such as fans, heat exchangers, and humidifiers, shall be supported and laterally braced independently of the duct system and such braces shall be designed for the seismic forces defined in Sec. 6.2.6. Appurtenances, such as dampers, louvers, and diffusers, shall be positively attached with mechanical fasteners. Unbraced piping attached to in-line equipment shall be provided with adequate flexibility to accommodate differential displacements.

6.4.7 Piping systems. Piping systems shall satisfy the requirements of this section except that elevator system piping shall satisfy the requirements of Sec. 6.4.9.

6.4.7.1 Fire protection sprinkler systems. Fire protection sprinkler systems shall be designed and constructed in accordance with NFPA-13. Fire protection sprinkler systems in Seismic Design Category C designed and constructed in accordance with NFPA-13 shall be deemed to satisfy the seismic force and relative displacement requirements of these *Provisions*.

In Seismic Design Categories D, E and F, fire protection sprinkler systems designed and constructed in accordance with NFPA-13 shall meet the following additional criteria:

6.4.7.1.1 The spacing of longitudinal sway bracing and transverse sway bracing specified in NFPA 13 Section 9.3.5 shall be reduced by multiplying the maximum brace spacing permitted in NFPA 13 Section 9.3.5 by $0.8W_p / F_p$. The value of $0.8W_p / F_p$ shall not be taken as greater than 1.0.

6.4.7.2 Other piping systems. Where the seismic design forces and displacements specified in ASME B31.1, ASME B31.3, ASME B31.4, ASME B31.5, ASME B31.8, ASME B31.9, and ASME B31.11 are comparable to those determined using these *Provisions*, the use of these standards for seismic design of piping systems shall be permitted.

Exception: Piping systems with I_p greater than 1.0 shall not be designed using the simplified analysis procedures found in Sec. 919.4.1 (a) of ASME B31.9.

Piping systems with I_p greater than 1.0 also shall satisfy the following requirements:

1. Under design loads and displacements, piping shall not be permitted to impact other components.
2. Piping shall accommodate the effects of relative displacements that may occur between piping support points on the structure or the ground and other mechanical or electrical equipment or other piping.

Seismic supports for other piping shall be constructed so that support engagement is maintained, and attachments shall be designed in accordance with Sec. 6.2.8.

Seismic supports are not required for other piping systems where one of the following conditions is met:

1. Piping is supported by rod hangers, all hangers in the pipe run are 12 in. (305 mm) or less in length from the top of the pipe to the supporting structure, the hangers are detailed to avoid bending of the hangers and their attachments, and the pipe can accommodate the expected deflections; or
2. High deformability piping is used, provision is made to avoid impact with larger piping or mechanical components or to protect the piping in the event of such impact, and the following size requirements are satisfied:
 - a. In Seismic Design Category D, E, or F, where I_p is greater than 1.0, the nominal pipe size shall be 1 in. (25 mm) or less,
 - b. In Seismic Design Category C, where I_p is greater than 1.0, the nominal pipe size shall be 2 in. (51 mm) or less, and
 - c. In Seismic Design Category D, E, or F, where I_p is equal to 1.0, the nominal pipe size shall be 3 in. (76 mm) or less.

6.4.8 Boilers and pressure vessels. Boilers and pressure vessels designed in accordance with ASME BPV shall be deemed to satisfy the seismic force and relative displacement requirements of these *Provisions* provided that the forces and displacements defined in Sec. 6.2.6 and 6.2.7 are used in lieu of the seismic forces and displacements defined in ASME BPV. Supports and attachments for boilers and pressure vessels are still subject to the requirements of these *Provisions*.

6.4.9 Elevators. Elevators designed in accordance with the seismic provisions of ASME A17.1 shall be deemed to satisfy the requirements of this chapter except that they also shall satisfy the additional requirements of this section.

6.4.9.1 Elevators and hoistway structural systems. Elevators and hoistway structural systems shall be designed for the seismic forces and relative displacements defined in Sec. 6.2.6 and 6.2.7.

6.4.9.2 Elevator machinery and controller supports and attachments. Supports and attachments for elevator machinery and controllers shall be designed for the seismic forces and relative displacements defined in Sec. 6.2.6 and 6.2.7.

6.4.9.3 Seismic switches. Seismic switches shall be provided for all elevators that operate with a speed of 150 ft/min (46 m/min) or greater, including those which satisfy the requirements of ASME A17.1.

Seismic switches shall provide an electrical signal indicating that structural motions are of such a magnitude that the operation of elevators may be impaired. The seismic switch shall be located at or above the highest floor serviced by the elevator. The seismic switch shall have two horizontal perpendicular axes of sensitivity. Its trigger level shall be set to 30 percent of the acceleration of gravity in facilities where the loss of the use of an elevator is a life-safety issue.

Upon activation of the seismic switch, elevator operations shall comply with the provisions of ASME A17.1. The elevator may be used after the seismic switch has triggered provided that:

1. The elevator shall operate no faster than the service speed,
2. The elevator shall be operated remotely from top to bottom and back to top to verify that it is operable, and

3. The individual putting the elevator back in service shall ride the elevator from top to bottom and back to top to verify acceptable performance.

6.4.9.4 Retainer plates. Retainer plates are required at the top and bottom of the car and counterweight.

Appendix to Chapter 6

ALTERNATIVE PROVISIONS FOR THE DESIGN OF PIPING SYSTEMS

BACKGROUND: As currently written, the Provisions do not recognize discrete levels of performance that may be relevant to the seismic design of piping systems, particularly for essential facilities. This Appendix provides preliminary criteria for the establishment of such performance criteria and their use in the assessment and design of piping systems. The performance criteria, from least restrictive to most severe, are: position retention, leak tightness and operability. In particular, the interaction of systems and interface with the relevant piping design standards is addressed.

A6.1 DEFINITIONS

Leak Tightness: The condition of a piping system characterized by containment of contents, or maintenance of a vacuum, with no discernable leakage.

Operability: The condition of a piping system characterized by leak tightness as well as continued delivery, shutoff or throttle of pipe contents flow by means of unimpaired operation of equipment and components such as pumps, compressors and valves.

Position Retention: The condition of a piping system characterized by the absence of collapse or fall of any part of the system.

A6.2 DESIGN APPROACH

The seismic design of piping systems is determined on the basis of Seismic Design Category, I_p , and pipe size, as provided in Table A6.2-1. For each case in table A6.2-1, the procedure for seismic qualification is specified in Sec.A.6.5.

Where $I_p = 1.0$, the piping system is not criticalcritical and is required to maintain position retention.

Where $I_p = 1.5$, the piping system is critical and is required to exhibit leak tightness and may be required to maintain operability.

Table A6.2-1 Seismic Design Requirements

Seismic Design Category	$I_p = 1.0$		$I_p = 1.5$	
	Pipe Size \leq 4 inch (SI: 102 mm)	Pipe Size $>$ 4 inch (SI: 102 mm)	Pipe Size \leq 4 inch (SI: 102 mm)	Pipe Size $>$ 4 inch (SI: 102 mm)
B	Interactions (A6.5.2.1)	Interactions (A6.5.2.1)	Bracing (A6.5.2.2) Restraints (A6.5.2.3) Operability ^a (A6.5.2.4) Interactions (A6.5.2.1)	Bracing (A6.5.2.2) Restraints (A6.5.2.3) Operability ^a (A6.5.2.4) Interactions (A6.5.2.1)
C or D	Interactions (A6.5.2.1)	Interactions (A6.5.2.1)	Bracing (A6.5.2.2) Restraints (A6.5.2.3) Operability ^a (A6.5.2.4) Interactions (A6.5.4.2.1)	Analysis (A6.5.2.5) Restraints (A6.5.2.3) Operability ^a (A6.5.2.4) Interactions (A6.5.2.1)
E or F	Bracing (A6.5.2.2) Restraints (A6.5.2.3) Interactions (A6.5.2.1)	Bracing (A6.5.2.2) Restraints (A6.5.2.3) Operability ^a (A6.5.2.4) Interactions (A6.5.2.1)	Analysis (A6.5.2.5) Restraints (A6.5.2.3) Operability ^a (A6.5.2.4) Interactions (A6.5.2.1)	Analysis (A6.5.2.5) Restraints (A6.5.2.3) Operability ^a (A6.5.2.4) Interactions (A6.5.2.1)

^a Leak tightness is the default requirement. Operability applies only where specified by design.

A6.3 SYSTEM COEFFICIENTS

A6.3.1 Deformability. Piping systems shall be classified as either high-, limited-, or low-deformability systems.

All materials in high-deformability piping systems shall have an elongation at rupture of at least 10 percent at the operating temperature, and pipes and pipe components used in high-deformability systems shall be joined by welding or by bolted flanges.

Systems containing components with an elongation at rupture of less than 10 percent at the operating temperature, or having joints that rely only on friction, shall be classified as low-deformability systems.

Systems that are neither high- nor low-deformability systems shall be classified as limited deformability systems. Systems with threaded connections shall be classified as limited- or low-deformability systems.

A6.3.2 Seismic Coefficients. The seismic coefficients a_p and R_p are specified in Table 6.4.1 for high-, limited-, and low-deformability piping systems.

A6.4 SEISMIC DEMAND

A6.4.1 Seismic demand on a piping system consists of applied forces and relative displacements.

A6.4.2 Seismic forces shall be determined as specified in Sec. 6.2.6.

A6.4.3 Seismic relative displacements at points of attachments of pipe restraints to the structure shall be determined as specified in Sec. 6.2.7.

A6.5 SEISMIC QUALIFICATION

A6.5.1 Elevator system piping shall satisfy the provisions of Sec.6.4.9. ASME B31 pressure piping systems shall satisfy the provisions of the applicable ASME B31 code section. Fire sprinkler systems shall satisfy the provisions of Sec.A6.5.2.6.

A6.5.2 The seismic qualification of piping systems depends on the Design Approach selected in A6.2.

A6.5.2.1 Where interactions are specified they shall be evaluated in accordance with Sec.6.2.3.

A6.5.2.2 Where bracing is specified, the pipe must be seismically restrained. Lateral restraints shall be provided (a) to limit the bending stress in the pipe to yield at the operating temperature and (b) to limit the rotations at articulated joints within the manufacturer limits. Unlike analysis (Sec. A6.5.2.5), bracing does not require a detailed analysis of the piping system; the distance between seismic restraints may be established based on beam approximations of the pipe spans. The effect of seismic restrains on operating loads (thermal expansion and contraction, weight) shall be considered.

A6.5.2.3 Where restraints are specified, the pipe seismic restraints as well as their welds and anchorage attachment to the structure shall comply with the provisions of Chapters 8 to 12. Supports shall be constructed so that support engagement is maintained considering both lateral and vertical seismic forces.

A6.5.2.4 Where operability is specified, the equipment and components that must perform an active function that involves moving parts (such as pumps, compressors, fans and valve operators) shall comply with the requirements of Sec.2.4.5.

A6.5.2.5 Where analysis is specified, the piping system shall be analyzed by static or dynamic methods. The maximum calculated elastic stress due to the earthquake loads and concurrent weight and pressure shall be limited to $1.5S_Y$ (where S_Y is the minimum specified material yield stress at normal operating temperature) and the rotations at articulated joints shall be within the manufacturer limits. The analysis shall include the effects of stress intensification factors as determined in the ASME B31 pressure piping code, and corrosion effects.

A6.5.2.6 Fire protection sprinkler systems shall meet the following requirements:

A6.5.2.6.1 Fire protection sprinkler systems in Seismic Design Categories A, B and C designed and constructed in accordance with NFPA-13 shall be deemed to satisfy the seismic force and relative displacement requirements of these *Provisions*.

A6.5.2.6.2 In Seismic Design Categories D, E and F, fire protection sprinkler systems designed and constructed in accordance with NFPA 13 shall also meet the following additional criteria:

1. The spacing of longitudinal sway bracing and transverse sway bracing specified in NFPA 13 Sec. 9.3.5 shall be reduced by multiplying the maximum brace spacing permitted in NFPA 13 Sec. 9.3.5 by $0.8W_p / F_p$. The value of $0.8W_p / F_p$ shall not be taken as greater than 1.0.

This page is intentionally left blank.

Chapter 7

FOUNDATION DESIGN REQUIREMENTS

7.1 GENERAL

7.1.1 Scope. This chapter includes only those foundation requirements that are specifically related to seismic resistant construction. It assumes compliance with all other basic requirements which include, but are not limited to, requirements for the extent of the foundation investigation, fills to be present or to be placed in the area of the structure, slope stability, subsurface drainage, settlement control, and soil bearing and lateral soil pressure recommendations for loads acting without seismic forces.

7.1.2 References. The following document shall be used as specified in this chapter.

ACI 318 *Building Code Requirements for Structural Concrete*, American Concrete Institute, 2002.

AISC-Seismic *Seismic Provisions For Structural Steel Buildings*, American Institute of Steel Construction May 21, 2002

7.1.3 Definitions.

Basement: Any story below the lowest story above grade.

Component: See Sec. 1.1.4.

Design earthquake ground motion: See Sec. 1.1.4.

Design strength: See Sec. 4.1.3.

Longitudinal reinforcement ratio: Area of the longitudinal reinforcement divided by the cross-sectional area of the concrete.

Nominal strength: See Sec. 4.1.3.

Owner: See Sec. 1.1.4.

Pile: Deep foundation components including piers, caissons, and piles.

Pile cap: Foundation elements to which piles are connected, including grade beams and mats.

Reinforced concrete: See Sec. 9.1.3.

Required strength: See Sec. 4.1.3.

Seismic Design Category: See Sec. 1.1.4.

Seismic forces: See Sec. 1.1.4.

Site Class: See Sec. 3.1.3.

Structure: See Sec. 1.1.4.

Wall: See Sec. 4.1.3.

7.1.4 Notation

A_{ch} Cross sectional-area of a component measured to the outside of the special lateral reinforcement.

A_g Gross cross sectional-area of a component.

f'_c Specified compressive strength of concrete used in design.

f_{yh}	Specified yield stress of the special lateral reinforcement.
h_c	The core dimension of a component measured to the outside of the special lateral reinforcement.
P	Axial load on pile calculated in accordance with Sec. 4.2.2.
S_{DS}	See Sec. 3.1.4.
s	Spacing of transverse reinforcement measured along the length of an element.

7.2 GENERAL DESIGN REQUIREMENTS

The resisting capacities of the foundations, subjected to the load combinations prescribed elsewhere in these *Provisions*, shall meet the requirements of this chapter.

7.2.1 Foundation components. The strength and detailing of foundation components under seismic loading conditions, including foundation elements and attachments of the foundation elements to the superstructure, shall comply with the requirements of Chapters 8, 9, 10, 11, or 12, unless otherwise specified in this chapter. The strength of foundation components shall not be less than that required for load combinations that do not include seismic load effects.

7.2.2 Soil capacities. The capacity of the foundation soil in bearing or the capacity of the interface between pile, pier, or caisson and the soil shall be sufficient to support the structure with all prescribed loads, without seismic forces, taking due account of the settlement that the structure can withstand. For the load combinations including seismic load effects as specified in Sec. 4.2.2, the soil capacities must be sufficient to resist loads at acceptable strains considering both the short duration of loading and the dynamic properties of the soil.

7.2.3. Foundation load-deformation characteristics. Where permitted for the linear analysis procedures in Chapter 5, the load-deformation characteristics of the foundation-soil system (foundation stiffness) shall be modeled in accordance with the requirements of this section. The linear load-deformation behavior of foundations shall be represented by an equivalent linear stiffness using soil properties that are compatible with the soil strain levels associated with the design earthquake motion. The strain-compatible shear modulus, G , and the associated strain-compatible shear wave velocity, v_s , needed for the evaluation of equivalent linear stiffness shall be determined using the criteria in Sec. 5.6.2.1.1 or based on a site-specific study. Parametric variations of not less than 50% increase and decrease in stiffness shall be incorporated in dynamic analyses unless smaller variations can be justified based on field measurements of dynamic soil properties or direct measurements of dynamic foundation stiffness.

7.3 SEISMIC DESIGN CATEGORY B

Any construction meeting the requirements of Sec. 7.1 and 7.2 is permitted to be used for structures assigned to Seismic Design Category B.

7.4 SEISMIC DESIGN CATEGORY C

Foundations for structures assigned to Seismic Design Category C shall comply with Sec. 7.3 and the additional requirements of this section.

7.4.1 Investigation. An investigation shall be conducted and a written report shall be provided that shall include, in addition to the requirements of Sec. 7.1 and the evaluations required in Sec. 7.2.2, the results of an investigation to determine the potential hazards due to slope instability, liquefaction, differential settlement, and surface displacement due to faulting or lateral spreading, all as a result of earthquakes. The report shall contain recommendations for appropriate foundation designs or other measures to mitigate the effects of the above hazards. Where deemed appropriate by the authority having jurisdiction, a report is not required when prior evaluations of nearby sites with similar soil conditions provide sufficient direction relative to the proposed construction.

7.4.2 Pole-type structures. Construction employing posts or poles as columns embedded in earth or embedded in concrete footings in the earth are permitted to be used to resist both axial and lateral loads. The depth of embedment required for posts or poles to resist seismic forces shall be determined by means of the design criteria established in the foundation investigation report.

7.4.3 Foundation ties. Individual pile caps, drilled piers, or caissons shall be interconnected by ties. All ties shall be capable of carrying, in tension or compression, a force equal to the product of the larger pile cap or column load times S_{DS} divided by 10 unless it can be demonstrated that equivalent restraint can be provided by reinforced concrete beams within slabs on grade or reinforced concrete slabs on grade or confinement by competent rock, hard cohesive soils, very dense granular soils, or other approved means.

7.4.4 Special pile requirements. The following special requirements for piles, piers, or caissons are in addition to all other requirements in the code administered by the authority having jurisdiction.

All concrete piles and concrete filled pipe piles shall be connected to the pile cap by embedding the pile reinforcement in the pile cap for a distance equal to the development length as specified in ACI 318 as modified by Chapter 9 of these *Provisions*. The pile cap connection can be made by the use of field-placed dowel(s) anchored in the concrete pile. For deformed bars, the development length is the full development length for compression or tension, in the case of uplift, without reduction in length for excess area.

Ends of rectangular hoops, spirals, and ties shall be terminated with seismic hooks as defined in Sec. 21.1 of ACI 318 turned into the confined concrete core. The ends of circular spirals and hoops shall be terminated with 90-degree hooks turned into the confined concrete core.

For resistance to uplift forces, anchorage of steel pipe (or round HSS), concrete filled steel pipe, or H piles to the pile cap shall be made by means other than concrete bond to the bare steel section.

Exception: Anchorage of concrete filled steel pipe piles is permitted to be accomplished using deformed bars developed into the concrete portion of the pile.

Where a minimum length for reinforcement or the extent of closely spaced confinement reinforcement is specified at the top of the pile, provisions shall be made so that those specified lengths or extents are maintained after pile cut-off.

7.4.4.1 Uncased concrete piles. The longitudinal reinforcement ratio for uncased cast-in-place concrete drilled or augered piles, piers, or caissons shall not be less than 0.0025 throughout the largest region defined as follows: the top one-third of the pile length, the top 10 ft (3 m) below the ground, or the flexural length of the pile. The flexural length shall be taken as the length from the top of the pile to the lowest point where the calculated flexural demand exceeds 0.4 times the concrete section cracking moment. The longitudinal reinforcing shall extend beyond the flexural length of the pile by the tension development length. Longitudinal reinforcement shall consist of at least four bars and shall be confined with closed ties or equivalent spirals with a diameter of not less than 3/8 in. (9.5 mm) and spaced not more than 16 times the diameter of the smallest longitudinal bar. Within three pile diameters of the bottom of the pile cap, transverse confinement reinforcing shall be spaced not more than the lesser of eight times the diameter of the smallest longitudinal bar or 6 in. (150 mm).

7.4.4.2 Metal-cased concrete piles. Reinforcement requirements are the same as for uncased concrete piles.

Exception: Spiral welded metal casing of a thickness not less than No. 14 gauge may be considered to provide concrete confinement equivalent to the closed ties or equivalent spirals required in an uncased concrete pile, provided that the metal casing is adequately protected against possible deleterious action due to soil constituents, changing water levels, or other factors indicated by boring records of site conditions.

7.4.4.3 Concrete-filled pipe. The longitudinal reinforcement ratio at the top of the pile shall not be less than 0.01 and such reinforcement shall extend into the pile at least two times the length required for embedment into the pile cap.

7.4.4.4 Precast (non-prestressed) concrete piles. The longitudinal reinforcement ratio for precast concrete piles shall not be less than 0.01. Longitudinal reinforcement shall be full length and shall be confined with closed ties or equivalent spirals with a diameter of not less than 3/8 in. (9.5mm) and spaced not more than the lesser of 16 times the diameter of the smallest longitudinal bar or 8 in. (200 mm). Within three pile diameters of the bottom of the pile cap, transverse confinement reinforcing shall be spaced not more than the lesser of eight times the diameter of the smallest longitudinal bar or 6 in. (152 mm).

7.4.4.5 Precast-prestressed piles. Transverse reinforcement shall consist of circular hoops or spirals. For the upper 20 ft (6 m) of the pile, the volumetric ratio of transverse reinforcement shall not be less than the larger of 0.007 or that required by Eq. 7.4-1 as follows:

$$\rho_s = 0.12 \frac{f'_c}{f_{yh}} \quad (7.4-1)$$

Where:

ρ_s = volumetric ratio of transverse reinforcement (volume of transverse reinforcement divided by volume of enclosed core),

f'_c = specified compressive strength of concrete, psi (Mpa), and

f_{yh} = yield strength of transverse reinforcement, which shall not be taken greater than 85,000 psi (586 MPa).

Below the 20 ft (6 m) point, the amount of transverse reinforcement shall not be less than one-half that required by Eq. 7.4-1.

7.5 SEISMIC DESIGN CATEGORIES D, E, AND F

Foundations for structures assigned to Seismic Design Category D, E, or F shall comply with Sec. 7.4 and the additional requirements of this section. Concrete foundation components shall be designed and constructed in accordance with Sec. 21.8 of ACI 318, except as modified by the requirements of this section.

Exception: Detached one- and two-family dwellings of light-frame construction not exceeding two stories in height above grade need only comply with the requirements for Sec.7.4 and Sec. 7.5.3.

7.5.1 Investigation. In addition to requirements of Sec. 7.4.1, the investigation and report shall include the determination of lateral pressures on basement and retaining walls due to earthquake motions.

7.5.2 Liquefaction potential and soil strength loss. The geotechnical report shall describe the likelihood and potential consequences of liquefaction and soil strength loss (including estimates of differential settlement, lateral movement, lateral loads on foundations, reduction in foundation soil-bearing capacity, increases in lateral pressures on retaining walls, and flotation of embedded structures) and shall discuss mitigation measures. Such measures shall be given consideration in the design of the structure and can include, but are not limited to, ground stabilization, selection of appropriate foundation type and depths, selection of appropriate structural systems to accommodate anticipated displacements and forces, or any combination of these measures.

The potential for liquefaction and soil strength loss shall be evaluated for site peak ground accelerations, magnitudes, and source characteristics consistent with the design earthquake ground motions. Peak ground acceleration is permitted to be determined based on a site-specific study taking into account soil

amplification effects or, in the absence of such a study, peak ground accelerations shall be assumed equal to $S_{DS}/2.5$.

7.5.3 Foundation ties. Individual spread footings founded on soil assigned to Site Class E or F shall be interconnected by ties designed in accordance with Sec. 7.4.3.

7.5.4 Special pile and grade beam requirements. Piling shall be designed and constructed to withstand the maximum curvatures resulting from earthquake ground motions and structural response. Curvatures shall include the effects of free-field soil strains (without the structure), modified for soil-pile interaction, coupled with pile deformations induced by lateral pile resistance to structure seismic forces. Concrete piles in Site Class E or F shall be designed and detailed in accordance with Sec. 21.4.4.1, 21.4.4.2, and 21.4.4.3 of ACI 318 within seven pile diameters of the pile cap and of the interfaces between strata that are hard or stiff and strata that are liquefiable or are composed of soft to medium-stiff clay.

Section 21.10.3.3 of ACI 318 need not apply where grade beams have the required strength to resist the forces from the load combinations of Section 4.2.2.2. Section 21.10.4.4(a) of ACI 318 need not apply to concrete piles.

Design of anchorage of piles into the pile cap shall consider the combined effect of axial forces due to uplift and bending moments due to fixity to the pile cap. For piles required to resist uplift forces or provide rotational restraint, anchorage into the pile cap shall be capable of developing the following:

1. In the case of uplift, the least of: the nominal tensile strength of the longitudinal reinforcement in a concrete pile, the nominal tensile strength of a steel pile, the nominal uplift strength of the soil-pile interface times 1.3, or the axial tension force calculated in accordance with Sec. 4.2.2.2. The nominal uplift strength of the soil-pile interface shall be taken as the ultimate frictional or adhesive force that can be developed between the soil and the pile.
2. In the case of rotational restraint, the lesser of: the load effects (axial forces, shear forces, and moments) calculated in accordance with Sec. 4.2.2.2, or development of the nominal axial, bending, and shear strength of the pile.

Splices of pile segments shall be capable of developing the lesser of: the nominal strength of the pile section, or the axial forces, shear forces, and moments calculated in accordance with Sec. 4.2.2.2.

Pile moments, shears, and lateral deflections used for design shall be established considering the interaction of the pile and soil. Where the ratio of the depth of embedment of the pile to the pile diameter or width is less than or equal to 6, the pile may be assumed to be flexurally rigid with respect to the soil.

Where the center-to-center spacing of piles in the direction of the lateral force is less than eight pile diameters, the effects of such spacing on the lateral response of the piles shall be included. Where the center-to-center spacing of piles is less than three pile diameters, the effects of such spacing on the vertical response of the piles shall be included.

Batter piles shall be capable of resisting forces and moments calculated in accordance with Sec. 4.2.2.2.

Where vertical and batter piles act jointly to resist foundation forces as a group, these forces shall be distributed to the individual piles in accordance with their relative horizontal and vertical rigidities and the geometric distribution of the piles within the group. The connection between batter piles and grade beams or pile caps shall be capable of developing the nominal strength of the pile acting as a short column.

7.5.4.1 Uncased concrete piles. The longitudinal reinforcement ratio for uncased cast-in-place concrete drilled or augered piles, piers, or caissons shall not be less than 0.005 throughout the largest region defined as follows: the top one-half of the pile length, the top 10 ft (3 m) below the ground, or the flexural length of the pile. The flexural length shall be taken as the length of pile to a point where 0.4 times the concrete section cracking moment exceeds the calculated flexural demand at that point.

Longitudinal reinforcement shall consist of at least four bars and shall be confined with closed ties or equivalent spirals at a spacing of not more than the least of: 12 times the diameter of the smallest longitudinal bar, one-half the diameter of the section, or 12 in. (300 mm). Ties shall have a diameter of not less than 3/8 in. (9.5 mm) where the pile diameter is less than or equal to 20 in. (500 mm) and not less than 1/2 in. (12.7 mm) for piles of larger diameter. Within three pile diameters of the bottom of the pile cap, transverse confinement reinforcing shall satisfy Sec. 21.4.4.1, 21.4.4.2, and 21.4.4.3 of ACI 318. Where the assigned Site Class is A, B, C, or D and the soil is not subject to liquefaction, it shall be permitted to use a transverse spiral reinforcing ratio of not less than one-half of that required in Sec. 21.4.4.1(a) of ACI 318.

7.5.4.2 Metal-cased concrete piles. Reinforcement requirements are the same as for uncased concrete piles.

Exception: Spiral welded metal-casing of a thickness not less than No. 14 gauge may be considered to provide concrete confinement equivalent to the closed ties or equivalent spirals required in an uncased concrete pile, provided that the metal casing is adequately protected against possible deleterious action due to soil constituents, changing water levels, or other factors indicated by boring records of site conditions.

7.5.4.3 Precast (non-prestressed) concrete piles. Within three pile diameters of the bottom of the pile cap, transverse confinement reinforcing shall satisfy Sec. 21.4.4.1, 21.4.4.2, and 21.4.4.3 of ACI 318. Where the assigned Site Class is A, B, C, or D and the soil is not subject to liquefaction, it shall be permitted to use a transverse spiral reinforcing ratio of not less than one-half of that required in Sec. 21.4.4.1(a) of ACI 318.

7.5.4.4 Precast-prestressed piles. The requirements of ACI 318 need not apply, unless specifically referenced.

Where the total pile length in the soil is 35 ft (11 m) or less, transverse confinement reinforcement shall be provided throughout the length of the pile. Where the pile length exceeds 35 ft (11 m), transverse confinement reinforcement shall be provided throughout the largest region defined as follows: the top 35 ft (11 m) below the ground, or the distance from the underside of the pile cap to the first point of zero curvature plus three times the least pile dimension. The transverse confinement reinforcement shall be spiral or hoop reinforcement with a center-to-center spacing not greater than the least of: one-fifth of the least pile dimension, six times the diameter of the longitudinal tendons, or 8 in. (200 mm).

Where the transverse confinement reinforcement consists of spirals or circular hoops, the volumetric ratio of transverse reinforcement shall not be less than that required by Eq. 7.5-1 and 7.5-2, but need not exceed 0.021.

$$\rho_s = 0.25 \left(\frac{f'_c}{f_{yh}} \right) \left(\frac{A_g}{A_{ch}} - 1 \right) \left(0.5 + \frac{1.4P}{f'_c A_g} \right) \quad (7.5-1)$$

$$\rho_s = 0.12 \left(\frac{f'_c}{f_{yh}} \right) \left(0.5 + \frac{1.4P}{f'_c A_g} \right) \quad (7.5-2)$$

where:

ρ_s = volumetric ratio of transverse reinforcement (volume of transverse reinforcement divided by volume of enclosed core),

f'_c = specified compressive strength of concrete,

f_{yh} = yield strength of transverse reinforcement, which shall not be taken greater than 85,000 psi (586 MPa),

A_g = pile cross-sectional area,

A_{ch} = core area defined by outside diameter of the transverse reinforcement, and

P = axial load on pile calculated in accordance with Sec. 4.2.2.

Where the transverse confinement reinforcement consists of rectangular hoops and cross ties, the total cross-sectional area of transverse reinforcement shall not be less than that required by Eq. 7.5-3 and 7.5-4.

$$A_{sh} = 0.3sh_c \left(\frac{f'_c}{f_{yh}} \right) \left(\frac{A_g}{A_{ch}} - 1 \right) \left(0.5 + \frac{1.4P}{f'_c A_g} \right) \quad (7.5-3)$$

$$A_{sh} = 0.12sh_c \left(\frac{f'_c}{f_{yh}} \right) \left(0.5 + \frac{1.4P}{f'_c A_g} \right) \quad (7.5-4)$$

where:

s = spacing of transverse reinforcement measured along length of pile,

h_c = cross-sectional dimension of pile core measured center-to-center of hoop reinforcement,

f'_c = specified compressive strength of concrete, and

f_{yh} = yield strength of transverse confinement reinforcement, which shall not be taken greater than 70,000 psi (483 Mpa).

Outside of the length of the pile requiring transverse confinement reinforcement, spiral or hoop reinforcement with a volumetric ratio not less than one-half of that required for transverse confinement reinforcement shall be provided.

Circular spiral reinforcement shall be spliced by lapping one full turn and bending the end of the spiral to a 90-degree hook or by use of a mechanical or welded splice complying with Sec. 12.14.3 of ACI 318. The required amount of spiral reinforcement shall be permitted to be obtained by providing an inner and outer spiral.

Hoops and cross ties shall have a diameter of not less than 3/8 in. (9.5 mm). Rectangular hoop ends shall terminate at a corner with seismic hooks.

7.5.4.5 Steel Piles. Design and detailing of H-piles shall conform to the provisions of AISC Seismic and the following. The connection between steel piles (including unfilled steel pipe piles) and pile caps shall be designed for a tensile force no smaller than 10 percent of the nominal compression strength of the pile.

Exception: The pile connection need not meet this requirement where it can be demonstrated that the pile connection has the strength to resist the axial forces and moments calculated in accordance with Sec. 4.2.2.2.

This page is intentionally left blank.

Appendix to Chapter 7

GEOTECHNICAL ULTIMATE STRENGTH DESIGN OF FOUNDATIONS AND FOUNDATION LOAD-DEFORMATION MODELING

PREFACE: This appendix introduces ultimate strength design (USD) procedures for the geotechnical design of foundations for trial use and evaluation by design professionals prior to adoption into a subsequent edition of the *Provisions*. Similarly, the appendix also introduces criteria for the modeling of load-deformation characteristics of the foundation-soil system (foundation stiffness) for those analysis procedures in Chapter 5 that permit the use of realistic assumptions for foundation stiffness rather than the assumption of a fixed base.

Current practice for geotechnical foundation design is based on allowable stresses with allowable foundation load capacities for dead plus live loads based on limiting long-term static settlements and providing a large factor of safety. In current practice, allowable soil stresses for dead plus live loads are typically increased by one-third for load combinations that include wind or seismic forces. The allowable stresses for dead plus live loads are often far below ultimate soil capacity. This *Provisions* appendix and the associated *Commentary* appendix provide criteria and guidance for the direct use of ultimate foundation load capacity for load combinations that include seismic forces. The acceptance criteria covers both the analyses for fixed-base assumptions and analyses for linear and nonlinear modeling of foundation stiffness for flexible-base assumptions.

Although USD for foundations has not previously been included in design provisions for new buildings, the same basic principles used in this appendix have been adapted to generate guidelines for the seismic evaluation and retrofit design of existing buildings (FEMA 273, FEMA 356, and ATC 40). The criteria and procedures presented herein for the nonlinear modeling of foundation stiffness, combining a linear or multilinear stiffness and a limiting load capacity based on ultimate soil strength, are essentially the same as those presented in the FEMA and ATC publications identified above.

With respect to the adoption of USD procedures for geotechnical foundation design, the primary issue considered by the Provision Update Committee and the BSSC member organizations has been the impact of the proposed USD procedures on the size of foundations and consequent effect on the potential for foundation rocking and building performance. TS3 has conducted a limited number of design examples, a synopsis of which is presented at the end of the Commentary for the Appendix to Chapter 7. The example results illustrate the expected effects of the methodology, in that relative foundation sizes from USD vs ASD are related to the factor of safety on load capacity under vertical dead plus live loads. When factors of safety are high, smaller foundations result from USD, but when factors of safety are low, it is possible that foundations may be larger using USD. Additional examples, including nonlinear dynamic analyses incorporating nonlinear load-deformation models for foundation soil stiffness and capacity, are warranted to further evaluate and possibly refine the methodology and criteria. It is hoped that trial usage of the methodologies presented herein will allow the necessary consensus to be developed to permit later incorporation into the *Provisions*. Please direct feed-back on this appendix and its commentary to the BSSC.

A7.1 GENERAL

A7.1.1 Scope. This appendix includes only those foundation requirements that are specifically related to seismic resistant construction. It assumes compliance with all other basic requirements which include, but are not limited to, requirements for the extent of the foundation investigation, fills to be present or to be placed in the area of the structure, slope stability, subsurface drainage, settlement

control, and soil bearing and lateral soil pressure recommendations for loads acting without seismic forces.

A7.1.2 Definitions

Allowable foundation load capacity: See Sec. A 7.2.2.

Ultimate foundation load capacity: See Sec. A 7.2.2.

A7.1.3 Notation

Q_{as} Allowable foundation load capacity.

Q_{us} Ultimate foundation load capacity.

ϕ The strength reduction, capacity reduction, or resistance factor.

A7.2 GENERAL DESIGN REQUIREMENTS

The resisting capacities of the foundations, subjected to the load combinations prescribed elsewhere in these *Provisions*, shall meet the requirements of this appendix.

A7.2.1 Foundation components. The strength and detailing of foundation components under seismic loading conditions, including foundation elements and attachments of the foundation elements to the superstructure, shall comply with the requirements of Chapters 8, 9, 10, 11, or 12, unless otherwise specified in this chapter. The strength of foundation components shall not be less than that required for load combinations that do not include seismic load effects.

A7.2.2. Foundation load capacities. The vertical capacity of foundations (footings, piles, piers, mats or caissons) as limited by the soil shall be sufficient to support the structure for all prescribed load combinations without seismic forces, taking into account the settlement that the structure can withstand while providing an adequate factor of safety against failure. Such capacities are defined as allowable foundation load capacities, Q_{as} . For load combinations including seismic load effects as specified in Sec. 4.2.2, vertical, lateral, and rocking load capacities of foundations as limited by the soil shall be sufficient to resist loads with acceptable deformations, considering the short duration of loading, the dynamic properties of the soil, and the ultimate load capacities, Q_{us} , of the foundations under vertical, lateral, and rocking loading.

A7.2.2.1 Determination of ultimate foundation load capacities. Ultimate foundation load capacities shall be determined by a qualified geotechnical engineer based on geotechnical site investigations that include field and laboratory testing to determine soil classification and soil strength parameters, and/or capacities based on insitu testing of prototype foundations. For competent soils that do not undergo strength degradation under seismic loading, strength parameters for static loading conditions shall be used to compute ultimate load capacities for seismic design. For sensitive cohesive soils or saturated cohesionless soils, the potential for earthquake induced strength degradation shall be considered.

Ultimate foundation load capacities, Q_{us} , under vertical, lateral, and rocking loading shall be determined using accepted foundation design procedures and principles of plastic analysis. Calculated ultimate load capacities, Q_{us} , shall be best-estimated values using soil properties that are representative average values for individual foundations. Best-estimated values of Q_{us} shall be reduced by resistance factors (ϕ) to reflect uncertainties in site conditions and in the reliability of analysis methods. The factored foundation load capacity, ϕQ_{us} , shall then be used to check acceptance criteria, and as the foundation capacity in foundation nonlinear load-deformation models.

If ultimate foundation load capacities are determined based on geotechnical site investigations including laboratory or in-situ tests, ϕ -factors equal to 0.8 for cohesive soils and 0.7 for cohesionless soils shall be used for vertical, lateral, and rocking resistance for all foundation types. If ultimate

foundation load capacities are determined based on full-scale field-testing of prototype foundations, ϕ -factors equal to 1.0 for cohesive soils and 0.9 for cohesionless soils are permitted.

A7.2.2.2 Acceptance criteria. For linear analysis procedures (Sec. 5.2, 5.3, and 5.4), factored foundation load capacities, ϕQ_{us} , shall not be exceeded for load combinations that include seismic load effects.

For the nonlinear response history procedure (Sec. 5.5) and the nonlinear static procedure (Appendix to Chapter 5), if the factored foundation load capacity, ϕQ_{us} , is reached during seismic loading, the potential significance of associated transient and permanent foundation displacements shall be evaluated. Foundation displacements are acceptable if they do not impair the continuing function of Seismic Use Group III structures or the life safety of any structure.

For nonlinear analysis procedures, an additional evaluation of structural behavior shall be performed to check potential changes in structural ductility demands due to higher than anticipated foundation capacity. For this additional evaluation, values of Q_{us} shall be increased by the factor $1/\phi$.

A7.2.3 Foundation load-deformation modeling. Where permitted for the analysis procedures in Chapter 5 and the Appendix to Chapter 5, the load-deformation characteristics of the foundation-soil system (foundation stiffness), if included in the analysis, shall be modeled in accordance with the requirements of this section. For linear analysis methods, the linear load-deformation behavior of foundations shall be represented by an equivalent linear stiffness using soil properties that are compatible with the soil strain levels associated with the design earthquake motion. The strain-compatible shear modulus, G , and the associated strain-compatible shear wave velocity, v_s , needed for the evaluation of equivalent linear stiffness shall be determined using the criteria in Sec. 5.6.2.1.1 or based on a site-specific study. Parametric variations of not less than 50 percent increase and decrease in stiffness shall be incorporated in dynamic analyses unless smaller variations can be justified based on field measurements of dynamic soil properties or direct measurements of dynamic foundation stiffness.

For nonlinear analysis methods, the nonlinear load-deformation behavior of the foundation-soil system may be represented by a bilinear or multilinear curve having an initial equivalent linear stiffness and a limiting foundation capacity. The initial equivalent linear stiffness shall be determined as described above for linear analysis methods. The limiting foundation capacity shall be taken as the factored foundation load capacity, ϕQ_{us} . Parametric variations in analyses shall include: (1) a reduction in stiffness of 50 percent combined with a limiting foundation capacity, ϕQ_{us} , and (2) an increase in stiffness of 50 percent combined with a limiting foundation capacity equal to Q_{us} increased by a factor $1/\phi$.

This page is intentionally left blank

Chapter 8

STEEL STRUCTURE DESIGN REQUIREMENTS

8.1 GENERAL

8.1.1 Scope. The design, construction, and quality of steel components that resist seismic forces shall comply with the requirements of this chapter.

8.1.2 References. The following documents shall be used as specified in this chapter.

- AISC ASD *Allowable Stress Design and Plastic Design Specification for Structural Steel Buildings*, American Institute of Steel Construction, 1989 including supplement No. 1, (2001).
- AISC LRFD *Load and Resistance Factor Design Specification for Structural Steel Buildings*, American Institute of Steel Construction, 1999.
- AISC Seismic *Seismic Provisions for Structural Steel Buildings, Part I*, American Institute of Steel Construction, 2002.
- AISI—NASPEC *North American Specification for the Design of Cold-formed Steel Structural Members*, American Iron and Steel Institute, 2001.
- AISI—GP Standard for Cold-Formed Steel Framing—General Provisions, American Iron and Steel Institute, 2001
- AISI—PM Standard for Cold-Formed Steel Framing—Prescriptive Method for One and Two-Family Dwellings, American Iron and Steel Institute, 2001,
- ASCE 8 *Specification for the Design of Cold-formed Stainless Steel Structural Members*, American Society of Civil Engineers, 2002.
- SJI *Standard Specification, Load Tables and Weight Tables for Steel Joists and Joist Girders*, Steel Joist Institute, 2002.
- ASCE 19 *Structural Applications of Steel Cables for Buildings*, American Society of Civil Engineers, 1996.
- AWS D1.1 *Structural Welding Code Steel*, American Welding Society, 2000.
- ASTM A 653 *Specification for Steel Sheet, Zinc-Coated (Galvanized) or Zinc-Iron Alloy-Coated (Galvannealed) by the Hot-dip Process (A 653-97a)*, American Society for Testing and Materials, 1997.
- ASTM A 792 *Specification for Steel Sheet, 55% Aluminum-Zinc Alloy-Coated by the Hot-dip Process (A 792-97a)*, American Society for Testing and Materials, 1997.
- ASTM A 875 *Specification for Steel Sheet, Zinc-5% Aluminum Alloy-Coated by the Hot-dip Process (A 875-97a)*, American Society for Testing and Materials, 1997.

8.1.3 Definitions

Dead load: See Sec. 4.1.3.

Design strength: See Sec. 4.1.3.

Diaphragm: See Sec. 4.1.3.

Light-framed wall: See Sec. 12.1.3.

Light-framed shear wall: See Sec. 12.1.3.

Live load: See Sec. 4.1.3.

Nominal strength: See Sec. 4.1.3.

Registered design professional: See Sec. 2.1.3.

Required strength: See Sec. 4.1.3.

Seismic Design Category: See Sec. 1.1.4.

Seismic forces: See Sec. 1.1.4.

Shear panel: See Sec. 4.1.3.

Shear wall: See Sec. 4.1.3.

Story: See Sec. 4.1.3.

Structure: See Sec. 1.1.4.

Wall: See Sec. 4.1.3.

8.1.4 Notation

R See Sec. 4.1.4.

T_3 Net tension in steel cable due to dead load, prestress, and seismic load (Sec. 8.5).

T_4 Net tension in steel cable due to dead load, prestress, live load, and seismic load (Sec. 8.5).

ϕ See Sec. 5.1.3.

Ω_0 See Sec. 4.1.4.

8.2 GENERAL DESIGN REQUIREMENTS

8.2.1 Seismic Design Categories B and C. Steel structures assigned to Seismic Design Category B or C shall be of any construction permitted by the references in Sec. 8.1.2. An R factor as set forth in Table 4.3-1 for the appropriate steel system is permitted where the structure is designed and detailed in accordance with the requirements of AISC Seismic, as modified in Sec. 8.3, or in accordance with Sec. 8.4.1 and 8.4.2, for light-frame cold-formed steel wall systems. Systems not detailed in accordance with the above shall use the R factor in Table 4.3-1 designated for “Steel Systems Not Specifically Detailed for Seismic Resistance.”

8.2.2 Seismic Design Categories D, E, and F. Steel structures assigned to Seismic Design Category D, E, or F shall be designed and detailed in accordance with AISC Seismic as modified in Sec. 8.3. Light-frame cold-formed steel wall systems shall be designed and detailed in accordance with Sec. 8.4.2.

8.3 STRUCTURAL STEEL

8.3.1 Material properties for determination of required strength. Revise Table I-6-1 of AISC Seismic, as follows:

1. For the Application titled “Hot-rolled structural shapes and bars, All other grades,” change the R_y value from 1.1 to 1.2.

For the Application titled “All other products,” change the R_y value from 1.1 to 1.2.

8.4 COLD-FORMED STEEL

The design of cold-formed carbon or low-alloy steel members to resist seismic loads shall be in accordance with the requirements of AISI – NASPEC and AISI General and the design of cold-formed stainless steel structural members to resist seismic loads shall be in accordance with the requirements of ASCE 8, except as modified by this section.

8.4.1 Modifications to references

Modify Sec. 1.5.2 of ASCE 8 by substituting a load factor of 1.0 in place of 1.5 for nominal earthquake load.

8.4.2 Light-frame walls. Where required in Sec. 8.2.1 or 8.2.2, cold-formed steel stud walls designed in accordance with AISI – NASPEC, AISI-GP and ASCE 8 shall also comply with the requirements of this section.

8.4.2.1 Boundary members. All boundary members, chords, and collectors shall be designed to transmit the specified induced axial forces.

8.4.2.2 Connections. Connections for diagonal bracing members, top chord splices, boundary members, and collectors shall have a design strength equal to or greater than the nominal tensile strength of the members being connected or Ω_0 times the design seismic force. The pull-out resistance of screws shall not be used to resist seismic forces.

8.4.2.3 Braced bay members. In stud systems where the lateral forces are resisted by diagonal braces, the vertical and diagonal members in braced bays shall be anchored such that the bottom tracks are not required to resist uplift forces by bending of the track or track web. Both flanges of studs shall be braced to prevent lateral torsional buckling. In shear wall systems, the vertical boundary members shall be anchored so the bottom track is not required to resist uplift forces by bending of the track web.

8.4.2.4 Diagonal braces. Provision shall be made for pretensioning or other methods of installation of tension-only bracing to guard against loose diagonal straps.

8.4.2.5 Shear walls. Nominal shear strengths for shear walls framed with cold-formed steel studs are given in Table 8.4-1. Design shear strength shall be determined by multiplying the nominal shear strength by a ϕ factor of 0.55. The height to length ratio of wall systems listed in Table 8.4-1 shall not exceed 2:1. In structures over one story in height, the assemblies in Table 8.4-1 shall not be used to resist horizontal loads contributed by forces imposed by masonry or concrete construction.

Panel thicknesses shown in Table 8.4-1 shall be considered to be minimums. No panels less than 24 in. wide shall be used. Plywood or oriented strand board structural panels shall be of a type that is manufactured using exterior glue. Framing members, blocking or strapping shall be provided at the edges of all sheets. Fasteners along the edges in shear panels shall be placed not less than 3/8 in. (9.5 mm) in from panel edges. Perimeter members at openings shall be provided and shall be detailed to distribute the shearing stresses. Wood sheathing shall not be used to splice such members.

Studs shall be a minimum 1-5/8 in. (41 mm) by 3-1/2 in. (89 mm) with a 3/8-in. (9.5 mm) return lip. Track shall be a minimum 1-1/4 in. (32 mm) by 3-1/2 in. (89 mm). Both studs and track shall have a minimum uncoated base metal thickness of 0.033 in. (0.84 mm), shall not have an uncoated base metal thickness greater than 0.048 in. (1.22 mm), and shall satisfy the requirements for ASTM A 653 SS, Grade 33, ASTM A 792 SS, Grade 33, or ASTM A 875 SS, Grade 33. Panel end studs and their uplift anchorage shall have the design strength to resist the forces determined by the seismic loads determined using Eq. 4.2-3 and Eq. 4.2-4.

Framing screws shall be No. 8 x 5/8 in. (16 mm) wafer head self-drilling. Plywood and OSB screws shall be a minimum No. 8 x 1 in. (25 mm) bugle head. Where horizontal straps are used to provide blocking they shall be a minimum 1-1/2 in. (38 mm) wide and of the same material as the stud and track. Such straps shall have a thickness at least as great as the thicker of that of the stud and the track.

**Table 8.4-1 Nominal Shear Strength (plf)^a
for Shear Walls Framed with Cold-formed Steel Studs**

Assembly Description	Fastener Spacing at Panel Edges (in.) ^b				Framing Spacing
	6	4	3	2	
15/32 rated Structural I sheathing (4-ply) plywood one side ^c	780	990	1465	1625	24 in. o.c.
7/16 in. oriented strand board one side ^c	700	915	1275	1700	24 in. o.c.
^a For metric: 1 in. = 25.4 mm, 1 plf = 14.6 N/m.					
^b Screws in the field of the panel shall be installed 12 in. o.c. unless otherwise shown.					
^c Both flanges of the studs shall be braced in accordance with Sec. 8.4.2.3.					

8.4.3 Prescriptive framing

One and two family dwellings are permitted to be designed and constructed in accordance to the provisions in the AISI—PM subject to the limitations therein.

8.4.4 Steel deck diaphragms. Steel deck diaphragms shall be made from materials which satisfy the requirements of AISI and ASCE 8. Nominal strengths shall be determined in accordance with approved analytical procedures or with test procedures prepared by a registered design professional experienced in testing of cold-formed steel assemblies and approved by the authority having jurisdiction. Design strengths shall be determined by multiplying the nominal strength by a resistance factor, ϕ , equal to 0.60 (for mechanically connected diaphragms) and equal to 0.50 (for welded diaphragms). The steel deck installation for the structure, including fasteners, shall comply with the test assembly arrangement. Quality standards established for the nominal strength test shall be the minimum standards required for the steel deck installation, including fasteners.

8.5 STEEL CABLES

The design strength of steel cables shall be determined in accordance with ASCE 19 except as modified by these Provisions. A load factor of 1.1 shall be applied to the prestress force included in T_3 and T_4 as defined in Sec. 3.1.2 of ASCE 19. In Sec. 3.2.1 of ASCE 19, item (c) shall be replaced with “1.5 T_3 ” and item (d) shall be replaced with “1.5 T_4 ”.

8.6 RECOMMENDED PROVISIONS FOR BUCKLING-RESTRAINED BRACED FRAMES

The following shall be used in conjunction with AISC Seismic.

8.6.1 Symbols

- A_{sc} Area of the yielding segment of steel core, in.² (BRBF)
- P_{ysc} Axial yield strength of steel core, kips (BRBF)
- Q_b Maximum unbalanced load effect applied to beam by braces, kips. (BRBF)
- β Compression strength adjustment factor (BRBF)
- w Tension strength adjustment factor. (BRBF)

8.6.2 Glossary

Buckling Restrained Braced Frame (BRBF): A diagonally braced frame meeting the requirements of Sec. 8.6.3 in which all members of the bracing system are subjected primarily to axial forces and in which the limit state of compression buckling of braces is precluded at forces and deformations corresponding to 1.5 times the Design Story Drift.

Buckling-Restraining System: A system of restraints that limits buckling of the steel core in BRBF. This system includes the casing on the steel core and structural elements adjoining its connections. The buckling-restraining system is intended to permit the transverse expansion and longitudinal contraction of the steel core for deformations corresponding to 1.5 times the Design Story Drift.

Casing: An element that resists forces transverse to the axis of the brace thereby restraining buckling of the core. The casing requires a means of delivering this force to the remainder of the buckling-restraining system. The casing resists little or no force in the axis of the brace.

Steel Core: The axial-force-resisting element of braces in BRBF. The steel core contains a yielding segment and connections to transfer its axial force to adjoining elements; it may also contain projections beyond the casing and transition segments between the projections and yielding segment.

8.6.3 BUCKLING-RESTRAINED BRACED FRAMES (BRBF)

8.6.3.1 Scope. Buckling-restrained braced frames (BRBF) are expected to withstand significant inelastic deformations when subjected to the forces resulting from the motions of the Design Earthquake. BRBF shall meet the requirements in this section.

8.6.3.2 Bracing Members

8.6.3.2.1 Composition: Bracing members shall be composed of a structural steel core and a system that restrains the steel core from buckling.

8.6.3.2.1.1 Steel core. The steel core shall be designed to resist the entire axial force in the brace.

8.6.3.2.1.1.1 Required strength of steel core. The required axial strength of the brace shall not exceed the design strength of the steel core, ϕP_{ysc} ,

where $\phi = 0.9$

$$P_{ysc} = F_y A_{sc}$$

F_y = specified minimum yield strength of steel core

A_{sc} = net area of steel core

8.6.3.2.1.1.2 Detailing

8.6.3.2.1.1.2.1. Plates used in the steel core that are 2 in. thick or greater shall satisfy the minimum toughness requirements of Sec. 6.3 (AISC Seismic).

8.6.3.2.1.1.2.2. Splices in the steel core are not permitted.

8.6.3.2.1.2 Buckling-restraining system. The buckling-restraining system shall consist of the casing for the steel core. In stability calculations, beams, columns, and gussets connecting the core shall be considered parts of this system.

8.6.3.2.1.2.1 Restraint. The buckling-restraining system shall limit local and overall buckling of the

steel core for deformations corresponding to 1.5 times the Design Story Drift. The buckling-restraining system shall not be permitted to buckle within deformations corresponding to 1.5 times the Design Story Drift.

8.6.3.2.2 Testing. The design of braces shall be based upon results from qualifying cyclic tests in accordance with the procedures and acceptance criteria of Sec. 8.6.3.7. Qualifying test results shall consist of at least two successful cyclic tests: one is required to be a test of a brace subassembly that includes brace connection rotational demands complying with Sec. 8.6.3.7.4 and the other shall be either a uniaxial or a subassembly test complying with Sec. 8.6.3.7.5. Both test types are permitted to be based upon one of the following:

8.6.3.2.2.1 Types of qualifying tests

8.6.3.2.2.1.1. Tests reported in research or documented tests performed for other projects that are demonstrated to reasonably match project conditions.

8.6.3.2.2.1.2. Tests that are conducted specifically for the project and are representative of project member sizes, material strengths, brace-end connection configurations, and matching assembly and quality control processes.

8.6.3.2.2.2 Applicability. Interpolation or extrapolation of test results for different member sizes shall be justified by rational analysis that demonstrates stress distributions and magnitudes of internal strains that are consistent with or less severe than the tested assemblies and that considers the adverse effects of larger material and variations in material properties. Extrapolation of test results shall be based upon similar combinations of steel core and buckling-restraining system sizes. Tests shall be permitted to qualify a design when the provisions of Sec. 8.6.3.7 are met.

8.6.3.2.2.3 Compression strength adjustment factor (β). Shall be calculated as the ratio of the maximum compression force to the maximum tension force of the Test Specimen measured from the qualification tests specified in Sec. 8.6.3.7.6.3 for the range of deformations corresponding to 1.5 times the Design Story Drift. The larger value of β from the two required brace qualification tests shall be used. In no case shall β be taken as less than 1.0.

8.6.3.2.2.4 Tension strength adjustment factor (ω). Shall be calculated as the ratio of the maximum tension force measured from the qualification tests specified in Sec. 8.6.3.7.6.3 (for the range of deformations corresponding to 1.5 times the Design Story Drift) to the nominal yield strength of the Test Specimen. The larger value of ω from the two required qualification tests shall be used. Where the tested steel core material does not match that of the prototype, ω shall be based on coupon testing of the prototype material.

8.6.3.2.3 Quality assurance. The buckling restrained brace manufacturer shall establish a Quality Assurance Plan that complies with Sec. 16 (AISC Seismic) and the Code of Standard Practice for Steel Buildings and Bridges. The brace manufacturer shall submit the proposed Quality Assurance Plan to the Engineer of Record for review and approval. The fabrication of buckling restrained braces shall meet the requirements of the approved Quality Assurance Plan. Only buckling restrained braces meeting all applicable requirements of the approved Quality Assurance Plan will be used in construction.

8.6.3.3 Bracing connections

8.6.3.3.1 Required strength. The required strength of bracing connections in tension and compression (including beam-to-column connections if part of the bracing system) shall be $\beta\omega R_y P_{ysec}$.

Exception: The factor R_y need not be applied if P_{ysec} is established using yield stress determined from a coupon test or mill certificate.

8.6.3.3.2 Gusset Plate. The design of connections shall include considerations of local and overall buckling.

8.6.3.4 Special requirements related to bracing configuration

8.6.3.4.1 V-type and inverted-V-type bracing. V-type and inverted-V-type braced frames shall meet the following requirements:

8.6.3.4.1.1. A beam that is intersected by braces shall be continuous between columns and shall be designed to resist the effects of load combinations stipulated by the Applicable Building Code, assuming the bracing is not present. For load combinations that include seismic, a load Q_b shall be substituted for the term E . Q_b is the maximum load effect applied to the beam by the braces. This vertical and horizontal load effect shall be calculated using $\beta\omega P_{y_{sc}}$ for the brace in compression and $\omega P_{y_{sc}}$ for the brace in tension. The required flexural strength for the load combinations that include seismic shall not exceed M_y as defined in AISC LRFD Chapter F.

8.6.3.4.1.2 Beam stiffness. Beam deflections under the load combination $D+Q_b$ (as defined in 16.4a.1.) shall not exceed $L/240$, where L is the beam span between column lines.

8.6.3.4.1.3. Deformation. For the purposes of brace design and testing, the calculated maximum deformation of braces shall be increased by including the effect of the vertical deflection of the beam under the loading defined in Sec.8.6.3.4.1.1

8.6.3.4.1.4. Lateral support of the beam shall be provided when required for stability. The analysis shall include consideration of Q_b and the axial force in the beam.

8.6.3.4.2 K-Type Bracing. K-type braced frames are not permitted for BRBF.

8.6.3.5 Columns. Columns in BRBF shall meet the following requirements:

8.6.3.5.1 Width-thickness Ratios. Compression elements of columns shall satisfy the width-thickness limitations in Table I-8-1(AISC Seismic).

8.6.3.5.2 Splices. In addition to meeting the requirements in Sec. 8.3 (AISC Seismic), column splices in BRBF shall be designed to develop at least the nominal shear strength of the smaller connected member and 50 percent of the flexural strength of the smaller connected member. Splices shall be located in the middle one-third of the column clear height.

8.6.3.5.3 Required Strength. In addition to the requirements in Sec. 8.3 (AISC Seismic), the required strength of columns in BRBF shall be determined from load combinations as stipulated in the Applicable Building Code, except that the seismic axial forces shall be determined from the maximum brace forces that can be introduced at each level. The maximum brace tension force shall be taken as $\omega P_{y_{sc}}$. The maximum brace compression force shall be taken as $\beta\omega P_{y_{sc}}$. The required column strength need not exceed the maximum force that can be delivered by the system.

8.6.3.6 Beams. Beams in BRBF shall meet the following requirements:

8.6.3.6.1 Width-thickness ratios. Compression elements of beams shall satisfy the width-thickness limitations in Table I-8-1 (AISC Seismic).

8.6.3.6.2 Required Strength. The required strength of beams shall include the effects of dead and live loads in conjunction with axial forces corresponding to the maximum brace forces. The maximum brace tension force shall be taken as $\omega P_{y_{sc}}$. The maximum brace compression force shall be taken as $\beta\omega P_{y_{sc}}$.

8.6.3.7 Qualifying Cyclic Tests Of Buckling-Restrained Braces

8.6.3.7.1 Scope and purpose. This Appendix includes requirements for qualifying cyclic tests of individual buckling-restrained braces and buckling-restrained brace subassemblages, when required in these provisions. The purpose of the testing of individual braces is to provide evidence that a buckling-

restrained brace satisfies the requirements for strength and inelastic deformation in these provisions; it also permits the determination of maximum brace forces for design of adjoining elements. The purpose of testing of the brace subassembly is to provide evidence that the brace-design can satisfactorily accommodate the deformation and rotational demands associated with the design. Further, the subassembly test is intended to demonstrate that the hysteretic behavior of the brace in the subassembly is consistent with that of the individual brace elements tested uniaxially.

Alternative testing requirements are permitted when approved by the Engineer of Record and the regulatory agency.

This Appendix provides only minimum recommendations for simplified test conditions. If conditions in the actual building so warrant, additional testing shall be performed to demonstrate satisfactory and reliable performance of buckling-restrained braces during actual earthquake ground motions.

8.6.3.7.2 Symbols. The numbers in parenthesis after the definition of a symbol refers to the Section number in which the symbol is first used.

D_b Deformation quantity used to control loading of test specimen (total brace end rotation for the subassembly test specimen; total brace axial deformation for the brace test specimen) (Sec. 8.6.3.7.6).

D_{bm} Value of deformation quantity, D_b , corresponding to the design story drift (Sec. 8.6.3.7.6).

D_{by} Value of deformation quantity, D_b , at first significant yield of test specimen (Sec. 8.6.3.7.6).

8.6.3.7.3 Definitions

Brace Test Specimen: A single buckling-restrained brace element used for laboratory testing intended to model the brace in the Prototype.

Design Methodology: A set of step-by-step procedures, based on calculation or experiment, used to determine sizes, lengths, and details in the design of buckling-restrained braces and their connections.

Inelastic Deformation: The permanent or plastic portion of the axial displacement in a buckling-restrained brace, divided by the length of the yielding portion of the brace, expressed in percent.

Prototype: The brace, connections, members, steel properties, and other design, detailing, and construction features to be used in the actual building frame.

Subassembly Test Specimen: The combination of the brace, the connections and testing apparatus that replicate as closely as practical the axial and flexural deformations of the brace in the Prototype.

Test Specimen: Brace Test Specimen or Subassembly Test Specimen.

8.6.3.7.4 Subassembly test specimen. The subassembly test specimen shall satisfy the following requirements:

1. The mechanism for accommodating inelastic curvature in the subassembly test specimen brace shall be the same as that of the prototype. The rotational deformation demands on the subassembly Test Specimen brace shall be equal to or greater than those of the Prototype.
2. The axial yield strength of the steel core of the brace in the subassembly test specimen shall not be less than of that of the prototype as determined from mill certificate or coupon test.
3. The cross-sectional shape and orientation of the steel core projection of the subassembly test specimen brace shall be the same as that of the brace in the Prototype.
4. The same documented design methodology shall be used for design of the subassembly and brace and of the Prototype and for comparison of the rotational deformation demands on the subassembly brace and on the prototype in the construction.

5. The calculated margins of safety for the prototype connection design, steel core projection stability, overall buckling and other relevant subassemblage test specimen brace construction details, excluding the gusset plate, for the Prototype, shall equal or exceed those of the subassemblage test specimen construction.
6. Lateral bracing of the subassemblage test specimen shall replicate the lateral bracing in the prototype.
7. The brace test specimen and the prototype shall be manufactured in accordance with the same quality control and assurance processes and procedures.

Extrapolation beyond the limitations stated in this section shall be permitted subject to qualified peer review and building official approval.

8.6.3.7.5 Brace test specimen. The brace test specimen shall replicate as closely as is practical the pertinent design, detailing, construction features, and material properties of the prototype.

8.6.3.7.5.1 Design of brace test specimen. The same documented design methodology shall be used for the brace test specimen and the prototype. The design calculations shall demonstrate, at a minimum, the following requirements:

1. The calculated margin of safety for stability against overall buckling for the prototype shall equal or exceed that of the brace test specimen.
2. The calculated margins of safety for the brace test specimen and the prototype shall account for differences in material properties, including yield and ultimate stress, ultimate elongation, and toughness.

8.6.3.7.5.2 Manufacture of brace test specimen. The brace test specimen and the prototype shall be manufactured in accordance with the same quality control and assurance processes and procedures.

8.6.3.7.5.3 Similarity of brace test specimen and prototype. The brace test specimen shall meet the following requirements:

1. The cross-sectional shape and orientation of the steel core shall be the same as that of the prototype.
2. The axial yield strength of the steel core of the brace test specimen shall not vary by more than 50 percent from that of the prototype as determined from mill certificates or coupon tests.
3. The material for, and method of, separation between the steel core and the buckling restraining mechanism in the brace test specimen shall be the same as that in the prototype.

Extrapolation beyond the limitations stated in this section shall be permitted subject to qualified peer review and building official approval.

8.6.3.7.5.4 Connection details. The connection details used in the brace test specimen shall represent the Prototype connection details as closely as practical.

8.6.3.7.5.5 Materials

1. Steel core: The following requirements shall be satisfied for the steel core of the brace test specimen:
 - a. The nominal yield stress of the prototype steel core shall be the same as that of the brace test specimen.
 - b. The yield strength of the material of the steel core in the prototype shall not exceed 110 percent of that of the brace test specimen as determined from mill certificates or coupon tests.
 - c. The specified minimum ultimate stress and strain of the prototype steel core shall meet

or exceed those of the brace test specimen.

2. Buckling-restraining mechanism: Materials used in the buckling-restraining mechanism of the brace test specimen shall be the same as those used in the prototype.

8.6.3.7.5.6 Welds. The welds on the test specimen shall replicate those on the prototype as close as practical. The following parameters shall be the same or more stringent in the prototype as in the test specimen: welding procedure specification, minimum filler metal toughness, welding positions, and inspection and nondestructive testing requirements and acceptance criteria.

8.6.3.7.5.7 Bolts. The bolted portions of the brace test specimen shall replicate the bolted portions of the prototype as closely as possible.

8.6.3.7.6 Loading history

8.6.3.7.6.1 General requirements. The test specimen shall be subjected to cyclic loads according to the requirements prescribed on Sec. 8.3.7.6.2 and 8.3.7.6.3. Additional increments of loading beyond those described in Sec. 8.3.7.6.3 are permitted. Each cycle shall include a full tension and full compression excursion to the prescribed deformation.

8.6.3.7.6.2 Test Control. The test shall be conducted by controlling the level of axial or rotational deformation, (D_b) imposed on the test specimen. As an alternate, the maximum rotational deformation may be applied and maintained as the protocol is followed for axial deformation.

8.6.3.7.6.3 Loading sequence. Loads shall be applied to the test specimen to produce the following deformations, where the deformation is the steel core axial deformation for the Test Specimen and the rotational deformation demand for the subassembly test specimen brace:

1. 6 cycles of loading at the deformation corresponding to $D_b = D_{by}$
2. 4 cycles of loading at the deformation corresponding to $D_b = 0.50 D_{bm}$
3. 4 cycles of loading at the deformation corresponding to $D_b = 1 D_{bm}$
4. 2 cycles of loading at the deformation corresponding to $D_b = 1.5 D_{bm}$
5. Additional complete cycles of loading at the deformation corresponding to $D_b = 1 D_{bm}$ as required for the Brace Test Specimen to achieve a cumulative inelastic axial deformation of at least 140 times the yield deformation (not required for the subassembly test specimen).

The design story drift shall not be taken as less than 0.01 times the story height for the purposes of calculating D_{bm} . D_{bm} need not be taken as greater than $5D_{by}$.

Other loading sequences are permitted to be used to qualify the test specimen when they are demonstrated to be of equal or greater severity in terms of maximum and cumulative inelastic deformation.

8.6.3.7.7 Instrumentation. Sufficient instrumentation shall be provided on the test specimen to permit measurement or calculation of the quantities listed in Sec. 8.6.3.7.9.

8.6.3.7.8 Materials testing requirements

8.6.3.7.8.1 Tension testing requirements. Tension testing shall be conducted on samples of steel taken from the same material as that used to manufacture the steel core. Tension-test results from certified mill test reports shall be reported but are not permitted to be used in place of specimen testing for the purposes of this Section. Tension-test results shall be based upon testing that is conducted in accordance with Sec. 8.6.3.7.8.2.

8.6.3.7.8.2 Methods of tension testing. Tension testing shall be conducted in accordance with ASTM A6, ASTM A370, and ASTM E8, with the following exceptions:

1. The yield stress, F_y , that is reported from the test shall be based upon the yield strength definition in ASTM A370, using the offset method of 0.002 strain.
2. The loading rate for the tension test shall replicate, as closely as is practical, the loading rate used for the Test Specimen.

8.6.3.7.9 Test reporting requirements

For each Test Specimen, a written test report meeting the requirements of this section shall be prepared. The report shall thoroughly document all key features and results of the test. The report shall include the following information:

1. A drawing or clear description of the test specimen, including key dimensions, boundary conditions at loading and reaction points, and location of lateral bracing if any.
2. A drawing of the connection details showing member sizes, grades of steel, the sizes of all connection elements, welding details including filler metal, the size and location of bolt holes, the size and grade of bolts, and all other pertinent details of the connections.
3. A listing of all other essential variables as listed in Sec. 8.6.3.7.4 or 8.6.3.7.5 as appropriate.
4. A listing or plot showing the applied load or displacement history.
5. A plot of the applied load versus the deformation (D_b). The method used to determine the deformations shall be clearly shown. The locations on the Test Specimen where the loads and deformations were measured shall be clearly identified.
6. A chronological listing of significant test observations, including observations of yielding, slip, instability, transverse displacement along the Test Specimen and fracture of any portion of the Test Specimen and connections, as applicable.
7. The results of the material tests specified in Sec. 8.6.3.7.8.
8. The manufacturing quality control and quality-assurance plans used for the fabrication of the test specimen. These shall be included with the welding procedure specifications and welding inspection reports.

Additional drawings, data, and discussion of the test specimen or test results are permitted to be included in the report.

8.6.3.7.10 Acceptance criteria. At least one subassembly test shall be performed to satisfy the requirements of Sec. 8.6.3.7.4. At least one brace test shall be performed to satisfy the requirements of Sec. 8.6.3.7.5. Within the required protocol range all tests shall satisfy the following requirements:

1. The plot showing the applied load vs. displacement history shall exhibit stable, repeatable behavior with positive incremental stiffness.
2. There shall be no fracture, brace instability or brace end connection failure.
3. For brace tests, each cycle to a deformation greater than D_{by} , the maximum tension and compression forces shall not be less than $1.0 P_{ysec}$.
4. For brace tests, each cycle to a deformation greater than D_{by} , the ratio of the maximum compression force to the maximum tension force shall not exceed 1.3.

Other acceptance criteria may be adopted for the brace test specimen or subassembly test specimen subject to qualified peer review and building official approval.

8.7 RECOMMENDED PROVISIONS FOR SPECIAL STEEL PLATE WALLS

The following shall be used in conjunction with AISC Seismic.

8.7.1 Symbols

t_w	Thickness of the web
L_{cf}	Clear distance between vertical boundary elements (VBEs) flanges.
h	Distance between horizontal boundary elements (HBE) centerlines.
A_b	The average of the cross-sectional area of a HBE bounding the panel.
A_c	The average of the cross-sectional area of a VBE bounding the panel.
I_c	Moment of inertia of a VBE.
L	Distance between VBE centerlines.
α	Angle of web yielding.

8.7.2 Glossary

Webs: The slender unstiffened steel plates connected to surrounding horizontal and vertical boundary elements to resist lateral loads.

Horizontal boundary elements are structural shapes oriented horizontally and framing the Webs of special steel plate walls.

Vertical boundary elements are structural shapes oriented vertically and framing the Webs of special steel plate walls.

Panel: Each Web and its surrounding elements constitute a panel.

8.7.3 Scope. Special steel plate walls (SSPWs) are expected to withstand significant inelastic deformations in the Webs when subjected to the forces resulting from the motions of the design earthquake. The HBEs and VBEs adjacent to the webs shall be designed to remain essentially elastic under the maximum forces that can be generated by the fully yielded webs, except that plastic hinging at the ends of HBEs is permitted. SSPWs shall meet the requirements in this section.

8.7.4 Webs**8.7.4.1**

The nominal strength of a panel is given by:

$$V_n = 0.42 F_y t_w L_{cf} \sin 2\alpha$$

where :

t_w is the thickness of the web,

L_{cf} is the clear distance between VBE flanges, and

α is given by

$$\tan^4 \alpha = \frac{1 + \frac{t_w L}{2A_c}}{1 + t_w h \left(\frac{1}{A_b} + \frac{h^3}{360I_c L} \right)}$$

where:

h = the distance between HBE centerlines,

A_b = cross-sectional area of a HBE,

A_c = cross-sectional area of a VBE,

I_c = moment of inertia of a VBE, and

L = the distance between VBE centerlines.

The panel design strength shall be ϕV_n , where ϕ is 0.9.

8.7.4.2 Panel aspect ratio. The ratio of panel length to height, L/h , shall be greater than 0.8, but shall not exceed 2.5.

8.7.4.3 Openings in webs. Openings in webs shall be bounded on all sides by HBE's and VBE's extending the full width and height of the panel respectively, unless otherwise justified by testing and analysis.

8.7.4.4 Maximum slenderness ratio for plates. The maximum width-thickness ratio of plate elements shall be $25\sqrt{E/F_y}$. The width shall be taken as the shortest distance between boundary elements.

8.7.5 Connections of webs to boundary elements. The required strength of Web connections to the surrounding HBE's and VBE's shall equal the expected yield strength, in tension, of the Web calculated at an angle α .

8.7.6 Horizontal and vertical boundary elements (HBEs and VBEs)

8.7.6.1 Strength of boundary elements. In addition to the requirements of Sect. 8.3 of AISC Seismic, the required strength of VBE's shall be based upon the forces corresponding to the expected yield strength (in tension) of the Web calculated at an angle α .

The required strength of HBE's shall be the greater of the forces corresponding to the expected yield strength (in tension) of the Web calculated at an angle α or that determined from the load combinations in ASCE 7 assuming the web provides no support for gravity loads.

8.7.6.2 HBE to VBE connections. HBE to VBE connections shall be made with HBE flanges welded to VBE. HBE webs may be bolted or welded to VBE. Partial joint penetration welds are not permitted at the HBE flange weld. The connection shall have a required strength M_u of at least $1.1R_yM_p$ of the HBE. The required shear strength V_u of a HBE-to-VBE connection shall be determined from the load combinations as stipulated in the ASCE 7 except that the required shear strength shall not be less than the shear corresponding to moments at each end equal to $1.1R_yM_p$ together with the shear resulting from the expected tensile strength of the Webs yielding at an angle α .

8.7.6.3 Boundary elements compactness. The width-thickness ratios of HBEs and VBEs shall comply with the requirements in Table I-8-1(AISC Seismic)

Modify Footnotes b and c to Table I-8-1(AISC Seismic) by including SSPW to both footnotes.

8.7.6.4 Lateral Bracing. HBE's shall be laterally braced at all intersections with VBE's and at a spacing not to exceed $0.086 r_y E_s / F_y$. Both flanges of HBE's shall be braced either directly or indirectly. The required strength of lateral bracing shall be at least 2 percent of the HBE's flange nominal strength, $F_y b_f t_f$. The required stiffness of all lateral bracing shall be determined in accordance with Equations C3-8 or C3-10 as applicable in the AISC LRFD. In these equations, M_u shall be computed as $R_y Z F_y$.

8.7.6.5 VBE splices. VBE splices shall comply with the requirements of Sec. 8.4 (AISC Seismic).

8.7.6.6 Panel zones. The VBE panel zone next to the top and base horizontal boundary elements of the SSPW shall comply with the requirements in Sec. 9.3 (AISC Seismic).

8.7.6.7 Stiffness of vertical boundary elements. The VBE shall have moments of inertia about an axis perpendicular to the direction of the web plate, I_c , not less than $0.00307 t_w h^4 / L$.

This page is intentionally left blank.

Chapter 9

CONCRETE STRUCTURE DESIGN REQUIREMENTS

9.1 GENERAL

9.1.1 Scope. The quality and testing of concrete and steel (reinforcing and anchoring) materials and the design and construction of concrete components that resist seismic forces shall comply with the requirements of ACI 318 except as modified in this chapter.

9.1.2 References. The following documents shall be used as specified in this chapter.

ACI 318	<i>Building Code Requirements for Structural Concrete</i> , American Concrete Institute, 2002.
ACI T1.1	<i>Acceptance Criteria for Moment Frames Based on Structural Testing</i> , American Concrete Institute, 2001.
ATC-24	<i>Guidelines for Seismic Testing of Components of Steel Structures</i> , Applied Technology Council, 1992.

9.1.3 General definitions

Base: See Sec. 4.1.3. Base is defined as “base of structure” in Sec. 21.1 of ACI 318.

Basement: See Sec. 7.1.3.

Boundary elements: See Sec. 2.1.3 and Sec. 21.1 of ACI 318.

Confined region: The portion of a reinforced concrete component in which the concrete is confined by closely spaced special transverse reinforcement restraining the concrete in directions perpendicular to the applied stress.

Coupling beam: A beam that is used to connect adjacent concrete wall elements to make them act together as a unit to resist lateral loads.

Design strength: See Sec. 4.1.3.

Diaphragm: See Sec. 4.1.3. Diaphragm is defined as “structural diaphragm” in Sec. 21.1 of ACI 318.

Intermediate moment frame: See Sec. 4.1.3 and Sec. 21.1 of ACI 318.

Joint: See Sec. 21.1 of ACI 318.

Moment frame: See Sec. 4.1.3 and Sec. 21.1 of ACI 318.

Nominal strength: See Sec. 4.1.3.

Ordinary moment frame: See Sec. 4.1.3 and Sec. 21.1 of ACI 318.

Plain concrete: See Sec. 2.1 of ACI 318.

Reinforced concrete: See Sec. 2.1 of ACI 318.

Required strength: See Sec. 4.1.3.

Seismic Design Category: See Sec. 1.1.4.

Seismic-force-resisting system: See Sec. 1.1.4. Seismic-force-resisting system is defined as “lateral-force-resisting system” in Sec. 21.1 of ACI 318.

Seismic forces: See Sec. 1.1.4. Seismic forces are defined as “specified lateral forces” in Sec. 21.1 of ACI 318.

Shear wall: See Sec. 4.1.3. Shear walls are defined as “structural walls” in Sec. 21.1 of ACI 318.

Special moment frame: See Sec. 4.1.3 and Sec. 21.1 of ACI 318.

Special transverse reinforcement: Reinforcement composed of spirals, closed stirrups, or hoops and supplementary cross-ties provided to restrain the concrete and qualify the portion of the component, where used, as a confined region.

Story: See Sec. 4.1.3.

Structure: See Sec. 1.1.4.

Wall: See Sec. 4.1.3.

9.2 GENERAL DESIGN REQUIREMENTS

9.2.1 Classification of shear walls. Structural concrete shear walls that resist seismic forces shall be classified in accordance with this section.

9.2.1.1 Ordinary plain concrete shear walls. Ordinary plain concrete shear walls shall satisfy the requirements of Sec. 21.1 of ACI 318 for ordinary structural plain concrete walls.

9.2.1.2 Detailed plain concrete shear walls. Detailed plain concrete shear walls above the base shall satisfy the requirements of Sec. 21.1 of ACI 318 for ordinary structural plain concrete walls and contain reinforcement as follows:

Vertical reinforcement of at least 0.20 in.^2 (129 mm^2) in cross-sectional area shall be provided continuously from support to support at each corner, at each side of each opening, and at the ends of walls. The reinforcement required by Sec. 22.6.6.5 of ACI 318 shall be provided.

Horizontal reinforcement of at least 0.20 in.^2 (129 mm^2) in cross-sectional area shall be provided:

1. Continuously at structurally connected roof and floor levels and at the top of walls,
2. At the bottom of load-bearing walls or in the top of foundations where doweled to the wall, and
3. At a maximum spacing of 120 in. (3050 mm).

Reinforcement at the top and bottom of openings, where used in determining the maximum spacing specified in Item 3 above, shall be continuous in the wall.

Basement, foundation, or other walls below the base shall be reinforced as required by Sec. 22.6.6.5 of ACI 318.

9.2.1.3 Ordinary precast shear walls. Ordinary precast shear walls shall satisfy the requirements of Sec. 21.1 of ACI 318 for ordinary precast structural walls. See Sec. 9.2.2.1.1.

9.2.1.4 Ordinary reinforced concrete shear walls. Ordinary reinforced concrete shear walls shall satisfy the requirements of Sec. 21.1 of ACI 318 for ordinary reinforced concrete structural walls. See Sec. 9.2.2.1.1.

9.2.1.5 Intermediate precast shear walls. Intermediate precast shear walls shall satisfy the requirements of both Sec. 21.1 of ACI 318 and Sec. 9.2.2.5 for intermediate precast structural walls.

9.2.1.6 Special reinforced concrete shear walls. Special reinforced concrete shear walls shall satisfy the requirements of Sec. 21.1 of ACI 318 for special reinforced concrete structural walls or for special precast structural walls.

9.2.2 Modifications to ACI 318

9.2.2.1 General

9.2.2.1.1 Additional or modified definitions. Add or modify the following definitions in Sec. 21.1 of ACI 318:

Design displacement: Design story drift as specified in Sec. 5.2.6.1 of the 2003 *NEHRP Recommended Provisions*.

Design load combinations: Combinations of factored loads and forces specified in Sec. 9.2 or C.2 where seismic load E is specified in Sec. 4.2.2 of the 2003 *NEHRP Recommended Provisions*.

Ordinary precast structural wall: A wall incorporating precast concrete elements and complying with the requirements of Chapters 1 through 18 with the requirements of Chapter 16 superseding those of Chapter 14.

Ordinary reinforced concrete structural wall: A cast-in-place wall complying with the requirements of Chapters 1 through 18.

Wall pier: A wall segment with a horizontal length-to-thickness ratio of at least 2.5, but not exceeding 6, whose clear height is at least two times its horizontal length.

9.2.2.1.2 Additional notation. Add or modify the following notation in Sec. 21.0 of ACI 318:

Δ_m = $C_d \Delta_s$. Also equal to δ_u of ACI 318.

Δ_s = design level response displacement, which is the total drift or total story drift that occurs when the structure is subjected to the design seismic forces.

9.2.2.1.3 Scope: Delete Sec. 21.2.1.2, 21.2.1.3, and 21.2.1.4 of ACI 318 and replace with the following:

“21.2.1.2 For structures assigned to Seismic Design Category A or B, provisions of Chapters 1 through 18 and 22 shall apply except as modified by the requirements of Chapter 9 of the 2003 *NEHRP Recommended Provisions*. Where the design seismic loads are computed using provisions for intermediate or special concrete systems, the requirements of Chapter 21 for intermediate or special systems, as applicable, shall be satisfied.

“21.2.1.3 For structures assigned to Seismic Design Category C, intermediate or special moment frames, ordinary or special reinforced concrete structural walls, or intermediate or special precast structural walls shall be used to resist seismic forces induced by earthquake motions. Where the design seismic loads are computed using the provisions for intermediate or special concrete systems, the requirements of Chapter 21 for special systems, as applicable, shall be satisfied.

“21.2.1.4 For structures assigned to Seismic Design Category D, E or F, special moment frames, special structural walls, diaphragms, trusses and foundations complying with Sec. 21.2 through 21.10, or intermediate precast structural walls complying with 21.13, shall be used to resist earthquake motions. Frame members not proportioned to resist earthquake forces shall comply with Sec. 21.11.”

9.2.2.1.4. Delete Sec. 21.2 of ACI 318 and replace with following:

“21.2.5 Reinforcement in members resisting earthquake-induced forces.

“21.2.5.1 Deformed reinforcement resisting earthquake-induced flexural and axial forces in the frame members and in structural wall boundary elements shall comply with ASTM A 706. ASTM A 615 Grades 40 and 60 reinforcement shall be permitted in these members if:

“(a) The actual yield strength based on mill tests does not exceed the specified yield strength by more than 18,000 psi (retests shall not exceed this value by more than an additional 3000 psi); and

“(b) The ratio of the actual ultimate tensile strength to the actual tensile yield strength is not less than 1.25.

“**21.2.5.2** Prestressing steel resisting earthquake-induced flexural and axial loads in frame members shall comply with ASTM A 421 or ASTM A 722. The average prestress, f_{pc} , calculated for an area equal to the member’s shortest cross-sectional dimension multiplied by the perpendicular dimension shall not exceed the lesser of 700 psi or $f'_c/6$ at plastic hinge regions.

“ **21.2.9 –Anchorages for post-tensioning tendons.**

“**21.2.9** Anchorages for unbonded post-tensioning tendons resisting earthquake induced forces in structures in regions of moderate or high seismic risk, or assigned to intermediate or high seismic performance or design categories shall withstand, without failure, 50 cycles of loading between 40 and 85 percent of the specified tensile strength of the prestressing steel.”

9.2.2.2 Special moment frames. Add the following new Sec. 21.3.2.5 to ACI 318:

“**21.3.2.5** – Unless the special moment frame is qualified for use through structural testing as required by 21.6.3, for flexural members, prestressing steel shall not provide more than one quarter of the strength for either positive or negative moment at the critical section in a plastic hinge location and shall be anchored at or beyond the exterior face of a joint.”

9.2.2.3 Special reinforced concrete shear walls

9.2.2.3.1. In Sec. 21.7.3 of ACI 318, change “factored load combinations” to “design load combinations.”

9.2.2.3.2. Add a new Sec. 21.7.10 to ACI 318 which reads as follows:

“ **21.7.10 Wall piers and wall segments**

“ **21.7.10.1:** Wall piers not designed as part of a special moment frame shall have transverse reinforcement designed to satisfy the requirements of Sec. 21.7.10.2.

“**Exceptions:** This requirement need not be applied in the following conditions:

“1. Wall piers that satisfy Sec. 21.11, and

“2. Wall piers along a wall line within a story where other shear wall segments provide lateral support to the wall piers and such segments have a total stiffness of at least six times the sum of the stiffness of all the wall piers.

“ **21.7.10.2:** Transverse reinforcement with seismic hooks at both ends shall be designed to resist the shear forces determined from Sec. 21.4.5.1. Spacing of transverse reinforcement shall not exceed 6 in. (152 mm). Transverse reinforcement shall be extended beyond the pier clear height for at least 12 in. (304mm).

“**21.7.10.3** Wall segments with a horizontal length-to-thickness ratio less than 2.5 shall be designed as columns.”

9.2.2.4 Special structural walls constructed using precast concrete . Add a new Sec. 21.8.2 to ACI 318 as follows:

“**21.8.2** Wall systems not meeting the requirements of 21.8.1 shall be permitted if substantiating experimental evidence and analysis meets the requirements of Sec. 9. 6 of the 2003 NEHRP Recommended *Provisions*.”

9.2.2.5 Intermediate precast structural walls. Delete existing Sec. 21.13.3 of ACI 318 and replace with following:

“**21.13.3** Connections that are designed to yield shall be capable of maintaining 80 percent of their design strength at the deformation induced by design displacement, or shall use type 2 mechanical splices.

“**21.13.4** Elements of the connection that are not designed to yield shall develop at least $1.5 S_y$.”

“**21.13.5** Wall piers not designed as part of a moment frame shall have transverse reinforcement designed to resist the shear forces determined from Sec. 21.12.3. Spacing of transverse reinforcement shall not exceed 8 in., and (b) six times the diameter of the longitudinal reinforcement. Transverse reinforcement shall be extended beyond the pier clear height for at least 12 in.

Exception: The above requirement need not apply in the following situations:

1. Wall piers that satisfy Sec. 21.11, and
2. Wall piers along a wall line within a story where other shear wall segments provide lateral support to the wall piers and such segments have a total stiffness of at least six times the sum of the stiffnesses of all the wall piers.

“Wall segments with a horizontal length-to-thickness ratio less than 2.5 shall be designed as columns.”

9.2.2.6 Foundations. Delete Sec. 21.10.1.1 of ACI 318 and replace with following:

“ **21.10.1.1** Foundations resisting earthquake-induced forces or transferring earthquake-induced forces between a structure and the ground shall comply with requirements of 21.10 and other applicable provisions except as modified by Chapter 7 of the 2003 *NEHRP Recommended Provisions*.”

9.2.2.7 Frame members that are not part of the seismic-force-resisting system. Delete Sec.21.11.2.2 of ACI 318 and replace with following:

“ **21.11.2.2** . Members with factored gravity axial forces exceeding $A_g f_c' / 10$ shall satisfy 21.4.3, 21.4.4.1(c), 21.4.4.3, and 21.4.5. The maximum longitudinal spacing of ties shall be s_o for the full column height. The spacing, s_o , shall not be more than six diameters of the smallest longitudinal bar enclosed or 6 in. (152 mm), whichever is smaller. Lap splices of longitudinal reinforcement in such members need not satisfy 21.4.3.2 in structures where the seismic-force-resisting system does not include special moment frames.”

9.2.2.8 Anchoring to Concrete

9.2.2.8.1. Delete Sec. D.3.3.2 of ACI 318 and replace with following:

“**D.3.3.2** – In structures assigned to Seismic Design Category C, D, E or F, post-installed structural anchors for use under D.2.3 shall have passed the Simulated Seismic Tests of ACI 355.2.”

9.2.2.8.2. Delete Sec. D.3.3.3 of ACI 318 and replace with following:

“**D.3.3.3** – In structures assigned to Seismic Design Category C, D, E or F, the design strength of anchors shall be taken as $0.75 \phi N_n$ and $0.75 \phi V_n$, where ϕ is given in D 4.4 when the load combinations of Sec. 9.2 are used and in D 4.5 when the load combinations of Appendix C are used, and N_n and V_n are determined in accordance with D.4.1.”

9.2.2.8.3. Delete Sec. D.3.3.4 of ACI 318 and replace with following:

“**D 3.3.4** – In structures assigned to Seismic Design Category C, D, E or F, anchors shall be designed to be governed by tensile or shear strength of a ductile steel element, unless D.3.3.5 is satisfied.”

9.2.2.8.4. Delete Sec. D 3.3.5 of ACI 318 and replace with following:

“**D 3.3.5** – Instead of D 3.3.4, the attachment that the anchor is connecting to the structure shall be designed so that the attachment undergoes ductile yielding at a load level corresponding to anchor forces no greater than the design strength of anchors specified in D.3.3.3, or the minimum design strength of the anchors shall be at least 2.5 times the factored forces transmitted by the attachment.

9.3 SEISMIC DESIGN CATEGORY B

Structures assigned to Seismic Design Category B shall satisfy the requirements of Sec.21.2.1.2 of ACI 318 and this section.

9.3.1 Ordinary moment frames. Flexural members of all ordinary moment frames forming part of the seismic-force-resisting system shall be designed in accordance with Sec. 7.13.2 of ACI 318. For such elements, at least two main flexural reinforcing bars shall be provided continuously, top and bottom, throughout the beams and shall extend through or be developed within exterior columns or boundary elements.

Columns of ordinary moment frames having a clear-height-to-maximum-plan-dimension ratio of 5 or less shall be designed for shear in accordance with Sec. 21.12.3 of ACI 318.

9.4 SEISMIC DESIGN CATEGORY C

Structures assigned to Seismic Design Category C shall satisfy the requirements for Seismic Design Category B, Sec. 21.2.1.3 of ACI 318 and the additional requirements of this section.

9.4.1 Discontinuous members. Columns supporting reactions from discontinuous stiff members such as walls shall be designed for the seismic load effects defined in Sec. 4.2.2.2 and shall be provided with transverse reinforcement at the spacing s_o as defined in Sec. 2.12.5.2 of ACI 318 over their full height beneath the level at which the discontinuity occurs. This transverse reinforcement shall be extended above and below the column as required in Sec. 21.4.4.5 of ACI 318.

9.4.2 Plain concrete. Plain concrete members shall comply with the requirements of ACI 318 and the additional requirements and limitations of this section.

9.4.2.1 Walls. Ordinary and detailed plain concrete walls are not permitted.

Exception: In detached one- and two-family dwellings three stories or less in height constructed with stud bearing walls, plain concrete basement, foundation, or other walls below the base are permitted. Such walls shall have reinforcement in accordance with Sec. 22.6.6.5 of ACI 318.

9.4.2.2 Footings. Isolated footings of plain concrete supporting pedestals or columns are permitted provided the projection of the footing beyond the face of the supported member does not exceed the footing thickness.

Exception: In detached one- and two-family dwellings three stories or less in height constructed with stud bearing walls, the projection of the footing beyond the face of the supported member shall be permitted to exceed the footing thickness.

Plain concrete footings supporting walls shall be provided with no less than two continuous longitudinal reinforcing bars. Bars shall not be smaller than No. 4 (13 mm) and shall have a total area of not less than 0.002 times the gross cross-sectional area of the footing. For footings that exceed 8 in. in thickness, a minimum of one bar shall be provided at the top and bottom of the footing. For foundation systems consisting of plain concrete footing and plain concrete stemwall, a minimum of one bar shall be provided at the top of the stemwall and at the bottom the footing. Continuity of reinforcement shall be provided at corners and intersections.

Exceptions:

1. In detached one- and two-family dwellings three stories or less in height and constructed with stud bearing walls, plain concrete footings supporting walls shall be permitted without longitudinal reinforcement.
2. Where a slab-on-ground is cast monolithically with the footing, one No. 5 (16 mm) bar is permitted to be located at either the top or bottom of the footing.

9.4.2.3 Pedestals. Plain concrete pedestals shall not be used to resist lateral seismic forces.

9.5 SEISMIC DESIGN CATEGORIES D, E, AND F

Structures assigned to Seismic Design Category D, E, or F shall satisfy the requirements for Seismic Design Category C and Sec. 21.2.1.4 of ACI 318.

9.6 ACCEPTANCE CRITERIA FOR SPECIAL PRECAST STRUCTURAL WALLS BASED ON VALIDATION TESTING**9.6.1 Notation**

Symbols additional to those in Chapter 21 of ACI 318 are defined.

E_{max} = maximum lateral resistance of test module determined from test results (forces or moments).

E_n = nominal lateral resistance of test module calculated using specified geometric properties of test members, specified yield strength of reinforcement, specified compressive strength of concrete, a strain compatibility analysis or deformation compatibility analysis for flexural strength and a strength reduction factor ϕ of 1.0.

E_{nt} = Calculated lateral resistance of test module using the actual geometric properties of test members, the actual strengths of reinforcement, concrete, and coupling devices, obtained by testing per 9.6.7.7, 9.6.7.8, and 9.6.7.9; and a strength reduction factor ϕ of 1.0.

θ = drift ratio.

β = relative energy dissipation ratio.

9.6.2 Definitions

Definitions additional to those in Chapter 21 of ACI 318 are defined.

9.6.2.1 Coupling Elements. Devices or beams connecting adjacent vertical boundaries of structural walls and used to provide stiffness and energy dissipation for the connected assembly greater than the sum of those provided by the connected walls acting as separate units.

9.6.2.2 Drift ratio. Total lateral deformation of the test module divided by the height of the test module.

9.6.2.3 Global toughness. The ability of the entire lateral force resisting system of the prototype structure to maintain structural integrity and continue to carry the required gravity load at the maximum lateral displacements anticipated for the ground motions of the maximum considered earthquake.

9.6.2.4 Prototype structure. The concrete wall structure for which acceptance is sought.

9.6.2.5 Relative energy dissipation ratio. Ratio of actual to ideal energy dissipated by test module during reversed cyclic response between given drift ratio limits, expressed as the ratio of the area of the hysteresis loop for that cycle to the area of the circumscribing parallelograms defined by the initial stiffnesses during the first cycle and the peak resistances during the cycle for which the relative energy dissipation ratio is calculated Sec. 9.6.9.1.3.

9.6.2.5 Test module. Laboratory specimen representing the critical walls of the prototype structure. See 9.6.5.

9.6.3 Scope and general requirements

9.6.3.1 These provisions define minimum acceptance criteria for new precast structural walls, including coupled precast structural walls, designed for regions of high seismic risk or for structures assigned to high seismic performance or design categories, where acceptance is based on experimental evidence and mathematical analysis.

9.6.3.2. These provisions are applicable to precast structural walls, coupled or uncoupled, with height to length, h_w/l_w , ratios equal to or greater than 0.5. These provisions are applicable for either prequalifying precast structural walls for a specific structure or prequalifying a new precast wall type for construction in general.

9.6.3.3. Precast structural walls shall be deemed to have a response that is at least equivalent to the response of monolithic structural walls designed in accordance with Sec.21.2 and 21.7 of ACI 318, and the corresponding structural walls of the prototype structure shall be deemed acceptable, when all of the conditions in Sec. 9.6.3.3.1 through 9.6.3.3.5 are satisfied.

9.6.3.3.1. The prototype structure satisfies all applicable requirements of these provisions and of ACI 318 except Sec.21.7.

9.6.3.3.2. Tests on wall modules satisfy the conditions in Sec. 9.6.4 and 9.6.9.

9.6.3.3.3. The prototype structure is designed using the design procedure substantiated by the testing program.

9.6.3.3.4. The prototype structure is designed and analyzed using effective initial properties consistent with those determined in accordance with Sec. 9.6.7.11, and the prototype structure meets the drift limits of these provisions.

9.6.3.3.5. The structure as a whole, based on the results of the tests of Sec. 9.6.3.3.2 and analysis, is demonstrated to have adequate global toughness (the ability to retain its structural integrity and support its specified gravity loads) through peak displacements equal to or exceeding the story-drift ratios specified in Sec.9.6.7.4, 9.6.7.5 or 9.6.7.6, as appropriate.

9.6.4 Design procedure

9.6.4.1. Prior to testing, a design procedure shall be developed for the prototype structure and its walls. That procedure shall account for effects of material non-linearity, including cracking, deformations of members and connections, and reversed cyclic loading. The design procedure shall include the procedures specified in Sec. 9.6.4.1.1 through 9.6.4.1.4 and shall be applicable to all precast structural walls, coupled and uncoupled, of the prototype structure.

9.6.4.1.1. Procedures shall be specified for calculating the effective initial stiffness of the precast structural walls, and of coupled structural walls, that are applicable to all the walls of the prototype structure.

9.6.4.1.2. Procedures shall be specified for calculating the lateral strength of the precast structural walls, and of coupled structural walls, applicable to all precast walls of the prototype structure.

9.6.4.1.3. Procedures shall be specified for designing and detailing the precast structural walls so that they have adequate ductility capacity. These procedures shall cover wall shear strength, sliding shear strength, boundary tie spacing to prevent bar buckling, concrete confinement, reinforcement strain, and any other actions or elements of the wall system that can affect ductility capacity.

9.6.4.1.4. Procedures shall be specified for determining that an undesirable mechanism of nonlinear response, such as a story mechanism due to local buckling of the reinforcement or splice failure, or overall instability of the wall, does not occur.

9.6.4.2. The design procedure shall be used to design the test modules and shall be documented in the test report.

9.6.4.3. The design procedure used to proportion the test specimens shall define the mechanism by which the system resists gravity and earthquake effects and shall establish acceptance values for sustaining that mechanism. Portions of the mechanism that deviate from code requirements shall be contained in the test specimens and shall be tested to determine acceptance values.

9.6.5 Test Modules

9.6.5.1. At least two modules shall be tested. At least one module shall be tested for each limiting engineering design criteria (shear, axial load and flexure) for each characteristic configuration of precast structural walls, including intersecting structural walls or coupled structural walls. If all the precast walls of the structure have the same configuration and the same limiting engineering design criterion, then two modules shall be tested. Where intersecting precast wall systems are to be used, the response for the two orthogonal directions shall be tested.

9.6.5.2. Where the design requires the use of coupling elements, those elements shall be included as part of the test module.

9.6.5.3. Modules shall have a scale large enough to represent the complexities and behavior of the real materials and of the load transfer mechanisms in the prototype walls and their coupling elements, if any. Modules shall have a scale not less than one half and shall be full-scale if the validation testing has not been preceded by an extensive analytical and experimental development program in which critical details of connections are tested at full scale.

9.6.5.4. The geometry, reinforcing details, and materials properties of the walls, connections, and coupling elements shall be representative of those to be used in the prototype structure.

9.6.5.5. Walls shall be at least two panels high unless the prototype structure is one for which a single panel is to be used for the full height of the wall.

9.6.5.6. Where precast walls are to be used for bearing wall structures, as defined in SEI/ASCE 7-02, the test modules shall be subject during lateral loading to an axial load stress representative of that anticipated at the base of the wall in the prototype structure.

9.6.5.7. The geometry, reinforcing, and details used to connect the precast walls to the foundation shall replicate those to be used in the prototype structure.

9.6.5.8. Foundations used to support the test modules shall have geometric characteristics, and shall be reinforced and supported, so that their deformations and cracking do not affect the performance of the modules in a way that would be different than in the prototype structure.

9.6.6 Testing Agency. Testing shall be carried out by an independent testing agency approved by the Authority Having Jurisdiction. The testing agency shall perform its work under the supervision of a registered design professional experienced in seismic structural design.

9.6.7 Test Method

9.6.7.1 Test modules shall be subjected to a sequence of displacement-controlled cycles representative of the drifts expected under earthquake motions for the prototype structure. If the module consists of coupled walls, approximately equal drifts (within 5 percent of each other) shall be applied to the top of each wall and at each floor level. Cycles shall be to predetermined drift ratios as defined in Sec. 9.6.7.2 through 9.6.7.6.

9.6.7.2 Three fully reversed cycles shall be applied at each drift ratio.

9.6.7.3 The initial drift ratio shall be within the essentially linear elastic response range for the module. See 9.6.7.11. Subsequent drift ratios shall be to values not less than 5/4 times, and not more than 3/2 times, the previous drift ratio.

9.6.7.4 For uncoupled walls, testing shall continue with gradually increasing drift ratios until the drift ratio in percent equals or exceeds the larger of : (a) 1.5 times the drift ratio corresponding to the design

displacement or (b) the following value:

$$0.80 \leq 0.67 \left[h_w / l_w \right] + 0.5 \leq 2.5 \quad (9.6-1)$$

where:

h_w = height of entire wall for prototype structure, in.

l_w = length of entire wall in direction of shear force, in.

9.6.7.5 For coupled walls, h_w/l_w in Eq. 9.6.1 shall be taken as the smallest value of h_w/l_w for any individual wall of the prototype structure.

9.6.7.6 Validation by testing to limiting drift ratios less than those given by Eq. 9.6.1 shall be acceptable provided testing is conducted in accordance with this document to drift ratios equal or exceeding of those determined for the response to a suite of nonlinear time history analyses conducted in accordance with Sec. 9.5.8 of SEI/ASCE 7-02 for maximum considered ground motions.

9.6.7.7 Actual yield strength of steel reinforcement shall be obtained by testing coupons taken from the same reinforcement batch as used in the test module. Two tests, conforming to the ASTM specifications cited in Sec. 3.5 of ACI 318, shall be made for each reinforcement type and size.

9.6.7.8 Actual compressive strength of concrete shall be determined by testing of concrete cylinders cured under the same conditions as the test module and tested at the time of testing the module. Testing shall conform to the applicable requirements of Sec.5.6.1 through 5.6.4 of ACI 318.

9.6.7.9 Where strength and deformation capacity of coupling devices does not depend on reinforcement tested as required in Sec. 9.6.7.7, the effective yield strength and deformation capacity of coupling devices shall be obtained by testing independent of the module testing.

9.6.7.10 Data shall be recorded from all tests such that a quantitative interpretation can be made of the performance of the modules. A continuous record shall be made of test module drift ratio versus applied lateral force, and photographs shall be taken that show the condition of the test module at the peak displacement and after each key testing cycle.

9.6.7.11 The effective initial stiffness of the test module shall be calculated based on test cycles to a force between $0.6E_{nt}$ and $0.9E_{nt}$, and using the deformation at the strength of $0.75E_{nt}$ to establish the stiffness.

9.6.8. Test Report

9.6.8.1 The test report shall contain sufficient evidence for an independent evaluation of all test procedures, design assumptions, and the performance of the test modules. As a minimum, all of the information required by Sec. 9.6.8.1.1 through 9.6.8.1.11 shall be provided.

9.6.8.1.1 A description shall be provided of the design procedure and theory used to predict test module strength, specifically the test module nominal lateral resistance, E_n , and the test module actual lateral resistance E_m .

9.6.8.1.2 Details shall be provided of test module design and construction, including fully dimensioned engineering drawings that show all components of the test specimen.

9.6.8.1.3 Details shall be provided of specified material properties used for design, and actual material properties obtained by testing in accordance with Sec. 9.6.7.7.

9.6.8.1.4 A description shall be provided of test setup, including fully dimensioned diagrams and photographs.

9.6.8.1.5 A description shall be provided of instrumentation, its locations, and its purpose.

9.6.8.1.6 A description and graphical presentation shall be provided of applied drift ratio sequence.

9.6.8.1.7 A description shall be provided of observed performance, including photographic documentation, of the condition of each test module at key drift ratios including, (as applicable), the ratios corresponding to first flexural cracking or joint opening, first shear cracking, and first crushing of the concrete for both positive and negative loading directions, and any other significant damage events that occur. Photos shall be taken at peak drifts and after the release of load.

9.6.8.1.8 A graphical presentation shall be provided of lateral force versus drift ratio response.

9.6.8.1.9 A graphical presentation shall be provided of relative energy dissipation ratio versus drift ratio.

9.6.8.1.10 A calculation shall be provided of effective initial stiffness for each test module as observed in the test and as determined in accordance with Sec. 9.6.7.11 and a comparison made as to how accurately the design procedure has been able to predict the measured stiffness. The design procedure shall be used to predict the overall structural response and a comparison made as to how accurately that procedure has been able to predict the measured response.

9.6.8.1.11 The test date, report date, name of testing agency, report author(s), supervising registered design professional, and test sponsor shall be provided.

9.6.9 Test module acceptance criteria

9.6.9.1 The test module shall be deemed to have performed satisfactorily when all of the criteria Sec. 9.6.9.1.1 through 9.6.9.1.3 are met for both directions of in-plane response. If any test module fails to pass the validation testing required by these provisions for any test direction, then the wall system has failed the validation testing.

9.6.9.1.1 Peak lateral strength obtained shall be at least $0.9E_{nt}$ and not greater than $1.2 E_{nt}$.

9.6.9.1.2 In cycling up to the drift level given by Sec. 9.6.7.4 through 9.6.7.6, fracture of reinforcement or coupling elements, or other significant strength degradation, shall not occur. For a given direction, peak lateral strength during any cycle of testing to increasing displacement shall not be less than 0.8 times E_{max} for that direction.

9.6.9.1.3 For cycling at the given drift level for which acceptance is sought in accordance with Sec. 9.6.7.4, 9.6.7.5 or 9.6.7.6, as applicable, the parameters describing the third complete cycle shall have satisfied the following:

1. The relative energy dissipation ratio shall have been not less than 1/8; and
2. The secant stiffness between drift ratios of -1/10 and +1/10 of the maximum applied drift shall have been not less than 0.10 times the stiffness for the initial drift ratio specified in Sec. 9.6.7.3.

9.6.10. Reference

Minimum Design Loads on Buildings and Other Structures Standards Committee, "Minimum Design Loads for Buildings and Other Structures (SEI/ASCE 7-02) - Earthquake Loads," Structural Engineering Institute, American Society of Civil Engineers, Reston, VA, 2002.

This page is intentionally left blank.

Appendix to Chapter 9

UNTOPPED PRECAST DIAPHRAGMS

PREFACE: Reinforced concrete diaphragms constructed using untopped precast concrete elements are permitted in the text of the *Provisions* for Seismic Design Categories A, B, and C but not for Categories D, E, and F. For the latter, the precast elements must be topped and the topping designed as the diaphragm. For resisting seismic forces, a composite topping slab cast in place on precast concrete elements must have a thickness of not less than 2 in. (51 mm) and a topping slab not relying on composite action with the precast elements must have a thickness of not less than 2-1/2 in. (64 mm).

There are two principal reasons why a framework for the design of untopped diaphragms for Seismic Design Categories D, E, and F may be desirable. One relates to the performance of topping slab diaphragms in recent earthquakes and the other to durability considerations. The 1997 *Provisions* incorporated ACI 318-95 for which the provisions for topping slab diaphragms on precast elements were essentially the same as those in ACI 318-89. In the 1994 Northridge earthquake, performance was poor for structures where demands on the topping slab diaphragms on precast elements were maximized and the structures had been designed using ACI 318-89. The topping cracked along the edges of the precast elements and the welded wire reinforcement crossing those cracks fractured. The diaphragms became the equivalent of an untopped diaphragm with the connections between precast concrete elements, the connectors, and the chords not detailed for that condition. Another problem found with topping slab diaphragms was that the chords often utilized large diameter bars, grouped closely together at the topping slab edge. Under severe loading, these unconfined chord bars lost bond with the concrete and thus lost the ability to transfer seismic forces.

ACI 318-99 was significantly revised for structural diaphragms to add new detailing provisions in response to the poor performance of some cast-in-place composite topping slab diaphragms during the 1994 Northridge earthquake. New code and commentary sections 21.7 and R21.7 were added to Chapter 21. Cast-in-place composite topping slabs and cast-in-place topping slab diaphragms were permitted by ACI 318-99, but no mention was made of untopped precast diaphragms. The diaphragm provisions of ACI 318-99 were carried over unchanged into ACI 318-02 and placed in Sec. 21.9 rather than Sec. 21.7, where they had been in ACI 318-99.

The evidence from the recently completed PRESSS 5-story building test (M. J. NM. Priestley, D. Sritharan, J. R. Conley, and S. Pampanin, "Preliminary Results and Conclusions from the PRESSS Five-Story Precast Concrete Test Building," *PCI Journal*, Vol. 44, No. 6, November-December 1999), from Italian and English tests (K. S. Elliott, G. Davies, and W. Omar, "Experimental Hollow-cored Slabs Used as Horizontal Floor Diaphragms," *The Structural Engineer*, Vol. 70, No. 10, May 1992, pp. 175-187; M. Menegotto, "Seismic Diaphragm Behavior of Untopped Hollow-Core Floors," *Proceedings, FIP Congress*, Washington, D. C., May 1994), and from the 1999 Turkey earthquake is that such diaphragms can perform satisfactorily if they are properly detailed and if they and their connections remain elastic under the force levels the diaphragms experience. However, further additions to the ACI 318-02 requirements are needed if such performance is to be achieved. In particular, the diaphragm design forces and detailing requirements for ductility of connections (as a second line of defense) require revision.

These *Provisions* incorporate ACI 318-02, which recognizes that for topping slab diaphragms a controlling condition is the in-plane shear in concrete along the edges of the precast elements. Ductility is provided by requiring that the topping slab reinforcement crossing those edges be spaced at not less than 10 inches on center. While those requirements are based on the best

available engineering judgment and evidence, they have not as yet been proven to provide adequate safety either by laboratory testing or field performance. Due to the dimensions of the precast element relative to the thickness of the topping slab, it may well be prudent to have seismic provisions for diaphragms incorporating precast elements controlled by untopped diaphragm considerations and to have those provisions modified for topped diaphragms. Further, in geographic areas where corrosive environments are a significant concern, the construction of untopped diaphragms using “pre-topped” precast elements rather than topped elements, can be desirable.

This appendix provides a compilation of current engineering judgment on a framework for seismic provisions for untopped diaphragms. That framework does not, however, adequately address all the concerns needed for its incorporation into the text of the *Provisions*. This appendix proposes that a diaphragm composed of untopped elements be designed to remain elastic, and that the connectors be designed for limited ductility, in the event that design forces are exceeded during earthquake response and some inelastic action occurs where the demands on the diaphragm are maximized. By contrast, for all other systems assigned to Seismic Design Category D, E, or F, the philosophy of the *Provisions* is to require significant ductility. For the approach of this appendix, critical issues are how best to define:

The design forces for the diaphragm so that they are large enough to result in essentially elastic behavior when the demands on the diaphragm are maximized, or whether that criterion is even achievable;

1. The relation between the response of the diaphragm, its dimensions, and the ductility demands on the connectors;
2. The ductility changes that occur for connectors under various combinations of in-plane and out-of-plane shear forces, and tensile and compressive forces;
3. The boundary conditions necessary for testing and for application of the loading for the validation testing of connectors; and
4. The constraints on connector performance imposed by their size relative to the size of the diaphragm elements.

The use of this appendix as a framework for laboratory testing, analyses of the performance of diaphragms in past earthquakes, analytical studies, and trial designs is encouraged. Users should also consult the *Commentary* for guidance and references. Please direct all feedback on this appendix and its commentary to the BSSC.

In this appendix, the untopped precast diaphragm is designed to remain elastic by requiring that its design forces be based on Eq. 4.6-2, and be not less than a minimum value dependent upon the seismic response coefficient, with both values multiplied by the overstrength and redundancy factors associated with the seismic-force-resisting system. In addition, the connections are required to be able to perform in a ductile manner in the unlikely event that the diaphragm is forced to deform inelastically.

A9.1 GENERAL

A9.1.1 Scope. This appendix provides guidelines for the design of diaphragms using untopped precast concrete elements for Seismic Design Categories D, E, and F.

A9.1.2 References

- | | |
|-------------|---|
| ACI 318 | <i>Building Code Requirements for Structural Concrete</i> , American Concrete Institute, 2002 |
| ACI T1.1-01 | <i>Acceptance Criteria for Moment Frames Based on Structural Testing</i> , American Concrete Institute, 2001. |

ATC-24 *Guidelines for Seismic Testing of Components of Steel Structures*, Applied Technology Council, 1992.

A9.1.3 Definitions

Boundary elements: See Sec. 2.1.3.

Chord: See Sec. 12.1.3.

Collector: See Sec. 4.1.3.

Component: See Sec. 1.1.4.

Design strength: See Sec. 4.1.3.

Diaphragm: See Sec. 4.1.3.

Drag strut: See Sec. 4.1.3.

Nominal strength: See Sec. 4.1.3.

Quality assurance plan: See Sec. 2.1.3.

Required strength: See Sec. 4.1.3.

Seismic Design Category: See Sec. 1.1.4.

Seismic-force-resisting system: See Sec. 1.1.4.

Structure: See Sec. 1.1.4.

Untopped precast diaphragm: A diaphragm consisting of precast concrete components that does not have a structural topping meeting the requirements of these *Provisions*.

A9.1.4 Notation.

C_S See Sec. 5.1.3.

F_{px} See Sec. 4.1.4.

w_{px} See Sec. 4.1.4.

ρ See Sec. 4.1.4.

ϕ See Sec. 5.1.3.

Ω_0 See Sec. 4.1.4.

A9.2 DESIGN REQUIREMENTS

Untopped precast floor or roof diaphragms in Seismic Design Category D, E, or F shall satisfy the requirements of this section.

A9.2.1 Configuration. Untopped diaphragms shall not be permitted in structures with plan irregularity Type 4 as defined in Table 4.3-2. For diaphragms in structures having plan irregularities Type 1a, 1b, 2, or 5 as defined in Table 4.3-2, the analysis required by Sec. A9.2.2 shall explicitly include the effect of such irregularities as required by Sec. 4.6.

A9.2.2 Diaphragm demand. Rational elastic models shall be used to determine the in-plane shear, tension, and compression forces acting on connections that cross joints. For any given joint, the connections shall resist the total shear and total moment acting on the joint assuming an elastic distribution of stresses.

The diaphragm design force shall be taken as the lesser of the following two criteria:

1. $\rho\Omega_0$ times the F_{px} value calculated from Eq. 4.6-2, but not less than $\rho\Omega_0 C_S w_{px}$; or
2. A shear force corresponding to 1.25 times that corresponding to yielding of the seismic-force-

resisting system, calculated using ϕ value(s) equal to unity.

In item 1 above, the overstrength factor, Ω_o , shall be that for the seismic-force-resisting system as specified in Table 4.3-1, the redundancy factor, ρ , shall be as specified in *Provisions* Sec. 4.3.3, and the seismic response coefficient, C_s , shall be as determined in accordance with *Provisions* Sec. 5.2.1.1.

A9.2.3 Mechanical connections. Mechanical connections shall have design strength, for the body of the connector, greater than the factored forces determined in accordance with Sec. A9.2.2.

Mechanical connections used at joints shall be shown by analysis and testing, under reversed cyclic loading, to develop adequate capacity in shear, tension, and compression (or a combination of these effects) to resist the demands calculated in accordance with Sec. A9.2.2. Testing of connections and evaluation of results shall be made in accordance with the principles specified in ACI T1.1 and ATC-24.

When subjected to the specified loading, connections shall develop ductility ratios equal to or greater than 2.0. The behavior of connection embedments shall be governed by steel yielding and not by fracture of concrete or welds.

Connections shall be designed using the strength reduction factors, ϕ , specified in ACI 318. Where the ϕ factor is modified by Sec. 9.3.4 of ACI 318, the modified value shall be used for the diaphragm connections.

Where the design relies on friction in grouted joints for shear transfer across the joints, shear friction resistance shall be provided by mechanical connectors or reinforcement.

A9.2.4 Cast-in-place strips. Cast-in place strips shall be permitted in the end or edge regions of precast components as chords or collectors. These strips shall meet the requirements for topping slab diaphragms. The reinforcement in the strips shall comply with Sec. 21.9.8.2 and 21.9.8.3 of ACI 318.

A9.2.5 Deformation compatibility. In satisfying the compatibility requirement of Sec. 4.5.3, the additional deformation that results from the diaphragm flexibility shall be considered. The assumed flexural and shear stiffness properties of the elements that are part of the seismic-force-resisting system shall not exceed one-half of the gross-section properties, unless confirmed by a rational, cracked-section analysis.

A9.2.6 Beam connections. Ties to supporting members and bearing lengths shall satisfy the requirements for design force and geometry characteristics specified for the connections in Sec. 21.11.4 of ACI 318.

A9.2.7 Quality assurance. Diaphragms shall have a quality assurance plan in accordance with Sec. 2.2.1 of these *Provisions*.

Chapter 10

COMPOSITE STEEL AND CONCRETE STRUCTURE DESIGN REQUIREMENTS

10.1 GENERAL

10.1.1 Scope. The design, construction, and quality of composite steel and concrete components that resist seismic forces shall comply with the requirements of the references in Sec. 10.1.2 and the additional requirements of this chapter.

10.1.2 References. The following documents shall be used as specified in this chapter.

ACI 318 *Building Code Requirements for Structural Concrete*, American Concrete Institute, 2002, excluding Appendix C (Alternative Load and Strength Reduction Factors) and Chapter 22 (Structural Plain Concrete).

AISC LRFD *Load and Resistance Factor Design Specification for Structural Steel Buildings*, American Institute of Steel Construction, 1999.

AISC Seismic *Seismic Provisions for Structural Steel Buildings*, Parts I and II, American Institute of Steel Construction, 2002.

10.1.3 Definitions

Seismic Design Category: See Sec. 1.1.4.

Structure: See Sec. 1.1.4.

10.1.4 Notation

R See Sec. 4.1.4.

10.2 GENERAL DESIGN REQUIREMENTS

An *R* factor as set forth in Table 4.3-1 for the appropriate composite steel and concrete system is permitted when the structure is designed and detailed in accordance with the provisions of AISC Seismic, Part II.

10.3 SEISMIC DESIGN CATEGORIES B AND C

For structures assigned to Seismic Design Category B or C, the design of such systems shall comply with the requirements of AISC Seismic, Part II.

10.4 SEISMIC DESIGN CATEGORIES D, E, AND F

Composite structures assigned to Seismic Design Category D, E, or F are permitted, subject to the limitations in Table 4.3-1, where substantiating evidence is provided to demonstrate that the proposed system will perform as intended by AISC Seismic, Part II. The substantiating evidence shall be subject to approval by the authority having jurisdiction. Where composite elements or connections are required to sustain inelastic deformations, the substantiating evidence shall be based upon cyclic testing.

10.5 MODIFICATIONS TO AISC SEISMIC, PART II

10.5.1 Changes to nomenclature. Change throughout the document “Seismic Force Resisting System” to “Seismic Load Resisting System.”

10.5.2 Changes to definitions in the AISC Glossary.

“Composite Beam. A structural steel beam that is in contact with and acts compositely with reinforced concrete via bond or shear connectors.

Encased Composite Beam. A composite beam that is completely enclosed in reinforced concrete.

Unencased Composite Beam. A composite beam wherein the steel section is not completely enclosed in reinforced concrete and relies on mechanical connectors for composite action with a reinforced slab or slab on metal deck.”

10.5.3 Changes to Section 1 - SCOPE

“These Provisions shall be applied in conjunction with the AISC *Load and Resistance Factor Design (LRFD) Specification for Structural Steel Buildings*, hereinafter referred to as the LRFD Specification. The applicable requirements in Part I shall be used for the design of structural steel components in composite Seismic Load Resisting Systems. The applicable requirements in ACI 318 shall be used for the design of reinforced concrete components in composite Seismic Load Resisting Systems, except as modified in these provisions. The applicable requirements in Part II shall be used for the design of composite components in composite Seismic Load Resisting Systems. When the design is based upon elastic analysis, the stiffness properties of the component members of composite systems shall reflect their condition at the onset of significant yielding of the building.”

10.5.4 Changes to Section 2 - REFERENCED SPECIFICATIONS, CODES AND STANDARDS

“The documents referenced in these provisions shall include those listed in Part I, Section 2, with the following additions and modifications:

American Society of Civil Engineers, *Standard for the Structural Design of Composite Slabs*, ASCE 3-91

American Welding Society, AWS D1.4-98 – *Standard for the Welding of Reinforcement*”

10.5.5 Changes to Section 3 - SEISMIC DESIGN CATEGORIES

“The required strength and other seismic provisions for Seismic Design Categories (SDCs), Seismic Use Groups or Seismic Zones and the limitations on height and irregularity shall be as specified in the Applicable Building Code (see Glossary).

10.5.6 Changes to Section 4 - LOADS, LOAD COMBINATIONS AND NOMINAL STRENGTHS

“The loads and load combinations shall be as stipulated by the Applicable Building Code. Where Amplified Seismic Loads are required by these provisions, the horizontal earthquake load E (as defined in the Applicable Building Code) shall be multiplied by the overstrength factor Ω_0 prescribed by the Applicable Building Code. In the absence of a specific...”

10.5.7 Changes to Section 5.2 - Concrete and Steel Reinforcement

“Concrete and steel reinforcement used in composite components in composite Seismic Load Resisting Systems shall meet the requirements in ACI 318, Sections 25.4 through 25.8.

Exception: Concrete and steel reinforcement used in the composite Ordinary Seismic Load Resisting Systems described in Sections 11, 12, and 15 shall meet the requirements in AISC LRFD Chapter I and ACI 318, excluding Chapter 21.”

10.5.8 Changes to Section 6.3 - COMPOSITE BEAMS

“Composite Beams shall meet the requirements in LRFD Specification Chapter I. Composite Beams that are part of C-SMF shall also meet the requirements of Section 9.3.”

10.5.9 Changes to Section 6.4 - Reinforced-Concrete-Encased Composite Columns

“This Section is applicable to columns that meet the limitations in LRFD Specification Section I2.1.

Such columns shall meet the requirements in LRFD Specification Chapter I, except as modified in this Section. Additional requirements, as specified for intermediate and special seismic systems in Sections 6.4b and 6.4c, shall apply as required in the descriptions of the composite seismic systems in Sections 8 through 17.

Columns that consist of reinforced-concrete-encased structural steel sections shall meet the requirements for reinforced concrete columns in ACI 318 except as modified for:

- (1) The steel shape shear connectors in Section 6.4a.2
- (2) The contribution of the reinforced-concrete-encased structural steel section to the strength of the column as provided in ACI 318.
- (3) The seismic requirements for reinforced concrete columns as specified in the description of the composite seismic systems in Sections 8 through 17.”

10.5.10 Changes to Section 6.4a - Ordinary Seismic System Requirements

“(5)Splices and end bearing details for reinforced-concrete-encased composite columns in ordinary systems shall meet the requirements in the LRFD Specification and ACI 318 Section 7.8.2. The design for intermediate and special systems shall also comply with ACI 318-02 Sections 21.2.6-7 and 21.10. The design shall consider any adverse behavioral effects due to abrupt changes in either the member stiffness or nominal tensile strength. Such locations shall include transitions to reinforced concrete sections without embedded structural steel members, transitions to bare structural steel sections, and column bases.”

10.5.11 Changes to Section 6.5 - CONCRETE-FILLED COMPOSITE COLUMNS

“This Section is applicable to columns that meet the limitations in LRFD Specification Section I2.1. Such columns shall be designed to meet the requirements in LRFD Specification Chapter I, except as modified in this Section.

6.5a. The design shear strength of the composite column shall be the design shear strength of the structural steel section alone.

6.5b. In addition to the requirements in Section 6.5a, in the special seismic systems described in Sections 9, 13 and 14, the design forces and column splices for concrete-filled composite columns shall also meet the requirements in Part I Section 8.

6.5c. Concrete-filled composite columns used in C-SMF shall meet the following requirements in addition to those in Sections 6.5a. and 6.5b:

1. The minimum required shear strength of the column shall meet the requirements in ACI 318 Section 21.4.5.1.
2. The strong-column/weak-beam design requirements in Section 9.5 shall be met. Column bases shall be designed to sustain inelastic flexural hinging
3. The minimum wall thickness of concrete-filled rectangular HSS shall equal

$$b\sqrt{F_y/(2E_s)} \quad (6-3)$$

for the flat width b of each face, where b is as defined in LRFD Specification Table B5.1, unless adequate means to prevent local buckling of the steel shape is demonstrated by tests or analysis.”

10.5.12 Changes to Section 6.5a - CONCRETE-FILLED COMPOSITE COLUMNS

“**6.5a.** The design shear strength of the composite column shall be the design shear strength of the structural steel section alone, based on its effective shear area. The concrete shear capacity may be used in conjunction the shear strength from the steel shape provided the design includes an appropriate load transferring mechanism. “

10.5.13 Changes to Section 7.3 - **NOMINAL STRENGTH OF CONNECTIONS**

“The nominal strength of connections in composite structural systems shall be determined on the basis of rational models that satisfy both equilibrium of internal forces and the strength limitation of component materials and elements based upon potential limit states. Unless the connection strength is determined by analysis and testing, the models used for analysis of connections shall meet the requirements in Sections 7.3a through 7.3e.

7.3a. When required, force shall be transferred between structural steel and reinforced concrete through direct bearing of headed shear studs or suitable alternative devices, by other mechanical means, by shear friction with the necessary clamping force provided by reinforcement normal to the plane of shear transfer, or by a combination of these means. Any potential bond strength between structural steel and reinforced concrete shall be ignored for the purpose of the connection force transfer mechanism. The contribution of different mechanism can be combined only if the stiffness and deformation capacity of the mechanisms is compatible.

The nominal bearing and shear-friction strengths shall meet the requirements in ACI 318 Chapters 10 and 11.

7.3b. The required strength of structural steel components in composite connections shall not exceed the design strengths as determined in Part I and the LRFD Specification. Structural steel elements that are encased in confined reinforced concrete are permitted to be considered to be braced against out-of-plane buckling. Face Bearing Plates consisting of stiffeners between the flanges of steel beams are required when beams are embedded in reinforced concrete columns or walls unless tests or analysis demonstrates otherwise.

7.3c. The nominal shear strength of reinforced-concrete-encased steel panel-zones in beam-to-column connections shall be calculated as the sum of the nominal strengths of the structural steel and confined reinforced concrete shear elements as determined in Part I Section 9.3 and ACI 318 Section 21.5, respectively.

7.3d. Reinforcement shall be provided to resist all tensile forces in reinforced concrete components of the connections. Additionally, the concrete shall be confined with transverse reinforcement. All reinforcement shall be fully developed in tension or compression, as appropriate, beyond the point at which it is no longer required to resist the forces. Development lengths shall be determined in accordance with ACI 318 Chapter 12. Additionally, development lengths for the systems described in Sections 9, 13, 14, 16 and 17 shall meet the requirements in ACI 318 Section 21.5.4. Connections shall meet the following additional requirements:

1. When the slab transfers horizontal diaphragm forces, the slab reinforcement shall be designed and anchored to carry the in-plane tensile forces at all critical sections in the slab, including connections to collector beams, columns, braces and walls.
2. For connections between structural steel or composite beams and reinforced concrete or reinforced-concrete-encased composite columns, transverse hoop reinforcement shall be provided in the connection region to meet the requirements in ACI 318 Section 21.5, except for the following modifications:
 - a. Structural steel sections framing into the connections are considered to provide confinement over a width equal to that of face bearing stiffener plates welded to the beams between the flanges.
 - b. Lap splices are permitted for perimeter ties when confinement of the splice is provided by Face Bearing Plates or other means that prevents spalling of the concrete cover in the systems described in Sections 10, 11, 12 and 15.
3. The longitudinal bar sizes and layout in reinforced concrete and composite columns shall be detailed to minimize slippage of the bars through the beam-to-column connection due to high force transfer associated with the change in column moments over the height of the connection.”

10.5.14 Changes to Section 8.2 - COLUMNS

“Structural steel columns shall meet the requirements in Part I Section 8 and the LRFD Specification.”

10.5.15 Changes to Section 8.3 - COMPOSITE BEAMS

“Composite beams shall be unencased, fully composite, and shall meet the requirements in LRFD Specification Chapter I, *except I.2*. For the purposes of frame analysis, the stiffness of beams shall be determined with an effective moment of inertia of the composite section that accounts for the negative and positive moments along the composite beams.”

10.5.16 Changes to Section 8.4 - Partially Restrained (PR) Moment Connections

“The required strength for the beam-to-column PR moment connections shall be determined using strength load combinations considering the effects of connection flexibility and second-order moments. In addition, composite connections shall have a nominal strength that is at least equal to 50 percent of $R_y M_p$, where M_p is the nominal plastic flexural strength of the connected structural steel beam ignoring composite action. Connections shall meet the requirements in Section 7 and shall have a minimum inelastic interstory drift angle of 0.025 radians and a total interstory drift angle of 0.04 radians that is substantiated by cyclic testing as described in Part I Section 9.2a.”

10.5.17 Changes to Section 9.3 - BEAMS

“Composite beams that are part of C-SMF as described in Section 9 shall also meet the following requirements:

1. The distance from the maximum concrete compression fiber to the plastic neutral axis shall not exceed:

$$\frac{Y_{con} + d_b}{1 + \left(\frac{1700F_y}{E_s} \right)}$$

where

Y_{con} = distance from the top of the steel beam to the top of concrete, in.

d_b = depth of the steel beam, in.

F_y = specified minimum yield strength of the steel beam, ksi.

E_s = elastic modulus of the steel beam, ksi.

2. Beam flanges shall meet the requirements in Part I Section 9.4, except when fully reinforced-concrete-encased compression elements have a reinforced concrete cover of at least 2 in. and confinement is provided by hoop reinforcement in regions where plastic hinges are expected to occur under seismic deformations. Hoop reinforcement shall meet the requirements in ACI 318 Section 21.3.3.

Neither structural steel nor composite trusses are permitted as flexural members to resist seismic loads in C-SMF unless it is demonstrated by testing and analysis that the particular system provides adequate ductility and energy dissipation capacity.”

10.5.18 Changes to Section 9.4 - MOMENT CONNECTIONS

“The required strength of beam-to-column moment connections shall be determined from the shear and flexure associated with the expected plastic flexural strength, $R_y M_n$, of the beams framing into the connection. The nominal connection strength shall meet the requirements in Section 7. In addition, the connections shall be capable of sustaining a minimum inelastic interstory drift angle of 0.025 radians and a total interstory drift angle of 0.04 radians. When the beam flanges are interrupted at the

connection, the inelastic rotation capacity shall be demonstrated as specified in Part I Section 9 for connections in SMF. For connections to reinforced concrete columns with a beam that is continuous through the column so that welded joints are not required in the flanges and the connection is not otherwise susceptible to premature fractures, the inelastic rotation capacity shall be demonstrated by testing or other substantiating data.”

10.5.19 Changes to Section 9.5 - COLUMN-BEAM MOMENT RATIO

“The minimum flexural strength of reinforced concrete columns shall meet the requirements in ACI 318 Section 21.4.2. The column-to-beam moment ratio of composite columns shall meet the requirements in Part I Section 9.6 with the following modifications:

1. The flexural strength of the composite column M_{pc}^* shall meet the requirements in LRFD Specification Chapter I with consideration of the applied axial load, P_u .
2. The force limit for the exceptions in Part I Section 9.6a shall be $P_u < 0.1P_o$.
3. Composite columns exempted by Part I Section 9.6 shall have transverse reinforcement that meets the requirements in Section 6.4c.3.”

10.5.20 Changes to Section 10.2 - COLUMNS

“Composite columns shall meet the requirements for intermediate seismic systems in Section 6.4 or 6.5. Reinforced concrete columns shall meet the requirements in ACI 318 Section 21.12.”

10.5.21 Changes to Section 10.4 - MOMENT CONNECTIONS

“10.4 Beam-to-Column Moment Connections

The nominal connection strength shall meet the requirements in Section 7. The required strength of beam-to-column connections shall meet the following requirements:

- a. The connection design strength shall meet or exceed the forces associated with plastic hinging of the beams adjacent to the connection.
- b. The connections shall demonstrate an interstory drift angle of at least 0.02 radians in cyclic tests.”

10.5.22 Changes to Section 11.4 - MOMENT CONNECTIONS

“Connections shall be designed for the applicable factored load combinations and their design strength shall meet the requirements in Section 7 and Section 11.2 of Part I.”

10.5.23 Changes to Section 12.4 - BRACES

“12. COMPOSITE SPECIAL CONCENTRICALLY BRACED FRAMES (C-SCBF)

12.4. Braces

Structural steel braces shall meet the requirements for SCBF in Part I Section 13. Composite braces shall meet the requirements for composite columns in Section 12.2.

13. COMPOSITE ORDINARY BRACED FRAMES (C-OBF)

13.1. Scope

This section is applicable to concentrically braced frame systems that consist of either composite or reinforced concrete columns, structural steel or composite beams, and structural steel or composite braces. C-OBF shall be designed assuming that under the Design Earthquake limited inelastic action will occur in the beams, columns, braces, and/or connections.”

10.5.24 Change title for Section 15.3 to “**15.3 Steel Coupling Beams.**”

10.5.25 Change title for Section 16.3 to “**16.3 Steel Coupling Beams.**”

10.5.26 Add new Section 15.4 as follows:

“15.4. Encased Composite Coupling Beams

Encased composite sections serving as Coupling Beams shall meet the requirements in Section 15.3 as modified in this Section:

15.4a. Coupling Beams shall have an embedment length into the reinforced concrete wall that is sufficient to develop the maximum possible combination of moment and shear capacities of the encased steel Coupling Beam.

15.4b. The nominal shear capacity of the encased steel Coupling Beam shall be used to meet the requirement in Section 15.3b.

15.4c. The stiffness of the encased steel Coupling Beams shall be used for calculating the shear wall and Coupling Beam design forces.”

10.5.27 Add new Section 16.4 as follows:

“16.4. Encased Composite Coupling Beams

Encased composite sections serving as Coupling Beams shall meet the requirements in Section 16.3, except the requirements in Part I Section 15.3 need not be met.

This page is intentionally left blank.

Chapter 11

MASONRY STRUCTURE DESIGN REQUIREMENTS

11.1 GENERAL

11.1.1 Scope. The design and construction of reinforced and plain masonry components and systems and the materials used therein shall comply with the requirements of this chapter. Masonry shall be designed in accordance with the requirements of ACI 530/ASCE 5/TMS 402. Masonry construction and materials shall be in accordance with the requirements of ACI 530.1/ASCE 6/TMS 602. Inspection and testing of masonry materials and construction shall be in accordance with the requirements of Chapter 2.

11.1.2 References. The following documents shall be used as specified in this chapter.

- ACI 530/ASCE 5/TMS 402 *Building Code Requirements for Masonry Structures* (ACI 530-02/ASCE 5-02/TMS 402-02), American Concrete Institute/American Society of Civil Engineers/The Masonry Society, 2002.
- ACI 530.1/ASCE 6/TMS 602 *Specification for Masonry Structures* (ACI 530.1-02/ASCE 6-02/TMS 602-02), American Concrete Institute/American Society of Civil Engineers/The Masonry Society, 2002.
- ACI 318 *Building Code Requirements for Structural Concrete*, American Concrete Institute, 2002, excluding Appendix A.

11.2 GENERAL DESIGN REQUIREMENTS

11.2.1 Classification of shear walls. Masonry walls, unless isolated from the lateral force resisting system, shall be considered shear walls and shall be classified in accordance with this section.

11.2.1.1 Ordinary plain (unreinforced) masonry shear walls. Ordinary plain (unreinforced) masonry shear walls shall satisfy the requirements of Section 1.13.2.2.1 of ACI 530/ASCE 5/TMS 402.

11.2.1.2 Detailed plain (unreinforced) masonry shear walls. Detailed plain (unreinforced) masonry shear walls shall satisfy the requirements of Section 1.13.2.2.2 of ACI 530/ASCE 5/TMS 402.

11.2.1.3 Ordinary reinforced masonry shear walls. Ordinary reinforced masonry shear walls shall satisfy the requirements of Section 1.13.2.2.3 of ACI 530/ASCE 5/TMS 402.

11.2.1.4 Intermediate reinforced masonry shear walls. Intermediate reinforced masonry shear walls shall satisfy the requirements of Section 1.13.2.2.4 of ACI 530/ASCE 5/TMS 402.

11.2.1.5 Special reinforced masonry shear walls. Special reinforced masonry shear walls shall satisfy the requirements of Section 1.13.2.2.5 of ACI 530/ASCE 5/TMS 402.

11.2.1.6 Shear keys. Add the following new Sec. 1.13.2.2.5 (d) to the Sec. 1.13.2.2.5 of ACI 530/ASCE 5/TMS 402. The surface of concrete upon which a special reinforced masonry shear wall is constructed shall have a minimum surface roughness of 1/8 in. (3 mm). Shear keys are required when the calculated tensile strain in vertical reinforcement from in-plane loads exceeds the yield strain under load combinations that include seismic forces based on an *R* factor equal to 1.5. Shear keys that satisfy the following requirements shall be placed at the interface between the wall and the foundation:

1. The width of the keys shall be at least equal to the width of the grout space,
2. The depth of the keys shall be at least 1.5 in. (38 mm),
3. The length of the key shall be at least 6 in. (152 mm),
4. The spacing between keys shall be at least equal to the length of the key,

5. The cumulative length of all keys at each end of the shear wall shall be at least 10 percent of the length of the shear wall (20 percent total),
6. At least 6 in. (150 mm) of a shear key shall be placed within 16 in. (406 mm) of each end of the wall, and
7. Each key and the grout space above each key in the first course of masonry shall be grouted solid.

11.2.2 Modifications to ACI 530/ASCE 5/TMS 402 and ACI 530.1/ASCE 6/TMS 602.

11.2.2.1 Additional definitions. Add the following definitions to Sec. 1.6 of ACI 530/ASCE 5/TMS 402:

“Actual dimension – The measured dimension of a designated item (e.g., a designated masonry unit or wall).

Cleanout – An opening to the bottom of a grout space of sufficient size and spacing to allow removal of debris.

Cover – Distance between surface of reinforcing bar and face of member.

Effective period – Fundamental period of the structure based on cracked stiffness.

Hollow masonry unit – A masonry unit whose net cross-sectional area in any plane parallel to the bearing surface is less than 75 percent of the gross cross-sectional area in the same plane.

Plastic hinge – The zone in a structural member in which the yield moment is anticipated to be exceeded under loading combinations that include earthquake. The zone in a masonry element in which earthquake energy is dissipated through the development of inelastic strains and curvatures.

Reinforced masonry – Masonry construction in which reinforcement acts in conjunction with the masonry to resist forces. Masonry in which the tensile resistance of masonry is neglected and the resistance of the reinforcing steel is considered in resisting applied loads.

Solid masonry unit – A masonry unit whose net cross-sectional area in any plane parallel to the bearing surface is 75 percent or more of the gross cross-sectional area in the same plane.

Special moment frame – A moment resisting frame of masonry beams and masonry columns within a plane with special reinforcement details and connections that provides resistance to lateral and gravity loads.

Specified – Required by construction documents.

Stirrup – Shear reinforcement in a beam or flexural member.”

11.2.2.2 Additional notation. Add the following notation to Sec. 1.5 of ACI 530/ASCE 5/TMS 402:

“ d_{bb} = diameter of the largest beam longitudinal reinforcing bar passing through, or anchored in, the special moment frame beam-*column* intersection.

d_{bp} = diameter of the largest *column* (pier) longitudinal reinforcing bar passing through, or anchored in, the special moment frame beam-*column* intersection.

h_x = height of structure above the base level to level x .

h_b = beam depth in the plane of the special moment frame.

h_c = cross-sectional dimension of grouted core of special moment frame member measured center to center of confining reinforcement.

L_c = length of coupling beam between coupled *shear walls*.

M_1, M_2 = nominal moment strength at the ends of the coupling beam.

V_g = unfactored shear force due to gravity loads.”

11.2.2.3. Delete Article 1.3 AE from ACI 530.1/ASCE 6/TMS 602.

11.2.2.4. Add the following exception after the second paragraph of Sec. 3.2.5.5 of ACI 530/ASCE 5/TMS 402.

“Exception: A nominal thickness of 4 in. (102 mm) shall be permitted where load-bearing reinforced hollow clay unit masonry walls satisfy all of the following conditions.

1. The maximum unsupported height-to-thickness or length-to-thickness ratios do not exceed 27,
2. The net area unit strength exceeds 8,000 psi (55 MPa),
3. Units are laid in running bond,
4. Bar sizes do not exceed No. 4 (13 mm),
5. There are no more than two bars or one splice in a cell, and
6. Joints are not raked.”

11.2.2.5. Add the following new Sec. 1.15.3 to ACI 530/ASCE 5/TMS 402:

“1.15.3 Separation joints. Where concrete abuts structural masonry and the joint between the materials is not designed as a separation joint, the concrete shall be roughened so that the average height of aggregate exposure is 1/8 in. (3 mm) and shall be bonded to the masonry in accordance with these requirements as if it were masonry. Vertical joints not intended to act as separation joints shall be crossed by horizontal reinforcement as required by Sec. 1.9.4.2.”

11.2.2.6. Add the following new Article 3.5 G to ACI 530.1/ASCE 6/TMS 602:

“3.5 G. Construction procedures or admixtures shall be used to facilitate placement and control shrinkage of grout.”

11.2.2.7. Replace Sec. 3.2.3.4(b) and 3.2.3.4(c) of ACI 530.1/ASCE 6/TMS 602 with the following:

“(b) A welded splice shall be capable of developing in tension 125 percent of the specified yield strength, f_y , of the bar. Welded splices shall only be permitted for ASTM A706 steel reinforcement. Welded splices shall not be permitted in plastic hinge zones of intermediate or special reinforced walls or special moment frames of masonry.

(c) Mechanical splices shall be classified as Type 1 or Type 2 according to Sec. 21.2.6.1 of ACI 318. Type 1 mechanical splices shall not be used within a plastic hinge zone or within a beam-column joint of intermediate or special reinforced masonry shear walls or special moment frames. Type 2 mechanical splices shall be permitted in any location within a member.”

11.2.2.8. Add the following new Sec. 3.2.3.4.1 and 3.2.3.4.2 to ACI 530/ASCE 5/TMS 402:

“3.2.3.4.1 Lap splices shall not be used in plastic hinge zones. The length of the plastic hinge zone shall be taken as at least 0.15 times the distance between the point of zero moment and the point of maximum moment.

3.2.3.4.2 Bars spliced by non-contact lap splices shall not be spaced transversely farther apart than the lesser of one-fifth the required length or 8 in. (203 mm).”

11.2.2.9. Add the following new Sec. 3.2.2(h) to ACI 530/ASCE 5/TMS 402:

“(h) For out-of-plane bending, the width of the equivalent stress block shall not be taken greater than 6 times the nominal thickness of the masonry wall or the spacing between reinforcement, whichever is less.”

11.2.2.10. Add the following new Sec. 3.2.7 to ACI 530/ASCE 5/TMS 402:

“3.2.7 Flanged shear walls

3.2.7.1 Effective width. Where wall intersections are constructed in accordance with Sec. 1.9.4, the effective flange width for design shall be determined in accordance with this section.

3.2.7.2 Compression. The width of flange considered effective in compression on each side of the web shall be taken equal to 6 times the thickness of the flange or the actual width of the flange on that side, whichever is less.

3.2.7.3 Tension. The width of flange considered effective in tension on each side of the web shall be taken equal to 3/4 of the wall height or the actual width of the flange on that side, whichever is less.”

11.2.2.11. Add the following new Sec. 3.2.4.2.6 to ACI 530/ASCE 5/TMS 402:

“3.2.4.2.6 Coupling beams. Structural members that provide coupling between shear walls shall be designed to reach their moment or shear nominal strength before either shear wall reaches its moment or shear nominal strength. Analysis of coupled shear walls shall comply with accepted principles of mechanics.

The design shear strength, ϕV_n , of the coupling beams shall satisfy the following criterion:

$$\phi V_n \geq \frac{1.25(M_1 + M_2)}{L_c} + 1.4V_g$$

where:

M_1 and M_2	=	nominal moment strength at the ends of the beam;
L_c	=	length of the beam between the shear walls; and
V_g	=	unfactored shear force due to gravity loads.

The calculation of the nominal flexural moment shall include the reinforcement in reinforced concrete roof and floor systems. The width of the reinforced concrete used for calculations of reinforcement shall be six times the floor or roof slab thickness.”

11.2.2.12. Add the following new Sec. 3.2.5 to ACI 530/ASCE 5/TMS 402:

“3.2.5 Deep flexural member detailing. Flexural members with overall-depth-to-clear-span ratio greater than 2/5 for continuous spans or 4/5 for simple spans shall be detailed in accordance with this section.

3.2.5.1. Minimum flexural tension reinforcement shall conform to Sec. 3.2.4.3.2.

3.2.5.2. Uniformly distributed horizontal and vertical reinforcement shall be provided throughout the length and depth of deep flexural members such that the reinforcement ratios in both directions are at least 0.001. Distributed flexural reinforcement is to be included in the determination of the actual reinforcement ratios.”

11.2.2.13. Add the following new Sec. 1.13.7.4 to ACI 530/ASCE 5/TMS 402:

“1.13.7.4 For structures in Seismic Design Category E or F, corrugated sheet metal anchors shall not be used.”

11.2.2.14. Revise Sec. 1.13.3.2 of ACI 530/ASCE 5/TMS 402/ to read as follows.

“ The calculated story drift of masonry structures due to the combination of design seismic forces and gravity loads shall not exceed the allowable story drift Δ_a for masonry walls shown in Table 4.5-1 of the 2003 *NEHRP Recommended Provisions*.

11.2.2.15. Add the following section to ACI 530/ASCE 5/TMS 402:

“1.13.4.3 Anchoring to masonry. Anchorage assemblies connecting masonry elements that are part of the seismic force resisting system to diaphragms and chords shall be designed so that the strength of the

anchor is governed by steel tensile or shear yielding. Alternatively, the anchorage assembly may be designed to be governed by masonry breakout or anchor pullout provided that the anchorage assembly is designed to resist not less than 2.5 times the factored forces transmitted by the assembly. “

11.2.2.16. Revise the following Sec. 3.1.4.4 of ACI 530/ASCE 5/TMS 402:

“**3.1.4.4 Anchor bolts** For cases where the nominal strength of an anchor bolt is controlled by masonry breakout or masonry pryout, ϕ shall be taken as 0.50. For cases where the nominal strength of an anchor bolt is controlled by anchor bolt steel, ϕ shall be taken as 0.90. For cases where the nominal strength of an anchor bolt is controlled by anchor pullout, ϕ shall be taken as 0.65.”

11.2.2.17. Revise the following Sec. 3.1.6.3 of ACI 530/ASCE 5/TMS 402:

“**3.1.6.3 Nominal shear strength of headed and bent-bar anchor bolts** — The nominal shear strength, B_{vn} , shall be computed by Eq. (3-8) (strength governed by masonry breakout) and Eq. (3-9) (strength governed by steel), and shall not exceed 2.0 times that computed by Eq. (3-4) (strength governed by masonry pryout). In computing the capacity, the smallest of the design strengths shall be used.”

11.2.2.18. Revise the following commentary to Sec. 3.1.6.3 of ACI 530/ASCE 5/TMS 402:

“**3.1.6.3 Nominal shear strength of headed and bent-bar anchor bolts** — The shear strength of a headed or bent-bar anchor bolt is governed by yield and fracture of the anchor steel, ~~or~~ by masonry shear breakout, or by masonry shear pryout. Steel strength is calculated conventionally using the effective tensile stress area (that is, threads are conservatively assumed to lie in the critical shear plane). Under static shear loading, bent-bar anchor bolts (J- or L-bolts) do not exhibit straightening and pullout. Under reversed cyclic shear however, available research^{3.1} suggests that straightening and pullout may occur.”

11.3 SPECIAL MOMENT FRAMES OF MASONRY

Special moment frames of masonry shall be designed and detailed in accordance with the requirements of Sec. 3.2 of ACI 530/ASCE 5/TMS 402 and this section.

Special moment frames shall be fully grouted and constructed using open-end hollow -unit concrete masonry or hollow-unit clay masonry.

Column nominal moment strength shall not be less than 1.6 times the column moment corresponding to the development of beam plastic hinges, except at the foundation level. The column axial load corresponding to the development of beam plastic hinges and including factored dead and live loads shall not exceed $0.15 A_n f'_m$. The plastic hinge zone shall be assumed equal to the depth of the member.

11.3.1 Calculation of required strength. The calculation of required strength of the members shall be in accordance with principles of engineering mechanics and shall consider the effects of the relative stiffness degradation of the beams and columns.

11.3.2 Flexural yielding. Flexural yielding shall be limited to the beams at the face of the columns and to the bottom of the columns at the base of the structure.

11.3.3 Materials. Neither Type N mortar nor masonry cement shall be used.

11.3.4 Reinforcement

11.3.4.1. The nominal moment strength at any section along a member shall not be less than 1/2 of the higher moment strength provided at the two ends of the member.

11.3.4.2. Lap splices are permitted only within the center half of the member length. Lap splices are not permitted in transverse reinforcement in beams, in plastic hinge zones in the column or in the beam-column joint.

11.3.4.3. Welded splices and mechanical connections may be used for splicing the reinforcement at any section, provided that not more than alternate longitudinal bars are spliced at a section and the distance between splices on alternate bars is at least 24 in. (610 mm) along the longitudinal axis and shall comply with the requirements of Section 11.3.7.4.

11.3.4.4. Reinforcement shall have a specified yield strength of 60,000 psi (414 MPa). The actual yield strength shall not exceed 1.3 times the specified yield strength.

11.3.5 Beams

11.3.5.1 Compression limit. The factored axial compression force on the beam shall not exceed 0.10 times the net cross-sectional area of the beam, A_n , times the specified compressive strength, f'_m .

11.3.5.2 Shear. The value of V_m shall be zero within any plastic hinge zone and in any columns subjected to net factored tension loads. The depth of the plastic hinge zone shall be assumed equal to the member depth..

11.3.5.3 Reinforcement ratio. The reinforcement ratio for beams that connect vertical elements of the seismic-force-resisting system shall not exceed the lesser of $0.15 \frac{f'_m}{f_y}$ or that determined in accordance with Sec. 3.2.3.5.1 of ACI 530/ASCE 5/TMS 402. All reinforcement in the beam and adjacent to the beam in a reinforced concrete roof or floor system shall be used to calculate the reinforcement ratio.

11.3.5.4 Proportions. The clear span for the beam shall not be less than 4 times its depth.

The nominal depth of the beam shall not be less than 4 units or 32 in. (813 mm), whichever is greater. The nominal depth to nominal width ratio shall not exceed 4.

Nominal width of the beams shall equal or exceed all of the following criteria:

1. 8 in. (203 mm),
2. width required by Sec. 3.2.4.2.5 of ACI 530/ASCE 5/TMS 402, and
3. 1/26 of the clear span between column faces.

11.3.5.5 Longitudinal reinforcement.

11.3.5.5.1. Longitudinal reinforcement shall not be spaced more than 8 in. (203 mm) on center.

11.3.5.5.2. Longitudinal reinforcement shall be uniformly distributed along the depth of the beam.

11.3.5.5.3. The minimum reinforcement ratio shall be $130/f_y$, where f_y is in psi (the metric equivalent is $0.90/f_y$, where f_y is in MPa).

11.3.5.5.4. At any section of a beam, each masonry unit through the beam depth shall contain longitudinal reinforcement.

11.3.5.6 Transverse reinforcement

11.3.5.6.1. Transverse reinforcement shall be one-piece and shall be hooked around top and bottom longitudinal bars and shall be terminated with a standard 180-degree hook.

11.3.5.6.2. Within an end region extending one beam depth from Special Moment Frame column faces and in any region at which beam plastic hinges may form during seismic or wind loading, the maximum spacing of transverse reinforcement shall not exceed one-fourth the nominal depth of the beam.

11.3.5.6.3. The maximum spacing of transverse reinforcement shall not exceed the lesser of 1/2 the nominal depth of the beam or the spacing required for shear strength.

11.3.5.6.4. The minimum transverse reinforcement ratio shall be 0.0015.

11.3.5.6.5. The first transverse bar shall not be more than 4 in. (102 mm) from the face of the column.

11.3.6 Columns

11.3.6.1 Compression limit. Factored axial compression force on the Special Moment Frame column corresponding to the development of beam plastic hinges shall not exceed 0.15 times the net cross-sectional area of the column, A_n , times the specified compressive strength. The compressive stress shall also be limited by the maximum reinforcement ratio.

11.3.6.2 Proportions. The nominal dimension of the column parallel to the plane of the Special Moment Frame shall not be less than two full units or 32 in. (810 mm), whichever is greater and shall not exceed 96 in.

The nominal dimension of the column perpendicular to the plane of the Special Moment Frame shall not be less than 8 in. (203 mm) or 1/14 of the clear height between beam faces, whichever is greater.

The clear-height-to-depth ratio of column members shall not exceed 5.

11.3.6.3 Longitudinal reinforcement

11.3.6.3.1. A minimum of 4 longitudinal bars shall be provided at all sections of every Special Moment Frame column member.

11.3.6.3.2. The flexural reinforcement shall be uniformly distributed across the member depth.

11.3.6.3.3. The nominal moment strength at any section along a member shall be not less than 1.6 times the cracking moment strength and the minimum reinforcement ratio shall be $130/f_y$, where f_y is in psi (the metric equivalent is $0.90/f_y$, where f_y is in MPa).

11.3.6.3.4. Vertical reinforcement in wall-frame columns shall be limited to a maximum reinforcement ratio equal to the lesser of $0.15 \frac{f'_m}{f_y}$ or that determined in accordance with Sec. 3.2.3.5 of Section 1.13.2.2.5 of ACI 530/ASCE 5/TMS 402. The minimum vertical reinforcement in wall-frame columns shall be 0.002 times the gross cross section.

11.3.6.4 Lateral reinforcement.

11.3.6.4.1. Transverse reinforcement shall be hooked around the extreme longitudinal bars and shall be terminated with a standard 180-degree hook.

11.3.6.4.2. The spacing of transverse reinforcement shall not exceed 1/4 the nominal dimension of the column parallel to the plane of the Special Moment Frame.

11.3.6.4.3. The minimum transverse reinforcement ratio shall be 0.0015.

11.3.6.4.4. Lateral reinforcement shall be provided to confine the grouted core when compressive strains caused by the factored axial and flexural loads at the design story drift, δ , exceed 0.0015. The unconfined portion of the cross section with a strain exceeding 0.0015 shall be neglected when computing the nominal strength of the section. The total cross sectional area of rectangular tie reinforcement for the confined core shall be not less than $0.9sh_c \frac{f'_m}{f_{yh}}$. Alternatively, equivalent

confinement which can develop an ultimate compressive strain of 0.006 may substituted for rectangular tie reinforcement.

11.3.7 Beam-column intersections

11.3.7.1 Proportions. Beam-column intersection dimensions in masonry special moment frames shall be proportioned such that the special moment frame column depth in the plane of the frame satisfies Eq. 11.3-1:

$$h_c > \frac{4800d_{bb}}{\sqrt{f'_g}} \quad (11.3-1)$$

where:

- h_p = column depth in the plane of the special moment frame, in.;
- d_{bb} = diameter of the largest beam longitudinal reinforcing bar passing through, or anchored in, the special moment frame beam-column intersection, in.; and
- f'_g = specified compressive strength of grout, psi (shall not exceed 5,000 psi (34.5MPa) for use in Eq. 11.3-1).

The metric equivalent of Eq. 11.3-1 is

$$h_c > \frac{400d_{bb}}{\sqrt{f'_g}}$$

where h_p and d_{bb} are in mm and f'_g is in MPa.

Beam depth in the plane of the frame shall satisfy Eq. 11.3-2:

$$h_b > \frac{1800d_{bp}}{\sqrt{f'_g}} \quad (11.3-2)$$

where:

- h_b = beam depth in the plane of the special moment frame, in.;
- d_{bp} = diameter of the largest column longitudinal reinforcing bar passing through, or anchored in, the special moment frame beam-column intersection, in.; and
- f'_g = specified compressive strength of grout, psi (shall not exceed 5,000 psi (34.5 MPa) for use in Eq. 11.3-2).

The metric equivalent of Eq. 11.3-2 is

$$h_b > \frac{150d_{bp}}{\sqrt{f'_g}}$$

where h_b and d_{bp} are in mm and f'_g is in MPa.

11.3.7.2 Shear strength. The design shear strength, NV_n , of the beams and columns shall not be less than the shear corresponding to the development of 1.4 times the nominal flexural strength of the member, except that the nominal shear strength need not exceed 2.5 times V_u . The nominal shear strength of beam-column intersections shall exceed the shear calculated assuming that the stress in all flexural tension reinforcement of the special moment frame beams at the column face is $1.4f_y$.

Vertical shear forces may be considered to be carried by a combination of masonry shear-resisting mechanisms and truss mechanisms involving intermediate column reinforcing bars.

The nominal horizontal shear stress at the beam-column intersection shall not exceed the lesser of 350 psi (2.5 MPa) or $7\sqrt{f'_m}$ (the metric equivalent is $0.58\sqrt{f'_m}$ MPa)

11.3.7.3 Horizontal reinforcement. Beam longitudinal reinforcement terminating in a special moment frame column shall be extended to the far face of the column and shall be anchored by a standard hook bent back into the special moment frame column.

Special horizontal shear reinforcement crossing a potential diagonal beam-column shear crack shall be provided such that:

$$A_s \geq \frac{0.5V_{jh}}{f_y} \quad (11.3-3)$$

where:

- A_s = cross-sectional area of reinforcement;
 V_{jh} = total horizontal joint shear; and
 f_y = specified yield strength of the reinforcement .

Special horizontal shear reinforcement shall be anchored by a standard hook around the extreme special moment frame column reinforcing bars.

11.4 GLASS-UNIT MASONRY AND MASONRY VENEER

11.4.1 Design lateral forces and displacements. Glass-unit masonry and masonry veneer shall be designed and detailed to satisfy the force and displacement requirements of Sec. 6.3.

11.4.2 Glass-unit masonry design.

11.4.2.1. The requirements of Chapter 7 of ACI 530/ASCE 5/TMS 402. shall apply to the design of glass unit masonry. The out-of-plane seismic strength shall be considered to be the same as the strength to resist wind pressure as specified in Sec. 7.3 of ACI 530/ASCE 5/TMS 402.

11.4.3 Masonry veneer design.

11.4.3.1. The requirements of Chapter 6 of ACI 530 shall apply to the design of masonry veneer.

11.4.3.2. For structures in Seismic Design Category E, corrugated sheet metal anchors shall not be used.

11.5 PRESTRESSED MASONRY

11.5.1. Prestressed masonry shall be designed in accordance with of ACI 530/ASCE 5/TMS 402 Chapter 4.

This page is intentionally left blank

Chapter 12

WOOD STRUCTURE DESIGN REQUIREMENTS

12.1 GENERAL

12.1.1 Scope. The design and construction of wood structures to resist seismic forces and the material used therein shall comply with the requirements of this chapter.

12.1.2 References. Documents containing requirements for the quality, testing, design, and construction of members and their fastenings in wood systems that resist seismic forces are listed in this section. The provisions of this chapter may add to, modify or exempt portions of the referenced documents.

12.1.2.1 Engineered wood construction

AF&PA/ASCE 16	<i>Standard for Load and Resistance Factor Design for Engineered Wood Construction</i> , American Forest & Paper Association/American Society of Civil Engineers, 1995, including supplements.
AF&PA SDPWS	ASD/LRFD Supplement, <i>Special Design Provisions for Wind and Seismic</i> , American Forest & Paper Association, 2001.
APA Y510T	<i>Plywood Design Specifications</i> , American Plywood Association, 1998.
APA N375B	<i>Design Capacities of APA Performance-Rated Structural-Use Panels</i> , American Plywood Association, 1995.
APA E315H	<i>Diaphragms</i> (APA Research Report 138), American Plywood Association, 1991.

12.1.2.2 Conventional light-frame construction

IRC	<i>International Residential Code</i> , International Code Council (ICC), 2003.
NF&PA T903	<i>Span Tables for Joists and Rafters</i> , National Forest and Paper Association, 1992.

12.1.2.3 Material standards

PS 20	<i>American Softwood Lumber Standard</i> , U.S. Department of Commerce, National Institute of Standards and Technology, 1999.
AITC A190.1	<i>American National Standard for Wood Products Structural Glued Laminated Timber</i> , American National Standards Institute/American Institute of Timber Construction, 1992.
ASTM A 653	<i>Specification for Steel Sheet, Zinc-Coated (Galvanized) or Zinc-Iron Alloy-Coated (Galvannealed) by the Hot-dip Process (A 653-97a)</i> , American Society for Testing and Materials, 1997.
ASTM A 792	<i>Specification for Steel Sheet, 55% Aluminum-Zinc Alloy-Coated by the Hot-dip Process (A 792-97a)</i> , American Society for Testing and Materials, 1997.
ASTM A 875	<i>Specification for Steel Sheet, Zinc-5% Aluminum Alloy-Coated by the Hot-dip Process (A 875-97a)</i> , American Society for Testing and Materials, 1997.

ASTM D 5055

Standard Specification for Establishing and Monitoring Structural Capacities of Prefabricated Wood I-Joists (D 5055-97^{e1}), American Society of Testing and Materials, 1997.

PS 1	<i>Construction and Industrial Plywood</i> , U.S. Department of Commerce, National Institute of Standards and Technology, 1995.
PS 2	<i>Performance Standard for Wood-Based Structural-Use Panels</i> , U.S. Department of Commerce, National Institute of Standards and Technology, 1992.
ANSI 05.1	<i>Wood Poles</i> , American National Standards Institute, 1992.
ANSI A208.1	<i>Wood Particleboard</i> , American National Standards Institute, 1992.
AWPA C1, 2, 3, 9, 28	<i>Preservative Treatment by Pressure Process</i> , American Wood Preservers Association, AWPA C1, C2, C3, and C28, 1991; C9, 1990.

12.1.3 Definitions

Bearing wall: See Sec. 4.1.3.

Blocked diaphragm: A diaphragm in which all sheathing edges not occurring on a framing member are supported on and fastened to blocking.

Boundary elements: See Sec. 2.1.3.

Braced wall line: A series of braced wall panels in a single story that satisfies the requirements of Sec. 12.4.1.

Braced wall panel: A section of wall braced in accordance with Sec. 12.4.1.

Cripple wall: A framed stud wall, less than 8 ft (2.4 m) tall, extending from the top of the foundation to the underside of the lowest floor framing. Cripple walls can occur in both engineered structures and conventional construction.

Diaphragm: See Sec. 4.1.3.

Drag strut: See Sec. 4.1.3.

Grade plane: See Sec. 6.1.3.

Light-framed shear wall: A wall constructed with wood or cold-formed steel studs and sheathed with material approved for shear resistance.

Light-framed wall: A wall with wood or steel studs.

Perforated shear wall: A wood structural panel sheathed wall with openings, but which has not been specifically designed and detailed for force transfer around wall openings.

Perforated shear wall segment: A section of shear wall with full height sheathing and which satisfies the aspect ratio limits of Sec.4.3.4.1 of the AF&PA SDPWS.

Seismic Design Category: See Sec. 1.1.4.

Seismic-force-resisting system: See Sec. 1.1.4.

Seismic Use Group: See Sec. 1.1.4.

Shear wall: See Sec. 4.1.3.

Story above grade: See Figure 12.4-1.

Structure: See Sec. 1.1.4.

Tie-down: A device used to resist uplift of the chords of shear walls. These devices are intended to resist load without significant slip between the device and the shear wall chord or be shown with cyclic testing to not reduce the wall capacity and ductility.

Wall: See Sec. 4.1.3.

Wood structural panel: A wood-based panel product that satisfies the requirements of PS 1 or PS 2 and is bonded with a waterproof adhesive. Included under this designation are plywood, oriented strand board, and composite panels.

12.1.4 Notation

A	Total area of openings in the perforated shear wall calculated such that opening height is assigned wall height, h , where structural sheathing is not present above or below openings and openings with height less than $h/3$ are assigned a height of $h/3$;
h	Height of the perforated shear wall.
L_{tot}	Total length of a perforated shear wall including the lengths of perforated shear wall segments and the lengths of segments containing openings;
r	Sheathing area ratio. Perforated shear walls shall have a minimum sheathing area ratio of 0.1.
V_{wall}	Nominal shear capacity of a perforated shear wall.
v_{wall}	Nominal unit shear capacity for wood structural panel from Table 4.3A.
ΣL_i	Sum of lengths of perforated shear wall segments.

12.2 DESIGN METHODS

Structures constructed in accordance with Sec. 12.5 are deemed to satisfy Sec. 1.5. Where a structure of otherwise conventional construction contains structural elements that do not comply with the requirements of Sec. 12.5, such elements shall be designed in accordance with Sec. 12.3 and 12.4.

12.2.1 Seismic Design Categories B, C, and D. Unless excepted by Sec. 1.1.2.1, structures assigned to Seismic Design Category B, C, or D shall satisfy the requirements for engineered wood construction in accordance with LRFD provisions of *AF&PA SDPWS* as modified by Sec. 12.2.3 or shall satisfy the requirements for conventional light-frame construction in accordance with Sec. 12.5.

12.2.2 Seismic Design Categories E and F. Unless excepted by Sec. 1.1.2.1, structures assigned to Seismic Design Category E or F shall satisfy the requirements for engineered wood construction in accordance with LRFD provisions of *AF&PA SDPWS* as modified by Sec. 12.2.4.

12.2.3 Modifications to AF&PA SDPWS for Seismic Design Categories B, C and D

12.2.3.1 Revise second sentence of Sec. 4.1.2 of *AF&PA SDPWS* as follows:

“Alternatively, shear capacity of diaphragms and shear walls shall be permitted to be calculated by principles of mechanics using values of fastener strength and sheathing shear capacity provided consideration is given to the combined fastener and sheathing performance under cyclic loading.”

12.2.3.2 Replace last paragraph of Sec. 4.2.2 of *AF&PA SDPWS* with the following:

“The mid-span deflection of a single span blocked wood structural panel diaphragm uniformly loaded and uniformly nailed throughout shall be calculated using a rational analysis accounting for bending deformation, panel shear deformation, non-linear slip in the sheathing to framing connections, and boundary member connections. Adjustments shall be made for other span, blocking, loading and nailing configurations.”

12.2.3.3 In Table 4.2.4 of *AF&PA SDPWS*, modify aspect ratio for “Double-layer diagonal lumber sheathing” from 4:1 to 3:1.

12.2.3.4 Add sentence to 4.2.7.1(1) of *AF&PA SDPWS* as follows:

“Sheathing shall be arranged so that the width shall not be less than 2 ft (0.6 m).”

12.2.3.5 Add Sec. 4.2.7.1(5) to AF&PA SDPWS as follows:

“4.2.7.1(5) It is advised that the edge distance be increased where possible to reduce the potential for splitting of the framing and nail pull through in the sheathing.”

12.2.3.6 Delete 4.2.7.4 and related design values from Tables 4.2C from AF&PA SDPWS.**12.2.3.7** Replace last paragraph of Sec. 4.3.2 of AF&PA SDPWS with the following:

“The deflection of a wood structural panel shear wall shall be calculated using a rational analysis accounting for bending deformation, panel shear deformation, non-linear slip in the sheathing to framing connections and boundary member connections.”

12.2.3.8 Replace first 3 paragraphs of Sec. 4.3.3.2 of AF&PA SDPWS (keep wind exception) with the following:

“The shear values for wood structural panel sheathing of different capacities applied to the same side of the wall are not cumulative except as allowed in Table 12.2-3a and 12.2-3b. The shear values for structural panel sheathing of the same capacity applied to both faces of the same wall are cumulative. Where the structural panel sheathing capacities are not equal, the allowable shear shall be either two times the smaller shear capacity or the capacity of the stronger side, whichever is greater. Shear capacities shall not be summed where dissimilar materials are applied to opposite faces or to the same wall line.”

12.2.3.9 Add paragraph to Sec. 4.3.3.4 of AF&PA SDPWS as follows:

“The nominal shear capacity of a perforated shear wall is permitted to be calculated in accordance with the following:

$$V_{wall} = \frac{r}{3-2r} L_{tot} v_{wall}$$

$$r = \frac{1}{1 + \frac{A}{h \sum L_i}}$$

where:

V_{wall} = nominal shear capacity of a perforated shear wall;

r = sheathing area ratio. Perforated shear walls shall have a minimum sheathing area ratio of 0.1;

L_{tot} = total length of a perforated shear wall including the lengths of perforated shear wall segments and the lengths of segments containing openings;

v_{wall} = nominal unit shear capacity for wood structural panel from Table 4.3A;

A = total area of openings in the perforated shear wall calculated such that opening height is assigned wall height, h , where structural sheathing is not present above or below openings and openings with height less than $h/3$ are assigned a height of $h/3$;

h = height of the perforated shear wall; and,

$\sum L_i$ = sum of lengths of perforated shear wall segments.”

12.2.3.10 Replace Sec. 4.3.5.2b of AF&PA SDPWS with the following:

“b. The nominal shear value for wood structural panels used in a perforated shear wall shall not exceed 980 lb/ft (14.5 kN/m).”

12.2.3.11 Replace paragraph 1 of 4.3.6.4b of AF&PA SDPWS with the following:

“b. Where net uplift is induced, tie-down devices shall be used. Nuts on tie-down bolts shall be tightened without crushing the wood prior to covering the framing. Tie-down devices shall be attached to the end posts with nails, screws, or other fasteners. All tie-down devices shall only be

used where the uplift resistance values are based on cyclic testing of wall assemblies and the test results indicate that the tie-down device does not reduce the stiffness, ductility, or capacity of the shear wall where compared to nailed-on devices. Nominal strength of the tie-down assemblies shall be equal to or greater than the forces resulting from the nominal strength of the wall. The stiffness of the tie-down assemblies shall be such as to prevent premature failure of the sheathing fasteners, and the effect of the tie-down displacement shall be included in drift calculations. End posts shall be selected such that failure across the net section of the post is not a limit state for the connection of the tie-down.”

12.2.3.12 Replace 4.3.6.4c of AF&PA SDPWS with the following:

“c. Shear wall bottom plate connections to floor framing or foundations shall have a nominal strength equal to or greater than the nominal strength of the shear wall.

Foundation anchor bolts shall have a plate washer under the nut. The minimum plate washer sizes shall be determined in accordance with the following (Table 12.2-1):

Table 12.2.1 Minimum Plate Washers for Foundation Anchor Bolts

Anchor bolt size	Plate washer size
1/2 and 5/8 in. (13 and 16 mm)	1/4 by 3 by 3 in. (6 by 75 by 75 mm)
3/4, 7/8, and 1 in. (19, 22, and 25 mm)	3/8 by 3 by 3 in. (10 by 75 by 75 mm)

The hole in a plate washer is permitted to be diagonally slotted with a width of up to 3/16 inches (5mm) larger than the bolt diameter and a slot length not to exceed 1.75 inches (44mm), if a standard cut washer is placed between the plate washer and the nut.

Foundation anchor bolts shall be placed a maximum of 2 in. (50 mm) from the sheathed side of walls sheathed on one face. Walls sheathed on both faces shall have the bolts staggered with each bolt a maximum of 2 in. (50 mm) from either side of the wall. Alternatively, for walls sheathed on both faces, the bolts shall be placed at the center of the foundation sill with the edge of the plate washer within 0.5 in. (13 mm) of each face of the wall. Where this alternative is used, the plate washer width shall be a minimum of 3 in. (75 mm) and the plate thickness shall be determined by analysis using the upward force on the plate equal to the tension capacity of the bolt.

Nuts on foundation anchor bolts shall be tightened without crushing the wood prior to covering the framing.”

12.2.3.13 Replace second sentence of 4.3.7.1a of AF&PA SDPWS as follows:

“Sheathing panels not less than 4ft x 8ft. Sheathing shall be arranged so that the width shall not be less than 2 ft (0.6 m).

Exception: For sheathing attached with the long direction of the panels perpendicular to the studs, a single sheathing panel with a minimum vertical dimension of 1 ft (0.3 m) and a minimum horizontal dimension of 4 ft (1.2 m) is permitted to be used if it is located at mid-height of the wall, and is fully blocked and fastened.”

12.2.3.14 Add Sec. 4.3.7.1f and 4.3.7.1g to AF&PA SDPWS as follows:

“f. It is advised that the edge distance be increased where possible to reduce the potential for splitting of the framing and nail pull through in the sheathing. Sheathing fasteners shall be driven flush with the surface of the sheathing.

g. Where wood structural panel sheathing is used as the exposed finish on the exterior of outside

walls, it shall have an exterior exposure durability classification. Where wood structural panel sheathing is used on the exterior of outside walls but not as the exposed finish, it shall be of a type manufactured with exterior glue. Where wood structural panel sheathing is used elsewhere, it shall be of a type manufactured with intermediate or exterior glue.”

12.2.3.15 Delete 4.3.7.2, 4.3.7.3, 4.3.7.4, 4.3.7.7 and 4.3.7.8 and related design values from Tables 4.3A, 4.3B, and 4.3C from AF&PA SDPWS.

12.2.3.16 Add Table 12.2-2a and 12.2-2b as addendum to Table 4.2A.

12.2.3.17 Add Table 12.2-3a and 12.2-3b as addendum to Table 4.3A.

12.2.4 Modifications to AF&PA SDPWS for Seismic Design Categories E and F

Structures assigned to Seismic Design Categories E and F shall conform to the requirements of Sec. 12.2.3 for Seismic Design Categories B, C and D, and the requirements of this section.

12.2.4.1 Add second sentence to Sec. 4.2.7.1 of AF&PA SDPWS as follows:

“Unblocked diaphragms sheathed with wood structural panels shall not be considered to be part of the seismic-force-resisting system for structures assigned to Seismic Design Category E or F.”

12.2.4.2 Add second sentence to Sec. 4.3.3.1 of AF&PA SDPWS as follows:

“For structures assigned to Seismic Design Category E or F, tabulated nominal unit shear capacities for wood structural panel sheathed shear walls used to resist seismic forces in structures with concrete or masonry walls shall be one-half the values set forth in Table 4.3A.”

12.2.4.3 Add second sentence to Sec. 4.3.7.1 of AF&PA SDPWS as follows:

“Wood structural panel sheathing used for shear walls that are part of the seismic-force-resisting system shall be applied directly to the framing members for structures assigned to Seismic Design Category E or F.”

Table 12.2-2a Nominal Unit Shear Values (lb/ft) for Seismic Forces on Horizontal Wood Diaphragms

Panel Grade	Fastener		Minimum nominal panel thickness (in.)	Minimum nominal width of framing (in.)	Lines of fasteners	Blocked Diaphragms ^{a,b}					
	Type	Minimum penetration in framing (in.)				Fastener spacing (in.) at diaphragm boundaries (all Cases), at continuous panel edges parallel to load (Cases 3 and 4) and at all panel edges (Cases 5 and 6) ^{c,d}					
						4		2-1/2		2	
					6	4	4	4	3	3	2
Structural I	10d ^e common	1-1/2	23/32	3	2	1310	1740	1880	2460	—	—
				4	2	1510	1950	2150	2820	—	—
				4	3	1880	2620	2750	3620	—	—
Sheathing, single floor and other grades covered in PS 1 and PS 2	14 ga staples	2	23/32	3	2	1200	1200	1680	1800	2080	2400
				4	3	1680	1800	2280	2710	2880	3600
				3	2	1290	1740	1880	2450	—	—
	10d ^e common	1-1/2	23/32	4	2	1510	1950	2150	2780	—	—
				4	3	1880	2620	2740	3020	—	—
				3	2	1200	1200	1650	1800	2050	2400
	14 ga staples	2	23/32	4	3	1650	1800	2250	2710	2800	3020

^a Nominal unit shear values shall be adjusted in accordance with AF&PA SDPWS Sec. 4.2.3 to determine LRFD factored unit resistance.

^b For framing grades other than Douglas-Fir Larch or Southern Pine, reduced nominal shear capacities shall be determined by multiplying the tabulated nominal unit shear capacity by the Specific Gravity Adjustment Factor = $[1 - (0.5 - G)]$, where G = Specific Gravity of the framing lumber from the NDS. The Specific Gravity Adjustment Factor shall not be greater than 1.^c Fasteners at intermediate framing members shall be spaced at 12 in. on center except that where spans are greater than 32 in. they shall be spaced at 6 in. on center.

^c Fasteners at intermediate framing members shall be spaced at 12 in. on center except that where spans are greater than 32 in. they shall be spaced at 6 in. on center.

^d Maximum nominal shear for Cases 3 through 6 is limited to 2310 lb/ft.

^e Where 10d nails are spaced at 3 in. or less on center and penetrate framing by more than 1-5/8 in., adjoining panel edges shall have 3 in. nominal width framing and panel edge nails shall be staggered.

Table 12.2-2b Nominal Unit Shear Values (kN/m) for Seismic Forces on Horizontal Wood Diaphragms

Panel Grade	Fastener		Minimum nominal panel thickness (mm)	Minimum nominal width of framing (mm)	Lines of fasteners	Blocked Diaphragms ^{a,b}					
	Type	Minimum penetration in framing (mm)				Fastener spacing (mm) at diaphragm boundaries (all Cases), at continuous panel edges parallel to load (Cases 3 and 4) and at all panel edges (Cases 5 and 6) ^{c,d}					
						100		65		50	
					Spacing per line at other panel edges (mm)						
					150	100	100	75	75	75	50
Structural I	10d ^e common	38	18	100	2	19.1	25.4	27.4	35.9	—	—
	14 ga staples	50	18	100	3	22.0	28.5	31.4	41.2	—	—
Sheathing, single floor and other grades covered in PS 1 and PS 2	10d ^e common	38	18	100	2	27.4	38.2	40.1	52.8	—	—
	14 ga staples	50	18	100	2	17.5	17.5	24.5	26.3	30.4	35.0
	14 ga staples	50	18	100	3	24.5	26.3	33.3	39.5	42.0	52.5
					2	18.8	25.4	27.4	35.8	—	—
					2	22.0	28.5	31.4	40.6	—	—
					3	27.4	38.2	40.0	44.1	—	—
					2	17.5	17.5	24.1	26.3	29.9	35.0
					3	24.1	26.3	32.8	39.5	40.9	44.1

^a Nominal unit shear values shall be adjusted in accordance with AF&PA SDPWS Sec. 4.2.3 to determine LRFD factored unit resistance.
^b For framing grades other than Douglas-Fir Larch or Southern Pine, reduced nominal shear capacities shall be determined by multiplying the tabulated nominal unit shear capacity by the Specific Gravity Adjustment Factor = $[1 - (0.5 - G)]$, where G = Specific Gravity of the framing lumber from the NDS. The Specific Gravity Adjustment Factor shall not be greater than 1.
^c Fasteners at intermediate framing members shall be spaced at 300 mm on center except that where spans are greater than 810 mm they shall be spaced at 150 mm on center.
^d Maximum nominal shear for Cases 3 through 6 is limited to 2310 lb/ft.
^e Where 10d nails are spaced at 75 mm or less on center and penetrate framing by more than 41 mm, adjoining panel edges shall have 75 mm nominal width framing and panel edge nails shall be staggered.

Table 12.2-3a Nominal Unit Shear Values (lb/ft) for Seismic Forces on Wood Structural Panel Shear Walls^{a,b,c}

Panel Grade	Panel Thickness (in.)	Minimum Penetration in Framing (in.)	Fastener Size	Fastener Spacing at Panel Edges (in.)		
				6	4	3
Panel Applied Over 1/2 in. or 5/8 in. Gypsum Sheathing (common or hot-dipped galvanized box nails)						
Structural I	3/8	1-1/4	8d	400	600	780
	3/8	1-3/8	10d ^e	460	720	920
	7/16	1-3/8	10d ^e	510	780	1020
	15/32	1-3/8	10d ^e	550	860	1110
	3/8	1-1/4	8d	400	600	780
Sheathing, Panel Siding, and Other Grades Covered in PS 1 and PS 2	3/8	1-3/8	10d ^e	450	650	820
	7/16	1-3/8	10d ^e	480	710	910
	15/32	1-3/8	10d ^e	520	750	980
Panel Applied Over 1/2 in. or 5/8 in. Gypsum Sheathing (hot-dipped galvanized casing nails)						
Panel Siding as Covered in PS 1	3/8	1-1/4	8d	280	420	550
	3/8	1-3/8	10d ^e	320	480	620
Panel Applied Directly to Framing						
Structural I	3/8	2	14 ga staple	290	450	600
	7/16	2	14 ga staple	420	620	820
Sheathing, Panel Siding, and Other Grades Covered in PS 1 and PS 2	3/8	2	14 ga staple	260	380	510
	7/16	2	14 ga staple	350	550	720
	15/32	2	14 ga staple	420	620	820

^a Nominal unit shear values shall be adjusted in accordance with AF&PA SDPWS Sec. 4.3.3 to determine LRFD factored unit resistance.

^b For framing grades other than Douglas-Fir Larch or Southern Pine, reduced nominal shear capacities shall be determined by multiplying the tabulated nominal unit shear capacity by the Specific Gravity Adjustment Factor = $[1 - (0.5 - G)]$, where G = Specific Gravity of the framing lumber from the NDS. The Specific Gravity Adjustment Factor shall not be greater than 1.

^c Where panels are applied on both faces of a wall and fastener spacing is less than 6 in. on center on either side, panel joints shall be offset to fall on different framing members or framing shall be 3 in. nominal or wider and fasteners on each side of joint shall be staggered.

^d Framing at adjoining panel edges shall be 3 in. nominal or wider and fasteners shall be staggered where nails are spaced 2 in. on center.

^e Where 10d nails are spaced at 3 in. or less on center and penetrate framing by more than 1-5/8 in., adjoining panel edges shall have 3 in. nominal width framing and panel edge nails shall be staggered.

Table 12.2-3b Nominal Unit Shear Values (kN/m) for Seismic Forces on Wood Structural Panel Shear Walls^{a,b,c}

Wood Structure Design Requirements

Panel Grade	Panel Thickness (mm)	Minimum Penetration in Framing (mm)	Fastener Size	Fastener Spacing at Panel Edges (mm)			
				150	100	75	50 ^d
Panel Applied Over 12.7 mm or 15.9 mm Gypsum Sheathing (common or hot-dipped galvanized box nails)							
Structural I	9.5	32	8d	5.8	8.8	11.4	14.9
	9.5	35	10d ^e	6.7	10.5	13.4	17.8
	11	35	10d ^e	7.4	11.4	14.9	19.6
	12	35	10d ^e	8	12.6	16.2	21.3
	9.5	32	8d	5.8	8.8	11.4	14.9
Sheathing, Panel Siding, and Other Grades Covered in PS 1 and PS 2	9.5	35	10d ^e	6.6	9.5	12.0	15.5
	11	35	10d ^e	7.0	10.4	13.3	17.1
	12	35	10d ^e	7.6	10.9	14.3	18.7
Panel Applied Over 12.7 mm or 15.9 mm Gypsum Sheathing (hot-dipped galvanized casing nails)							
Panel Siding as Covered in PS 1	9.5	32	8d	4.1	6.1	8.0	10.5
	9.5	35	10d ^e	4.7	7.0	9.0	12
Panel Applied Directly to Framing							
Structural I	9.5	2	14 ga staple	4.2	6.6	8.8	13.0
	11	2	14 ga staple	6.1	9.0	12.0	18.0
Sheathing, Panel Siding, and Other Grades Covered in PS 1 and PS 2	9.5	2	14 ga staple	3.8	5.5	7.4	11.2
	11	2	14 ga staple	5.1	8.0	10.5	15.8
	12	2	14 ga staple	6.1	9.0	12.0	18.0

^a Nominal unit shear values shall be adjusted in accordance with AF&PA SDPWS Sec. 4.3.3 to determine LRFD factored unit resistance.

^b For framing grades other than Douglas-Fir Larch or Southern Pine, reduced nominal shear capacities shall be determined by multiplying the tabulated nominal unit shear capacity by the Specific Gravity Adjustment Factor = $[1 - (0.5 - G)]$, where G = Specific Gravity of the framing lumber from the NDS. The Specific Gravity Adjustment Factor shall not be greater than 1.

^c Where panels are applied on both faces of a wall and fastener spacing is less than 150 mm on center on either side, panel joints shall be offset to fall on different framing members or framing shall be 75 mm nominal or wider and fasteners on each side of joint shall be staggered.

^d Framing at adjoining panel edges shall be 75 mm nominal or wider and fasteners shall be staggered where nails are spaced 50 mm on center.

^e Where 10d nails are spaced at 75 mm or less on center and penetrate framing by more than 41 mm, adjoining panel edges shall have 75 mm nominal width framing and panel edge nails shall be staggered.

12.3 GENERAL DESIGN REQUIREMENTS FOR ENGINEERED WOOD CONSTRUCTION

The proportioning, design, and detailing of engineered wood systems, members, and connections shall be in accordance with the reference documents, except as modified by Sec. 12.2.3 and 12.2.4.

12.3.1 Framing. All wood columns and posts shall be framed to provide full end bearing. Alternatively, column and post end connections shall be designed to resist the full compressive loads, neglecting all end bearing capacity. Continuity of wall top plates or provision for transfer of induced axial load forces is required. When offsets occur in the wall line, portions of the shear wall on each side of the offset shall be considered as separate shear walls unless provisions for force transfer around the offset are provided.

12.4 CONVENTIONAL LIGHT-FRAME CONSTRUCTION

Conventional light-frame construction is a system constructed entirely of repetitive horizontal and vertical wood light-framing members selected from tables in NF&PA T903 and complying with the framing and bracing requirements of the IRC except as modified by the provisions in this section.

The requirements of this section are based on platform construction. Other framing systems must have equivalent detailing to ensure force transfer, continuity, and compatible deformation.

Where a structure of otherwise conventional light-frame construction contains structural elements that do not comply with the requirements of this section, such elements shall satisfy the requirements for engineered wood construction as indicated in Sec. 12.2.

12.4.1 Limitations

12.4.1.1 General. Structures with concrete or masonry walls above the basement story shall not be considered to be conventional light-frame construction. Construction with concrete and masonry basement walls shall be in accordance with the IRC or equivalent.

Conventional light-frame construction is limited to structures with bearing wall heights not exceeding 10 ft (3 m) and the number of stories prescribed in Table 12.4-1. The gravity dead load of the construction is limited to 15 psf (0.7 kN/m²) for roofs and exterior walls and 10 psf (0.5 kN/m²) for floors and partitions and the gravity live load is limited to 40 psf (1.9 kN/m²). Figure 12.4-1 illustrates the definition of story above grade.

Exceptions: Masonry veneer is acceptable for:

1. The first story above grade, or the first two stories above grade where the lowest story has concrete or masonry walls, for structures assigned to Seismic Design Category B or C.
2. The first two stories above grade, or the first three stories above grade where the lowest story has concrete or masonry walls, for structures assigned to Seismic Design Category B, if wood structural panel wall bracing is used and the length of bracing provided is 1.5 times the length required by Table 12.4-2.

Table 12.4-1 Braced Walls for Conventional Light-Frame Construction

Seismic Design Category	Maximum Distance Between Braced Walls	Maximum Number of Stories Permitted Above Grade ^a
A ^b	35 ft (10.7 m)	3
B	35 ft (10.7 m)	3
C	25 ft (7.6 m)	2
D and	25 ft (7.6 m)	1 ^c

Table 12.4-1 Braced Walls for Conventional Light-Frame Construction

Seismic Design Category	Maximum Distance Between Braced Walls	Maximum Number of Stories Permitted Above Grade ^a
E (Seismic Use Group I)		
E (Seismic Use Group II) and F	Conventional construction is not permitted; design in accordance with Sec. 12.2 is required.	

^a A cripple stud wall is considered to be a story above grade. Maximum bearing wall height shall not exceed 10 ft (3 m).

^b See exceptions in Sec. 1.1.2.1.

^c Detached one- and two-family dwellings are permitted to be two stories above grade.

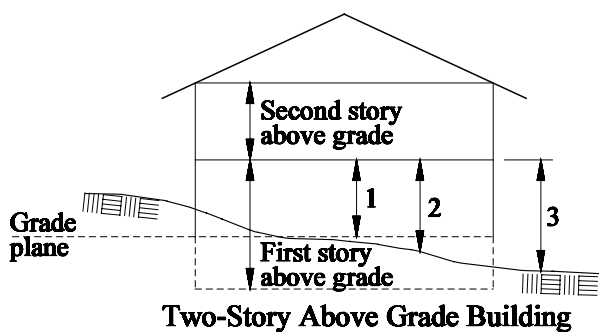

The lower floor level is classified as the first story if the finished floor surface of the floor level above is:

1. More than 6 ft (1.8 m) above the grade plane;
2. More than 6 ft (1.8 m) above grade for more than 50% of building perimeter; or
3. More than 12 ft (3.6 m) above grade at any point.

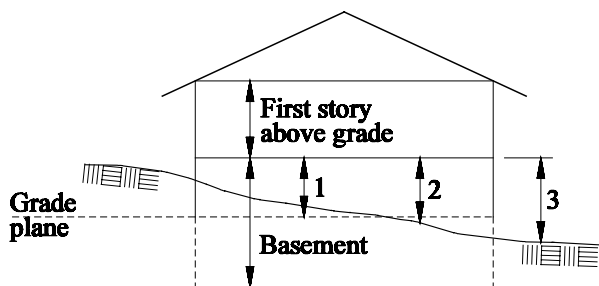

The upper floor level is classified as the first story if the finished floor surface of the floor level above is:

1. Not more than 6 ft (1.8 m) above the grade plane;
2. Not more than 6 ft (1.8 m) above grade for more than 50% of building perimeter; and
3. Not more than 12 ft (3.6 m) above grade at any point.

Figure 12.4-1 Definition of Story Above Grade.

12.4.1.2 Irregular structures. In Seismic Design Categories C, D, and E (Seismic Use Group I), irregular structures of conventional light-frame construction shall have a seismic-force-resisting system that is designed in accordance with Sec. 12.2 to resist the forces determined in accordance with Sec. 4.4. A structure shall be considered to have an irregularity where at least one of the conditions described in this section is present.

12.4.1.2.1 Out-of-plane offset. A structure shall be considered to have an irregularity where exterior braced wall panels are not in one plane vertically from the foundation to the uppermost story in which they are required. See Figure 12.4-2.

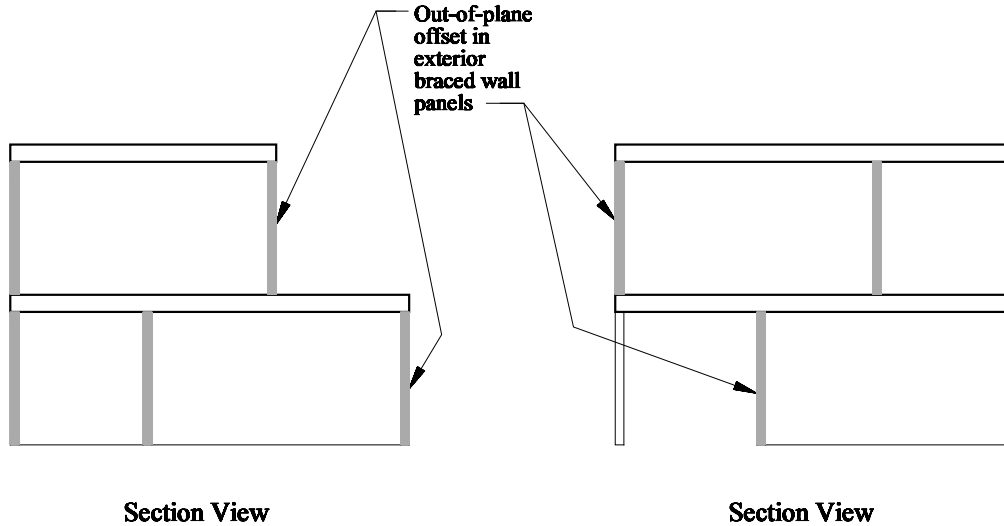

Figure 12.4-2 Out-of-Plane Offset Irregularity.

Exception: Floors with cantilevers or setbacks not exceeding four times the nominal depth of the floor joists (see Figure 12.4-3) are permitted to support braced wall panels provided that:

1. Floor joists are 2 by 10 in. nominal (actual: 1.5 by 9.25 in.; 38 by 235 mm) or larger and spaced not more than 16 in. (405 mm) on center.
2. The ratio of the back span to the cantilever is at least 2 to 1.
3. Floor joists at ends of braced wall panels are doubled.
4. A continuous rim joist is connected to the ends of all cantilevered joists. The rim joist shall be permitted to be spliced using a metal tie not less than 0.058 in. (16 gauge; 2 mm) thick and 1½ in. (38 mm) wide fastened with six 16d (0.162 by 3½ in.; 4 by 89 mm) common nails on each side. Steel used shall have a minimum yield of 33,000 psi (228 MPa), such as ASTM A 653 SS, Grade 33, ASTM A 792 SS, Grade 33, or ASTM A 875 SS, Grade 33.
5. Gravity loads carried by joists at setbacks or by the end of cantilevered joists are limited to single story uniform wall and roof loads and the reactions from headers having a span of 8 ft (2440 mm) or less.

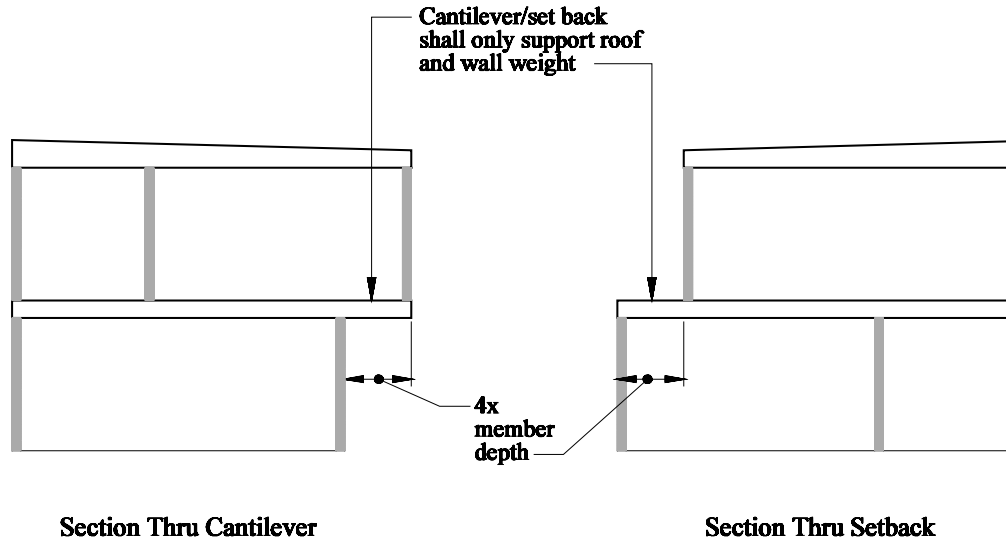

Figure 12.4-3 Permitted Cantilevers and Setbacks.

12.4.1.2.2 Unsupported diaphragm. A structure shall be considered to have an irregularity where a section of floor or roof is not laterally supported by braced wall lines on all edges. See Figure 12.4-4.

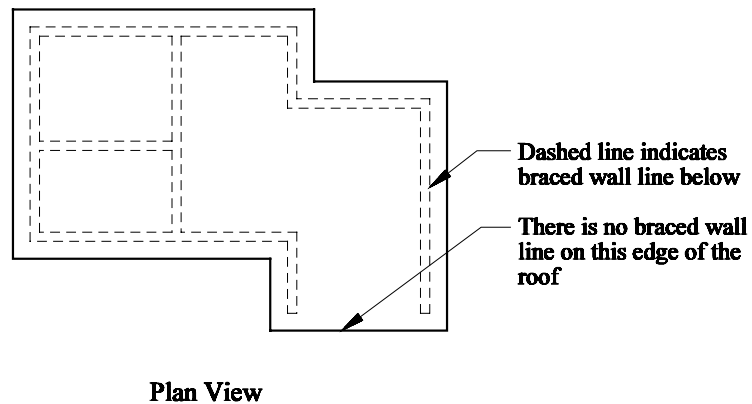
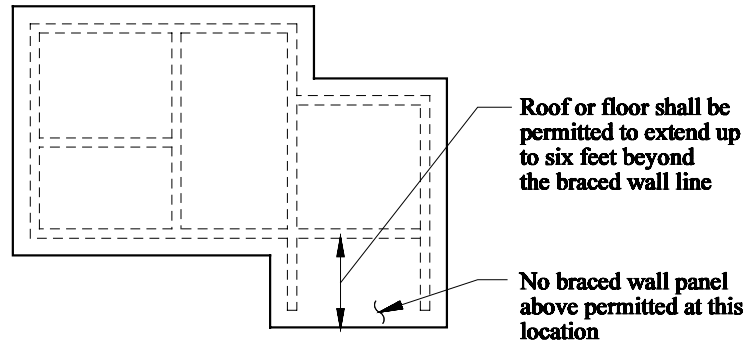

Figure 12.4-4 Unsupported Diaphragm Irregularity.

Exception: Portions of roofs or floors that support braced wall panels above shall be permitted to extend up to 6 ft (1.8 m) beyond a braced wall line. See Figure 12.4-5.



Plan View

Figure 12.4-5 Permitted Diaphragm Extension.

12.4.1.2.3 Opening in wall below. A structure shall be considered to have an irregularity where the end of a required braced wall panel extends more than 1 ft (0.3 m) over an opening in the wall below. This requirement is applicable to braced wall panels offset in plane and to braced wall panels offset out of plane as permitted by the exception to Sec. 12.4.1.2.1. See Figure 12.4-6.

Exception: Braced wall panels shall be permitted to extend over an opening not more than 8 ft (2.4 m) in width where the header is a 4 by 12 in. nominal (actual: 3.5 by 11.25 in.; 89 by 286 mm) or larger member.

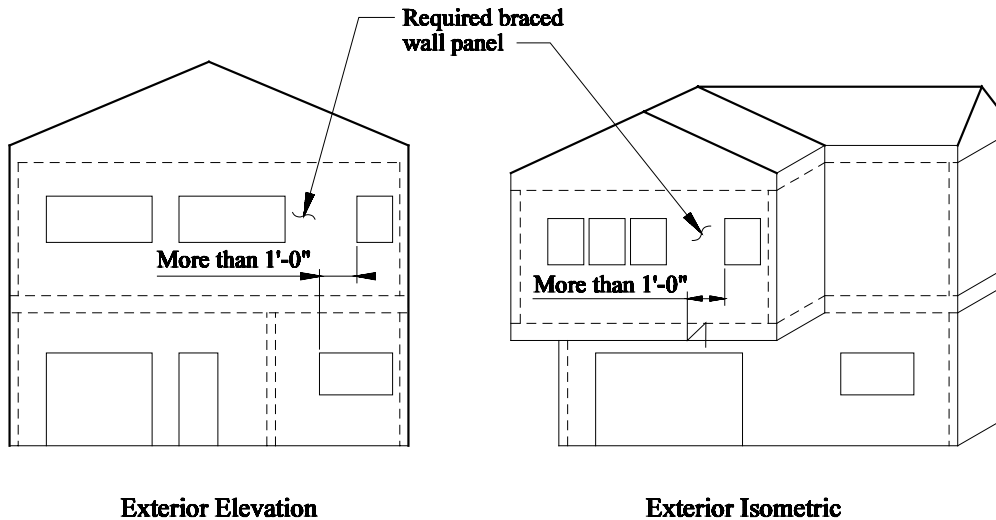

Figure 12.4-6 Opening in Wall Below Irregularity.

12.4.1.2.4 Vertical offset in diaphragm. A structure shall be considered to have an irregularity where portions of a floor level are vertically offset such that the framing members on either side of the offset cannot be lapped or tied together in an approved manner. See Figure 12.4-7.

Exception: This condition need not be considered for framing supported directly by foundations.

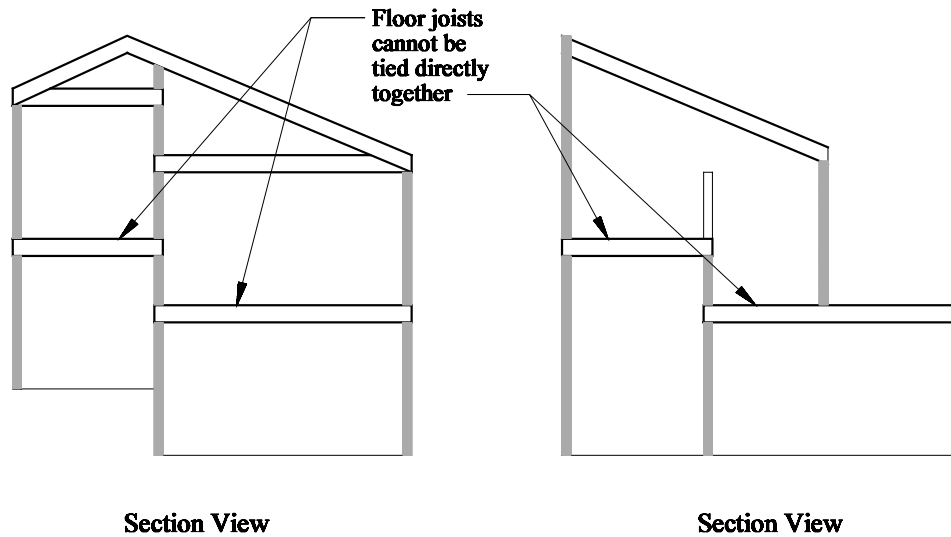

Figure 12.4-7 Vertical Offset Irregularity.

12.4.1.2.5 Non perpendicular walls. A structure shall be considered to have an irregularity where braced wall lines are not perpendicular to each other. See Figure 12.4-8.

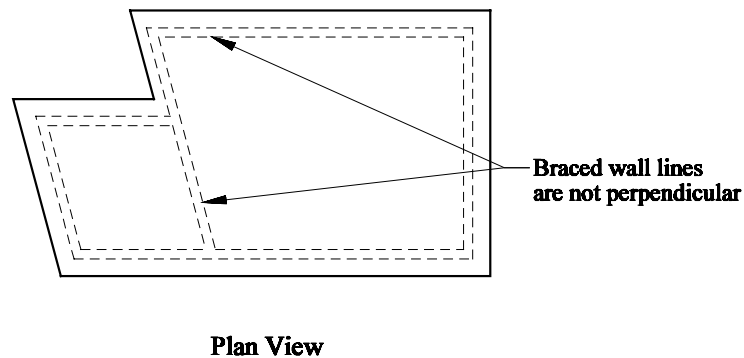

Figure 12.4-8 Non perpendicular Walls Irregularity.

12.4.1.2.6 Large diaphragm opening. A structure shall be considered to have an irregularity where floor or roof diaphragms have openings with a maximum dimension greater than 50 percent of the distance between lines of bracing or with an area greater than 25 percent of the area between orthogonal pairs of braced wall lines. See Figure 12.4-9.

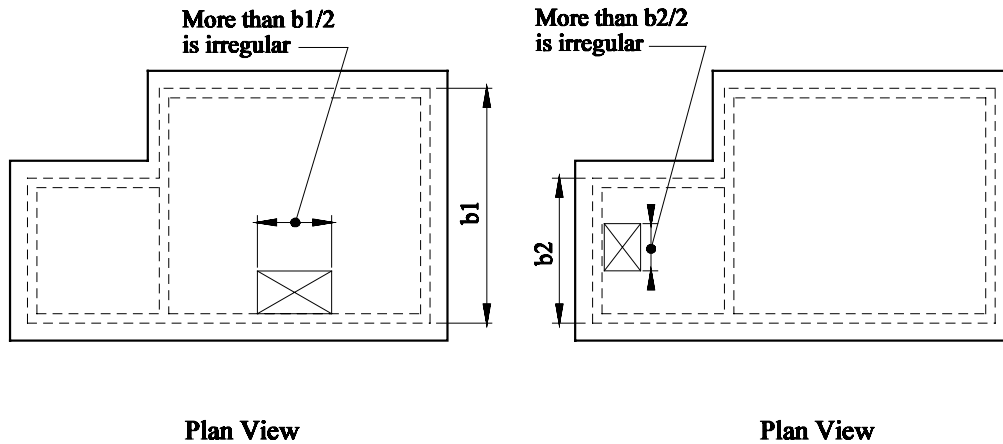

Figure 12.4-9 Diaphragm Opening Irregularity.

12.4.1.2.7 Stepped foundation. A structure shall be considered to have an irregularity where the shear walls from the foundation to the floor above vary in height by more than 6 ft (1.8 m).

12.4.2 Braced walls. The following are the minimum braced wall requirements.

12.4.2.1 Spacing between braced wall lines. Interior and exterior braced wall lines shall be located at the spacing indicated in Table 12.4-1.

12.4.2.2 Braced wall line sheathing. All braced wall lines shall be braced by one of the types of sheathing prescribed in Table 12.4-2. The required sum of lengths of braced wall panels at each braced wall line is prescribed in Table 12.4-2. Braced wall panels shall be distributed along the length of the braced wall line with sheathing placed at each end of the wall or partition or as near thereto as possible. All panel sheathing joints shall occur over studs or blocking. Sheathing shall be fastened to all studs and top and bottom plates and at panel edges occurring over blocking. All wall framing to which sheathing used for bracing is applied shall be 2 in. nominal (actual: 1.5 in.; 38 mm) or thicker members.

Cripple walls shall be braced as required for braced wall lines and shall be considered an additional story. Where interior post-and-girder framing is used, the capacity of the braced wall panels at exterior cripple walls shall be increased to compensate for the length of interior braced wall eliminated by increasing the length of the sheathing or by increasing the number of fasteners.

Table 12.4-2 Minimum Length of Wall Bracing for each 25 ft (7.6 m) of Braced Wall Line^a

Story Location	Sheathing Type ^b	$S_{DS} < 0.25$	$0.25 \leq S_{DS} < 0.375$	$0.375 \leq S_{DS} < 0.50$	$0.50 \leq S_{DS} < 0.75$	$0.75 \leq S_{DS} \leq 1.0^c$
Top or only story above grade	G-P ^d	8'-0" (2440 mm)	8'-0" (2440 mm)	10'-8" (3250 mm)	14'-8" (4470 mm)	18'-8" ^e (5690 mm)
	S-W ^f	4'-0" (1220 mm)	4'-0" (1220 mm)	5'-4" (1625 mm)	8'-0" (2440 mm)	9'-4" ^e (2845 mm)
Story below top story above grade	G-P ^d	10'-8" (3250 mm)	14'-8" (4470 mm)	18'-8" ^e (6590 mm)	NP	NP
	S-W ^f	5'-4" (1625 mm)	6'-8" (2030 mm)	10'-8" ^e (3250 mm)	13'-4" ^e (4065 mm)	17'-4" ^e (5280 mm)
Bottom story of 3 stories above grade	G-P ^d	14'-8" (4470 mm)	Conventional construction is not permitted; design in accordance with Sec. 12.2 is required.			
	S-W ^f	8'-0" (2440 mm)				

^a Minimum length of panel bracing on one face of wall for S-W sheathing or both faces of wall for G-P sheathing; h/b ratio shall not exceed 2/1, except that structures in Seismic Design Category B need only meet the requirements of Sec. R602.10.3 of the IRC. For S-W panel bracing of the same material on two faces of the wall, the minimum length is permitted to be one half the tabulated value but the h/b ratio shall not exceed 2/1 and design for uplift is required.

^b G-P = gypsumboard, fiberboard, particleboard, lath and plaster, or gypsum sheathing boards; S-W = wood structural panels and diagonal wood sheathing. NP = not permitted.

^c Where S_{DS} is greater than 1.0, conventional construction is not permitted.

^d Nailing of G-P sheathing shall be provided as follows at all panel edges at studs, at top and bottom plates, and at blocking, where it occurs:

For 1/2 in. (13 mm) gypsum board, 5d (0.086 in.; 2.2 mm) coolers at 7 in. (178 mm) on center;

For 5/8 in. (16mm) gypsum board, 6d (0.092 in.; 2.3 mm) at 7 in. (178 mm) on center;

For gypsum sheathing board, 1-3/4 in. (44 mm) long by 7/16 in. (11 mm) head, diamond point galvanized at 4 in. (100 mm) on center;

For gypsum lath, No. 13 gauge (0.092 in.; 2.3 mm) by 1-1/8 in. (29 mm) long, 19/64 in. (7.5 mm) head, plasterboard at 5 in. (125 mm) on center;

For Portland cement plaster, No. 11 gauge (0.120 in.; 3 mm) by 1-1/2 in. (89 mm) long, 7/16 in. (11 mm) head at 6 in. (150 mm) on center;

For fiberboard and particleboard, No. 11 gauge (0.120 in.; 3 mm) by 1-1/2 in. (38 mm) long, 7/16 in. (11 mm) head, galvanized at 3 in. (76 mm) on center.

^e Applies to one- and two-family detached dwellings only.

^f Nailing of S-W sheathing at a maximum of 6 inch spacing shall be provided at all panel edges to studs, to top and bottom plates, and blocking, where it occurs. At intermediate supports space nails at 6 inch spacing where 3/8 inch and 7/16 inch thick panels are installed on studs spaced 24 inches on center with the strong axis parallel to studs, and at a maximum 12 inch spacing for all other conditions. Minimum nail sizes are 6d common for 3/8" thick sheathing, and 8d common for 7/16 inch and 15/32 inch thick sheathing.

12.4.2.3 Attachment

12.4.2.3.1 Fastening of wall panel sheathing. Fastening of braced wall panel sheathing shall not be less than the minimum indicated by footnotes d and f of Table 12.4-2.

12.4.2.3.2 Nailing of diagonal boards. Diagonal boards of 1 inch nominal thickness and 6 inch nominal width shall be nailed to top and bottom plates and to studs located at braced wall ends with not less than three 8d common nails, and at intermediate supports with not less than two 8d common nails. Diagonal boards of 1 inch nominal thickness and 8 inch or greater nominal width shall be nailed to top and bottom plates and to studs located at braced wall ends with not less than four 8d common nails, and at intermediate supports with not less than three 8d common nails.

12.4.2.3.3 Adhesives. Adhesive attachment of wall sheathing is not permitted.

12.4.3 Detailing requirements. The following requirements for framing and connection details shall apply as a minimum.

12.4.3.1 Wall anchorage. Anchorage of braced wall line sills to concrete or masonry foundations shall be provided. Anchors shall be spaced at not more than 4 ft (1.2 m) on center for structures over two stories in height. For Seismic Design Categories C, D, and E, plate washers not smaller than ¼ by 3 by 3 in. in size shall be provided between the foundation sill plate and the nut. Other anchorage devices having equivalent capacity shall be permitted.

12.4.3.2 Top plates. Stud walls shall be capped with double top plates installed to provide overlapping at corners and intersections. End joints in double top plates shall be offset at least 4 ft (1220 mm). Single top plates shall be permitted to be used where they are spliced by framing devices providing capacity equivalent to the lapped splice prescribed for double top plates (Sec.12.4.3.4).

12.4.3.3 Bottom plates. Stud walls shall have full bearing on a 2 in. nominal (actual: 1.5 in.; 38 mm) or thicker plate or sill having a width at least equal to the width of the studs.

12.4.3.4 Braced wall panel connections. Provision shall be made to transfer forces from roofs and floors to braced wall panels and from the braced wall panels in upper stories to the braced wall panels in the story below. Where platform framing is used, such transfer at braced wall panels shall be accomplished in accordance with the following:

1. All braced wall panel top and bottom plates shall be fastened to joists, rafters, or full depth blocking. Braced wall panels shall be extended and fastened to roof framing at intervals not to exceed 50 ft (15 m).

Exception: Where roof trusses are used, provision shall be made to transfer lateral forces from the roof diaphragm to the braced wall.

2. Bottom plate fastening to joists or blocking below shall be with not fewer than three 16d (0.162 by 3½ in.; 4 by 89 mm) nails at 16 in. (400 mm) on center.
3. Blocking shall be nailed to the top plate below with not fewer than three 8d (0.131 by 2½ in.; 3 by 64 mm) toenails per block.
4. Joists parallel to the top plates shall be nailed to the top plate with not fewer than 8d (0.131 by 2½ in.; 3 by 64 mm) toenails at 6 in. (150 mm) on center.

In addition, top plate laps shall be nailed with not fewer than eight 16d (0.162 by 3½ in.; 4 by 89 mm) face nails on each side.

12.4.3.5 Foundations supporting braced wall panels. For structures with maximum plan dimensions not over 50 ft (15 m), foundations supporting braced wall panels are required at exterior walls only. Structures with plan dimensions greater than 50 ft (15 m) shall, in addition, have foundations supporting all required interior braced wall panels. Foundation-to-braced-wall connections shall be made at every foundation supporting a braced wall panel. The connections shall be distributed along the length of the braced wall line. Where all-wood foundations are used, the force transfer shall be determined based on calculation and shall have capacity greater than or equal to that for the connections required by Sec. 12.4.3.1.

12.4.3.6 Stepped foundations. Where the height of a required braced wall panel extending from foundation to floor above varies more than 4 ft (1.2 m) (see Figure 12.4-10), the following construction shall be used:

1. Where only the bottom of the footing is stepped and the lowest floor framing rests directly on a sill bolted to the footings, the requirements of Sec. 12.4.3.1 shall apply.
2. Where the lowest floor framing rests directly on a sill bolted to a footing not less than 8 ft (2.4 m) in length along a line of bracing, the line shall be considered to be braced. The double plate of the cripple stud wall beyond the segment of footing extending to the lowest framed floor shall be spliced to the sill plate with metal ties, one on each side of the sill and plate, not less than 0.058 in. (16 gauge; 2 mm) thick by 1.5 in. (38 mm) wide by 48 in. (1220 mm) long with eight 16d (0.162 by 3.5 in.; 4 by 89 mm) common nails on each side of the splice location. Steel used shall have a minimum yield of 33,000 psi (228 MPa), such as ASTM A 653 SS, Grade 33, ASTM A 792 SS, Grade 33, or ASTM A 875 SS, Grade 33.
3. Where cripple walls occur between the top of the footing and the lowest floor framing, the bracing requirements for a story shall apply.

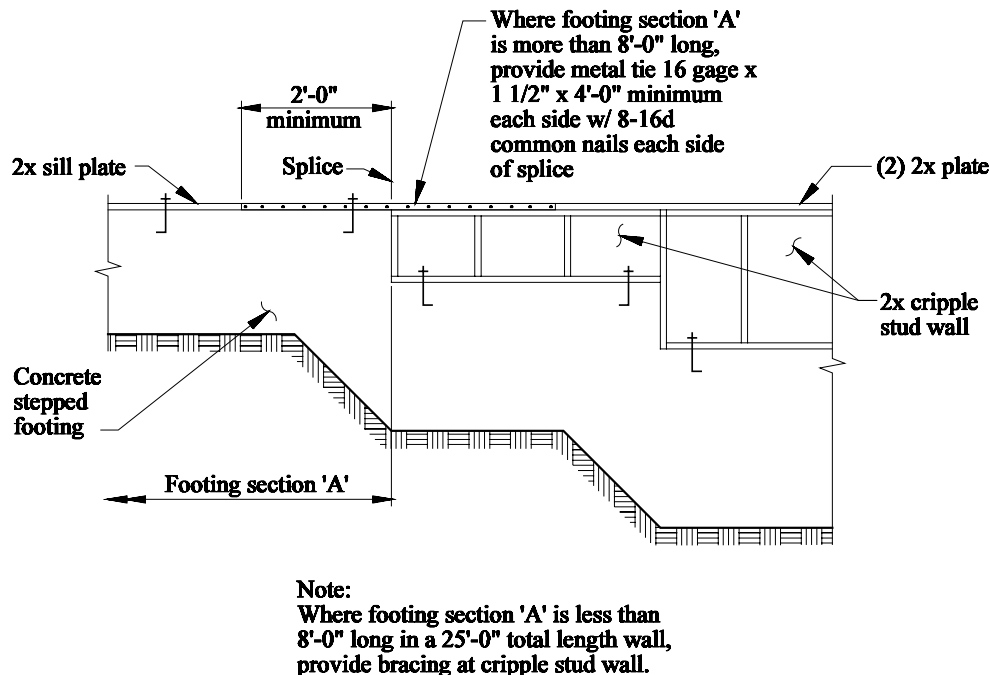

Figure 12.4-10 Detail for Stepped Foundation.

12.4.3.7 Detailing for openings in diaphragms. For openings with a dimension greater than 4 ft (1.2 m), or openings in structures assigned to Seismic Design Category D or E, the following minimum detail shall be provided. Blocking beyond headers and metal ties not less than 0.058 in. (16 gauge; 2 mm) thick by 1.5 in. (38 mm) wide by 48 in. (1220 mm) long with eight 16d (0.162 by 3.5 in.; 4 by 89 mm) common nails on each side of the header-joint intersection shall be provided (see Figure 12.4-11). Steel used shall have a minimum yield of 33,000 psi (228 MPa), such as ASTM A 653 SS, Grade 33, ASTM A 792 SS, Grade 33, or ASTM A 875 SS, Grade 33.

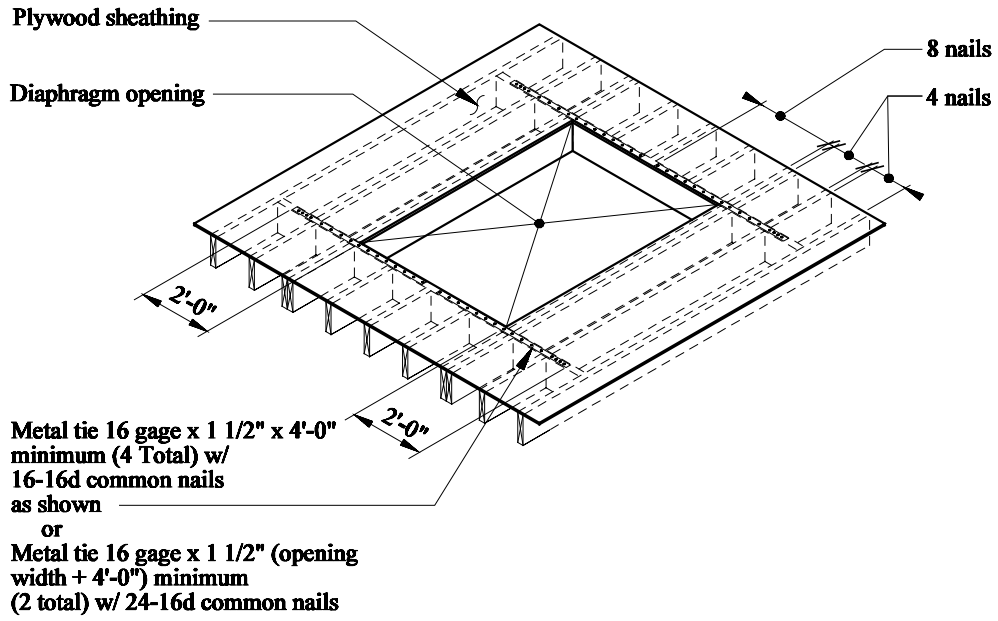

Figure 12.4 -11 Detail for Diaphragm Opening.

Chapter 13

SEISMICALLY ISOLATED STRUCTURE DESIGN REQUIREMENTS

13.1 GENERAL

13.1.1 Scope.

Every seismically isolated structure and every portion thereof shall be designed and constructed in accordance with the requirements of these *Provisions* as modified by this chapter.

13.1.2 Definitions.

Component: See Sec. 1.1.4.

Dead load: See Sec. 4.1.3.

Design displacement: The design earthquake lateral displacement, excluding additional displacement due to actual and accidental torsion, required for design of the isolation system.

Displacement restraint system: A collection of structural elements that limits lateral displacement of seismically isolated structures due to maximum considered earthquake ground shaking.

Effective damping: The value of equivalent viscous damping consistent with the energy dissipated during cyclic response of the isolation system.

Effective stiffness: The value of lateral force in the isolation system, or an element thereof, divided by the corresponding lateral displacement.

Isolation interface: The boundary between the upper portion of the structure, which is isolated, and the lower portion of the structure, which is assumed to move rigidly with the ground.

Isolation system: The collection of structural elements that includes all individual isolator units, all structural elements that transfer force between elements of the isolation system, and all connections to other structural elements. The isolation system also includes the wind-restraint system, energy-dissipation devices, and/or the displacement restraint system where such systems or devices are used to satisfy the design requirements of Chapter 13.

Isolator unit: A horizontally flexible and vertically stiff structural element of the isolation system that permits large lateral deformations under design seismic load. An isolator unit is permitted to be used either as part of or in addition to the weight-supporting system of the structure.

Live load: See Sec. 4.1.3.

Maximum considered earthquake ground motion: See Sec. 3.1.3.

Maximum displacement: The maximum considered earthquake lateral displacement, excluding additional displacement due to actual and accidental torsion.

Occupancy importance factor: See Sec. 1.1.4.

Registered design professional: See Sec. 2.1.3.

Seismic-force-resisting system: See Sec. 1.1.4.

Seismic Use Group: See Sec. 1.1.4.

Story: See Sec. 4.1.3.

Structure: See Sec. 1.1.4.

Total design displacement: The design earthquake lateral displacement, including additional displacement due to actual and accidental torsion, required for design of the isolation system or an element thereof.

Total maximum displacement: The maximum considered earthquake lateral displacement, including additional displacement due to actual and accidental torsion, required for verification of the stability of the isolation system or elements thereof, design of structure separations, and vertical load testing of isolator unit prototypes.

Wind-restraint system: The collection of structural elements that provides restraint of the seismically isolated structure for wind loads. The wind-restraint system may be either an integral part of isolator units or a separate device.

13.1.3 Notation

B_D	Numerical coefficient as set forth in Table 13.3-1 for effective damping equal to β_D .
B_M	Numerical coefficient as set forth in Table 13.3-1 for effective damping equal β_M
b	The shortest plan dimension of the structure measured perpendicular to d .
C_d	See Sec. 4.1.4.
D	See Sec. 4.1.4.
D_D	Design displacement at the center of rigidity of the isolation system in the direction under consideration as prescribed by Eq. 13.3-1.
D'_D	Design displacement at the center of rigidity of the isolation system in the direction under consideration applicable to dynamic procedures, as prescribed by Eq. 13.4-1.
D_M	Maximum displacement at the center of rigidity of the isolation system in the direction under consideration, as prescribed by Eq. 13.3-3.
D'_M	Maximum displacement at the center of rigidity of the isolation system in the direction under consideration applicable to dynamic procedures, as prescribed by Eq. 13.4-2.
D_{TD}	Total design displacement of an element of the isolation system including both translational displacement at the center of rigidity and the component of torsional displacement in the direction under consideration as prescribed by Eq. 13.3-5.
D_{TM}	Total maximum displacement of an element of the isolation system including both translational displacement at the center of rigidity and the component of torsional displacement in the direction under consideration as prescribed by Eq. 13.3-6.
d	The longest plan dimension of the structure.
E	See Sec. 4.1.4.
E_{loop}	Energy dissipated in an isolator unit or damping device during a full cycle of reversible load over a test displacement range from Δ^+ to Δ^- as measured by the area enclosed by the loop of the force-deflection curve.
e	The actual eccentricity measured in plan between the center of mass of the structure above the isolation interface and the center of rigidity of the isolation system, plus accidental eccentricity taken as 5 percent the maximum building dimension perpendicular to the direction of the force under consideration.
F^+	Positive force in an isolator unit during a single cycle of prototype testing at a displacement amplitude of Δ^+ .

F	Maximum negative force in an isolator unit during a single cycle of prototype testing a displacement amplitude of Δ .
g	Acceleration due to gravity.
h_i	See Sec. 5.1.3
h_{sx}	See Sec. 4.1.4.
h_x	See Sec. 5.1.3.
Level i	See Sec. 4.1.4.
K_{Dmax}	Maximum effective stiffness of the isolation system at the design displacement in the horizontal direction under consideration as prescribed by Eq. 13.6-3.
K_{Dmin}	Minimum effective stiffness of the isolation system at the design displacement in the horizontal direction under consideration as prescribed by Eq. 13.6-4.
K_{Mmax}	Maximum effective stiffness of the isolation system at the maximum displacement in the horizontal direction under consideration as prescribed by Eq. 13.6-5.
K_{Mmin}	Minimum effective stiffness of the isolation system at the maximum displacement in the horizontal direction under consideration, as prescribed by Eq. 13.6-6.
k_{eff}	Effective stiffness of an isolator unit, as prescribed by Eq. 13.6-1.
L	The effect of live load.
R	See Sec. 4.1.4.
R_I	Numerical coefficient related to the type of seismic-force-resisting system above the isolation system as defined in Sec. 13.3.3.2 for seismically isolated structures.
S_I	See Sec. 3.1.4.
S_{DI}	See Sec. 3.1.4.
S_{DS}	See Sec. 3.1.4.
S_{MI}	See Sec. 3.1.4.
T_D	Effective period, in seconds, of the seismically isolated structure at the design displacement in the direction under consideration as prescribed by Eq. 13.3-2.
T_M	Effective period, in seconds, of the seismically isolated structure at the maximum displacement in the direction under consideration as prescribed by Eq. 13.3-4.
V_b	The total lateral seismic design force on elements of the isolation system or elements below the isolation system as prescribed by Eq. 13.3-7.
V_s	The total lateral design force on elements above the isolation system as prescribed by Eq. 13.3-8.
W	See Sec. 1.1.5. For calculation of the period of seismically isolated structures, the seismic weight above the isolation system.
w_i	See Sec. 4.1.4.
w_x	See Sec. 1.1.5.
Level x	See Sec. 1.1.5.
y	The distance between the center of rigidity of the isolation system rigidity and the element of interest measured perpendicular to the direction of seismic loading under consideration.

β_D	Effective damping of the isolation system at the design displacement as prescribed by Eq. 13.6-7.
β_M	Effective damping of the isolation system at the maximum displacement as prescribed by Eq. 13.6-8.
β_{eff}	Effective damping of the isolation system as prescribed by Eq. 13.6-2.
Δ	The maximum considered earthquake lateral displacement of the structure above the isolation system.
Δ^+	Maximum positive displacement of an isolator unit during each cycle of prototype testing.
Δ^-	Maximum negative displacement of an isolator unit during each cycle of prototype testing.
ΣE_D	Total energy dissipated in the isolation system during a full cycle of response at the design displacement, D_D .
ΣE_M	Total energy dissipated on the isolation system during a full cycle of response at the maximum displacement, D_M .
$\Sigma F_D^+ _{max}$	Sum, for all isolator units, of the maximum absolute value of force at a positive displacement equal to D_D .
$\Sigma F_D^+ _{min}$	Sum, for all isolator units, of the minimum absolute value of force at a positive displacement equal to D_D .
$\Sigma F_D^- _{max}$	Sum, for all isolator units, of the maximum absolute value of force at a negative displacement equal to D_D .
$\Sigma F_D^- _{min}$	Sum, for all isolator units, of the minimum absolute value force at a negative displacement equal to D_D .
$\Sigma F_M^+ _{max}$	Sum, for all isolator units, of the maximum absolute value of force at a positive displacement equal to D_M .
$\Sigma F_M^+ _{min}$	Sum, for all isolator units, of the minimum absolute value of force at a positive displacement equal to D_M .
$\Sigma F_M^- _{max}$	Sum, for all isolator units, of the minimum absolute value of force at a negative displacement equal to D_M .
$\Sigma F_M^- _{min}$	Sum, for all isolator units, of the minimum absolute value of force at a negative displacement equal to D_M .

13.2 GENERAL DESIGN REQUIREMENTS

13.2.1 Occupancy importance factor. The Occupancy Importance Factor shall be taken as 1.0 for a seismically isolated structure, regardless of the Seismic Use Group assigned in accordance with Sec. 1.2.

13.2.2 Configuration. The determination of structural configuration in accordance with Sec. 4.3.2 shall be based on the structural configuration above the isolation system.

13.2.3 Ground motion

13.2.3.1 Design spectra. Properly substantiated site-specific spectra shall be used for the design of all seismically isolated structures located on a Class F site or located at a site with S_I greater than 0.6.

Where site-specific spectra are used, the design spectrum for the design earthquake shall be developed in accordance with Sec. 3.4. Where site-specific spectra are not used, the design spectrum for the design

earthquake shall be developed in accordance with Sec. 3.3. The design spectrum for the maximum considered earthquake shall be taken as not less than 1.5 times the design spectrum for the design earthquake.

13.2.3.2 Time histories. Where response history procedures are used, ground motions shall consist of pairs of appropriate horizontal ground motion acceleration components that shall be selected and scaled from individual recorded events. Appropriate ground motions shall be selected from events having magnitudes, fault distance, and source mechanisms that are consistent with those that control the maximum considered earthquake. Where the required number of recorded ground motion pairs are not available, appropriate simulated ground motion pairs shall be used to make up the total number required. For each pair of horizontal ground motion components, an SRSS spectrum shall be constructed by taking the square root of the sum of the squares of the five-percent-damped response spectra for the scaled components (where an identical scale factor is applied to both components of a pair). Each pair of motions shall be scaled such that for each period between $0.5T_D$ and $1.25T_M$ (where T_D and T_M are defined in Sec. 13.3.2) the average of the SRSS spectra from all horizontal component pairs does not fall below 1.3 times the corresponding ordinate of the design response spectrum, determined in accordance with Sec. 13.2.3.1, by more than 10 percent.

13.2.4 Procedure selection. All seismically isolated structures shall be designed using the procedure in Sec. 13.3 or one of the procedures in Sec. 13.4, as permitted in this section.

13.2.4.1 Equivalent lateral force procedure. The equivalent lateral force procedure of Sec. 13.3 is permitted to be used for design of a seismically isolated structure provided that:

1. The structure is located at a site with S_I less than or equal to 0.6 ;
2. The structure is located on a Class A, B, C, or D site;
3. The structure above the isolation interface is not more than four stories or 65 ft (20 m) in height;
4. The effective period of the isolated structure, T_M , is less than or equal to 3.0 sec.
5. The effective period of the isolated structure, T_D , is greater than three times the elastic, fixed-base period of the structure above the isolation system as determined in Sec. 5.2.2.1;
6. The structure above the isolation system is of regular configuration; and
7. The isolation system meets all of the following criteria:
 - a. The effective stiffness of the isolation system at the design displacement is greater than one third of the effective stiffness at 20 percent of the design displacement,
 - b. The isolation system is capable of producing a restoring force as specified in Sec. 13.2.5.4,
 - c. The isolation system does not limit maximum considered earthquake displacement to less than the total maximum displacement.

13.2.4.2 Dynamic procedures. The dynamic procedures of Sec. 13.4 are permitted to be used for design of seismically isolated structures as indicated in this section.

13.2.4.2.1 Response spectrum procedure. The response spectrum procedure is permitted to be used for design of a seismically isolated structure provided that:

1. The structure is located on a Class A, B, C, or D site, and
2. The isolation system meets the criteria of Item 7 of Sec. 13.2.4.1.

13.2.4.2.2 Response history procedure. The response history procedure is permitted to be used for design of any seismically isolated structure.

13.2.4.3 Variations in material properties. The analysis of seismically isolated buildings, including the substructure, isolators and superstructure, shall consider variations in seismic isolator material

properties over the projected life of the building including changes due to aging, contamination, environmental exposure, loading rate, scragging, and temperature.

13.2.5 Isolation system

13.2.5.1 Environmental conditions. In addition to satisfying the requirements related to vertical and lateral loads induced by wind and earthquake, the isolation system shall be designed with consideration given to other environmental conditions including aging effects, creep, fatigue, operating temperature, and exposure to moisture or damaging substances.

13.2.5.2 Wind forces. Isolated structures shall resist design wind loads at all levels above the isolation interface. At the isolation interface, a wind restraint system shall be provided to limit lateral displacement in the isolation system to a value equal to that required between floors of the structure above the isolation interface.

13.2.5.3 Fire resistance. The fire resistance rating for the isolation system shall be consistent with the requirements of columns, walls, or other such elements in the same area of the structure.

13.2.5.4 Lateral-restoring force. The isolation system shall be configured to produce a restoring force such that the lateral force at the total design displacement is at least $0.025W$ greater than the lateral force at 50 percent of the total design displacement.

13.2.5.5 Displacement restraint. The isolation system is permitted to be configured to include a displacement restraint that limits lateral displacement due to the maximum considered earthquake to less than S_{MI}/S_{DI} times the total design displacement if the seismically isolated structure is designed in accordance with the following criteria where more stringent than the other requirements of Sec. 13.2:

1. Maximum considered earthquake response is calculated in accordance with Sec. 13.4 including explicit consideration of the nonlinear characteristics of both the isolation system and the structure above the isolation system;
2. The ultimate capacities of the isolation system and structural elements below the isolation system shall exceed the strength and displacement demands due to the maximum considered earthquake;
3. The structure above the isolation system is adequate for the stability and ductility demands due to the maximum considered earthquake; and
4. The displacement restraint does not become effective at a displacement less than 0.75 times the total design displacement unless it is demonstrated by analysis that earlier engagement does not result in unsatisfactory performance.

13.2.5.6 Vertical-load stability. Each element of the isolation system shall be designed to be stable under the maximum vertical load ($1.2D + 1.0L + E$) and the minimum vertical load ($0.8D - E$) when subjected to a horizontal displacement equal to the total maximum displacement. The dead load, D , and the live load, L , are defined in Sec. 13.1.2. The effect of seismic load, E , shall be determined in accordance with Sec. 4.2.2.1 except that S_{MS} shall be used in place of S_{DS} and the vertical loads that result from application of horizontal seismic forces, Q_E , shall be based on peak response due to the maximum considered earthquake.

13.2.5.7 Overturning. The factor of safety against global structural overturning at the isolation interface shall not be less than 1.0 for required load combinations. All gravity and seismic loading conditions shall be investigated. Seismic forces for overturning calculations shall be based on the maximum considered earthquake and the vertical restoring force shall be based on W , the seismic weight above the isolation interface, as defined in Sec. 5.2.1.

Local uplift of individual elements is permitted if the resulting deflections do not cause overstress or instability of the isolator units or other elements of the structure.

13.2.5.8 Inspection and replacement

Access for inspection and replacement of all components of the isolation system shall be provided.

1. A registered design professional shall complete a final series of inspections or observations of structure separation areas and components that cross the isolation interface prior to the issuance of the certificate of occupancy for the seismically isolated structure. Such inspections and observations shall confirm that the conditions allow free and unhindered displacement of the structure to maximum design levels and that all components that cross the isolation interface as installed are able to accommodate the stipulated displacements.
2. The registered design professional responsible for the design of the isolation system shall establish a periodic monitoring, inspection, and maintenance program for such system.
3. Remodeling, repair, or retrofitting at the isolation interface, including that of components that cross the isolation interface, shall be performed under the direction of a registered design professional.

13.2.5.9 Quality control. As part of the quality assurance plan developed in accordance with Sec. 2.2.1, the registered design professional responsible for the structural design shall establish a quality control testing program for isolator units.

13.2.6 Structural system

13.2.6.1 Horizontal distribution of force. A horizontal diaphragm or other structural elements shall provide continuity above the isolation interface and shall have adequate strength and ductility to transmit forces (due to nonuniform ground motion) from one part of the structure to another.

13.2.6.2 Building separations. Minimum separations between the isolated structure and surrounding retaining walls or other fixed obstructions shall not be less than the total maximum displacement.

13.2.6.3 Nonbuilding structures. Nonbuilding structures shall be designed and constructed in accordance with the requirements of Chapter 14 using design displacements and forces calculated in accordance with this chapter.

13.2.7 Elements of structures and nonstructural components. Parts or portions of an isolated structure, permanent nonstructural components and the attachments to them, and the attachments for permanent equipment supported by a structure shall be designed to resist seismic forces and displacements as prescribed in this section and shall satisfy the applicable requirements of Chapter 6.

13.2.7.1 Components below the isolation interface. Elements of seismically isolated structures and nonstructural components, or portions thereof, that are below the isolation interface shall be designed for the forces and displacements indicated in Chapter 4 or Chapter 6, as appropriate.

13.2.7.2 Components crossing the isolation interface. Elements of seismically isolated structures and nonstructural components, or portions thereof, that cross the isolation interface shall be designed to withstand the total maximum displacement.

13.2.7.3 Components at or above the isolation interface. Elements of seismically isolated structures and nonstructural components, or portions thereof, that are at or above the isolation interface shall be designed to resist a total lateral force consistent with the maximum dynamic response of the element or component under consideration.

Exception: Elements of seismically isolated structures and nonstructural components or portions thereof are permitted to be designed for the forces and displacements indicated in Chapter 4 or Chapter 6, as appropriate.

13.3 EQUIVALENT LATERAL FORCE PROCEDURE

Where the equivalent lateral force procedure is used to design seismically isolated structures, the requirements of this section shall apply.

13.3.1 Deformational characteristics of the isolation system. Minimum lateral earthquake design displacement and forces on seismically isolated structures shall be based on the deformational characteristics of the isolation system. The deformational characteristics of the isolation system shall explicitly include the effects of the wind-restraint system if such a system is used to meet the design requirements of these *Provisions*. The deformational characteristics of the isolation system shall be based on properly substantiated tests performed in accordance with Sec. 13.6.

13.3.2 Minimum lateral displacements

13.3.2.1 Design displacement. The isolation system shall be designed and constructed to withstand minimum lateral earthquake displacements that act in the direction of each of the main horizontal axes of the structure and such displacements shall be calculated in accordance with Eq. 13.3-1 as follows:

$$D_D = \left(\frac{g}{4\pi^2} \right) \frac{S_{DI} T_D}{B_D} \quad (13.3-1)$$

where:

- g = acceleration due to gravity.
- S_{DI} = design five-percent-damped spectral acceleration parameter at one second period as determined in Chapter 3.
- T_D = effective period of seismically isolated structure at the design displacement in the direction under consideration, as prescribed by Eq. 13.3-2.
- B_D = numerical coefficient related to the effective damping of the isolation system at the design displacement, β_D , as set forth in Table 13.3-1.

Table 13.3-1 Damping Coefficient, B_D or B_M

Effective Damping, β_D or β_M (Percentage of Critical) ^{a,b}	B_D or B_M Factor
≤ 2	0.8
5	1.0
10	1.2
20	1.5
30	1.7
40	1.9
≥ 50	2.0
^a The damping coefficient shall be based on the effective damping of the isolation system determined in accordance with the requirements of Sec. 13.6.4.2. ^b The damping coefficient shall be based on linear interpolation for effective damping values other than those given.	

13.3.2.2 Effective period at design displacement. The effective period of the isolated structure, T_D , shall be determined using Eq. 13.3-2 as follows:

$$T_D = 2\pi \sqrt{\frac{W}{k_{Dmin} g}} \quad (13.3-2)$$

where:

- W = seismic weight above the isolation interface as defined in Sec. 5.2.1.
- k_{Dmin} = minimum effective stiffness of the isolation system at the design displacement in the horizontal direction under consideration as prescribed by Eq. 13.6-4.
- g = acceleration due to gravity.

13.3.2.3 Maximum displacement. The maximum displacement of the isolation system, D_M , in the most critical direction of horizontal response shall be calculated in accordance with Eq. 13.3-3 as follows:

$$D_M = \left(\frac{g}{4\pi^2} \right) \frac{S_{MI} T_M}{B_M} \quad (13.3-3)$$

where:

- g = acceleration due to gravity.
- S_{MI} = maximum considered five-percent-damped spectral acceleration parameter at 1 sec period as determined in Chapter 3.
- T_M = effective period of seismic-isolated structure at the maximum displacement in the direction under consideration as prescribed by Eq. 13.3-4.
- B_M = numerical coefficient related to the effective damping of the isolation system at the maximum displacement, β_M , as set forth in Table 13.3-1.

13.3.2.4 Effective period at maximum displacement. The effective period of the isolated structure at maximum displacement, T_M , shall be determined using Eq. 13.3-4 as follows:

$$T_M = 2\pi \sqrt{\frac{W}{k_{Mmin} g}} \quad (13.3-4)$$

where:

- W = seismic weight above the isolation interface as defined in Sec. 5.2.1.
- k_{Mmin} = minimum effective stiffness of the isolation system at the maximum displacement in the horizontal direction under consideration as prescribed by Eq. 13.6-6.
- g = acceleration due to gravity.

13.3.2.5 Total displacements. The total design displacement, D_{TD} , and the total maximum displacement, D_{TM} , of elements of the isolation system shall include additional displacement due to inherent and accidental torsion calculated considering the spatial distribution of the lateral stiffness of the isolation system and the most disadvantageous location of eccentric mass.

The total design displacement, D_{TD} , and the total maximum displacement, D_{TM} , of elements of an isolation system with uniform spatial distribution of lateral stiffness shall not be taken less than that prescribed by Eq. 13.3-5 and Eq. 13.3-6, respectively, as follows:

$$D_{TD} = D_D \left[1 + y \left(\frac{12e}{b^2 + d^2} \right) \right] \quad (13.3-5)$$

$$D_{TM} = D_M \left[1 + y \left(\frac{12e}{b^2 + d^2} \right) \right] \quad (13.3-6)$$

where:

D_D = design displacement at the center of rigidity of the isolation system in the direction under consideration as prescribed by Eq. 13.3-1.

D_M = maximum displacement at the center of rigidity of the isolation system in the direction under consideration as prescribed in Eq. 13.3-3.

y = the distance between the center of rigidity of the isolation system and the element of interest measured perpendicular to the direction of seismic loading under consideration.

e = the actual horizontal eccentricity between the center of mass of the structure above the isolation interface and the center of rigidity of the isolation system, plus the accidental eccentricity, taken as 5 percent of the longest plan dimension of the structure perpendicular to the direction of force under consideration.

b = the shortest plan dimension of the structure measured perpendicular to d .

d = the longest plan dimension of the structure.

Exception: The total design displacement, D_{TD} , and the total maximum displacement, D_{TM} , are permitted to be taken less than the values prescribed by Eq. 13.3-5 and Eq. 13.3-6, respectively, but not less than 1.1 times D_D and D_M , respectively, if the isolation system is shown by calculation to be configured to resist torsion accordingly.

13.3.3 Minimum lateral forces

13.3.3.1 Isolation system and structural elements below the isolation system. The isolation system, the foundation, and all structural elements below the isolation system shall be designed and constructed to withstand a minimum lateral force, V_b , using all of the appropriate provisions for a nonisolated structure. V_b shall be determined in accordance with Eq. 13.3-7 as follows:

$$V_b = k_{Dmax} D_D \quad (13.3-7)$$

where:

k_{Dmax} = maximum effective stiffness of the isolation system at the design displacement in the horizontal direction under consideration as prescribed by Eq. 13.6-3.

D_D = design displacement at the center of rigidity of the isolation system in the direction under consideration as prescribed by Eq. 13.3-1.

In all cases, V_b shall not be taken less than the maximum force in the isolation system at any displacement up to and including the design displacement.

13.3.3.2 Structural elements above the isolation system. The structure above the isolation system shall be designed and constructed to withstand a minimum lateral force, V_s , using all of the appropriate provisions for a nonisolated structure. V_s shall be determined in accordance with Eq. 13.3-8 as follows:

$$V_s = \frac{k_{Dmax} D_D}{R_I} \quad (13.3-8)$$

where:

k_{Dmax} = maximum effective stiffness of the isolation system at the design displacement in the horizontal direction under consideration as prescribed by Eq. 13.6-3.

- D_D = design displacement at the center of rigidity of the isolation system in the direction under consideration as prescribed by Eq. 13.3-1.
- R_I = numerical coefficient related to the type of seismic-force-resisting system above the isolation system.

R_I shall be based on the type of seismic-force-resisting system used for the structure above the isolation system and shall be taken as the lesser of 2.0 or 3/8 of the R value given in Table 4.3-1, but need not be taken less than 1.0.

In no case shall V_s be taken less than the following:

1. The lateral force required by Sec. 5.2 for a fixed-base structure of the same weight, W , and a period equal to the isolated period, T_D ;
2. The base shear corresponding to the factored design wind load; and
3. The lateral force required to fully activate the isolation system (e.g., the yield level of a softening system, the ultimate capacity of a sacrificial wind-restraint system, or the break-away friction level of a sliding system) multiplied by 1.5.

13.3.4 Vertical distribution of forces. The total force shall be distributed over the height of the structure above the isolation interface in accordance with Eq. 13.3-9 as follows:

$$F_x = V_s \frac{w_x h_x}{\sum_{i=1}^n w_i h_i} \quad (13.3-9)$$

where:

- V_s = total lateral design force on elements above the isolation system.
- W_x = portion of W that is located at or assigned to Level x .
- h_x = height above the base Level x .
- w_i, w_x = portion of W that is located at or assigned to Level i or Level x , respectively.
- h_i = height, above the base, to Level i .

At each Level x the force, F_x , shall be applied over the area of the structure in accordance with the distribution of mass at the level. Stresses in each structural element shall be determined by applying to an analytical model the lateral forces, F_x , at all levels above the base.

13.3.5 Drift limits. The drift limits specified in this section shall supercede those found in Sec. 4.5.1. The maximum story drift of the structure above the isolation system shall not exceed $0.015h_{sx}$. The drift shall be calculated using Eq. 5.2-15 except that C_d for the isolated structure shall be taken equal to R_I as defined in Sec. 13.3.3.2.

13.4 DYNAMIC PROCEDURES

Where dynamic analysis is used to design seismically isolated structures, the requirements of this section shall apply.

13.4.1 Modeling. The mathematical models of the isolated structure including the isolation system, the seismic-force-resisting system, and other structural elements shall be developed in accordance with Sec. 5.3.1 and this section.

13.4.1.1 Isolation system. The isolation system shall be modeled using deformational characteristics developed and verified by testing in accordance with the requirements of Sec. 13.3.1. The isolation system shall be modeled with sufficient detail to:

1. Account for the spatial distribution of isolator units;

2. Calculate translation, in both horizontal directions, and torsion of the structure above the isolation interface considering the most disadvantageous location of eccentric mass;
3. Assess overturning/uplift forces on individual isolator units; and
4. Account for the effects of vertical load, bilateral load, and the rate of loading if the force-deflection properties of the isolation system are dependent on such attributes.

The total design displacement and total maximum displacement across the isolation system shall be calculated using a model of the isolated structure that incorporates the force-deflection characteristics of nonlinear elements of the isolation system and the seismic-force-resisting system.

13.4.1.2 Isolated structure

The maximum displacement of each floor and design forces and displacements in elements of the seismic-force-resisting system are permitted to be calculated using a linear elastic model of the isolated structure provided that:

1. Stiffness properties assumed for the nonlinear components of the isolation system are based on the maximum effective stiffness of the isolation system, and
2. No elements of the seismic-force-resisting system of the structure above the isolation system are nonlinear.

Seismic-force-resisting systems with nonlinear elements include, but are not limited to, irregular structural systems designed for a lateral force less than 100 percent of V_s and regular structural systems designed for a lateral force less than 80 percent of V_s , where V_s is determined in accordance with Sec. 13.3.3.2.

13.4.2 Description of procedures. The response spectrum procedure, linear response history procedure, and nonlinear response history procedure shall be performed in accordance with Sec. 5.3, 5.4, and 5.5, respectively, and the requirements of this section.

13.4.2.1 Input earthquake. The design earthquake shall be used to calculate the total design displacement of the isolation system and the lateral forces and displacements of the isolated structure. The maximum considered earthquake shall be used to calculate the total maximum displacement of the isolation system.

13.4.2.2 Response spectrum procedure. Response spectrum analysis shall be performed using a modal damping value for the fundamental mode in the direction of interest not greater than the effective damping of the isolation system or 30 percent of critical, whichever is less. Modal damping values for higher modes shall be selected consistent with those that would be appropriate for response spectrum analysis of the structure above the isolation system assuming a fixed base.

Response spectrum analysis used to determine the total design displacement and the total maximum displacement shall include simultaneous excitation of the model by 100 percent of the ground motion in the critical direction and 30 percent of the ground motion in the perpendicular, horizontal direction. The maximum displacement of the isolation system shall be calculated as the vectorial sum of the two orthogonal displacements.

The design shear at any story shall not be less than the story shear resulting from application of the story forces calculated using Eq. 13.3-9 and a value of V_s equal to the base shear obtained from the response-spectrum analysis in the direction of interest.

13.4.2.3 Response history procedure. Where a response history procedure is performed, a suite of not fewer than three appropriate ground motions shall be used in the analysis and the ground motions shall be selected and scaled in accordance with Sec. 13.2.3.2. Each pair of ground motion components shall be applied to the model considering the most disadvantageous location of eccentric mass. The

maximum displacement of the isolation system shall be calculated from the vectorial sum of the two orthogonal displacement components at each time step.

For each ground motion analyzed, the parameters of interest shall be calculated. If at least seven ground motions are analyzed, the average value of the response parameter of interest shall be permitted to be used for design. If fewer than seven ground motions are analyzed, the maximum value of the response parameter of interest shall be used for design.

13.4.3 Minimum lateral displacements and forces

13.4.3.1 Isolation system and structural elements below the isolation system. The isolation system, the foundation, and all structural elements below the isolation system shall be designed and constructed using all of the appropriate requirements for a nonisolated structure and the forces obtained from the dynamic analysis without reduction, but the design lateral force shall not be taken less than 90 percent of V_b determined in accordance with Sec. 13.3.3.1.

The total design displacement of the isolation system shall be taken as not less than 90 percent of D_{TD} . The total maximum displacement of the isolation system shall be taken as not less than 80 percent of D_{TM} . These limits shall be evaluated using values of D_{TD} and D_{TM} determined in accordance with Sec. 13.3.2.5 except that D'_D and D'_M , as calculated using Eq. 13.4-1 and 13.4-2, shall be permitted to be used in lieu of D_D and D_M , respectively.

$$D'_D = \frac{D_D}{\sqrt{1 + \left(\frac{T}{T_D}\right)^2}} \quad (13.4-1)$$

$$D'_M = \frac{D_M}{\sqrt{1 + \left(\frac{T}{T_M}\right)^2}} \quad (13.4-2)$$

where:

- D_D = design displacement at the center of rigidity of the isolation system in the direction under consideration, determined in accordance with Sec. 13.3.2.1.
- D_M = maximum displacement at the center of rigidity of the isolation system in the direction under consideration, determined in accordance with Sec. 13.3.2.3.
- T = elastic, fixed-base period of the structure above the isolation system, determined in accordance with Sec. 5.2.2.
- T_D = effective period of the seismically isolated structure at the design displacement in the direction under consideration, determined in accordance with Sec. 13.3.2.2.
- T_M = effective period of the seismically isolated structure at the maximum displacement in the direction under consideration, determined in accordance with Sec. 13.3.2.4.

13.4.3.2 Structural elements above the isolation system. Subject to the procedure-specific limits of this section, structural elements above the isolation system shall be designed using the appropriate provisions for a nonisolated structure and the forces obtained from the dynamic analysis divided by R_I , where R_I is determined in accordance with Sec. 13.3.3.2.

Where the response spectrum procedure is used and the structure is regular in configuration, the design lateral force on the structure above the isolation system shall be taken as not less than 80 percent of V_s as determined in accordance with Sec. 13.3.3.2. Where the response spectrum procedure is used and the

structure is irregular in configuration, the design lateral force on the structure above the isolation system shall be taken as not less than 100 percent of V_s as determined in accordance with Sec. 13.3.3.2.

Where the response history procedure is used and the structure is regular in configuration, the design lateral force on the structure above the isolation system shall be taken as not less than 60 percent of V_s as determined in accordance with Sec. 13.3.3.2. Where the response history procedure is used and the structure is irregular in configuration, the design lateral force on the structure above the isolation system shall be taken as not less than 80 percent of V_s as determined in accordance with Sec. 13.3.3.2.

13.4.3.3 Scaling of results. Where the design lateral force on structural elements, determined using either the response spectrum or response history procedure, is less than the minimum level required by Sec. 13.4.3.1 and 13.4.3.2, all response parameters, including member forces and moments, shall be adjusted proportionally upward.

13.4.4 Drift limits. The drift limits specified in this section shall supercede those found in Sec. 4.5.1. The maximum story drift of the structure above the isolation system corresponding to the design lateral force, including displacement due to vertical deformation of the isolation system, shall not exceed $0.015h_{sx}$ where the response spectrum procedure is used, or $0.020h_{sx}$ where the response history procedure is used.

Drift shall be calculated using Eq. 5.3-8 with C_d for the isolated structure taken equal to R_f as defined in Sec. 13.3.3.2.

The secondary effects of the maximum considered earthquake lateral displacement, Δ , of the structure above the isolation system combined with gravity forces shall be investigated if the story drift ratio exceeds $0.010/R_f$.

13.5 DESIGN REVIEW

A design review of the isolation system and related test programs shall be performed by an independent team of registered design professionals in the appropriate disciplines and others experienced in seismic analysis methods and the theory and application of seismic isolation. Isolation system design review shall include, but need not be limited to, the following:

1. Review of site-specific seismic criteria including the development of site-specific spectra and ground motion time histories and all other design criteria developed specifically for the project;
2. Review of the preliminary design including the determination of the total design displacement of the isolation system and the lateral force design level;
3. Overview and observation of prototype testing, performed in accordance with Sec. 13.6;
4. Review of the final design of the entire structural system and all supporting analyses; and
5. Review of the isolation system quality control testing program developed in accordance with Sec. 13.2.5.9.

13.6 TESTING

The deformation characteristics and damping values of the isolation system used in the analysis and design of seismically isolated structures shall be based on tests of a selected sample of the components prior to construction as described in this section.

The isolation system components to be tested shall include the wind-restraint system if such a system is used in the design.

The tests specified in this section are for establishing and validating the design properties of the isolation system and shall not be considered as satisfying the manufacturing quality control tests of Sec. 13.2.5.9.

13.6.1 Prototype tests. Prototype tests shall be performed separately on two full-size specimens (or sets of specimens, as appropriate) for each predominant type and size of isolator unit of the isolation system. The test specimens shall include the wind restraint system as well as individual isolator units if such system is used in the design. Specimens tested shall not be used for construction unless accepted by the registered design professional.

13.6.1.1 Record. For each cycle of tests, the force-deflection behavior of the test specimen shall be recorded.

13.6.1.2 Sequence and cycles. For all isolator units of a common type and size, the following sequence of tests shall be performed for the prescribed number of cycles while the test specimen is subjected to a vertical load equal to the average dead load plus one-half the average live load:

1. Twenty fully reversed cycles of loading at a lateral force corresponding to the wind design force;
2. Three fully reversed cycles of loading at each of the following increments of displacement: $0.25D_D$, $0.5D_D$, $1.0D_D$, and $1.0D_M$;
3. Three fully reversed cycles of loading at the total maximum displacement, D_{TM} ; and
4. $30S_{D1}/B_D S_{DS}$ but not less than ten, fully reversed cycles of loading at the total design displacement, D_{TD} .

If an isolator unit is also a vertical-load-carrying element, then Item 2 of the sequence of cyclic tests specified above shall be performed for two additional vertical load cases: 1) $1.2D + 0.5L + |E|$ and 2) $0.8D - |E|$, where each vertical load case is based on the average downward force on all isolator units of a common type and size. The dead load, D , and the live load, L , are defined in Sec. 13.1.2. The effect of seismic load, E , shall be determined in accordance with Sec. 4.2.2.1 and the vertical loads that result from application of horizontal seismic forces, Q_E , shall be based on peak response corresponding to the test displacement being evaluated.

13.6.1.3 Units dependent on loading rates. If the force-deflection properties of the isolator units are dependent on the rate of loading, then each set of tests specified in Sec. 13.6.1.2 shall be performed dynamically at a frequency equal to the inverse of the effective period of the isolated structure, T_D . The force-deflection properties of an isolator unit shall be considered to be dependent on the rate of loading if the measured property (effective stiffness or effective damping) at the design displacement where tested at any frequency in the range of 0.1 to 2.0 times the inverse of T_D is different from the property where tested at a frequency equal to the inverse of T_D by more than 15 percent.

If reduced-scale prototype specimens are used to quantify rate-dependent properties of isolators, the reduced-scale prototype specimens shall be of the same type and material and be manufactured with the same processes and quality as full-scale prototypes and shall be tested at a frequency that represents full-scale prototype loading rates.

13.6.1.4 Units dependent on bilateral load. If the force-deflection properties of the isolator units are dependent on bilateral load, the tests specified in Sec. 13.6.1.2 and 13.6.1.3 shall be augmented to include bilateral load at the following increments of the total design displacement, D_{TD} : 0.25 and 1.0, 0.50 and 1.0, 0.75 and 1.0, and 1.0 and 1.0. The force-deflection properties of an isolator unit shall be considered to be dependent on bilateral load if the effective stiffness where subjected to bilateral loading is different from the effective stiffness where subjected to unilateral loading by more than 15 percent.

If reduced-scale prototype specimens are used to quantify bilateral-load-dependent properties, then such specimens shall be of the same type and material and manufactured with the same processes and quality as full-scale prototypes.

13.6.1.5 Maximum and minimum vertical load. In addition to the cyclic testing requirements of Sec. 13.6.1.2, isolator units that are vertical-load-carrying elements shall be statically tested by subjecting them to the total maximum displacement while under the maximum and minimum vertical

load. In these tests, the maximum vertical load shall be taken as the maximum effect of $1.2D + 1.0L + |E|$ and the minimum vertical load shall be taken as the minimum effect of $0.8D - |E|$ for any one isolator of a common type and size. The dead load, D , and the live load, L , are defined in Sec. 13.1.2. The effect of seismic load, E , shall be determined in accordance with Sec. 4.2.2.1 except that S_{MS} shall be used in place of S_{DS} and the vertical loads that result from application of horizontal seismic forces, Q_E , shall be based on peak response due to the maximum considered earthquake.

13.6.1.6 Sacrificial wind-restraint systems. If a sacrificial wind-restraint system is to be utilized, the ultimate capacity shall be established by test.

13.6.1.7 Testing similar units. The prototype tests are not required if an isolator unit is of similar dimensional characteristics and of the same type and material as a prototype isolator unit that has been previously tested using the specified sequence of tests.

13.6.2 Determination of force-deflection characteristics. The force-deflection characteristics of the isolation system shall be based on the cyclic load tests of isolator prototypes specified in Sec. 13.6.1.

As required, the effective stiffness of an isolator unit, k_{eff} , shall be calculated for each cycle of loading by Eq. 13.6-1 as follows:

$$k_{eff} = \frac{|F^+| + |F^-|}{|\Delta^+| + |\Delta^-|} \quad (13.6-1)$$

where F^+ and F^- are the positive and negative forces at Δ^+ and Δ^- , respectively.

As required, the effective damping, β_{eff} , of an isolator unit shall be calculated for each cycle of loading by Eq. 13.6-2 as follows:

$$\beta_{eff} = \frac{2}{\pi} \left[\frac{E_{loop}}{k_{eff} (|\Delta^+| + |\Delta^-|)^2} \right] \quad (13.6-2)$$

where the energy dissipated per cycle of loading, E_{loop} , and the effective stiffness, k_{eff} , shall be based on peak test displacements of Δ^+ and Δ^- .

13.6.3 Test specimen adequacy. The performance of the test specimens shall be deemed adequate if the following conditions are satisfied:

1. The force-deflection plots for all tests specified in Sec. 13.6.1 have a positive incremental force carrying capacity. For each increment of test displacement specified in Item 2 of Sec. 13.6.1.2 and for each vertical load case specified in Sec. 13.6.1.2,
 - a. For each test specimen, the difference between the effective stiffness at each of the three cycles of test and the average value of effective stiffness is no greater than 15 percent; and
 - b. For each cycle of test, the difference between effective stiffness of the two test specimens of a common type and size of the isolator unit and the average effective stiffness is no greater than 15 percent.
2. For each specimen there is no greater than a 20 percent change in the initial effective stiffness over the cycles of test specified in Item 4 of Sec. 13.6.1.2;
3. For each specimen there is no greater than a 20 percent decrease in the initial effective damping over the cycles of test specified in Item 4 of Sec. 13.6.1.2; and
4. All specimens of vertical-load-carrying elements of the isolation system remain stable when tested in accordance with Sec. 13.6.1.5.

13.6.4 Design properties of the isolation system

13.6.4.1 Maximum and minimum effective stiffness. At the design displacement, the maximum and minimum effective stiffness of the entire isolated system, k_{Dmax} and k_{Dmin} , shall be based on the cyclic tests of individual isolator units in accordance with Item 2 of Sec. 13.6.1.2 and calculated using Eq. 13.6-3 and 13.6-4 as follows:

$$k_{Dmax} = \frac{\sum |F_D^+|_{max} + \sum |F_D^-|_{max}}{2D_D} \quad (13.6-3)$$

$$k_{Dmin} = \frac{\sum |F_D^+|_{min} + \sum |F_D^-|_{min}}{2D_D} \quad (13.6-4)$$

At the maximum displacement, the maximum and minimum effective stiffness of the entire isolation system, k_{Mmax} and k_{Mmin} , shall be based on the cyclic tests of individual isolator units in accordance with Item 2 of Sec. 13.6.1.2 and calculated using Eq. 13.6-5 and 13.6-6 as follows:

$$k_{Mmax} = \frac{\sum |F_M^+|_{max} + \sum |F_M^-|_{max}}{2D_M} \quad (13.6-5)$$

$$k_{Mmin} = \frac{\sum |F_M^+|_{min} + \sum |F_M^-|_{min}}{2D_M} \quad (13.6-6)$$

The maximum effective stiffness of the isolation system, k_{Dmax} (or k_{Mmax}), shall be based on forces from the cycle of prototype testing at a test displacement equal to D_D (or D_M) that produces the largest value of effective stiffness. Minimum effective stiffness of the isolation system, k_{Dmin} (or k_{Mmin}), shall be based on forces from the cycle of prototype testing at a test displacement equal to D_D (or D_M) that produces the smallest value of effective stiffness.

For isolator units that are found by the tests of Sec. 13.6.1.2, 13.6.1.3 and 13.6.1.4 to have force-deflection characteristics that vary with vertical load, rate of loading, or bilateral load, respectively, the values of k_{Dmax} and k_{Mmax} shall be increased and the values of k_{Dmin} and k_{Mmin} shall be decreased to bound the effects of measured variation in effective stiffness.

13.6.4.2 Effective damping. At the design displacement, the effective damping of the entire isolation system, β_D , shall be based on the cyclic tests of individual isolator units in accordance with Item 2 of Sec. 13.6.1.2 and calculated using Eq. 13.6-7 as follows:

$$\beta_D = \frac{1}{2\pi} \left(\frac{\sum E_D}{k_{Dmax} D_D^2} \right) \quad (13.6-7)$$

In Eq. 13.6-7, the total energy dissipated per cycle of design displacement response, $\sum E_D$, shall be taken as the sum of the energy dissipated per cycle in all isolator units measured at a test displacement equal to D_D , and shall be based on forces and deflections from the cycle of prototype testing that produces the smallest value of effective damping.

At the maximum displacement, the effective damping of the entire isolation system, β_M , shall be based on the cyclic tests of individual isolator units in accordance with Item 2 of Sec. 13.6.1.2 and calculated using Eq. 13.6-8 as follows:

$$\beta_M = \frac{1}{2\pi} \left(\frac{\sum E_M}{k_{Mmax} D_M^2} \right) \quad (13.6-8)$$

In Eq. 13.6-8, the total energy dissipated per cycle of maximum displacement response, ΣE_M , shall be taken as the sum of the energy dissipated per cycle in all isolator units measured at a test displacement equal to D_M , and shall be based on forces and deflections from the cycle of prototype testing that produces the smallest value of effective damping.

Chapter 14

NONBUILDING STRUCTURE DESIGN REQUIREMENTS

14.1 GENERAL

14.1.1 Scope. Nonbuilding structures considered by these *Provisions* include all self-supporting structures which carry gravity loads, with the exception of buildings, vehicular and railroad bridges, electric power substation equipment, overhead power line support structures, buried pipelines, conduits and tunnels, lifeline systems, nuclear power generation plants, offshore platforms, and dams. Nonbuilding structures supported by the earth or by other structures shall be designed and detailed in accordance with these *Provisions* as modified by this chapter. Nonbuilding structures for which this chapter does not provide explicit direction shall be designed in accordance with engineering practices that are approved by the authority having jurisdiction and are applicable to the specific type of nonbuilding structure.

Architectural, mechanical, and electrical components supported by nonbuilding structures within the scope of chapter 14, and their supports and attachments, shall be designed in accordance with Chapter 6 of these *Provisions*.

Exception: Storage racks, cooling towers, and storage tanks shall be designed in accordance with Chapter 14 of these *Provisions*.

14.1.2 References

14.1.2.1 Adopted references. The following references form a part of these *Provisions* to be used for the applications indicated in Table 14.1-1 as specified in this chapter.

ACI 313	<i>Standard Practice for the Design and Construction of Concrete Silos and Stacking Tubes for Storing Granular Materials</i> , American Concrete Institute, 1997.
ACI 350.3	<i>Seismic Design of Liquid-Containing Concrete Structures</i> , American Concrete Institute, 2001.
API 620	<i>Design and Construction of Large, Welded, Low Pressure Storage Tanks</i> , American Petroleum Institute, 2002.
API 650	<i>Welded Steel Tanks For Oil Storage</i> , American Petroleum Institute, 1998.
ASME BPV	<i>Boiler And Pressure Vessel Code</i> , American Society of Mechanical Engineers, including addenda through 2003.
AWWA D100	<i>Welded Steel Tanks for Water Storage</i> , American Water Works Association, 1996.
AWWA D103	<i>Factory-Coated Bolted Steel Tanks for Water Storage</i> , American Water Works Association, 1997.
AWWA D110	<i>Wire- and Strand-Wound Circular Prestressed Concrete Water Tanks</i> , American Water Works Association, 1995.
AWWA D115	<i>Circular Prestressed Concrete Tanks with Circumferential Tendons</i> , American Water Works Association, 1995.
RMI	<i>Specification for the Design, Testing, and Utilization of Industrial Steel Storage Racks</i> , Rack Manufacturers Institute, 1997 (Reaffirmed 2002).

NCEL R-939 Ebeling, R. M., and Morrison, E. E., *The Seismic Design of Waterfront Retaining Structures*, Naval Civil Engineering Laboratory, 1993.

Table 14.1-1 Adopted References

Application	Reference
Steel storage racks	RMI
Welded steel tanks for water storage	AWWA D100
Welded steel tanks for petroleum and petrochemical storage	API 650, API 620
Bolted steel tanks for water storage	AWWA D103
Piers and Wharves	
Concrete tanks for water storage	AWWA D115, AWWA D110, ACI 350.3
Pressure vessels	ASME BPV
Concrete silos and stacking tubes	ACI 313

14.1.2.2 Other references

ACI 371R *Guide for the Analysis, Design, and Construction of Concrete Pedestal Water Towers*, American Concrete Institute, 1998.

API 653 *Tank Inspection, Repair, Alteration, and Reconstruction*, American Petroleum Institute, 2001.

API Spec 12B *Bolted Tanks for Storage of Production Liquids*, American Petroleum Institute, 1995 (Reaffirmed 2000).

14.1.3 Definitions

Attachments: See Sec. 6.1.3.

Base: See Sec. 4.1.3.

Base shear: See Sec. 4.1.3.

Building: See Sec. 4.1.3.

Component: See Sec. 1.1.4.

Container: A large-scale independent component used as a receptacle or a vessel to accommodate plants, refuse, or similar uses.

Dead load: See Sec. 4.1.3.

Diaphragm: See Sec. 4.1.3.

Flexible component: See Sec. 6.1.3.

Flexible equipment connections: Those connections between equipment components that permit rotational and/or transitional movement without degradation of performance. Examples included universal joints, bellows, expansion joints, and flexible metal hose.

Live load: See Sec. 4.1.3.

Maximum considered earthquake ground motion: See Sec. 3.1.3.

Nonbuilding structure: A structure, other than a building, constructed of a type included in Chapter 14 and within the limits of Sec. 14.1.1.

Nonbuilding structure similar to building: A nonbuilding structure that is designed and constructed in a manner similar to buildings, with a basic seismic-force-resisting-system conforming to one of the types indicated in Table 4.3-1, usually with diaphragms or other elements to transfer lateral forces to the vertical seismic force resisting system.

Occupancy importance factor: See Sec. 1.1.4.

P-delta effect: See Sec. 5.1.2.

Plain masonry: See Sec. 11.1.3.

Reinforced masonry: See Sec. 11.1.3.

Rigid component: See Sec. 6.1.3.

Seismic Design Category: See Sec. 1.1.4.

Seismic force-resisting system: See Sec. 1.1.4.

Seismic forces: See Sec. 1.1.4.

Seismic Use Group: A classification assigned to the structure based on its use as defined in Sec. 1.3.

Storage racks: Industrial pallet racks, moveable shelf racks, and stacker racks made of cold-formed and hot-rolled structural members. Other types of racks such as drive-in and drive-through racks, cantilever racks, portable racks, or racks made of materials other than steel are not included.

Structure: See Sec. 1.1.4.

Supports: See Sec. 6.1.3.

14.1.4 Notation.

A_g See Sec. 7.1.4.

B Inside length of a rectangular tank, perpendicular to the direction of the earthquake force being investigated.

a_p See Sec. 6.1.4.

C_d See Sec. 4.1.4.

C_v A coefficient defined in 14.4.7.1(3) [Eq. (14.4-2)].

D See Sec. 4.1.4.

D_i Inside diameter of tank or vessel.

E See Sec. 4.1.4.

E_t Modulus of elasticity of tank or vessel wall material.

F_h Total unbalanced lateral dynamic earth and groundwater pressure acting on the outer wall of the tank or vessel.

F_y The yield stress.

g See Sec. 13.1.3.

H The height of liquid in a tank.

H_L Design liquid height inside tank or vessel.

H_w Height of tank or vessel wall (shell).

h Depth of tank wall embedment.

h_i, h_x The height above the base Level i or x , respectively.

I See Sec. 1.1.5.

I_p See Sec. 6.1.4.

k See Sec. 5.1.3.

k_h	Horizontal ground acceleration (as used in the design of buried tanks and vessels).
L	Inside length of a rectangular tank, parallel to the direction of the earthquake force being investigated.
M	Overturning moment.
N_h	Hydrodynamic hoop force in the wall of a cylindrical tank or vessel
R	See Sec. 4.1.4.
R_p	See Sec. 6.1.4.
S_a	See Sec. 3.1.4.
S_{ac}	The design spectral response acceleration for a convective mode.
S_{ai}	The design spectral response acceleration for an impulsive mode.
S_{DI}	See Sec. 3.1.4.
S_{DS}	See Sec. 3.1.4.
T	See Sec. 4.1.4.
T_0	See Sec. 3.1.4.
T_c	The natural period of the first convective mode.
T_i	The natural period of the first impulsive mode.
T_S	See Sec. 3.1.4.
T_v	The natural period of vertical vibration of the liquid and tank structural system.
t_w	Thickness of tank or vessel wall.
V	See Sec. 5.1.3.
V_c	The total convective shear at the base of the structure in the direction of interest.
V_i	The total impulsive shear at the base of the structure in the direction of interest.
V_{max}	The peak local tangential shear per unit length as determined by Eq. 14.4-10.
\tilde{V}	See Sec. 5.1.3.
W	See Sec. 1.1.5.
W_c	The convective component of seismic weight.
W_i	The impulsive component of seismic weight.
W_L	Weight of the stored liquid.
W_p	See Sec. 6.1.4.
W_r	Weight of the tank roof.
W_w	Weight of the tank or vessel wall (shell).
y	Distance from base of the tank to level being investigated.
γ_L	Unit weight of stored liquid.
δ_s	The height of a sloshing wave.
δ_x	See Sec. 4.1.4.
δ_{xe}	The deflection of Level x at the center of the mass at and above Level x determined by an elastic analysis.

ρ See Sec. 4.1.4.

Ω_0 See Sec. 4.1.4.

14.1.5 Nonbuilding structures supported by other structures. If a nonbuilding structure is supported above the base by another structure and the weight of the nonbuilding structure is not more than 25 percent of the seismic weight, W , as defined in Sec. 5.2.1, the design seismic forces for the supported nonbuilding structure shall be determined in accordance with the requirements of Chapter 6.

Exception: Storage racks, cooling towers, and storage tanks shall be designed in accordance with Chapter 14 of these *Provisions*.

If the weight of a supported nonbuilding structure is more than 25 percent of the seismic weight, W , as defined in Sec. 5.2.1, the design seismic forces shall be determined based on an analysis of the combined system (comprising the nonbuilding structure and supporting structure). For supported nonbuilding structures that have rigid component dynamic characteristics, the R factor for the supporting structural system shall be used for the combined system. For supported nonbuilding structures that have flexible component dynamic characteristics, the R factor for the combined system shall not be greater than 3. The supported nonbuilding structure, and its supports and attachments, shall be designed for the forces determined from the analysis of the combined system.

14.2 GENERAL DESIGN REQUIREMENTS

14.2.1 Seismic Use Groups and importance factors. The Seismic Use Group and importance factor, I , for nonbuilding structures shall be determined based on the function of the structure and the relative hazard of its contents. The value of I shall be the largest of the values determined using approved standards, Table 14.2-1, and other provisions in this chapter.

Table 14.2-1 Seismic Use Groups and Importance Factors for Nonbuilding Structures

Seismic Use Group	I	II	III
Function ^a	F-I	F-II	F-III
Hazard ^b	H-I	H-II	H-III
Importance Factor	I = 1.0	I = 1.25	I = 1.5

^a Function shall be classified as follows:
 F-I Nonbuilding structures not classified as F-III.
 F-II Not applicable for nonbuilding structures.
 F-III Nonbuilding structures that are required for post-earthquake recovery or as emergency back-up facilities for Seismic Use Group III structures.

^b Hazard shall be classified as follows:
 H-I Nonbuilding structures that are not assigned to H-II or H-III.
 H-II Nonbuilding structures that have a substantial public hazard due to contents or use as determined by the authority having jurisdiction.
 H-III Nonbuilding structures containing sufficient quantities of toxic or explosive substance deemed to be hazardous to the public as determined by the authority having jurisdiction.

14.2.2 Ground motion. Where a site-specific study is required by an approved standard or the authority having jurisdiction, the design ground motion shall be determined in accordance with Sec. 3.4.

If a longer recurrence interval is defined in the adopted reference or other approved standard for a nonbuilding structure (such as LNG tanks), the recurrence interval required in the standard shall be used.

14.2.3 Design basis. Nonbuilding structures shall be designed to have sufficient stiffness, strength, and ductility to resist the effects of seismic ground motions. Where adopted references or other approved standards establish specific seismic design criteria for nonbuilding structures, the design shall satisfy those

criteria as amended in this chapter. When adopted references or other approved standards are not available, nonbuilding structures shall be designed in accordance with these *Provisions*.

Unless otherwise noted in this chapter, the effects on the nonbuilding structure due to gravity loads and seismic forces shall be combined in accordance with the factored load combinations as presented in ASCE 7 except that the seismic loads, E , shall be as defined in Sec. 4.2.2.1.

Where specifically required by these *Provisions*, the design seismic force on nonbuilding structure components sensitive to the effects of structural overstrength shall be as defined in Sec. 4.2.2.2. The system overstrength factor, Ω_o , shall be taken from Table 14.2-2.

14.2.4 Seismic-force-resisting system selection and limitations. The basic seismic-force-resisting system shall be selected as follows:

1. For nonbuilding structures similar to buildings, a system shall be selected from among the types indicated in Table 14.2-2 subject to the system limitations and height limits, based on Seismic Design Category, indicated in the table. The appropriate values of R , Ω_o , and C_d indicated in Table 14.2-2 shall be used in determining the base shear, element design forces, and design story drift as indicated in these *Provisions*. Design and detailing requirements shall comply with the sections referenced in table 14.2-2.
2. For nonbuilding structures not similar to buildings, a system shall be selected from among the types indicated in Table 14.2-3 subject to the system limitations and height limits, based on Seismic design Category indicated in the table. The appropriate values of R , Ω_o , and C_d indicated in Table 4.3-1 shall be used in determining the base shear, element design forces, and design story drift as indicated in these *Provisions*. Design and detailing requirements shall comply with the sections referenced in Table 14.2-3.
3. Where neither Table 14.2-2 nor Table 14.2-3 contains an appropriate entry, applicable strength and other design criteria shall be obtained from an adopted reference that is applicable to the specific type of nonbuilding structure. Design and detailing requirements shall comply with the adopted reference.

Where an approved standard provides a basis for the earthquake-resistant design of a particular type of nonbuilding structure, such a standard may be used subject to the following limitations:

1. The design ground motion shall be determined in accordance with Chapter 3.
2. The values for total lateral force and total base overturning moment used in design shall not be less than 80 percent of the base shear and overturning moment that would be obtained using Chapter 5 of these *Provisions*.
3. Where the approved standard defines acceptance criteria in terms of allowable stresses (as opposed to strengths), the design seismic forces shall be obtained from the *Provisions* and reduced by a factor of 1.4 for use with allowable stresses and allowable stress increases used in the approved standard are permitted.

Table 14.2-2 Design Coefficients and Factors for Nonbuilding Structures Similar to Buildings

Nonbuilding Structure Type	Required Detailing Provisions	R	Ω_0	C_d	System Limitations and Height Limits (ft) by Seismic Design Category ^a				
					B	C	D	E	F
Steel Storage Racks	Sec. 14.3.5	4	2	3.5	NL	NL	NL	NL	NL
Building frame systems:									
Special steel concentrically braced frames	AISC Seismic, Part I, Sec. 13	6	2	5	NL	NL	160	160	100
Ordinary steel concentrically braced frame									
With Building Structure Height Limits	AISC Seismic, Part I, Sec. 14	5	2	4.5	NL	NL	35 ^b	35 ^b	NP ^b
With Non-building Structure Height Limits	AISC Seismic, Part I, Sec. 14	3.5	2	3.5	NL	NL	160	160	100
Moment resisting frame systems:									
Special steel moment frames	AISC Seismic, Part I, Sec. 9	8	3	5.5	NL	NL	NL	NL	NL
Special reinforced concrete moment frames	Sec. 9.2.2.2 & ACI 318, Chapter 21	8	3	5.5	NL	NL	NL	NL	NL
Intermediate steel moment frames									
With Building Structure Height Limits	AISC Seismic, Part I, Sec. 10	4.5	3	4	NL	NL	35 ^{c,d}	NP ^{c,d}	NP ^{c,d}
With Non-building Structure Height Limits	AISC Seismic, Part I, Sec. 10	2.5	2	2.5	NL	NL	160	160	100
Intermediate reinforced concrete moment frames									
With Building Structure Height Limits	9.2.2.3 and ACI 318, Chapter 21	5	3	4.5	NL	NL	NP	NP	NP
With Non-building Structure Height Limits	9.2.2.3 and ACI 318, Chapter 21	3.5	2.5	3	NL	NL	50	50	50
Ordinary moment frames of steel									
With Building Structure Height Limits	AISC Seismic, Part I, Sec. 10	3.5	3	3	NL	NL	NP ^{c,d}	NP ^{c,d}	NP ^{c,d}
With Non-building Structure Height Limits	AISC Seismic, Part I, Sec. 10	2.5	2	2.5	NL	NL	100	100	NP ^c
Ordinary reinforced concrete moment frames	Sec. 9.3.1 & ACI 318, Chapter 21	3	3	2.5	NL	NP	NP	NP	NP

^a NL = no limit and NP = not permitted. If using metric units, 50 ft approximately equals 15 m. Heights are measured from the base of the structure as defined in Sec. 14 1.3.

^b Steel ordinary braced frames are permitted in pipe racks up to 65 feet (20 m).

^c Steel ordinary moment frames and intermediate moment frames are permitted in pipe racks up to a height of 65 feet (20 m) where the moment joints of field connections are constructed of bolted end plates.

^d Steel ordinary moment frames and intermediate moment frames are permitted in pipe racks up to a height of 35 ft (11 m).

Table 14.2-3 Design Coefficients and Factors for Nonbuilding Structures NOT Similar to Buildings

Nonbuilding Structure Type	Required Detailing Provisions	R	Ω_0	C_d	System Limitations and Height Limits (ft) by Seismic Design Category ^a				
					B	C	D	E	F
Elevated tanks, vessels, bins, or hoppers: On symmetrically braced legs On unbraced or asymmetrically braced legs Single pedestal or skirt supported - welded steel - prestressed or reinforced concrete ^c	Sec. 14.4.7.9	3	2 ^b	2.5	NL	NL	NL	160	100
		2	2 ^b	2.5	NL	NL	NL	100	60
		3	2 ^b	2	NL	NL	NL	NL	NL
		3 ^b	2 ^b	2	NL	NL	NL	NL	NL
Horizontal, saddle supported welded steel vessels	Sec. 14.4.7.13	3	2 ^b	2.5	NL	NL	NL	NL	NL
Tanks or vessels supported on structural towers similar to buildings	Sec. 14.3.2	3	2	2	NL	NL	NL	NL	NL
Flat bottom, ground supported tanks, or vessels: Steel or fiber-reinforced plastic: Mechanically anchored Self-anchored Reinforced or prestressed concrete: with reinforced nonsliding base with anchored flexible base with unanchored and unconstrained flexible base Other material	Sec. 14.4.7	3	2 ^b	2.5	NL	NL	NL	NL	NL
		2.5	2 ^b	2	NL	NL	NL	NL	NL
		2	2 ^b	2	NL	NL	NL	NL	NL
		3.25	2 ^b	2	NL	NL	NL	NL	NL
		1.5	1.5 ^b	1.5	NL	NL	NL	NL	NL
Cast-in-place concrete silos, stacks, and chimneys having walls continuous to the foundation	Sec. 14.4.3	3	1.75	3	NL	NL	NL	NL	NL
Reinforced masonry structures not similar to buildings	Chapter 11	3	2	2.5	NL	NL	NL	50	50
Plain masonry structures not similar to buildings	Chapter 11	1.25	2	1.5	NL	NL	50	50	50
Steel and reinforced concrete distributed mass cantilever structures not covered herein (including stacks, chimneys, silos, and skirt-supported vertical vessels that are not similar to buildings)	Adopted References	3	2	2.5	NL	NL	NL	NL	NL
Trussed towers (freestanding or guyed), guyed stacks and chimneys	Adopted References	3	2	2.5	NL	NL	NL	NL	NL
Cooling towers: Concrete or steel Wood frames	Adopted References	3.5	1.75	3	NL	NL	NL	NL	NL
		3.5	3	3	NL	NL	NL	50	50
Inverted pendulum type structures (except elevated tanks, vessels, bins and hoppers)	Adopted References	2	2	2	NL	NL	NL	NL	NL
Signs and billboards	Adopted References	3.5	1.75	3	NL	NL	NL	NL	NL
Self-supporting structures that are not similar to buildings and are not covered above or by approved standards	Adopted References	1.25	2	2.5	NL	NL	50	50	50

^a NL = no limit and NP = not permitted. If using metric units, 50 ft approximately equals 15 m. Heights are measured from the base of the structure as defined in Sec. 14.1.3.

^b In the case of tanks and vessels, the overstrength factors, Ω_0 , tabulated above apply only to connections, anchorages and other seismic-force-resisting tank *components* or *elements*, which shall be designed in accordance with the provisions of Sec. 14.4.7.2 and 14.4.7.4 (except that anchor bolts or anchor cables that are designed to yield shall be permitted to be designed using an overstrength value, $\Omega_0 = 1.0$). The overstrength provisions of Sec. 4.2.2.2 and the, Ω_0 , values tabulated above, do not apply to the design of walls, including interior walls of tanks and vessels.

^c Detailing in accordance with Sec. 9.2.1.6 of these *Provisions* for special reinforced concrete shear walls is required, or *R* shall be taken as 2.

14.2.5 Structural analysis procedure selection. Structural analysis procedures for nonbuilding structures that are similar to buildings shall be selected in accordance with Sec. 4.4.1 of these *Provisions*.

Nonbuilding structures that are not similar to buildings shall be analyzed by using either the equivalent lateral force procedure in accordance with Sec. 5.2 of these *Provisions*, the response spectrum procedure in accordance with Sec. 5.3 of these *Provisions*, or the procedure prescribed in the specific adopted reference.

14.2.6 Seismic weight. The seismic weight, W , for nonbuilding structures shall include all dead loads as defined for structures in Sec. 5.2.1. For the purposes of calculating design seismic forces in nonbuilding structures, W also shall include all normal operating contents for items such as tanks, vessels, bins, hoppers, and piping. W shall include snow and ice loads where these loads constitute 25 percent or more of W or where required by the authority having jurisdiction based on local environmental conditions.

14.2.7 Rigid nonbuilding structures. Nonbuilding structures that have a fundamental period, T , less than 0.06 sec, including their anchorages, shall be designed for the base shear, V , obtained using Eq. 14.2-1 as follows:

$$V = 0.3S_{DS}IW \quad (14.2-1)$$

where:

- S_{DS} = the short period spectral response acceleration parameter, as determined in Sec. 3.3.3,
- I = the importance factor, as determined from Table 14.2-1, and
- W = the seismic weight.

In this case, the force shall be distributed with height in accordance with Sec. 5.2.3.

14.2.8 Minimum base shear. For nonbuilding systems that have an R value provided in Table 14.2-2, the minimum value specified in Sec. 5.2.1.1 shall be replaced by:

$$C_s = 0.03 \quad (14.2-2)$$

and the minimum value specified in Eq. 5.2-5 shall be replaced by:

$$C_s = \frac{0.8S_1}{R/I} \quad (14.2-3)$$

Exceptions:

1. Nonbuilding systems that have an R value provided in Table 14.2-3 and are designed to an adopted reference as modified by these *Provisions* shall be subject to the minimum base shear values defined by Equations 5.2-4 and 5.2-5.
2. Minimum base shear requirements need not apply to the convective (sloshing) component of liquid in tanks.

14.2.9 Fundamental period. The fundamental period of the nonbuilding structure shall be determined using the structural properties and deformation characteristics of the resisting elements in a properly substantiated analysis, such as the method described in Sec. 5.3.2.

When adopted references or other approved standards are not available, the fundamental period T may be computed using the following formula:

$$T = 2\pi \sqrt{\frac{\sum_{i=1}^n w_i \delta_i^2}{g \sum_{i=1}^n f_i \delta_i}} \quad (14.2-4)$$

The values of f_i represent any lateral force distribution in accordance with the principles of structural mechanics. The elastic deflections, δ_i , shall be calculated using the applied lateral forces, f_i .

Equations 5.2-6, 5.2-7 and 5.2-8 shall not be used for determining the period of a nonbuilding structure.

14.2.10 Vertical distribution of seismic forces. In addition to the methods prescribed in Chapter 5 of these *Provisions*, it shall be permitted to determine the vertical distribution of lateral seismic forces in accordance with an adopted reference or other standard that is approved by the authority having jurisdiction and is applicable to the specific type of nonbuilding structure.

14.2.11 Deformation requirements. The drift limits of Sec. 4.5.1 need not apply to nonbuilding structures if a rational analysis indicates they can be exceeded without adversely affecting structural stability or attached or interconnected components and elements (such as walkways and piping). P-delta effects shall be considered where critical to the function or stability of the structure.

Structures shall satisfy the separation requirements as determined in accordance with Sec. 4.5.1 unless specifically amended in this chapter.

14.2.12 Nonbuilding structure classification. Nonbuilding structures with structural systems that are designed and constructed in a manner similar to buildings and that have dynamic response similar to building structures shall be classified as “similar to buildings” and shall be designed in accordance with Sec. 14.3. All other nonbuilding structures shall be classified as “not similar to buildings” and shall be designed in accordance with Sec. 14.4.

14.3 NONBUILDING STRUCTURES SIMILAR TO BUILDINGS

Nonbuilding structures similar to buildings, as defined in Sec. 14.1.3, shall be designed in accordance with these *Provisions* as modified by this section and the specific adopted references.

14.3.1 Electrical power generating facilities. Electrical power generating facilities are power plants that generate electricity by steam turbines, combustion turbines, diesel generators, or similar turbo machinery. Such structures shall be designed in accordance with Sec. 14.2 of these *Provisions*.

14.3.2 Structural towers for tanks and vessels. Structural towers that support tanks and vessels shall be designed in accordance with Sec. 14.1.5. In addition, the following special considerations shall be included:

1. The distribution of the lateral base shear from the tank or vessel onto the supporting structure shall consider the relative stiffness of the tank and resisting structural elements.
2. The distribution of the vertical reactions from the tank or vessel onto the supporting structure shall consider the relative stiffness of the tank and resisting structural elements. Where the tank or vessel is supported on grillage beams, the calculated vertical reaction due to weight and overturning shall be increased at least 20 percent to account for nonuniform support. The grillage beam and vessel attachment shall be designed for this increased design value.
3. Calculation of the seismic displacements of the tank or vessel shall consider the deformation of the support structure where determining P-delta effects or evaluating required clearances to prevent pounding of the tank on the structure.

14.3.3 Piers and wharves. Piers and wharves are structures located in waterfront areas that project into a body of water. Two categories of these structures are:

- a. Piers and wharves with general public occupancy, such as cruise ship terminals, retail or commercial offices, restaurants, fishing piers and other tourist attractions.
- b. Piers and wharves where occupancy by the general public is not a consideration and economic considerations (on a regional basis, or for the owner) are a major design consideration, such as container wharves, marine oil terminals, bulk terminals, etc., or other structures whose primary function is to moor vessels and barges.

These structures shall conform to the building or building-like structural requirements of the Provisions or other rational criteria and methods of design and analysis. Any methods used for design of these structures should recognize the unique importance of liquefaction and soil failure collapse mechanisms, as well as consider all applicable marine loading combinations, such as mooring, berthing, wave and current. Structural detailing shall be carefully considered for the marine environment.

14.3.3.1 Additional seismic mass. Seismic forces on elements below the water level shall include the inertial force of the mass of the displaced water. The additional seismic mass equal to the mass of the displaced water shall be included as a lumped mass on the submerged element, and shall be added to the calculated seismic forces of the pier or wharf structure.

14.3.3.2 Soil effects. Seismic dynamic forces from the soil shall be determined by the registered design professional. The design shall account for the effects of liquefaction on piers and wharves, as appropriate.

14.3.4 Pipe racks. Pipe racks supported at the base shall be designed for the forces defined in Chapter 5 of these *Provisions*.

Displacements of the pipe rack shall be calculated using Eq. 5.2-15. The potential for interaction effects (pounding of the piping system) shall be considered based on these amplified displacements.

Piping systems, and their supports and attachments, shall be designed in accordance with Sec. 6.4.7. Friction resulting from gravity loads shall not be considered to provide resistance to seismic forces.

14.3.5 Steel storage racks. Steel storage racks supported below, at, or above grade shall be designed in accordance with this section.

14.3.5.1 Testing. Unless higher values of R are justified by test data, the seismic-force-resisting system shall be subject to the requirements and limitations of Sec. 14.2.4.

14.3.5.2 Importance factor. For storage racks in occupancies open to the general public, the importance factor, I , shall be taken as 1.5.

14.3.5.3 Operating weight. Steel storage racks shall be designed for each of the following conditions of operating weight, W .

1. Weight of the rack plus every storage level loaded to 67 percent of its rated load capacity.
2. Weight of the rack plus the highest storage level only loaded to 100 percent of its rated load capacity.

The design shall consider the actual height of the center of mass of each storage load component.

14.3.5.4 Vertical distribution of seismic forces. For all steel storage racks, the vertical distribution of seismic forces shall be as specified in Sec. 5.2.3 and in accordance with the following:

1. The base shear, V , of the steel storage rack shall be determined considering the loading conditions defined in Sec. 14.3.5.3.
2. The base of the structure shall be the floor supporting the steel storage rack. Each storage level of the rack shall be treated as a level of the structure, with heights h_i and h_x measured from the base of the structure.

3. The factor k may be taken as 1.0.

14.3.5.5 Seismic displacements. Steel storage rack installations shall accommodate the seismic displacement of the storage racks and their contents relative to all adjacent or attached components and elements. The assumed total relative displacement for storage racks shall not be less than 5 percent of the height above the base unless a smaller value is justified by test data or a properly substantiated analysis.

14.3.5.6 RMI storage racks. Steel storage racks designed in accordance with Sec. 2.7 of RMI shall be deemed to satisfy the seismic force and displacement requirements of these *Provisions* if all of the following conditions are met:

1. Where determining the value of C_a in Sec. 2.7.3 of RMI, the value of C_s is taken as equal to $S_{DS}/2.5$, the value of C_v is taken as equal to S_{DI} , and the value of I_p is taken equal to the importance factor, I , determined in accordance with Sec. 14.3.5.2;
2. The value of C_s in RMI is not taken less than $0.14S_{DS}$; and
3. For storage racks supported above grade, the value of C_s in RMI is not taken less than the value determined for F_p in accordance with Sec. 6.2.6 of these *Provisions* where R_p taken equal to R , a_p taken equal to 2.5, and I_p is taken equal to the importance factor, I , determined in accordance with Sec. 14.3.5.2.

14.4 NONBUILDING STRUCTURES NOT SIMILAR TO BUILDINGS

The following nonbuilding structures usually do not have lateral and vertical seismic-force-resisting-systems that are similar to buildings and shall be designed in accordance with these *Provisions* as modified by this section and the specific references.

14.4.1 General

14.4.1.1 Loads. Loads and load distributions that are less severe than those determined in accordance with these *Provisions* shall not be used.

14.4.1.2 Redundancy. The redundancy factor, ρ , shall be permitted to be taken as 1.

14.4.2 Earth retaining structures. This section applies to all earth retaining walls. The applied seismic forces shall be based on the recommendations in a geotechnical report prepared by a registered design professional in accordance with Sec. 7.5.1.

14.4.3 Stacks and chimneys. Stacks and chimneys are permitted to be either lined or unlined, and shall be constructed of concrete, steel, or masonry.

Steel stacks, concrete stacks, steel chimneys, concrete chimneys, and liners shall be designed to resist seismic lateral forces determined from a substantiated analysis using approved standards. Interaction of the stack or chimney with the liners shall be considered. A minimum separation shall be provided between the liner and chimney equal to C_d times the calculated differential lateral drift.

14.4.4 Amusement structures. Amusement structures are permanently fixed structures constructed primarily for the conveyance and entertainment of people. Such structures shall be designed to resist seismic lateral forces determined from a substantiated analysis using approved standards.

14.4.5 Special hydraulic structures. Special hydraulic structures are structures that are within liquid-containing structures and are exposed to liquids on both wall surfaces at the same head elevation under normal operating conditions. Under earthquake excitation, such structures are subjected to out-of-plane forces which arise due to differential hydrodynamic pressures. Special hydraulic structures include separation walls, baffle walls, weirs, and other similar structures.

Special hydraulic structures shall be designed for out-of-phase movement of the fluid. Unbalanced forces from the motion of the liquid must be applied simultaneously “in front of” and “behind” these elements.

Structures subject to hydrodynamic pressures induced by earthquakes shall be designed for rigid body and sloshing liquid forces and their own inertia force. The height of sloshing shall be determined and compared to the freeboard height of the structure.

Interior elements, such as baffles or roof supports, also shall be designed for the effects of unbalanced forces and sloshing.

14.4.6 Secondary containment systems. Secondary containment systems, such as impoundment dikes and walls, shall meet the requirements of the applicable standards for tanks and vessels and any additional requirements imposed by the authority having jurisdiction.

Secondary containment systems shall be designed to withstand the effects of a maximum considered earthquake when empty and a maximum considered earthquake when full, including all hydrodynamic forces.

Sloshing of the liquid within the secondary containment area shall be considered in determining the height of the impound. The freeboard provided shall not be less than the sloshing height, δ_s , determined using Eq. 14.4-9. For circular impoundment dikes, D shall be the diameter of the impoundment. For rectangular impoundment dikes, D shall be the longer horizontal plan dimension.

14.4.7 Tanks and vessels. This section applies to all tanks, vessels, bins, silos, and similar containers storing liquids, gases, or granular solids supported at the base (hereinafter referred to as “tanks and vessels”). Tanks and vessels covered herein include those constructed of reinforced concrete, prestressed concrete, steel, and fiber-reinforced plastic materials. The supports and attachments for tanks supported on elevated levels in buildings shall be designed in accordance with Chapter 6.

14.4.7.1 Design basis. Tanks and vessels storing liquids, gases, or granular solids shall satisfy the analysis and design requirements set forth in the applicable references as indicated in Table 14.1-1 and the additional requirements of these *Provisions* including the following:

1. Damping for the convective (sloshing) force component shall be taken as 0.5 percent unless otherwise define in an adopted reference or other approved standard.
2. Impulsive and convective components may be combined by taking the square root of the sum of the squares of the components.
3. Vertical earthquake effects shall be considered in accordance with the applicable approved standard. If the approved standard permits the user the option of including or excluding the vertical earthquake effects, to comply with these *Provisions*, they shall be included. For tanks and vessels not covered by an approved standard, the forces due to the vertical acceleration shall be defined as follows:
 - a. Hydrodynamic *vertical and lateral* forces in tank walls: The increase in hydrostatic pressures due to the vertical excitation of the contained liquid shall correspond to an effective increase in density, γ_L , of the stored liquid equal to $0.2S_{DS} \gamma_L$.
 - b. Hydrodynamic *hoop* forces in cylindrical tank walls: In a cylindrical tank wall, the *hoop* force per unit height, N_h , at level y from the base, associated with the vertical excitation of the contained liquid, shall be computed in accordance with Eq. 14.4-1

$$N_h = 0.2S_{DS}\gamma_L(H_L - y)(D_i/2) \quad (14.4-1)$$

where:

D_i = inside tank diameter (ft)

H_L = liquid height inside the tank (ft).

y = distance from base of the tank to level being investigated (ft).

$$\gamma_L = \text{unit weight of stored liquid (lb/ft}^3\text{)}$$

- c. Vertical *inertia* forces in cylindrical and rectangular tank walls: Vertical *inertia* forces associated with the vertical acceleration of the structure itself shall be taken equal to $0.2S_{DS}W$.

14.4.7.2 Strength and ductility. Structural components and members that are part of the lateral support system shall be designed to provide the following:

1. Connections and attachments for anchorage and other seismic-force-resisting components shall be designed to develop the lesser of the yield strength of the anchor or Ω_0 times the calculated element design load.
2. Penetrations, manholes, and openings in shell components shall be designed to maintain the strength and stability of the shell to carry tensile and compressive membrane shell forces.
3. Support towers for tanks and vessels with irregular bracing, unbraced panels, asymmetric bracing, or concentrated masses shall be designed using the provisions of Sec. 4.3.2 for irregular structures. Support towers using chevron or eccentric braced framing shall satisfy the appropriate requirements of these *Provisions*. Support towers using tension only bracing shall be designed such that the full cross section of the tension element can yield during overload conditions.
4. Compression struts that resist the reaction forces from tension braces shall be designed to resist the lesser of the yield strength of the brace (A_gF_y), or Ω_0 times the calculated tension load in the brace.
5. The vessel stiffness relative to the support system (foundation, support tower, skirt, etc.) shall be considered in determining forces in the vessel, the resisting components, and the connections.
6. For concrete liquid-containing structures, system ductility and energy dissipation under unfactored loads shall not be allowed to be achieved by inelastic deformations to such a degree as to jeopardize the serviceability of the structure. Stiffness degradation and energy dissipation shall be allowed to be obtained either through limited microcracking, or by means of lateral-force resistance mechanisms that dissipate energy without damaging the structure.

14.4.7.3 Flexibility of piping attachments. Design of piping systems connected to tanks and vessels shall consider the potential movement of the connection points during earthquakes and provide sufficient flexibility to avoid release of the product by failure of the piping system. The piping system and supports shall be designed so as not to impart significant mechanical loading on the attachment to the tank or vessel shell. Local loads at piping connections shall be considered in the design of the tank or vessel shell. Mechanical devices which add flexibility, such as bellows, expansion joints, and other flexible apparatus, may be used where they are designed for seismic displacements and defined operating pressure.

Unless otherwise calculated, the minimum displacements in Table 14.4-1 shall be assumed. For attachment points located above the support or foundation elevation, the displacements in Table 14.4-1 shall be increased to account for drift of the tank or vessel.

Table 14.4-1 Minimum Design Displacements for Piping Attachments

Condition	Displacement (in.)
Mechanically-anchored tanks and vessels:	
Upward vertical displacement relative to support or foundation	1
Downward vertical displacement relative to support or foundation	0.5
Range of displacement (radial and tangential) relative to support or foundation:	0.5
Self-anchored tanks and vessels (at grade):	
Upward vertical displacement relative to support or foundation	

If designed in accordance with an adopted reference.	1
Anchorage ratio less than or equal to 0.785 (indicates no uplift):	4
Anchorage ratio greater than 0.785 (indicates uplift):	
If designed for seismic loads in accordance with these <i>Provisions</i> but not covered by an adopted reference:	8
For tanks and vessels with a diameter less than 40 ft:	12
For tanks and vessels with a diameter equal to or greater than 40 ft:	
Downward vertical displacement relative to support of foundation	0.5
For tanks with a ringwall/mat foundation:	1
For tanks with a berm foundation:	2
Range of horizontal displacement (radial and tangential) relative to support or foundation	

The anchorage ratio, J, for self-anchored tanks is defined as:

$$J = \frac{M_{rw}}{D^2(w_t + w_a)} \tag{14.4-2}$$

Where:

$$w_t = \frac{W_s}{\pi D} + w_{rs}$$

w_{rs} = roof load acting on the shell in pounds per foot. Only permanent roof loads shall be included. Roof live load shall not be included.

w_a = weight of annular plate participating

M_{rw} = the ringwall overturning moment due to the seismic design loads

D = tank diameter

Anchorage Ratio

J anchorage ratio	Criteria
J < 0.785	No uplift under the design seismic overturning moment. The tank is self anchored.
0.785 < J < 1.54	Tank is uplifting, but the tank is stable for the design load providing the shell compression requirements are satisfied. Tank is self-anchored.
J > 1.54	Tank is not stable and cannot be self-anchored for the design load. Modify annular plate if $L < 0.035D$ is not controlling or add mechanical anchors.

Where the elastic deformations are calculated, the minimum design displacements for piping attachments shall be the calculated displacements at the point of attachment increased by the amplification factor C_d .

The values given in Table 14.4-1 do not include the influence of relative movements of the foundation and piping anchorage points due to foundation movements (such as settlement or seismic displacements). The effects of foundation movements shall be included in the design of the piping

system design, including the determination of the mechanical loading on the tank or vessel consideration of the total displacement capacity of the mechanical devices intended to add flexibility.

14.4.7.4 Anchorage. Tanks and vessels at grade are permitted to be designed without anchorage where they meet the requirements for unanchored tanks in approved standards. Tanks and vessels supported above grade on structural towers or building structures shall be anchored to the supporting structure.

The following special detailing requirements shall apply to steel tank anchor bolts in seismic regions where S_{DS} is greater than 0.5, or where the structure is assigned to Seismic Use Group III.

1. Hooked anchor bolts (L- or J-shaped embedded bolts) or other anchorage systems based solely on bond or mechanical friction shall not be used where S_{DS} is greater than 0.33. Post-installed anchors may be used provided that testing validates their ability to develop the yield load in the anchor when subjected to cyclic loads in cracked concrete.
2. Where anchorage is required, the anchor embedment into the foundation shall be designed to develop the minimum specified yield strength of the anchor.

14.4.7.5 Ground-supported storage tanks for liquids

14.4.7.5.1 Seismic forces. Ground-supported, flat bottom tanks storing liquids shall be designed to resist the seismic forces calculated using one of the following procedures:

1. The base shear and overturning moment calculated in accordance with Sec. 14.2.7 of these *Provisions* assuming the tank and all its contents are a rigid mass system.
2. Tanks or vessels assigned to Seismic Use Group III or with a diameter greater than 20 ft shall be designed considering the hydrodynamic pressures of the liquid in determining the equivalent lateral forces and lateral force distribution in accordance with the appropriate references listed in Table 14.1-1 and Sec. 14.4.7 of these *Provisions*.
3. The force and displacement provisions of Sec 5.2 of these *Provisions*.

The design of tanks storing liquids shall consider the impulsive and convective (sloshing) effects and consequences on the tank, foundation, and attached elements. The impulsive component corresponds to the high frequency amplified response to the lateral ground motion of the tank roof, shell, and portion of the contents that moves in unison with the shell. The convective component corresponds to the low frequency amplified response of the contents in the fundamental sloshing mode. The following definitions shall apply:

T_c = natural period of the first (convective) mode of sloshing,

T_i = fundamental period of the tank structure and impulsive component of the contents,

T_v = natural period of vertical vibration of the liquid and tank structural system,

V_i = base shear due to impulsive component from the weight of tank and its contents,

V_c = base shear due to the convective component of the effective sloshing mass,

W_i = impulsive weight (impulsive component of liquid, roof and equipment, shell, bottom and internal components).

W_c = the portion of the liquid weight sloshing.

The seismic base shear is the combination of the impulsive and convective components:

$$V = \sqrt{V_i^2 + V_c^2} \quad (14.4-3)$$

where:

$$V_i = \frac{S_{ai}}{R} W_i \quad (14.4-4)$$

$$V_c = \frac{S_{ac}}{R_c} W_c \quad (14.4-5)$$

where

R_c = the force reduction factor for the convective force = 1.5

S_{ai} = the spectral acceleration, in terms of the acceleration due to gravity, including the site impulsive components at period T_i and assuming 5 percent damping.

$$\text{For } T_i \leq T_s, S_{ai} = S_{DS}. \quad (14.4-6)$$

$$\text{For } T_i > T_s, S_{ai} = \frac{S_{DI}}{T_i} \quad (14.4-7)$$

Note: Where an adopted reference or other approved standard is used in which the spectral acceleration for the tank shell and the impulsive component of the liquid is independent of T_i , S_{ai} shall be taken equal to S_{DS} , for all cases.

S_{ac} = the spectral acceleration of the sloshing liquid based on the sloshing period T_c and assuming 0.5 percent damping.

$$\text{For } T_c \leq 4.0 \text{ sec, } S_{ac} = \frac{1.5S_{DI}}{T_c} \leq S_{DS} \quad (14.4-8)$$

$$\text{For } T_c > 4.0 \text{ sec, } S_{ac} = \frac{6S_{DI}}{T_c^2} \quad (14.4-9)$$

The natural period of the first (convective) mode of sloshing shall be determined using Eq. 14.4-10 as follows:

$$T_c = 2\pi \sqrt{\frac{D}{3.68g \tanh\left(\frac{3.68H}{D}\right)}} \quad (14.4-10)$$

where D = the tank diameter, H = liquid height, and g = the acceleration due to gravity.

The general design response spectra for ground-supported liquid storage tanks is shown in Figure 14.4-1.

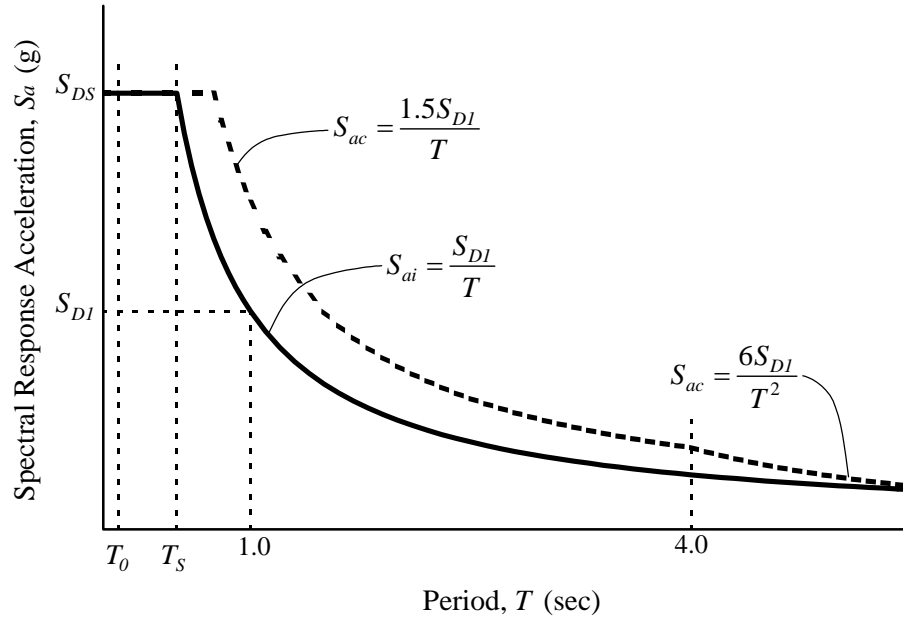

Figure 14.4-1 Design Response Spectra for Ground-supported Liquid Storage Tanks

14.4.7.5.2 Distribution of hydrodynamic and inertia forces. Unless otherwise required by the appropriate reference in Table 14.1-1, the method given ACI 350.3 may be used to determine the vertical and horizontal distribution of the hydrodynamic and inertia forces on the walls of circular and rectangular tanks.

14.4.7.5.3 Freeboard. Sloshing of the stored liquid shall be taken into account in the seismic design of tanks and vessels in accordance with the following provisions:

1. The *height of the sloshing wave*, δ_s , shall be computed using Eq. 14.4-11 as follows:

$$\delta_s = 0.5D_iIS_{ac} \quad (14.4-11)$$

For cylindrical tanks, D_i shall be the inside diameter of the tank; for rectangular tanks, the term D_i shall be replaced by the longer longitudinal plan dimension of the tank, L .

2. The *effects of sloshing* shall be accommodated by means of one of the following:
 - A minimum freeboard in accordance with Table 14.4-2.
 - A roof and supporting structure designed to contain the sloshing liquid in accordance with subsection 3 below.
 - For open-top tanks or vessels only, an overflow spillway around the tank or vessel perimeter.
3. If sloshing is restricted because the freeboard provided is less than the computed sloshing height, the roof in the vicinity of the roof-to-wall joint shall be permitted to be designed for an equivalent *hydrostatic* head equal to the computed sloshing height less the freeboard provided. In addition, the design of the tank shall take into account the fact that a portion of the confined convective (sloshing) mass becomes part of the impulsive mass in proportion to the degree of confinement.

Table 14.4-2 Minimum Required Freeboard^a

Value of S_{DS}	Seismic Use Group		
	I	II	III
$S_{DS} < 0.167$	— ^b	— ^b	δ_s
$0.167 \leq S_{DS} < 0.33$	— ^b	— ^b	δ_s
$0.33 \leq S_{DS} < 0.50$	— ^b	$0.7\delta_s$	δ_s
$0.50 \leq S_{DS}$	— ^b	$0.7\delta_s$	δ_s

^a The noted freeboard is required unless one of the following conditions is satisfied:

1. Secondary containment in accordance with Sec. 14.4.6 is provided to control the product spill.
2. The roof and supporting structure are designed to contain the sloshing liquid.

^b No minimum freeboard is required.

14.4.7.5.4 Equipment and attached piping. Equipment, piping, and walkways or other appurtenances attached to the structure shall be designed to accommodate the displacements imposed by seismic forces. For piping attachments, see Sec. 14.4.7.3.

14.4.7.5.5 Internal components. The attachments of internal equipment and accessories that are attached to the primary liquid or pressure retaining shell or bottom, or provide structural support for major components (such as a column supporting the roof rafters) shall be designed for the lateral loads due to the sloshing liquid in addition to the inertial forces.

14.4.7.5.6 Sliding resistance. The transfer of the total lateral shear force between the tank or vessel and the subgrade shall be considered as follows:

1. For unanchored, flat-bottom steel tanks, the overall horizontal seismic shear force shall be resisted by friction between the tank bottom and the foundation or subgrade. Unanchored storage tanks must be designed such that sliding will not occur when the tank is full of stored product. The maximum calculated seismic base shear, V , shall not exceed $N \tan(30^\circ)$.

N shall be determined using the effective weight of the tank, roof, and contents, after reduction for vertical earthquake effects. Values of the friction factor lower than $\tan(30^\circ)$ should be used if the condition at the bottom of the tank (such as a leak detection membrane beneath the bottom with a lower friction factor, smooth bottoms, etc.) is not consistent with such a friction value.

2. No additional lateral anchorage is required for anchored steel tanks designed in accordance with approved standards.
3. The lateral shear transfer behavior for special tank configurations (such as shovel bottoms, highly crowned tank bottoms, or tanks on grillage) can be unique and is beyond the scope of these *Provisions*.

14.4.7.5.7 Local shear transfer. Local transfer of the shear from the roof to the wall and for the wall of the tank into the base shall be considered. For cylindrical tanks and vessels, the peak local tangential shear per unit length shall be calculated using Eq. 14.4-12 as follows:

$$V_{max} = \frac{2V}{\pi D} \quad (14.4-12)$$

Shear transfer shall be accomplished as follows:

1. Tangential shear in flat-bottom steel tanks shall be transferred through the welded connection to the steel bottom. This transfer mechanism is deemed acceptable where S_{as} is less than 1.0 and the tank is designed in accordance with the approved standards.

2. For concrete tanks with a sliding base where the lateral shear is resisted by friction between the tank wall and the base, the friction coefficient shall not exceed $\tan(30 \text{ degrees})$.
3. In fixed-base or hinged-base concrete tanks, the total horizontal seismic base shear is transferred to the foundation by a combination of membrane (tangential) shear and radial shear. For anchored flexible-base concrete tanks, the majority of the base shear is resisted by membrane (tangential) shear through the anchoring system with only insignificant vertical bending in the wall. The connection between the wall and floor shall be designed to resist the maximum tangential shear.

14.4.7.5.8 Pressure stability. For steel tanks, the internal pressure from the stored product stiffens thin cylindrical shell structural elements subjected to membrane compression forces. This stiffening effect may be considered in resisting seismically induced compressive forces if permitted by the approved standard or the authority having jurisdiction.

14.4.7.5.9 Shell support. Steel tanks resting on concrete ring walls or slabs shall have a uniformly supported annulus under the shell. Uniform support shall be provided by one of the following methods:

1. Shimming and grouting the annulus,
2. Using fiberboard or other suitable padding,
3. Using butt-welded bottom or annular plates resting directly on the foundation, or
4. Using closely spaced shims (without structural grout) provided that the localized bearing loads are considered in the design of the tank wall and foundation so as to prevent local crippling and spalling.

Anchored tanks shall be shimmed and grouted. Local buckling of the steel shell for the peak compressive force due to operating loads and seismic overturning shall be considered.

14.4.7.5.10 Repair, alteration, or reconstruction. Repairs, modifications, or reconstruction (such as cut-down and re-erection) of a tank or vessel shall comply with industry standard practice and these *Provisions*. For welded steel tanks storing liquids, see API 653 and the adopted reference in Table 14.1-1. Tanks that are relocated shall be re-evaluated for the seismic loads for the new site and the requirements of new construction in accordance with the appropriate approved standard and these *Provisions*.

14.4.7.6 Water and water treatment tanks and vessels

14.4.7.6.1 Welded steel. Welded steel water storage tanks and vessels shall be designed in accordance with the seismic requirements of AWWA D100 except that the sloshing height shall be calculated in accordance with Sec 14.4.7.5.3 (rather than using Eq. 13-26 of AWWA D100) and design input forces shall be modified as follows:

1. The impulsive and convective components of the base shear for allowable stress design procedures shall be determined using the following equations, which shall be substituted into Eq. 13-4 and 13-8 of AWWA D100:

$$\text{For } T_s < T_c < 4.0 \text{ sec, } V_i = \frac{S_{DS}I}{1.4R} W_i \quad \text{and} \quad V_c = \frac{S_{DS}I}{1.4RT_c}$$

$$\text{For } T_c \geq 4.0 \text{ sec, } V_c = \frac{6S_{DS}I}{1.4R} \frac{T_s}{T_c^2} W_c$$

2. In Eq. 13-4, 13-8, and 13-20 through 13-25 of AWWA D100, the following changes shall be made:

$$\frac{ZI}{R_w} \text{ shall be replaced by } \frac{S_{DS}I}{2.5(1.4R)}, \text{ and}$$

the term S shall be replaced by the term B .

Where S_{DS} and T_s are determined in accordance with Chapter 3, R is determined in accordance with Sec. 14.2.4, and B is determined as follows:

$$\text{For } T_s < T_c < 4.0 \text{ sec, } B = 1.11T_s$$

$$\text{For } T_c \geq 4.0 \text{ sec, } B = 1.25T_s$$

Thus, Eq. 13-4 of AWWA D100, for base shear at the bottom of the tank shell, becomes

$$V_{ACT} = \frac{18S_{DS}I}{2.5(1.4R)} \left[0.14(W_s + W_r + W_f + W_l) + BC_l W_2 \right]$$

Alternatively,

$$\text{For } T_s < T_c < 4.0 \text{ sec, } V_{ACT} = \frac{S_{DS}I}{1.4R} \left[(W_s + W_r + W_f + W_l) + 1.5 \frac{T_s}{T_c} W_2 \right]$$

$$\text{For } T_s \geq 4.0 \text{ sec, } V_{ACT} = \frac{S_{DS}I}{1.4R} \left[(W_s + W_r + W_f + W_l) + 6 \frac{T_s}{T_c^2} W_2 \right]$$

Similarly, Eq. 13-8 of AWWA D100, for overturning moment applied to the bottom of the tank shell, becomes

$$M = \frac{18S_{DS}I}{2.5(1.4R)} \left[0.14(W_s X_s + W_r H_t + W_l X_l) + BC_l W_2 X_2 \right]$$

14.4.7.6.2 Bolted steel. Bolted steel water storage structures shall be designed in accordance with the seismic requirements of AWWA D103 except that the design input forces shall be modified in the same manner as shown in Sec 14.4.7.6.1 of these *Provisions*.

14.4.7.6.3 Reinforced and prestressed concrete. Reinforced and prestressed concrete tanks shall be designed in accordance with the seismic requirements of ACI 350.3 except that the design input forces shall be modified as follows:

1. For $T_i < T_o$ or $T_i > T_s$, the following terms shall be replaced by $\frac{S_a I}{1.4R}$:

For shear and overturning moment equations of AWWA D110 and AWWA D115, $\frac{ZIC_l}{R_l}$, and

For base shear and overturning moment equations of ACI 350.3, $\frac{ZISC_l}{R_i}$.

2. For $T_o \leq T_i \leq T_s$, $\frac{ZIC_i}{R_l}$ and $\frac{ZISC_i}{R_i}$ shall be replaced by $\frac{S_{DS}I}{1.4R}$.

3. For all values of T_c (or T_w), $\frac{ZIC_c}{R_c}$ and $\frac{ZISC_c}{R_c}$ shall be replaced by $\frac{6S_{DI}I}{T_c^2}$ or $\frac{6S_{DS}I}{T_c^2} T_s$.

Thus, for $T_o \leq T_i \leq T_s$,

$$\text{Eq. 4-1 of AWWA D110 becomes } V_l = \frac{S_{DS}I}{1.4R} (W_s + W_R + W_l), \text{ and}$$

$$\text{Eq. 4-2 of AWWA D110 becomes } V_c = \frac{6S_{DS}I}{1.4R} \left(\frac{T_s}{T_c^2} \right) W_c.$$

Where S_a , S_{DI} , S_{DS} , T_o , and T_s are determined in accordance with Chapter 3 of these *Provisions*.

14.4.7.7 Petrochemical and industrial tanks and vessels storing liquids

14.4.7.7.1 Welded steel. Welded steel petrochemical and industrial tanks and vessels storing liquids shall be designed in accordance with the seismic requirements of API 650 and API 620 except that the design input forces shall be modified as indicated in this section.

Where using the equations in Sec. E.3 of API 650, the following substitutions shall be made in the equation for overturning moment M :

For $T_o < T_i \leq T_s$ 4.0 sec, $M = S_{DS}I \left[0.24(W_s X_s + W_t H_t + W_l X_l) + 0.80C_2 T_s W_2 X_2 \right]$, and

$$C_2 = \frac{0.75S}{T_c} \text{ and } S = 1.0$$

For $T_c > 4.0$ sec, $M = S_{DS}I \left[0.24(W_s X_s + W_t H_t + W_l X_l) + 0.71C_2 T_s W_2 X_2 \right]$, and

$$C_2 = \frac{3.375S}{T_c^2} \text{ and } S = 1.0.$$

Where S_{DS} and T_s are determined in accordance with Chapter 3 of these Provisions.

14.4.7.7.2 Bolted steel. Bolted steel tanks used for storage of production liquids are designed in accordance with API 12B, which covers the material, design, and erection requirements for vertical, cylindrical, above-ground, bolted tanks in nominal capacities of 100 to 10,000 barrels for production service. Unless required by the authority having jurisdiction, these temporary structures need not be designed for seismic loads. If design for seismic load is required, the loads may be adjusted for the temporary nature of the anticipated service life.

14.4.7.7.3 Reinforced and prestressed concrete. Reinforced concrete tanks for the storage of petrochemical and industrial liquids shall be designed in accordance with the force requirements of Sec. 14.4.7.6.3.

14.4.7.8 Ground-supported storage tanks for granular materials

14.4.7.8.1 Design considerations. In determining the effective mass and load paths, consideration shall be given to the intergranular behavior of the material as follows:

1. Increased lateral pressure (and the resulting hoop stress) due to loss of the intergranular friction of the material during the seismic shaking,
2. Increased hoop stresses resulting from temperature changes in the shell after the material has been compacted, and
3. Intergranular friction that can transfer seismic shear directly to the foundation.

14.4.7.8.2 Lateral force determination. The lateral forces for tanks and vessels storing granular materials at grade shall be determined using the requirements and accelerations for short period structures.

14.4.7.8.3 Force distribution to shell and foundation

14.4.7.8.3.1 Increased lateral pressure. The increase in lateral pressure on the tank wall shall be added to the static design lateral pressure but shall not be used in the determination of pressure stability effects on the axial buckling strength of the tank shell.

14.4.7.8.3.2 Effective mass. A portion of a stored granular mass will act with the shell (the effective mass). The effective mass is related to the physical characteristics of the product, the height-to-diameter (H/D) ratio of the tank and the intensity of the seismic event. The effective mass shall be used to determine the shear and overturning loads resisted by the tank.

14.4.7.8.3.3 Effective density. The effective density factor (that part of the total stored mass of product that is accelerated by the seismic event) shall be determined in accordance ACI 313.

14.4.7.8.3.4 Lateral sliding. For granular storage tanks that have a steel bottom and are supported such that friction at the bottom to foundation interface can resist lateral shear loads, no additional anchorage to prevent sliding is required. For tanks without steel bottoms (that is, where the material rests directly on the foundation), shear anchorage shall be provided to prevent sliding.

14.4.7.8.3.5 Combined anchorage systems. If separate anchorage systems are used to prevent overturning and sliding, the relative stiffness of the systems shall be considered in determining the load distribution.

14.4.7.8.4 Welded steel. Welded steel granular storage structures shall be designed for seismic forces determined in accordance with these *Provisions*. Component allowable stresses and materials shall be in accordance with AWWA D100, except that the allowable circumferential membrane stresses and material requirements in API 650 shall apply.

14.4.7.8.5 Bolted steel. Bolted steel granular storage structures shall be designed for seismic forces determined in accordance with these *Provisions*. Component allowable stresses and materials shall be in accordance with AWWA D103.

14.4.7.8.6 Reinforced and prestressed concrete. Reinforced and prestressed concrete structures for the storage of granular materials shall be designed for seismic forces determined in accordance with these *Provisions* and shall satisfy the requirements of ACI 313.

14.4.7.9 Elevated tanks and vessels for liquids and granular materials. This section applies to tanks, vessels, bins, and hoppers that are elevated above grade where the supporting tower is an integral part of the structure, or where the primary function of the tower is to support the tank or vessel. Tanks and vessels that are supported within buildings or are incidental to the primary function of the tower are considered mechanical equipment and shall be designed in accordance with Chapter 6 of these *Provisions*.

Elevated tanks shall be designed to satisfy the force and displacement requirements of the applicable approved standard, or these *Provisions*.

14.4.7.9.1 Effective mass. The design of the supporting tower or pedestal, anchorage, and foundation for seismic overturning shall assume the material stored is a rigid mass acting at the volumetric center of gravity. The effects of fluid-structure interaction may be considered in determining the forces, effective period, and mass centroids of the system if the following requirements are met:

1. The sloshing period, T_c is greater than $3T$ where T is the natural period of the tank (with the contents assumed to be rigid) and supporting structure.
2. The sloshing mechanism (percentage of convective mass and centroid) is determined for the specific configuration of the container by detailed fluid-structure interaction analysis or testing.
3. Soil-structure interaction in accordance with Sec. 5.6 may be included in determining T .

14.4.7.9.2 P-delta effects. The lateral drift of the elevated tank shall be considered as follows:

1. For evaluating the additional load in the support structure due to P-delta effects, the design drift shall be computed as the elastic lateral displacement at the center of gravity of the stored mass times the deflection amplification factor, C_d .
2. The base of the tank shall be assumed to be fixed rotationally and laterally.
3. Deflections due to bending, axial tension, or compression shall be considered. For pedestal tanks with a height-to-diameter ratio less than 5, shear deformations of the pedestal shall be considered.
4. The dead load effects of roof-mounted equipment or platforms shall be included in the analysis.

5. If constructed within the plumbness tolerances specified in the approved standard, initial tilt need not be considered in the P-delta analysis.

14.4.7.9.3 Transfer of lateral forces into support tower. For post-supported tanks and vessels that are cross-braced:

1. The bracing shall be installed in such a manner as to provide uniform resistance to the lateral load (such as pre-tensioning or tuning to attain equal sag).
2. The additional load in the brace due to the eccentricity between the post-to-tank attachment and the line of action of the bracing shall be included.
3. Eccentricity of compression strut lines of action with their attachment points shall be considered.
4. The connection of the post or leg with the foundation shall be designed to resist both the vertical and lateral resultant from the yield load in the bracing assuming the direction of the lateral load is oriented to produce the maximum lateral shear at the post-to-foundation interface. Where multiple rods are connected to the same location, the anchorage shall be designed to resist the concurrent tensile loads in the braces.

14.4.7.9.4 Evaluation of structures sensitive to buckling failure. Shell structures that support substantial loads may exhibit a primary mode of failure from localized or general buckling of the support pedestal or skirt during seismic loads. Such structures may include single pedestal water towers, skirt-supported process vessels, and similar single member towers. Where the structural assessment concludes that buckling of the support is the governing primary mode of failure, structures and components assigned to Seismic Use Group III shall be designed to resist the seismic forces as follows:

1. The seismic response coefficient for this evaluation shall be determined in accordance with Sec. 5.2.1.1 with R/I taken equal to 1.0. Soil-structure and fluid-structure interaction may be included when determining the structural response. Vertical or orthogonal combinations need not be considered.
2. The resistance of the structure or component shall be defined as the critical buckling resistance of the element with a factor of safety taken equal to 1.0.
3. The anchorage and foundation shall be designed to resist the load determined in item 1. The foundation shall be proportioned to provide a stability ratio of 1.2 for the overturning moment. The maximum toe pressure under the foundation shall not exceed the lesser of the ultimate bearing capacity or 3 times the allowable bearing capacity. All structural components and elements of the foundation shall be designed to resist the combined loads with a load factor of 1.0 on all loads, including dead load, live load, and earthquake load. Anchors shall be permitted to yield.

14.4.7.9.5 Welded steel. Welded steel elevated water storage structures shall be designed and detailed in accordance with the seismic requirements of AWWA D100 and these *Provisions* except that in using Eq. 13-1 and 13-3 of AWWA D100 S shall be taken equal to 1.0 and the term shall be replaced by the following:

$$\text{For } T < T_s, \frac{S_{DS}I}{1.4R},$$

$$\text{For } T_s \leq T \leq 4.0 \text{ sec, } \frac{S_{DI}I}{T(1.4R)}, \text{ and}$$

$$\text{For } T > 4.0 \text{ sec, } \frac{S_{DI}I}{T^2(1.4R)}.$$

14.4.7.9.5.1 Analysis procedures. The equivalent lateral force procedure may be used. A more rigorous analysis shall be permitted. Analysis of single pedestal structures shall be based on a fixed-

base, single degree-of-freedom model. All mass, including the contents, shall be considered rigid unless the sloshing mechanism (percentage of convective mass and centroid) is determined for the specific configuration of the container by detailed fluid-structure interaction analysis or testing. Soil-structure interaction may be included.

14.4.7.9.5.2 Structure period. The fundamental period of vibration of the structure shall be established using the structural properties and deformational characteristics of the resisting elements in a substantiated analysis. The period used to calculate the seismic response coefficient shall not exceed 4.0 seconds. See AWWA D100 for guidance on computing the fundamental period of cross-braced structures.

14.4.7.9.6 Concrete pedestal (composite) tanks. Concrete pedestal (composite) elevated water storage structures shall be designed in accordance with the requirements of ACI 371 except that the design input forces shall be modified as follows:

1. In Eq. 4-8a of ACI 371,

For $T_s \leq T \leq 4.0$ sec, $\frac{1.2C_v}{RT^{2/3}}$ shall be replaced by $\frac{S_{DI}I}{TR}$, and

For $T > 4.0$ sec, $\frac{1.2C_v}{RT^{2/3}}$ shall be replaced by $\frac{4S_{DI}I}{T^2R}$.

2. In Eq. 4-8b of ACI 371, $\frac{2.5C_a}{R}$ shall be replaced by $\frac{S_{DS}I}{R}$.

3. In Eq. 4-9 of ACI 371, $0.5C_a$ shall be replaced by $0.2S_{DS}$.

14.4.7.9.6.1 Analysis procedures. The equivalent lateral force procedure may be used for all structures and shall be based on a fixed-base, single-degree-of-freedom model. All mass, including that of the contents, shall be considered rigid unless the sloshing mechanism (percentage of convective mass and centroid) is determined for the specific configuration of the container by detailed fluid-structure interaction analysis or testing. Soil-structure interaction may be included. A more rigorous analysis is permitted.

14.4.7.9.6.2 Structure period. The fundamental period of vibration of the structure shall be established using the uncracked structural properties and deformational characteristics of the resisting elements in a properly substantiated analysis. The period used to calculate the seismic response coefficient shall not exceed 2.5 seconds.

14.4.7.10 Boilers and pressure vessels. Supports and attachments for boilers and pressure vessels shall be designed to satisfy the requirements of Chapter 6 and the additional requirements of this section. Boilers and pressure vessels assigned to Seismic Use Group II or III shall be designed to satisfy the force and displacement requirements of Chapter 6.

14.4.7.10.1 ASME boilers and pressure vessels. Boilers and pressure vessels designed and constructed in accordance with ASME BPV shall be deemed to satisfy the seismic force and relative displacement requirements of these *Provisions* provided that the forces and displacements defined in Chapter 6 are used in lieu of the seismic forces and displacements defined in ASME BPV.

14.4.7.10.2 Attachments of internal equipment and refractory. Attachments to the pressure boundary for internal and external ancillary components (refractory, cyclones, trays, etc.) shall be designed to resist the seismic forces in these *Provisions* to safeguard against rupture of the pressure boundary. Alternatively, the element attached to the boiler or pressure vessel may be designed to fail prior to damaging the pressure boundary provided that the pressure boundary is not jeopardized as a consequence of the failure. For boilers or vessels containing liquids, the effect of sloshing on the internal equipment shall be considered if the equipment can damage the pressure boundary.

14.4.7.10.3 Coupling of vessel and support structure. Where the mass of the operating vessel or vessels supported is greater than 25 percent of the total mass of the combined system, the coupling of the masses shall be considered. Coupling with adjacent, connected structures such as multiple towers shall be considered if the structures are interconnected with elements that will transfer loads from one structure to the other.

14.4.7.10.4 Effective mass. Fluid-structure interaction (sloshing) shall be considered in determining the effective mass of the stored material provided that sufficient liquid surface exists for sloshing to occur and the sloshing period, T_c , is greater than $3T$. Changes to or variations in material density with pressure and temperature shall be considered.

14.4.7.10.5 Other boilers and pressure vessels. Boilers and pressure vessels that are assigned to Seismic Use Group III but are not designed and constructed in accordance with the requirements of ASME BPV shall satisfy the following requirements:

1. Provision shall be made to eliminate seismic impact for components vulnerable to impact, for components constructed of nonductile materials, and in cases where material ductility will be reduced due to service conditions (such as low temperature applications).
2. The design strength for seismic loads in combination with other service loads and appropriate environmental effects (such as corrosion) shall be based on the material properties indicated in Table 14.4-3.

Table 14.4-3 Design Material Properties

Material type	Minimum ratio of F_u/F_y	Design material strength	
		Vessel	Threaded Connection ^a
Ductile (such as steel, aluminum, or copper)	1.33 ^b	$0.9F_y$	$0.7F_y$
Semi-ductile	1.2 ^c	$0.7F_y$	$0.5F_y$
Nonductile (such as cast iron, ceramics, or fiberglass)	NA	$0.25F_u$	$0.20F_u$

^a Threaded connection to vessel or support system.
^b Minimum 20 percent elongation per the appropriate ASTM material specification.
^c Minimum 15 percent elongation per the appropriate ASTM material specification.

14.4.7.10.6 Supports and attachments for boilers and pressure vessels. Supports for boilers and pressure vessels and attachments to the pressure boundary shall satisfy the following requirements:

1. Supports and attachments transferring seismic loads shall be constructed of ductile materials suitable for the intended application and environmental conditions.
2. Seismic anchorages embedded in concrete shall be ductile and detailed for cyclic loads.
3. Seismic supports and attachments to structures shall be designed and constructed so that the support or attachment remains ductile throughout the range of reversing seismic lateral loads and displacements.
4. In the design of vessel attachments, consideration shall be given to the potential effects on the vessel and the support due to uneven vertical reactions based on variations in relative stiffness of the support members, dissimilar details, non-uniform shimming, or irregular supports and uneven distribution of lateral forces based on the relative distribution of the resisting elements, the behavior of the connection details, and vessel shear distribution.

The requirements of Sec. 14.4.7.9.4 shall apply.

14.4.7.11 Liquid and gas spheres. Supports and attachments for liquid and gas spheres shall be designed to satisfy the requirements of Chapter 6 and the additional requirements of this section. Spheres assigned to Seismic Use Group II or III shall be designed to satisfy the force and displacement requirements of Chapter 6.

14.4.7.11.1 ASME spheres. Spheres designed and constructed in accordance with Division VIII of ASME BPV shall be deemed to satisfy the seismic force and relative displacement requirements of these *Provisions* provided that the forces and displacements defined in Chapter 6 are used in lieu of the seismic forces and displacements defined in ASME BPV.

14.4.7.11.2 Attachments of internal equipment and refractory. Attachments to the pressure or liquid boundary for internal and external ancillary components (refractory, cyclones, trays, etc.) shall be designed to resist the seismic forces in these *Provisions* to safeguard against rupture of the pressure boundary. Alternatively, the element attached to the sphere may be designed to fail prior to damaging the pressure or liquid boundary provided that the pressure boundary is not jeopardized as a consequence of the failure. For spheres containing liquids, the effect of sloshing on the internal equipment shall be considered if the equipment can damage the pressure boundary.

14.4.7.11.3 Effective mass. Fluid-structure interaction (sloshing) shall be considered in determining the effective mass of the stored material provided that sufficient liquid surface exists for sloshing to occur and the sloshing period, T_s , is greater than $3T$. Changes to or variations in fluid density shall be considered.

14.4.7.11.4 Post and rod supported. For post supported spheres that are cross-braced:

1. The requirements of Sec. 14.4.7.9.3 shall apply.
2. The stiffening effect (reduction in lateral drift) of pre-tensioning of the bracing shall be considered in determining the natural period.
3. The slenderness and local buckling of the posts shall be considered.
4. Local buckling of the sphere shell at the post attachment shall be considered.
5. For spheres storing liquids, bracing connections shall be designed and constructed to develop the minimum published yield strength of the brace. For spheres storing gas vapors only, bracing connections shall be designed for Ω_0 times the maximum design load in the brace. Lateral bracing connections directly attached to the pressure or liquid boundary are prohibited.

14.4.7.11.5 Skirt supported. For skirt supported spheres, the following requirements shall apply:

1. The requirements of Section 14.4.7.9.4 shall apply.
2. The local buckling of the skirt under compressive membrane forces due to axial load and bending moments shall be considered.
3. Penetrations of the skirt support (manholes, piping, etc.) shall be designed and constructed so as to maintain the strength of the skirt without penetrations.

14.4.7.12 Refrigerated gas liquid storage tanks and vessels. The seismic design of the tanks and facilities for the storage of liquefied hydrocarbons and refrigerated liquids is beyond the scope of this section. The design of such tanks is addressed in part by various product and industry standards. See Commentary Sec. 14.1.2.2.

Exception: Low-pressure, welded steel storage tanks for liquefied hydrocarbon gas (such as LPG or butane) and refrigerated liquids (such as ammonia) may be designed in accordance with the requirements of Sec. 14.4.7.7 and API 620.

14.4.7.13 Horizontal, saddle-supported vessels for liquid or vapor storage. Horizontal vessels supported on saddles shall be designed to satisfy the force and displacement requirements of Chapter 6.

14.4.7.13.1 Effective mass. Changes to or variations in material density shall be considered. The design of the supports, saddles, anchorage, and foundation for seismic overturning shall assume the material stored is a rigid mass acting at the volumetric center of gravity.

14.4.7.13.2 Vessel design. Unless a more rigorous analysis is performed:

1. A horizontal vessel with a length-to-diameter ratio of 6 or more may be assumed to be a simply supported beam spanning between the saddles for the purposes of determining the natural period of vibration and global bending moment.
2. For horizontal vessels with a length-to-diameter ratio of less than 6, the effects of “deep beam shear” shall be considered where determining the fundamental period and stress distribution.
3. Local bending and buckling of the vessel shell at the saddle supports due to seismic load shall be considered. The stabilizing effects of internal pressure shall not be considered to increase the buckling resistance of the vessel shell.
4. If the vessel is a combination of liquid and gas storage, the vessel and supports shall be designed both with and without gas pressure acting (assume piping has ruptured and pressure does not exist).

Appendix to Chapter 14

OTHER NONBUILDING STRUCTURES

PREFACE: This appendix is a resource document for future voluntary standards and model code development. The guidelines contained in this appendix represent the current industry design practice for these types of nonbuilding structures.

These sections are included here so that the design community can gain familiarity with the concepts and update their standards. It is hoped that the various consensus design standards will be updated to include the design and construction methodology presented in this appendix. Please direct all feedback on this appendix to the BSSC.

A14.1 GENERAL

A14.1.1 Scope. This appendix includes design requirements for electrical transmission, substation, and distribution structures, telecommunications towers, and buried structures and performance criteria for tanks and vessels.

A14.1.2 References

IEEE 693 Institute of Electrical and Electronics Engineers, *Recommended Practices for Seismic Design of Substations*, Power Engineering Society, Piscataway, New Jersey, 1997.

A14.1.3 Definitions

Base shear: See Sec. 4.1.3.

Buried structures: Subgrade structures such as tanks, tunnels, and pipes.

Dead load: See Sec. 4.1.3.

Registered design professional: See Sec. 2.1.3.

Seismic Use Group: See Sec. 1.1.4.

Structure: See Sec. 1.1.4.

A14.1.4 Notation

C_d See Sec. 4.1.4.

C_S See Sec. 5.1.3.

I See Sec. 1.1.5.

R See Sec. 4.1.4.

S_{DI} See Sec. 3.1.4.

S_{DS} See Sec. 3.1.4.

T See Sec. 4.1.4.

V See Sec. 5.1.3.

W See Sec. 1.1.5.

Ω_0 See Sec. 4.1.4.

A14.2 DESIGN REQUIREMENTS

A14.2.1 Buried structures. Buried structures that are assigned to Seismic Use Group II or III, or warrant special seismic design as determined by the registered design professional, shall be identified in the geotechnical report. Such buried structures shall be designed to resist minimum seismic lateral forces and expected differential displacements determined from a properly substantiated analysis using approved procedures.

A14.3 PERFORMANCE CRITERIA FOR TANKS AND VESSELS

Tanks and vessels shall be designed to meet the minimum post-earthquake performance criteria as specified in Table A14.3-1. These criteria depend on the Seismic Use Group and content-related hazards of the tanks and vessels being considered.

Table A14.3-1 Performance Criteria for Tanks and Vessels

Performance Category ^a	Minimum Post-earthquake Performance
I	The structure shall be permitted to fail if the resulting spill does not pose a threat to the public or to adjoining Category I, II or III structures.
II	The structure shall be permitted to sustain localized damage, including minor leaks, if (a) such damage remains localized and does not propagate; and (b) the resulting leakage does not pose a threat to the public or to adjoining Category I, II or III structures.
III	The structure shall be permitted to sustain minor damage, and its operational systems or components (valves and controls) shall be permitted to become inoperative, if (a) the structure retains its ability to contain 100% of its contents; and (b) the damage is not accompanied by and does not lead to leakage.
IV ^b	The structure shall be permitted to sustain minor damage provided that (a) it shall retain its ability to contain 100% of its contents without leakage; and (b) its operational systems or components shall remain fully operational.
^a Performance Categories I, II, and III correspond to the Seismic Use Groups defined in Sec. 1.2 and tabulated in Table 14.2-1.	
^b For tanks and vessels in Performance Category IV, an Importance Factor, $I = 1.0$ shall be used.	

Chapter 15

STRUCTURES WITH DAMPING SYSTEMS

15.1 GENERAL

15.1.1 Scope. Every structure with a damping system and every portion thereof shall be designed and constructed in accordance with the requirements of these *Provisions* as modified by this Chapter. Where damping devices are used across the isolation interface of a seismically isolated structure, displacements, velocities, and acceleration shall be determined in accordance with Chapter 13.

15.1.2 Definitions

Base: See Sec. 4.1.3.

Base shear: See Sec. 4.1.3.

Component: See Sec. 1.1.4.

Damping device: A flexible structural element of the damping system that dissipates energy due to relative motion of each end of the device. Damping devices include all pins, bolts, gusset plates, brace extensions, and other components required to connect damping devices to the other elements of the structure. Damping devices may be classified as either displacement-dependent or velocity-dependent, or a combination thereof, and may be configured to act in either a linear or nonlinear manner.

Damping system: The collection of structural elements that includes all the individual damping devices, all structural elements or bracing required to transfer forces from damping devices to the base of the structure, and the structural elements required to transfer forces from damping devices to the seismic-force-resisting system.

Design displacement: See Sec. 13.1.2.

Design earthquake ground motion: See Sec. 1.1.4.

Displacement-dependent damping device: The force response of a displacement-dependent damping device is primarily a function of the relative displacement, between each end of the device. The response is substantially independent of the relative velocity between each of the device, and/or the excitation frequency.

Maximum displacement: See Sec. 13.1.2.

Maximum considered earthquake ground motion: See Sec. 3.1.3.

Registered design professional: See Sec. 2.1.3.

Seismic Design Category: See Sec. 1.1.4.

Seismic-force-resisting system: See Sec. 1.1.4.

Seismic forces: See Sec. 1.1.4.

Seismic response coefficient: See Sec. 5.1.2.

Site Class: See Sec. 3.1.3.

Structure: See Sec. 1.1.4.

Total design displacement: See Sec. 13.1.2.

Total maximum displacement: See Sec. 13.1.2.

Velocity-dependent damping device: The force-displacement relation for a velocity-dependent damping device is primarily a function of the relative velocity between each end of the device, and may also be a function of the relative displacement between each end of the device.

15.1.3 Notation

B_{ID}	Numerical coefficient as set forth in Table 15.6-1 for effective damping equal to β_{mI} ($m=1$) and period of structure equal to T_{ID} .
B_{IE}	Numerical coefficient as set forth in Table 15.6-1 for the effective damping equal to $\beta_I + \beta_{VI}$ and period equal to T_I .
B_{IM}	Numerical coefficient as set forth in Table 15.6-1 for effective damping equal to β_{mM} ($m=1$) and period of structure equal to T_{IM} .
B_{mD}	Numerical coefficient as set forth in Table 15.6-1 for effective damping equal to β_{mI} and period of structure equal to T_m .
B_{mM}	Numerical coefficient as set forth in Table 15.6-1 for effective damping equal to β_{mM} and period of structure equal to T_m .
B_R	Numerical coefficient as set forth in Table 15.6-1 for effective damping equal to β_R and the period of structure equal to T_R .
B_{V+I}	Numerical coefficient as set forth in Table 15.6-1 for effective damping equal to the sum of viscous damping in the fundamental mode of vibration of the structure in the direction of interest, β_{Vm} ($m = 1$), plus inherent damping, β_I , and period of structure equal to T_I .
C_d	See Sec. 4.1.4.
C_{mFD}	Force coefficient as set forth in Table 15.7-1.
C_{mFV}	Force coefficient as set forth in Table 15.7-2.
C_{SI}	Seismic response coefficient of the fundamental mode of vibration of the structure in the direction of interest, Sec. 15.4.2.4 or Sec. 15.5.2.4 ($m = 1$).
C_{Sm}	Seismic response coefficient of the m^{th} mode of vibration of the structure in the direction of interest, Sec. 15.4.2.4 ($m = 1$) or Sec. 15.4.2.6 ($m > 1$).
C_{SR}	Seismic response coefficient of the residual mode of vibration of the structure in the direction of interest, Sec. 15.5.2.8.
D_{ID}	Fundamental mode design displacement at the center rigidity of the roof level of structure in the direction under consideration, Sec. 15.5.3.2.
D_{IM}	Fundamental mode maximum displacement at the center of rigidity of the roof level of the structure in the direction under consideration, Sec. 15.5.3.5.
D_{mD}	Design displacement at the center of rigidity of the roof level of the structure due to the m^{th} mode of vibration in the direction under consideration, Sec. 15.4.3.2.
D_{mM}	Maximum displacement at the center of rigidity of the roof level of the structure due to the m^{th} mode of vibration in the direction under consideration, Sec. 15.4.3.5.
D_{RD}	Residual mode design displacement at the center of rigidity of the roof level of the structure in the direction under consideration, Sec. 15.5.3.2.
D_{RM}	Residual mode maximum displacement at the center of rigidity of the roof level of the structure in the direction under consideration, Sec. 15.5.3.5.
D_Y	Displacement at the center of rigidity of the roof level of the structure at the effective yield point of the seismic-force-resisting system, Sec. 15.6.3.

E_{loop}	See Sec. 13.1.3.
f_i	Lateral force at Level i of the structure distributed approximately in accordance with Sec. 5.2.3, Sec. 15.5.2.3.
F_{iI}	Inertial force at Level i (or mass point i) in the fundamental mode of vibration of the structure in the direction of interest, Sec. 15.5.2.9.
F_{im}	Inertial force at Level i (or mass point i) in the m^{th} mode of vibration of the structure in the direction of interest, Sec. 15.4.2.7.
F_{iR}	Inertial force at Level i (or mass point i) in the residual mode of vibration of the structure in the direction of interest, Sec. 15.5.2.9.
h_i	See Sec. 5.1.3.
h_r	Height of the structure above the base to the roof level, Sec. 15.5.2.3.
I	See Sec. 1.1.5.
q_H	Hysteresis loop adjustment factor as determined in Sec. 15.6.2.2.1.
m	See Sec. 5.1.3.
Q_{DSD}	Force in an element of the damping system required to resist design seismic forces of displacement-dependent damping devices, Sec. 15.7.3.3.
Q_E	See Sec. 4.1.4.
Q_{mDSV}	Forces in an element of the damping system required to resist design seismic forces of velocity-dependent damping devices due to the m^{th} mode of vibration of structure in the direction of interest, Sec. 15.7.3.3.
Q_{mSFRS}	Force in a element of the damping system equal to the design seismic force of the m^{th} mode of vibration of the seismic force resisting system in the direction of interest, 15.7.3.3.
R	See Sec. 4.1.4.
S_I	See Sec. 3.1.4.
S_{DI}	See Sec. 3.1.4.
S_{DS}	See Sec. 3.1.4.
S_{MI}	See Sec. 3.1.4.
S_{MS}	See Sec. 3.1.4.
T_0	See Sec. 3.1.4.
T_I	See Sec. 15.5.2.3.
T_{ID}	Effective period, in seconds, of the fundamental mode of vibration of the structure at the design displacement in the direction under consideration, as prescribed by Sec. 15.4.2.5 or Sec. 15.5.2.5.
T_{IM}	Effective period, in seconds, of the fundamental mode of vibration of the structure at the maximum displacement in the direction under consideration, as prescribed by Sec. 15.4.2.5 or Sec. 15.5.2.5.
T_m	See Sec. 5.1.3.
T_R	Period, in seconds, of the residual mode of vibration of the structure in the direction under consideration, Sec. 15.5.2.7.
T_S	See Sec. 3.1.4.

V	See Sec. 5.1.3.
V_m	Design value of the seismic base shear of the m^{th} mode of vibration of the structure in the direction of interest, Sec. 5.3.4 or Sec. 15.4.2.2.
V_{min}	Minimum allowable value of base shear permitted for design of the seismic-force-resisting system of the structure in the direction of interest, Sec. 15.2.2.1.
V_R	Design value of the seismic base shear of the residual mode of vibration of the structure in a given direction, as determined in Sec. 15.5.2.6.
W	See Sec. 1.1.5.
\bar{W}_I	Effective fundamental mode seismic weight determined in accordance with Eq. 5.3-2 for $m = 1$.
\bar{W}_R	Effective residual mode seismic weight determined in accordance with Eq. 15.5-13.
w_i	See Sec. 4.1.4.
w_x	See Sec. 1.1.5.
α	Velocity exponent relating damping device force to damping device velocity.
β_{mD}	Total effective damping of the m^{th} mode of vibration of the structure in the direction of interest at the design displacement, Sec. 15.6.2.
β_{mM}	Total effective damping of the m^{th} mode of vibration of the structure in the direction of interest at the maximum displacement, Sec. 15.6.2.
β_{HD}	Component of effective damping of the structure in the direction of interest due to post-yield hysteric behavior of the seismic-force-resisting system and elements of the damping system at effective ductility demand μ_D , Sec. 15.6.2.2.
β_{HM}	Component of effective damping of the structure in the direction of interest due to post-yield hysteric behavior of the seismic-force-resisting system and elements of the damping system at effective ductility demand, μ_M , Sec. 15.6.2.2.
β_I	Component of effective damping of the structure due to the inherent dissipation of energy by elements of the structure, at or just below the effective yield displacement of the seismic-force-resisting system, Sec. 15.6.2.1.
β_R	Total effective damping in the residual mode of vibration of the structure in the direction of interest, calculated in accordance with Sec. 15.6.2 ($\mu_D = 1.0$ and $\mu_M = 1.0$).
β_{Vm}	Component of effective damping of the m^{th} mode of vibration of the structure in the direction of interest due to viscous dissipation of energy by the damping system, at or just below the effective yield displacement of the seismic-force-resisting system, Sec. 15.6.2.3.
δ_i	Elastic deflection of Level i of the structure due to applied lateral force, f_i , Sec. 15.5.2.3.
δ_{iD}	Fundamental mode design earthquake deflection of Level i at the center of rigidity of the structure in the direction under consideration, Sec. 15.5.3.1.
δ_D	Total design earthquake deflection of Level i at the center of rigidity of the structure in the direction under consideration, Sec. 15.5.3.
δ_M	Total maximum earthquake deflection of Level i at the center of rigidity of the structure in the direction under consideration, Sec. 15.5.3.
δ_{RD}	Residual mode design earthquake deflection of Level i at the center of rigidity of the structure in the direction under consideration, Sec. 15.5.3.

δ_{im}	Deflection of Level i in the m^{th} mode of vibration at the center of rigidity of the structure in the direction under consideration, Sec. 15.6.2.3.
Δ_{ID}	Design earthquake story drift due to the fundamental mode of vibration of the structure in the direction of interest, Sec. 15.5.3.3.
Δ_D	Total design earthquake story drift of the structure in the direction of interest, Sec. 15.5.3.3.
Δ_M	Total maximum earthquake story drift of the structure in the direction of interest, Sec. 15.5.3.
Δ_{mD}	Design earthquake story drift due to the m^{th} mode of vibration of the structure in the direction of interest, Sec. 15.4.3.3.
Δ_{RD}	Design earthquake story drift due to the residual mode of vibration of the structure in the direction of interest, Sec. 15.5.3.3.
μ	Effective ductility demand on the seismic-force-resisting system in the direction of interest.
μ_D	Effective ductility demand on the seismic-force-resisting system in the direction of interest due to the design earthquake, Sec. 15.6.3.
μ_M	Effective ductility demand on the seismic-force-resisting system in the direction of interest due to the maximum considered earthquake, Sec. 15.6.3.
μ_{max}	Maximum allowable effective ductility demand on the seismic-force-resisting system due to design earthquake, Sec. 15.6.4.
ρ	See Sec. 4.1.4.
ϕ_{iI}	Displacement amplitude at Level i of the fundamental mode of vibration of the structure in the direction of interest, normalized to unity at the roof level, Sec. 15.5.2.3.
ϕ_{iR}	Displacement amplitude at Level i of the residual mode of vibration of the structure in the direction of interest normalized to unity at the roof level, Sec. 15.5.2.7.
Γ_I	Participation factor of fundamental mode of vibration of the structure in the direction of interest, Sec. 15.4.2.3 or Sec. 15.5.2.3 ($m = 1$).
Γ_m	Participation factor on the m^{th} mode of vibration of the structure in the direction of interest, Sec. 15.4.2.3.
Γ_R	Participation factor of the residual mode of vibration of the structure in the direction of interest, Sec. 15.5.2.7.
Ω_0	See Sec. 4.1.4.
∇_{ID}	Design earthquake story velocity due to the fundamental mode of vibration of the structure in the direction of interest, Sec. 15.5.3.4.
∇_D	Total design earthquake story velocity of the structure in the direction of interest, Sec. 15.4.3.4.
∇_M	Total maximum earthquake story velocity of the structure in the direction of interest, Sec. 15.5.3.
∇_{mD}	Design earthquake story velocity due to the m^{th} mode of vibration of the structure in the direction of interest, Sec. 15.4.3.4.

15.2 GENERAL DESIGN REQUIREMENTS

15.2.1 Seismic Design Category A. Seismic Design Category A structures with a damping system shall be designed using the design spectral response acceleration determined in accordance with Sec. 3.3.3 and the analysis methods and design provisions required for Seismic Design Category B structures.

15.2.2 System requirements. Design of the structure shall consider the basic requirements for the seismic-force-resisting system and the damping system as defined in the following sections. The seismic-force-resisting system shall have the required strength to meet the forces defined in Section 15.2.2.1. The combination of the seismic-force-resisting system and the damping system may be used to meet the drift requirement.

15.2.2.1 Seismic-force-resisting system. Structures that contain a damping system are required to have a basic seismic-force-resisting system that, in each lateral direction, conforms to one of the types indicated in Table 4.3-1.

The design of the seismic-force-resisting system in each direction shall satisfy the requirements of Sec. 15.7 and the following:

1. The seismic base shear used for design of the seismic-force-resisting system shall not be less than V_{min} , where V_{min} is determined as the greater of the values computed using Eq. 15.2-1 and 15.2-2 as follows:

$$V_{min} = \frac{V}{B_{V+l}} \quad (15.2-1)$$

$$V_{min} = 0.75V \quad (15.2-2)$$

where:

V = seismic base shear in the direction of interest, determined in accordance with Sec. 5.2,

B_{V+l} = numerical coefficient as set forth in Table 15.6-1 for effective damping equal to the sum of viscous damping in the fundamental mode of vibration of the structure in the direction of interest, $\beta_{Vm}(m=1)$, plus inherent damping, β_l , and period of structure equal to T_l .

Exception: The seismic base shear used for design of the seismic-force-resisting system shall not be taken as less than $1.0V$, if either of the following conditions apply:

- a. In the direction of interest, the damping system has less than two damping devices on each floor level, configured to resist torsion.
 - b. The seismic-force-resisting system has plan irregularity Type 1b (Table 4.3-2) or vertical irregularity Type 1b (Table 4.3-3).
2. Minimum strength requirements for elements of the seismic-force-resisting system that are also elements of the damping system or are otherwise required to resist forces from damping devices shall meet the additional requirements of Sec. 15.7.2.

15.2.2.2 Damping system. Elements of the damping system shall be designed to remain elastic for design loads including unreduced seismic forces of damping devices as required in Sec. 15.7.2, unless it is shown by analysis or test that inelastic response of elements would not adversely affect damping system function and inelastic response is limited in accordance with the requirements of Sec. 15.7.2.4.

15.2.3 Ground motion

15.2.3.1 Design spectra. Spectra for the design earthquake and the maximum considered earthquake developed in accordance with Sec. 13.2.3.1 shall be used for the design and analysis of all structures with a damping system. Site-specific design spectra shall be developed and used for design of all structures with a damping system if either of the following conditions apply:

1. The structure is located on a Class F site or
2. The structure is located at a site with S_l greater than 0.6.

15.2.3.2 Time histories. Ground-motion time histories for the design earthquake and the maximum considered earthquake developed in accordance with Sec. 13.2.3.2 shall be used for design and analysis of all structures with a damping system if either of the following conditions apply:

1. The structure is located at a site with S_I greater than 0.6.
2. The damping system is explicitly modeled and analyzed using the time history analysis method.

15.2.4 Procedure selection

All structures with a damping system shall be designed using linear procedures, nonlinear procedures, or a combination of linear and nonlinear procedures, as permitted in this section.

Regardless of the analysis method used, the peak dynamic response of the structure and elements of the damping system shall be confirmed by using the nonlinear response history procedure if the structure is located at a site with S_I greater than 0.6.

15.2.4.1 Nonlinear procedures. The nonlinear procedures of Sec. 15.3 are permitted to be used for design of all structures with damping systems.

15.2.4.2 Response spectrum procedure. The response spectrum procedure of Sec. 15.4 is permitted to be used for design of structures with damping systems provided that:

1. In the direction of interest, the damping system has at least two damping devices in each story, configured to resist torsion; and
2. The total effective damping of the fundamental mode, $\beta_{mD}(m = 1)$, of the structure in the direction of interest is not greater than 35 percent of critical.

15.2.4.3 Equivalent lateral force procedure. The equivalent lateral force procedure of Sec. 15.5 is permitted to be used for design of structures with damping systems provided that:

1. In the direction of interest, the damping system has at least two damping devices in each story, configured to resist torsion;
2. The total effective damping of the fundamental mode, $\beta_{mD}(m = 1)$, of the structure in the direction of interest is not greater than 35 percent of critical;
3. The seismic-force-resisting system does not have plan irregularity Type 1a or 1b (Table 4.3-2) or vertical irregularity Type 1a, 1b, 2, or 3 (Table 4.3-3);
4. Floor diaphragms are rigid as defined in Sec. 4.3.2.1; and
5. The height of the structure above the base does not exceed 100 ft (30 m).

15.2.5 Damping system

15.2.5.1 Device design. The design, construction, and installation of damping devices shall be based on maximum earthquake response and the following conditions:

1. Low-cycle, large-displacement degradation due to seismic loads;
2. High-cycle, small-displacement degradation due to wind, thermal, or other cyclic loads;
3. Forces or displacements due to gravity loads;
4. Adhesion of device parts due to corrosion or abrasion, biodegradation, moisture, or chemical exposure; and
5. Exposure to environmental conditions, including but not limited to temperature, humidity, moisture, radiation (e.g., ultraviolet light), and reactive or corrosive substances (e.g., salt water).

Damping devices subject to failure by low-cycle fatigue shall resist wind forces without slip, movement, or inelastic cycling.

The design of damping devices shall incorporate the range of thermal conditions, device wear, manufacturing tolerances, and other effects that cause device properties to vary during the design life of the device.

15.2.5.2 Multi-axis movement. Connection points of damping devices shall provide sufficient articulation to accommodate simultaneous longitudinal, lateral, and vertical displacements of the damping system.

15.2.5.3 Inspection and periodic testing. Means of access for inspection and removal of all damping devices shall be provided.

The registered design professional responsible for design of the structure shall establish an appropriate inspection and testing schedule for each type of damping device to ensure that the devices respond in a dependable manner throughout the design life. The degree of inspection and testing shall reflect the established in-service history of the damping devices, and the likelihood of change in properties over the design life of devices.

15.2.5.4 Quality control. As part of the quality assurance plan developed in accordance with Sec. 2.2.1, the registered design professional responsible for the structural design shall establish a quality control plan for the manufacture of damping devices. As a minimum, this plan shall include the testing requirements of Sec. 15.9.2.

15.3 NONLINEAR PROCEDURES

The stiffness and damping properties of the damping devices used in the models shall be based on or verified by testing of the damping devices as specified in Sec. 15.9. The nonlinear force-deflection characteristics of damping devices shall be modeled, as required, to explicitly account for device dependence on frequency, amplitude, and duration of seismic loading.

15.3.1 Nonlinear response history procedure. A nonlinear response history (time history) analysis shall utilize a mathematical model of the structure and the damping system as provided in Sec. 5.5.1 and this section. The model shall directly account for the nonlinear hysteretic behavior of elements of the structure and the damping devices to determine its response, through methods of numerical integration, to suites of ground motions compatible with the design response spectrum for the site.

The analysis shall be performed in accordance with Sec. 5.5 together with the requirements of this section. Inherent damping of the structure shall not be taken greater than five percent of the critical unless test data consistent with the levels of deformation at or just below the effective yield displacement of the seismic-force-resisting system support higher values.

If the calculated force in the element of the seismic-force-resisting system does not exceed 1.5 times its nominal strength, that element may be modeled as linear.

15.3.1.1 Damping device modeling. Mathematical models of displacement-dependent damping devices shall include the hysteretic behavior of the devices consistent with test data and accounting for all significant changes in strength, stiffness, and hysteretic loop shape. Mathematical models of velocity-dependent damping devices shall include the velocity coefficient consistent with test data. If this coefficient changes with time and/or temperature, such behavior shall be modeled explicitly. The elements of damping devices connecting damper units to the structure shall be included in the model.

Exception: If the properties of the damping devices are expected to change during the duration of the time history analysis, the dynamic response may be enveloped by the upper and lower limits of device properties. All these limit cases for variable device properties must satisfy the same conditions as if the time dependent behavior of the devices were explicitly modeled.

15.3.1.2 Response parameters. In addition to the response parameters given in Sec. 5.5.3 for each ground motion analyzed, individual response parameters consisting of the maximum value of the discrete damping device forces, displacements, and velocities, in the case of velocity-dependent devices, shall be determined.

If at least seven ground motions are analyzed, the design values of the damping device forces, displacements, and velocities shall be permitted to be taken as the average of the values determined by the analyses. If fewer than seven ground motions are analyzed, the design damping device forces, displacements, and velocities shall be taken as the maximum value determined by the analysis. A minimum of three ground motions shall be used.

15.3.2 Nonlinear static procedure. The nonlinear modeling described in Sec. A5.2.1 and the lateral loads described in Sec. A5.2.2 shall be applied to the seismic-force-resisting system. The resulting force-displacement curve shall be used in lieu of the assumed effective yield displacement, D_y , of Eq. 15.6-10 to calculate the effective ductility demand due to the design earthquake, μ_D , and due to the maximum considered earthquake, μ_M , in Equations 15.6-8 and 15.6-9, respectively. The value of (R/C_d) shall be taken as 1.0 in Eq. 15.4-4, 15.4-5, 15.4-8, and 15.4-9 for the response spectrum procedure, and in Eq. 15.5-6, 15.5-7 and 15.5-15 for the equivalent lateral force procedure.

15.4 RESPONSE SPECTRUM PROCEDURE

Where the response spectrum procedure is used to design structures with a damping system, the requirements of this section shall apply.

15.4.1 Modeling. A mathematical model of the seismic-force-resisting system and damping system shall be constructed that represents the spatial distribution of mass, stiffness and damping throughout the structure. The model and analysis shall comply with the requirements of Sec. 5.3.1 through 5.3.3 for the seismic-force-resisting system and to the requirements of this section for the damping system. The stiffness and damping properties of the damping devices used in the models shall be based on or verified by testing of the damping devices as specified in Sec. 15.9.

The elastic stiffness of elements of the damping system other than damping devices shall be explicitly modeled. Stiffness of damping devices shall be modeled depending on damping device type as follows:

1. *Displacement-Dependent Damping Devices:* Displacement-dependent damping devices shall be modeled with an effective stiffness that represents damping device force at the response displacement of interest (e.g., design story drift). Alternatively, the stiffness of hysteretic and friction damping devices may be excluded from response spectrum analysis provided design forces in displacement-dependent damping devices, Q_{DSD} , are applied to the model as external loads (Sec. 15.7.2.3).
2. *Velocity-Dependent Damping Devices:* Velocity-dependent damping devices that have a stiffness component (e.g., visco-elastic damping devices) shall be modeled with an effective stiffness corresponding to the amplitude and frequency of interest.

15.4.2 Seismic-force-resisting system

15.4.2.1 Seismic base shear. The seismic base shear, V , of the structure in a given direction shall be determined as the combination of modal components, V_m , subject to the limits of Eq. 15.4-1 as follows:

$$V \geq V_{min} \quad (15.4-1)$$

The seismic base shear, V , of the structure shall be determined by the square root sum of the squares or complete quadratic combination of modal base shear components, V_m .

15.4.2.2 Modal base shear. Modal base shear of the m^{th} mode of vibration, V_m , of the structure in the direction of interest shall be determined in accordance with Eq. 15.4-2 as follows:

$$V_m = C_{sm} \bar{W}_m \quad (15.4-2)$$

where:

C_{sm} = seismic response coefficient of the m^{th} mode of vibration of the structure in the direction of interest as determined from Sec. 15.4.2.4 ($m = 1$) or Sec. 15.4.2.6 ($m > 1$), and

\bar{W}_m = the effective gravity load of the m^{th} mode of vibration of the structure determined in accordance with Eq. 5.3-2.

15.4.2.3 Modal participation factor. The modal participation factor of the m^{th} mode of vibration, Γ_m , of the structure in the direction of interest shall be determined in accordance with Eq. 15.4-3 as follows:

$$\Gamma_m = \frac{\bar{W}_m}{\sum_{i=1}^n w_i \phi_{im}} \quad (15.4-3)$$

where:

ϕ_{im} = displacement amplitude at the i^{th} level of the structure for the fixed base condition in the m^{th} mode of vibration in the direction of interest, normalized to unity at the roof level.

15.4.2.4 Fundamental mode seismic response coefficient. The fundamental mode ($m = 1$) seismic response coefficient, C_{s1} , in the direction of interest shall be determined in accordance with Eq. 15.4-4 and 15.4-5 as follows:

$$\text{For } T_{1D} < T_s, C_{s1} = \left(\frac{R}{C_d} \right) \frac{S_{DS}}{\Omega_0 B_{1D}} \quad (15.4-4)$$

$$\text{For } T_{1D} \geq T_s, C_{s1} = \left(\frac{R}{C_d} \right) \frac{S_{D1}}{T_{1D} (\Omega_0 B_{1D})} \quad (15.4-5)$$

15.4.2.5 Effective fundamental mode period determination. The effective fundamental mode ($m = 1$) period at the design earthquake, T_{1D} , and at the maximum considered earthquake, T_{1M} , shall be based either on explicit consideration of the post-yield nonlinear force deflection characteristics of the structure or determined in accordance with Eq. 15.4-6 and 15.4-7 as follows:

$$T_{1D} = T_1 \sqrt{\mu_D} \quad (15.4-6)$$

$$T_{1M} = T_1 \sqrt{\mu_M} \quad (15.4-7)$$

15.4.2.6 Higher mode seismic response coefficient. Higher mode ($m > 1$) seismic response coefficient, C_{sm} , of the m^{th} mode of vibration ($m > 1$) of the structure in the direction of interest shall be determined in accordance with Eq. 15.4-8 and 15.4-9 as follows:

$$\text{For } T_m < T_s, C_{sm} = \left(\frac{R}{C_d} \right) \frac{S_{DS}}{\Omega_0 B_{mD}} \quad (15.4-8)$$

$$\text{For } T_m \geq T_s, C_{sm} = \left(\frac{R}{C_d} \right) \frac{S_{D1}}{T_m (\Omega_0 B_{mD})} \quad (15.4-9)$$

where:

T_m = period, in seconds, of the m^{th} mode of vibration of the structure in the direction under consideration, and

B_{mD} = numerical coefficient as set forth in Table 15.6-1 for effective damping equal to β_{mD} and period of the structure equal to T_m .

15.4.2.7 Design lateral force. Design lateral force at Level i due to m^{th} mode of vibration, F_{im} , of the structure in the direction of interest shall be determined in accordance with Eq. 15.4-10 as follows:

$$F_{im} = w_i \phi_{im} \frac{\Gamma_m}{\bar{W}_m} V_m \quad (15.4-10)$$

Design forces in elements of the seismic-force-resisting system shall be determined by the square root of the sum of the squares or complete quadratic combination of modal design forces.

15.4.3 Damping system. Design forces in damping devices and other elements of the damping system shall be determined on the basis of the floor deflection, story drift and story velocity response parameters described in the following sections.

Displacements and velocities used to determine maximum forces in damping devices at each story shall account for the angle of orientation from horizontal and consider the effects of increased response due to torsion required for design of the seismic-force-resisting system.

Floor deflections at Level i , δ_{iD} and δ_{iM} , design story drifts, Δ_D and Δ_M , and design story velocities, ∇_D and ∇_M , shall be calculated for both the design earthquake and the maximum considered earthquake, respectively, in accordance with this section.

15.4.3.1 Design earthquake floor deflection. The deflection of structure due to the design earthquake at Level i in the m^{th} mode of vibration, δ_{imD} , of the structure in the direction of interest shall be determined in accordance with Eq. 15.4-11 as follows:

$$\delta_{imD} = D_{mD}\phi_{im} \quad (15.4-11)$$

The total design earthquake deflection at each floor of the structure shall be calculated by the square root of the sum of the squares or complete quadratic combination of modal design earthquake deflections.

15.4.3.2 Design earthquake roof displacement. Fundamental ($m = 1$) and higher mode ($m > 1$) roof displacements due to the design earthquake, D_{1D} and D_{mD} , of the structure in the direction of interest shall be determined in accordance with Eq. 15.4-12 and 15.4-13 as follows:

For $m=1$,

$$D_{1D} = \left(\frac{g}{4\pi^2} \right) \Gamma_1 \frac{S_{DS}T_{1D}^2}{B_{1D}} \geq \left(\frac{g}{4\pi^2} \right) \Gamma_1 \frac{S_{DS}T_1^2}{B_{1E}}, \quad T_{1D} < T_s \quad (15.4-12a)$$

$$D_{1D} = \left(\frac{g}{4\pi^2} \right) \Gamma_1 \frac{S_{D1}T_{1D}}{B_{1D}} \geq \left(\frac{g}{4\pi^2} \right) \Gamma_1 \frac{S_{D1}T_1}{B_{1E}}, \quad T_{1D} \geq T_s \quad (15.4-12b)$$

$$\text{For } m > 1, \quad D_{mD} = \left(\frac{g}{4\pi^2} \right) \Gamma_m \frac{S_{D1}T_m}{B_{mD}} \leq \left(\frac{g}{4\pi^2} \right) \Gamma_m \frac{S_{DS}T_m^2}{B_{mD}} \quad (15.4-13)$$

15.4.3.3 Design earthquake story drift. Design earthquake story drift of the fundamental mode, Δ_{1D} , and higher modes, Δ_{mD} ($m > 1$), of the structure in the direction of interest shall be calculated in accordance with Sec. 5.2.6.1 using modal roof displacements of Sec. 15.4.3.2.

Total design earthquake story drift, Δ_D , shall be determined by the square root of the sum of the squares or complete quadratic combination of modal design earthquake drifts.

15.4.3.4 Design earthquake story velocity. Design earthquake story velocity of the fundamental mode, ∇_{1D} , and higher modes, ∇_{mD} ($m > 1$), of the structure in the direction of interest shall be calculated in accordance with Eq. 15.4-14 and 15.4-15 as follows:

$$\text{For } m = 1, \quad \nabla_{1D} = 2\pi \frac{\Delta_{1D}}{T_{1D}} \quad (15.4-14)$$

$$\text{For } m > 1, \nabla_{mD} = 2\pi \frac{A_{mD}}{T_m} \quad (15.4-15)$$

Total design earthquake story velocity, ∇_D , shall be determined by the square root of the sum of the squares or complete quadratic combination of modal design earthquake velocities.

15.4.3.5 Maximum earthquake response. Total modal maximum earthquake floor deflection at Level i , design story drift values and design story velocity values shall be based on Sec. 15.4.3.1, 15.4.3.3 and 15.4.3.4, respectively, except design earthquake roof displacement shall be replaced by maximum earthquake roof displacement. Maximum earthquake roof displacement of the structure in the direction of interest shall be calculated in accordance with Eq. 15.4-16 and 15.4-17 as follows:

For $m=1$,

$$D_{1M} = \left(\frac{g}{4\pi^2} \right) \Gamma_1 \frac{S_{MS} T_{1M}^2}{B_{1M}} \geq \left(\frac{g}{4\pi^2} \right) \Gamma_1 \frac{S_{MS} T_1^2}{B_{1E}}, \quad T_{1M} < T_S \quad (15.4-16a)$$

$$D_{1M} = \left(\frac{g}{4\pi^2} \right) \Gamma_1 \frac{S_{M1} T_{1M}}{B_{1M}} \geq \left(\frac{g}{4\pi^2} \right) \Gamma_1 \frac{S_{M1} T_1}{B_{1E}}, \quad T_{1M} \geq T_S \quad (15.4-16b)$$

$$\text{For } m > 1, D_{mM} = \left(\frac{g}{4\pi^2} \right) \Gamma_m \frac{S_{M1} T_m}{B_{mM}} \leq \left(\frac{g}{4\pi^2} \right) \Gamma_m \frac{S_{MS} T_m^2}{B_{mM}} \quad (15.4-17)$$

where:

B_{mM} = numerical coefficient as set forth in Table 15.6-1 for effective damping equal to β_{mM} and period of the structure equal to T_m .

15.5 EQUIVALENT LATERAL FORCE PROCEDURE

Where the equivalent lateral force procedure is used to design structures with a damping system, the requirements of this section shall apply.

15.5.1 Modeling. Elements of the seismic-force-resisting system shall be modeled in a manner consistent with the requirements of Sec. 5.2. For purposes of analysis, the structure shall be considered to be fixed at the base.

Elements of the damping system shall be modeled as required to determine design forces transferred from damping devices to both the ground and the seismic-force-resisting system. The effective stiffness of velocity-dependent damping devices shall be modeled.

Damping devices need not be explicitly modeled provided effective damping is calculated in accordance with the procedures of Sec. 15.6 and used to modify response as required in Sec. 15.5.2 and 15.5.3.

The stiffness and damping properties of the damping devices used in the models shall be based on or verified by testing of the damping devices as specified in Sec. 15.9.

15.5.2 Seismic-force-resisting system

15.5.2.1 Seismic base shear. The seismic base shear, V , of the seismic-force-resisting system in a given direction shall be determined as the combination of the two modal components, V_I and V_R , in accordance with the following equation:

$$V = \sqrt{V_I^2 + V_R^2} \geq V_{min} \quad (15.5-1)$$

where:

- V_I = design value of the seismic base shear of the fundamental mode in a given direction of response, as determined in Sec. 15.5.2.2,
- V_R = design value of the seismic base shear of the residual mode in a given direction, as determined in Sec. 15.5.2.6, and
- V_{min} = minimum allowable value of base shear permitted for design of the seismic-force-resisting system of the structure in direction of the interest, as determined in Sec. 15.2.2.1.

15.5.2.2 Fundamental mode base shear. The fundamental mode base shear, V_I , shall be determined in accordance with the following equation:

$$V_I = C_{SI} \bar{W}_I \quad (15.5-2)$$

where:

- C_{SI} = the fundamental mode seismic response coefficient, as determined in Sec. 15.5.2.4, and
- \bar{W}_I = the effective fundamental mode gravity load including portions of the live load as defined by Eq. 5.3-2 for $m = 1$.

15.5.2.3 Fundamental mode properties. The fundamental mode shape, ϕ_{i1} , and participation factor, Γ_1 , shall be determined by either dynamic analysis using the elastic structural properties and deformational characteristics of the resisting elements or using Eq. 15.5-3 and 15.5-4 as follows:

$$\phi_{i1} = \frac{h_i}{h_r} \quad (15.5-3)$$

$$\Gamma_1 = \frac{\bar{W}_I}{\sum_{i=1}^n w_i \phi_{i1}} \quad (15.5-4)$$

where:

- h_i = the height of the structure above the base to Level i ,
- h_r = the height of the structure above the base to the roof level,
- w_i = the portion of the total gravity load, W , located at or assigned to Level i .

The fundamental period, T_1 , shall be determined either by dynamic analysis using the elastic structural properties and deformational characteristics of the resisting elements, or using Eq. 15.5-5 as follows:

$$T_1 = 2\pi \sqrt{\frac{\sum_{i=1}^n w_i \delta_i^2}{g \sum_{i=1}^n f_i \delta_i}} \quad (15.5-5)$$

where:

- f_i = lateral force at Level i of the structure distributed in accordance with Sec. 5.2.3, and
- δ_i = elastic deflection at Level i of the structure due to applied lateral forces f_i .

15.5.2.4 Fundamental mode seismic response coefficient. The fundamental mode seismic response coefficient, C_{SI} , shall be determined using Eq. 15.5-6 or 15.5-7 as follows:

$$\text{For } T_{1D} < T_S, C_{SI} = \left(\frac{R}{C_d} \right) \frac{S_{DI}}{\Omega_0 B_{1D}} \quad (15.5-6)$$

$$\text{For } T_{ID} \geq T_S, C_{SI} = \left(\frac{R}{C_d} \right) \frac{S_{DI}}{T_{ID} (\Omega_0 B_{ID})} \quad (15.5-7)$$

where:

- S_{DS} = the design spectral response acceleration parameter in the short period range,
 S_{DI} = the design spectral response acceleration parameter at a period of 1 second, and
 B_{ID} = numerical coefficient as set forth in Table 15.6-1 for effective damping equal to β_{mD} ($m = 1$) and period of the structure equal to T_{ID} .

15.5.2.5 Effective fundamental mode period determination. The effective fundamental mode period at the design earthquake, T_{ID} , and at the maximum considered earthquake, T_{IM} , shall be based on explicit consideration of the post-yield force deflection characteristics of the structure or shall be calculated using Eq. 15.5-8 and 15.5-9 as follows:

$$T_{ID} = T_I \sqrt{\mu_D} \quad (15.5-8)$$

$$T_{IM} = T_I \sqrt{\mu_M} \quad (15.5-9)$$

15.5.2.6 Residual mode base shear. Residual mode base shear, V_R , shall be determined in accordance with Eq. 15.5-10 as follows:

$$V_R = C_{SR} \bar{W}_R \quad (15.5-10)$$

where:

- C_{SR} = the residual mode seismic response coefficient as determined in Sec. 15.5.2.8, and
 \bar{W}_R = the effective residual mode gravity load of the structure determined using Eq. 15.5-13.

15.5.2.7 Residual mode properties. Residual mode shape, ϕ_{iR} , participation factor, Γ_R , effective gravity load of the structure, \bar{W}_R , and effective period, T_R , shall be determined using Eq. 15.5-11 through 15.5-14 as follows:

$$\phi_{iR} = \frac{1 - \Gamma_I \phi_{iI}}{1 - \Gamma_I} \quad (15.5-11)$$

$$\Gamma_R = 1 - \Gamma_I \quad (15.5-12)$$

$$\bar{W}_R = W - \bar{W}_I \quad (15.5-13)$$

$$T_R = 0.4T_I \quad (15.5-14)$$

15.5.2.8 Residual mode seismic response coefficient. The residual mode seismic response coefficient, C_{SR} , shall be determined in accordance with the following equation:

$$C_{SR} = \left(\frac{R}{C_d} \right) \frac{S_{DS}}{\Omega_0 B_R} \quad (15.5-15)$$

where:

- B_R = Numerical coefficient as set forth in Table 15.6-1 for effective damping equal to β_R , and period of the structure equal to T_R .

15.5.2.9 Design lateral force. The design lateral force in elements of the seismic-force-resisting system at Level i due to fundamental mode response, F_{iI} , and residual mode response, F_{iR} , of the structure in the direction of interest shall be determined in accordance with Eq. 15.5-16 and 15.5-17 as follows:

$$F_{iI} = w_i \phi_{iI} \frac{\Gamma_I}{\bar{W}_I} V_I \quad (15.5-16)$$

$$F_{iR} = w_i \phi_{iR} \frac{\Gamma_R}{\bar{W}_R} V_R \quad (15.5-17)$$

Design forces in elements of the seismic-force-resisting system shall be determined by taking the square root of the sum of the squares of the forces due to fundamental and residual modes.

15.5.3 Damping system. Design forces in damping devices and other elements of the damping system shall be determined on the basis of the floor deflection, story drift, and story velocity response parameters described in the following sections.

Displacements and velocities used to determine maximum forces in damping devices at each story shall account for the angle of orientation from horizontal and consider the effects of increased response due to torsion required for design of the seismic-force-resisting system.

Floor deflections at Level i , δ_{iD} and δ_{iM} , design story drifts, Δ_D and Δ_M , and design story velocities, ∇_D and ∇_M , shall be calculated for both the design earthquake and the maximum considered earthquake, respectively, in accordance with the following sections.

15.5.3.1 Design earthquake floor deflection. The total design earthquake deflection at each floor of the structure in the direction of interest shall be calculated as the square root of the sum of the squares of the fundamental and residual mode floor deflections. The fundamental and residual mode deflections due to the design earthquake, δ_{iID} and δ_{iRD} , at the center of rigidity of Level i of the structure in the direction of interest shall be determined using Eq. 15.5-18 and 15.5-19 as follows:

$$\delta_{iID} = D_{iD} \phi_{iI} \quad (15.5-18)$$

$$\delta_{iRD} = D_{iRD} \phi_{iR} \quad (15.5-19)$$

where:

D_{iD} = Fundamental mode design displacement at the center of rigidity of the roof level of the structure in the direction under consideration, Sec. 15.5.3.2.

D_{iRD} = Residual mode design displacement at the center of rigidity of the roof level of the structure in the direction under consideration, Sec. 15.5.3.2.

15.5.3.2 Design earthquake roof displacement. Fundamental and residual mode displacements due to the design earthquake, D_{iD} and D_{iR} , at the center of rigidity of the roof level of the structure in the direction of interest shall be determined using Eq. 15.5-20 and 15.5-21 as follows:

$$D_{iD} = \left(\frac{g}{4\pi^2} \right) \Gamma_1 \frac{S_{DS} T_{iD}^2}{B_{iD}} \geq \left(\frac{g}{4\pi^2} \right) \Gamma_1 \frac{S_{DS} T_1^2}{B_{1E}}, \quad T_{iD} < T_s \quad (15.5-20a)$$

$$D_{iD} = \left(\frac{g}{4\pi^2} \right) \Gamma_1 \frac{S_{D1} T_{iD}}{B_{iD}} \geq \left(\frac{g}{4\pi^2} \right) \Gamma_1 \frac{S_{D1} T_1}{B_{1E}}, \quad T_{iD} \geq T_s \quad (15.5-20b)$$

$$D_{iRD} = \left(\frac{g}{4\pi^2} \right) \Gamma_R \frac{S_{D1} T_{iR}}{B_R} \leq \left(\frac{g}{4\pi^2} \right) \Gamma_R \frac{S_{DS} T_R^2}{B_R}$$

15.5.3.3 Design earthquake story drift. Design earthquake story drifts, Δ_D , in the direction of interest shall be calculated using Eq. 15.5-22 as follows:

$$\Delta_D = \sqrt{\Delta_{ID}^2 + \Delta_{RD}^2} \quad (15.5-22)$$

where:

Δ_{ID} = design earthquake story drift due to the fundamental mode of vibration of the structure in the direction of interest, and

Δ_{RD} = design earthquake story drift due to the residual mode of vibration of the structure in the direction of interest.

Modal design earthquake story drifts, Δ_{ID} and Δ_{RD} , shall be determined in accordance with Eq. 5.3-8 using the floor deflections of Sec. 15.5.3.1

15.5.3.4 Design earthquake story velocity. Design earthquake story velocities, ∇_D , in the direction of interest shall be calculated in accordance with Eq. 15.5-23 through 15.5-25 as follows:

$$\nabla_D = \sqrt{\nabla_{ID}^2 + \nabla_{RD}^2} \quad (15.5-23)$$

$$\nabla_{ID} = 2\pi \frac{\Delta_{ID}}{T_{ID}} \quad (15.5-24)$$

$$\nabla_{RD} = 2\pi \frac{\Delta_{RD}}{T_R} \quad (15.5-25)$$

where:

∇_{ID} = design earthquake story velocity due to the fundamental mode of vibration of the structure in the direction of interest, and

∇_{RD} = design earthquake story velocity due to the residual mode of vibration of the structure in the direction of interest.

15.5.3.5 Maximum earthquake response. Total and modal maximum earthquake floor deflections at Level i , design story drifts, and design story velocities shall be based on the equations in Sec. 15.5.3.1, 15.5.3.3 and 15.5.3.4, respectively, except that design earthquake roof displacements shall be replaced by maximum earthquake roof displacements. Maximum earthquake roof displacements shall be calculated in accordance with Eq. 15.5-26 and 15.5-27 as follows:

$$D_{1M} = \left(\frac{g}{4\pi^2} \right) \Gamma_1 \frac{S_{MS} T_{1M}^2}{B_{1M}} \geq \left(\frac{g}{4\pi^2} \right) \Gamma_1 \frac{S_{MS} T_1^2}{B_{1E}}, \quad T_{1M} < T_S \quad (15.5-26a)$$

$$D_{1M} = \left(\frac{g}{4\pi^2} \right) \Gamma_1 \frac{S_{M1} T_{1M}}{B_{1M}} \geq \left(\frac{g}{4\pi^2} \right) \Gamma_1 \frac{S_{M1} T_1}{B_{1E}}, \quad T_{1M} \geq T_S \quad (15.5-26b)$$

$$D_{RM} = \left(\frac{g}{4\pi^2} \right) \Gamma_R \frac{S_{M1} T_R}{B_R} \leq \left(\frac{g}{4\pi^2} \right) \Gamma_R \frac{S_{MS} T_R^2}{B_R} \quad (15.5-27)$$

where:

- S_{MI} = the maximum considered earthquake, 5-percent-damped, spectral response acceleration at a period of 1 second, determined in accordance with Chapter 3.
- S_{MS} = the maximum considered earthquake, 5-percent-damped, spectral response acceleration at short periods, determined in accordance with Chapter 3.
- B_{IM} = Numerical coefficient as set forth in Table 15.6-1 for effective damping equal to β_{mM} ($m = 1$) and period of structure equal to T_{IM} .

15.6 DAMPED RESPONSE MODIFICATION

As required in Sec. 15.4 and 15.5, response of the structure shall be modified for the effects of the damping system.

15.6.1 Damping coefficient. Where the period of the structure is greater than or equal to T_0 , the damping coefficient shall be as prescribed in Table 15.6-1. Where the period of the structure is less than T_0 , the damping coefficient shall be linearly interpolated between a value of 1.0 at a 0-second period for all values of effective damping and the value at period T_0 as indicated in Table 15.6-1.

Table 15.6-1
Damping Coefficient, B_{V+I} , B_{ID} , B_R , B_{IM} , B_{mD} , or B_{mM}

Effective Damping, β (percentage of critical)	B_{V+I} , B_{ID} , B_R , B_{IM} , B_{mD} or B_{mM} (where period of the structure $\leq T_0$)
≤ 2	0.8
5	1.0
10	1.2
20	1.5
30	1.8
40	2.1
50	2.4
60	2.7
70	3.0
80	3.3
90	3.6
≤ 100	4.0

15.6.2 Effective damping. The effective damping at the design displacement, β_{mD} , and at the maximum displacement, β_{mM} , of the m^{th} mode of vibration of the structure in the direction under consideration shall be calculated using Eq. 15.6-1 and 15.6-2 as follows:

$$\beta_{mD} = \beta_I + \beta_{Vm} \sqrt{\mu_D} + \beta_{HD} \quad (15.6-1)$$

$$\beta_{mM} = \beta_I + \beta_{Vm} \sqrt{\mu_M} + \beta_{HM} \quad (15.6-2)$$

where:

- β_{HD} = component of effective damping of the structure in the direction of interest due to post-yield hysteretic behavior of the seismic-force-resisting system and elements of the damping system at effective ductility demand, μ_D ;

- β_{HM} = component of effective damping of the structure in the direction of interest due to post-yield hysteretic behavior of the seismic-force-resisting system and elements of the damping system at effective ductility demand, μ_M ;
- β_I = component of effective damping of the structure due to the inherent dissipation of energy by elements of the structure, at or just below the effective yield displacement of the seismic-force-resisting system;
- β_{vm} = component of effective damping of the m^{th} mode of vibration of the structure in the direction of interest due to viscous dissipation of energy by the damping system, at or just below the effective yield displacement of the seismic-force-resisting system;
- μ_D = effective ductility demand on the seismic-force-resisting system in the direction of interest due to the design earthquake; and
- μ_M = effective ductility demand on the seismic-force-resisting system in the direction of interest due to the maximum considered earthquake.

Unless analysis or test data supports other values, the effective ductility demand of higher modes of vibration in the direction of interest shall be taken as 1.0.

15.6.2.1 Inherent damping. Inherent damping, β_I , shall be based on the material type, configuration, and behavior of the structure and nonstructural components responding dynamically at or just below yield of the seismic-force-resisting system. Unless analysis or test data supports other values, inherent damping shall be taken as not greater than five percent of critical for all modes of vibration.

15.6.2.2 Hysteretic damping. Hysteretic damping of the seismic-force-resisting system and elements of the damping system shall be based either on test or analysis, or shall be calculated using Eq. 15.6-3 and 15.6-4 as follows:

$$\beta_{HD} = q_H (0.64 - \beta_I) \left(1 - \frac{1}{\mu_D} \right) \quad (15.6-3)$$

$$\beta_{HM} = q_H (0.64 - \beta_I) \left(1 - \frac{1}{\mu_M} \right) \quad (15.6-4)$$

where:

- q_H = hysteresis loop adjustment factor, as defined in Sec. 15.6.2.2.1,
- μ_D = effective ductility demand on the seismic-force-resisting system in the direction of interest due to the design earthquake, as defined in Sec. 15.6.3, and
- μ_M = effective ductility demand on the seismic-force-resisting system in the direction of interest due to the maximum considered earthquake, as defined in Sec. 15.6.3.

Unless analysis or test data supports other values, the hysteretic damping of higher modes of vibration in the direction of interest shall be taken as zero.

15.6.2.2.1 Hysteresis loop adjustment factor. The calculation of hysteretic damping of the seismic-force-resisting system and elements of the damping system shall consider pinching and other effects that reduce the area of the hysteresis loop during repeated cycles of earthquake demand. Unless analysis or test data support other values, the fraction of full hysteretic loop area of the seismic-force-resisting system used for design shall be taken as equal to the factor, q_H , using Eq. 15.6-5 as follows:

$$q_H = 0.67 \frac{T_S}{T_I} \quad (15.6-5)$$

where:

- T_S = period defined by the ratio, S_{D1}/S_{D5}

T_1 = period of the fundamental mode of vibration of the structure in the direction of the interest

The value of q_H shall not be taken as greater than 1.0, and need not be taken as less than 0.5.

15.6.2.3 Viscous damping. Viscous damping of the m^{th} mode of vibration of the structure, β_{vm} , shall be calculated using Eq. 15.6-6 and 15.6-7 as follows:

$$\beta_{vm} = \frac{\sum_j W_{mj}}{4\pi W_m} \quad (15.6-6)$$

$$W_m = \frac{1}{2} \sum_i F_{im} \delta_{im} \quad (15.6-7)$$

where:

W_{mj} = work done by j^{th} damping device in one complete cycle of dynamic response corresponding to the m^{th} mode of vibration of the structure in the direction of interest at modal displacements, δ_{im} ,

W_m = maximum strain energy in the m^{th} mode of vibration of the structure in the direction of interest at modal displacements, δ_{im} ,

F_{im} = m^{th} mode inertial force at Level i ,

δ_{im} = deflection of Level i in the m^{th} mode of vibration at the center of rigidity of the structure in the direction under consideration.

Viscous modal damping of displacement-dependent damping devices shall be based on a response amplitude equal to the effective yield displacement of the structure.

The calculation of the work done by individual damping devices shall consider orientation and participation of each device with respect to the mode of vibration of interest. The work done by individual damping devices shall be reduced as required to account for the flexibility of elements, including pins, bolts, gusset plates, brace extensions, and other components that connect damping devices to other elements of the structure.

15.6.3 Effective ductility demand. The effective ductility demand on the seismic-force-resisting system due to the design earthquake, μ_D , and due to the maximum considered earthquake, μ_M , shall be calculated using Eq. 15.6-8, 15.6-9, and 15.6-10 as follows:

$$\mu_D = \frac{D_{1D}}{D_Y} \geq 1.0 \quad (15.6-8)$$

$$\mu_M = \frac{D_{1M}}{D_Y} \geq 1.0 \quad (15.6-9)$$

$$D_Y = \left(\frac{g}{4\pi^2} \right) \left(\frac{\Omega_0 C_d}{R} \right) \Gamma_1 C_{s1} T_1^2 \quad (15.6-10)$$

where:

D_{1D} = fundamental mode design displacement at the center of rigidity of the roof level of the structure in the direction under consideration, Sec. 15.5.3.2,

D_{1M} = fundamental mode maximum displacement at the center of rigidity of the roof level of structure in the direction under consideration, Sec. 15.5.3.5,

D_Y = displacement at the center of rigidity of the roof level of the structure at the effective yield point of the seismic-force-resisting system,

R = response modification factor from Table 4.3-1,

- C_d = deflection amplification factor from Table 4.3-1,
 Ω_0 = system overstrength factor from Table 4.3-1,
 Γ_1 = participation factor of the fundamental mode of vibration of the structure in the direction of interest, Sec. 15.4.2.3 or Sec. 15.5.2.3 ($m = 1$),
 C_{S1} = seismic response coefficient of the fundamental mode of vibration of the structure in the direction of interest, Sec. 15.4.2.4 or Sec. 15.5.2.4 ($m = 1$), and
 T_1 = period of the fundamental mode of vibration of the structure in the direction of interest.

The design earthquake ductility demand, μ_D , shall not exceed the maximum value of effective ductility demand, μ_{max} , given in Sec. 15.6.4.

15.6.4 Maximum effective ductility demand. For determination of the hysteresis loop adjustment factor, hysteretic damping, and other parameters, the maximum value of effective ductility demand, μ_{max} , shall be calculated using Eq. 15.6-11 and 15.6-12 as follows:

$$\text{For } T_{1D} \leq T_S, \mu_{max} = \frac{1}{2} \left(\left(\frac{R}{\Omega_0 I} \right)^2 + 1 \right) \quad (15.6-11)$$

$$\text{For } T_1 \geq T_S, \mu_{max} = \frac{R}{\Omega_0 I} \quad (15.6-12)$$

For $T_1 < T_S < T_{1D}$, μ_{max} shall be determined by linear interpolation between the values of Eq. 15.6-11 and 15.6-12

where:

- I = the occupancy importance factor determined in accordance with Sec. 1.3.
 T_{1D} = effective period of the fundamental mode of vibration of the structure at the design displacement in the direction under consideration.

15.7 SEISMIC LOAD CONDITIONS AND ACCEPTANCE CRITERIA

For the nonlinear procedures of Sec. 15.3, the seismic-force-resisting system, damping system, loading conditions and acceptance criteria for response parameters of interest shall conform with Sec. 15.7.1. Design forces and displacements determined in accordance with the response spectrum procedure of Sec. 15.4 or the equivalent lateral force procedure of Sec. 15.5 shall be checked using the strength design criteria of the *Provisions* and the seismic loading conditions of Sec. 15.7.2 and 15.7.3.

15.7.1 Nonlinear procedures. Where nonlinear procedures are used in analysis, the seismic force resisting system, damping system, seismic loading conditions and acceptance criteria shall conform to the following subsections.

15.7.1.1 Seismic force resisting system. The seismic-force-resisting system shall satisfy the strength requirements of Sec. 4.3 using the seismic base shear, V_{min} , as given by Sec. 15.2.2.1.

15.7.1.2 Seismic loads. Seismic forces shall be based upon the design earthquake for damping system strength. The damping devices and their connections shall be sized to resist the forces, displacements and velocities from the maximum considered earthquake. The story drift shall be determined using the design earthquake.

15.7.1.3 Combination of load effects. The effects on the damping system due to gravity loads and seismic forces shall be combined in accordance with Sec. 4.2.2 using the effect of horizontal seismic forces, Q_E , determined in accordance with the analysis. The redundancy factor, ρ , shall be taken equal to 1.0 in all cases and the seismic load effect with overstrength of Sec. 4.2.2.2 need not apply to the design of the damping system.

15.7.1.4 Acceptance criteria for the response parameters of interest. The damping system components shall be evaluated using the strength design criteria of the *Provisions* using the seismic forces and seismic loading conditions determined from the nonlinear procedures and $\phi = 1.0$. The members of the seismic-force-resisting system need not be evaluated when using the nonlinear procedure forces.

The story drift shall not exceed 125 percent of the allowable story drift, Δ_a , as obtained from Table 4.5-1. The maximum story drift shall include torsional effects.

15.7.2 Seismic-force-resisting system. The seismic-force-resisting system shall satisfy the requirements of Sec. 4.3 using seismic base shear and design forces determined in accordance with Sec. 15.4.2 or Sec. 15.5.2.

The design earthquake story drift, Δ_D , as determined in either Sec. 15.4.3.3 or Sec. 15.5.3.3 shall not exceed (R/C_d) times the allowable story drift, as obtained from Table 4.5-1, considering the effects of torsion as required in Sec. 4.5.1.

15.7.3 Damping system. The damping system shall satisfy the requirements of Sec. 4.3 for seismic design forces and seismic loading conditions determined in accordance with this section.

15.7.3.1 Combination of load effects. The effects on the damping system and its components due to gravity loads and seismic forces shall be combined in accordance with Sec. 4.2.2 using the effect of horizontal seismic forces, Q_E , determined in accordance with Sec. 15.7.3.3. The redundancy factor, ρ , shall be taken equal to 1.0 in all cases and the seismic load effect with overstrength of Sec. 4.2.2.2 need not apply to the design of the damping system.

15.7.3.2 Modal damping system design forces. Modal damping system design forces shall be calculated on the basis of the type of damping devices and the modal design story displacements and velocities determined in accordance with either Sec. 15.4.3 or Sec. 15.5.3.

Modal design story displacements and velocities shall be increased as required to envelop the total design story displacements and velocities determined in accordance with Sec. 15.3 where peak response is required to be confirmed by time history analysis.

1. Displacement-Dependent Damping Devices: Design seismic force in displacement-dependent damping devices shall be based on the maximum force in the device at displacements up to and including the design earthquake story drift, Δ_D .
2. Velocity-Dependent Damping Devices: Design seismic force in each mode of vibration of velocity-dependent damping devices shall be based on the maximum force in the device at velocities up to and including the design earthquake story velocity for the mode of interest.

Displacements and velocities used to determine design forces in damping devices at each story shall account for the angle of orientation from horizontal and consider the effects of increased floor response due to torsional motions.

15.7.3.3 Seismic load conditions and combination of modal responses. Seismic design force, Q_E , in each element of the damping system due to horizontal earthquake load shall be taken as the maximum force of the following three loading conditions:

1. Stage of Maximum Displacement: Seismic design force at the stage of maximum displacement shall be calculated in accordance with Eq. 15.7-1 as follows:

$$Q_E = \Omega_o \sqrt{\sum_m (Q_{mSFERS})^2} \pm Q_{DSD} \quad (15.7-1)$$

where:

$$Q_{mSFERS} = \text{Force in an element of the damping system equal to the design seismic force of the } m^{\text{th}} \text{ mode of vibration of the seismic-force-resisting system in the direction of interest.}$$

Q_{DSD} = Force in an element of the damping system required to resist design seismic forces of displacement-dependent damping devices.

Seismic forces in elements of the damping system, Q_{DSD} , shall be calculated by imposing design forces of displacement-dependent damping devices on the damping system as pseudo-static forces. Design seismic forces of displacement-dependent damping devices shall be applied in both positive and negative directions at peak displacement of the structure.

2. Stage of Maximum Velocity: Seismic design force at the stage of maximum velocity shall be calculated in accordance with Eq. 15.7-2 as follows:

$$Q_E = \sqrt{\sum_m (Q_{mDSV})^2} \quad (15.7-2)$$

where:

Q_{mDSV} = Force in an element of the damping system required to resist design seismic forces of velocity-dependent damping devices due to the m^{th} mode of vibration of structure in the direction of interest.

Modal seismic design forces in elements of the damping system, Q_{mDSV} , shall be calculated by imposing modal design forces of velocity-dependent devices on the non-deformed damping system as pseudo-static forces. Modal seismic design forces shall be applied in directions consistent with the deformed shape of the mode of interest. Horizontal restraint forces shall be applied at each floor Level i of the non-deformed damping system concurrent with the design forces in velocity-dependent damping devices such that the horizontal displacement at each level of the structure is zero. At each floor Level i , restraint forces shall be proportional to and applied at the location of each mass point.

3. Stage of Maximum Acceleration: Seismic design force at the stage of maximum acceleration shall be calculated in accordance Eq. 15.7-3 as follows:

$$Q_E = \sqrt{\sum_m (C_{mFD} \Omega_o Q_{mSFRS} + C_{mFV} Q_{mDSV})^2} \pm Q_{DSD} \quad (15.7-3)$$

The force coefficients, C_{mFD} and C_{mFV} , shall be determined from Tables 15.7-1 and 15.7-2, respectively, using values of effective damping determined in accordance with the following requirements:

For fundamental-mode response ($m = 1$) in the direction of interest, the coefficients, C_{IFD} and C_{IFV} , shall be based on the velocity exponent, α , that relates device force to damping device velocity. The effective fundamental-mode damping, shall be taken equal to the total effective damping of the fundamental mode less the hysteretic component of damping ($\beta_{1D} - \beta_{HD}$ or $\beta_{1M} - \beta_{HM}$) at the response level of interest ($\mu = \mu_D$ or $\mu = \mu_M$).

For higher-mode ($m > 1$) or residual-mode response in the direction of interest, the coefficients, C_{mFD} and C_{mFV} , shall be based on a value of α equal to 1.0. The effective modal damping shall be taken equal to the total effective damping of the mode of interest (β_{mD} or β_{mM}). For determination of the coefficient C_{mFD} , the ductility demand shall be taken equal to that of the fundamental mode ($\mu = \mu_D$ or $\mu = \mu_M$).

Table 15.7-1 Force Coefficient, C_{mFD} ^{a, b}

Effective Damping	$\mu \leq 1.0$				$C_{mFD} = 1.0^c$
	$\alpha \leq 0.25$	$\alpha = 0.5$	$\alpha = 0.75$	$\alpha \geq 1.0$	
≤ 0.05	1.00	1.00	1.00	1.00	$\mu \geq 1.0$
0.1	1.00	1.00	1.00	1.00	$\mu \geq 1.0$
0.2	1.00	0.95	0.94	0.93	$\mu \geq 1.1$
0.3	1.00	0.92	0.88	0.86	$\mu \geq 1.2$
0.4	1.00	0.88	0.81	0.78	$\mu \geq 1.3$
0.5	1.00	0.84	0.73	0.71	$\mu \geq 1.4$
0.6	1.00	0.79	0.64	0.64	$\mu \geq 1.6$
0.7	1.00	0.75	0.55	0.58	$\mu \geq 1.7$
0.8	1.00	0.70	0.50	0.53	$\mu \geq 1.9$
0.9	1.00	0.66	0.50	0.50	$\mu \geq 2.1$
≥ 1.0	1.00	0.62	0.50	0.50	$\mu \geq 2.2$

^a Unless analysis or test data support other values, the force coefficient C_{mFD} for visco-elastic systems shall be taken as 1.0.

^b Interpolation shall be used for intermediate values of velocity exponent α , and ductility demand, μ .

^c C_{mFD} shall be taken equal to 1.0 for values of ductility demand, μ , greater than or equal to the values shown.

Table 15.7-2 Force Coefficient, C_{mFV} ^{a, b}

Effective Damping	$\alpha \leq 0.25$	$\alpha = 0.5$	$\alpha = 0.75$	$\alpha \geq 1.0$
≤ 0.05	1.00	0.35	0.20	0.10
0.1	1.00	0.44	0.31	0.20
0.2	1.00	0.56	0.46	0.37
0.3	1.00	0.64	0.58	0.51
0.4	1.00	0.70	0.69	0.62
0.5	1.00	0.75	0.77	0.71
0.6	1.00	0.80	0.84	0.77
0.7	1.00	0.83	0.90	0.81
0.8	1.00	0.90	0.94	0.90
0.9	1.00	1.00	1.00	1.00
≥ 1.0	1.00	1.00	1.00	1.00

^a Unless analysis or test data support other values, the force coefficient C_{mFD} for visco-elastic systems shall be taken as 1.0.

^b Interpolation shall be used for intermediate values of velocity exponent, α .

15.7.3.4 Inelastic response limits. Elements of the damping system may exceed strength limits for design loads provided it is shown by analysis or test that:

1. Inelastic response does not adversely affect damping system function.
2. Element forces calculated in accordance with Sec. 15.7.3.3, using a value of Ω_0 , taken equal to 1.0, do not exceed the strength required to satisfy the load combinations of Sec. 4.2.2.1.

15.8 DESIGN REVIEW

A design review of the damping system and related test programs shall be performed by an independent team of registered design professionals in the appropriate disciplines and others experienced in seismic analysis methods and the theory of energy dissipation systems.

The design review shall include, but need not be limited to, the following:

1. Review of site-specific seismic criteria including the development of the site-specific spectra and ground motion histories and all other design criteria developed specifically for the project;
2. Review of the preliminary design of the seismic-force-resisting system and the damping system, including design parameters of damping devices;
3. Review of the final design of the seismic-force-resisting system and the damping system and all supporting analyses; and
4. Review of damping device test requirements, device manufacturing quality control and assurance, and scheduled maintenance and inspection requirements.

15.9 TESTING

The force-velocity-displacement and damping properties used for the design of the damping system shall be based on the prototype tests as specified in this section.

The fabrication and quality control procedures used for all prototype and production damping devices shall be identical.

15.9.1 Prototype tests

The following tests shall be performed separately on two full-size damping devices of each type and size used in the design, in the order listed below.

Representative sizes of each type of device may be used for prototype testing, provided both of the following conditions are met:

1. All pertinent testing and other damping device data are made available to, and are accepted by the registered design professional responsible for the design of the structure.
2. The registered design professional substantiates the similarity of the damping device to previously tested devices.

Test specimens shall not be used for construction, unless they are accepted by the registered design professional responsible for design of the structure and meet the requirements for prototype and production tests.

15.9.1.1 Data recording. The force-deflection relationship for each cycle of each test shall be recorded.

15.9.1.2 Sequence and cycles of testing. For the following test sequences, each damping device shall be subjected to gravity load effects and thermal environments representative of the installed condition. For seismic testing, the displacement in the devices calculated for the maximum considered earthquake, termed herein as the maximum earthquake device displacement, shall be used.

1. Each damping device shall be subjected to the number of cycles expected in the design windstorm, but not less than 2000 continuous fully reversed cycles of wind load. Wind load shall be at

amplitudes expected in the design wind storm, and applied at a frequency equal to the inverse of the fundamental period of the building ($f_l = 1/T_l$).

Exception: Damping devices need not be subjected to these tests if they are not subject to wind-induced forces or displacements, or if the design wind force is less than the device yield or slip force.

2. Each damping device shall be loaded with 5 fully reversed, sinusoidal cycles at the maximum earthquake device displacement at a frequency equal to $1/T_{IM}$ as calculated in Sec. 15.4.2.5. Where the damping device characteristics vary with operating temperature, these tests shall be conducted at a minimum of 3 temperatures (minimum, ambient, and maximum) that bracket the range of operating temperatures.

Exception: Damping devices may be tested by alternative methods provided all of the following conditions are met:

- a. Alternative methods of testing are equivalent to the cyclic testing requirements of this section.
 - b. Alternative methods capture the dependence of the damping device response on ambient temperature, frequency of loading, and temperature rise during testing.
 - c. Alternative methods are accepted by the registered design professional responsible for the design of the structure.
3. If the force-deformation properties of the damping device at any displacement less than or equal to the maximum earthquake device displacement change by more than 15 percent for changes in testing frequency from $1/T_{IM}$ to $2.5/T_l$, then the preceding tests shall also be performed at frequencies equal to $1/T_l$ and $2.5/T_l$.

If reduced-scale prototypes are used to qualify the rate dependent properties of damping devices, the reduced-scale prototypes should be of the same type and materials, and manufactured with the same processes and quality control procedures, as full-scale prototypes, and tested at a similitude-scaled frequency that represents the full-scale loading rates.

15.9.1.3 Testing similar devices. Damping devices need not be prototype tested provided that both of the following conditions are met:

1. All pertinent testing and other damping device data are made available to, and are accepted by the registered design professional responsible for the design of the structure.
2. The registered design professional substantiates the similarity of the damping device to previously tested devices.

15.9.1.4 Determination of force-velocity-displacement characteristics. The force-velocity-displacement characteristics of a damping device shall be based on the cyclic load and displacement tests of prototype devices specified above. Effective stiffness of a damping device shall be calculated for each cycle of deformation using equation 13.6-1.

15.9.1.5 Device adequacy. The performance of a prototype damping device shall be deemed adequate if all of the conditions listed below are satisfied. The 15-percent limits specified below may be increased by the registered design professional responsible for the design of the structure provided that the increased limit has been demonstrated by analysis not to have a deleterious effect on the response of the structure.

15.9.1.5.1 Displacement-dependent damping devices. The performance of the prototype displacement-dependent damping devices shall be deemed adequate if the following conditions, based on tests specified in Sec. 15.9.1.2, are satisfied:

1. For Test 1, no signs of damage including leakage, yielding, or breakage.
2. For Tests 2 and 3, the maximum force and minimum force at zero displacement for a damping device for any one cycle does not differ by more than 15 percent from the average maximum and minimum forces at zero displacement as calculated from all cycles in that test at a specific frequency and temperature.
3. For Tests 2 and 3, the maximum force and minimum force at maximum earthquake device displacement for a damping device for any one cycle does not differ by more than 15 percent from the average maximum and minimum forces at the maximum earthquake device displacement as calculated from all cycles in that test at a specific frequency and temperature.
4. For Tests 2 and 3, the area of hysteresis loop (E_{loop}) of a damping device for any one cycle does not differ by more than 15 percent from the average area of the hysteresis loop as calculated from all cycles in that test at a specific frequency and temperature.
5. The average maximum and minimum forces at zero displacement and maximum earthquake displacement, and the average area of the hysteresis loop (E_{loop}), calculated for each test in the sequence of Tests 2 and 3, shall not differ by more than 15 percent from the target values specified by the registered design professional responsible for the design of the structure.

15.9.1.5.1 Velocity-dependent damping devices. The performance of the prototype velocity-dependent damping devices shall be deemed adequate if the following conditions, based on tests specified in Sec. 15.9.1.2, are satisfied:

1. For Test 1, no signs of damage including leakage, yielding, or breakage.
2. For velocity-dependent damping devices with stiffness, the effective stiffness of a damping device in any one cycle of Tests 2 and 3 does not differ by more than 15 percent from the average effective stiffness as calculated from all cycles in that test at a specific frequency and temperature.
3. For Tests 2 and 3, the maximum force and minimum force at zero displacement for a damping device for any one cycle does not differ by more than 15 percent from the average maximum and minimum forces at zero displacement as calculated from all cycles in that test at a specific frequency and temperature.
4. For Tests 2 and 3, the area of hysteresis loop (E_{loop}) of a damping device for any one cycle does not differ by more than 15 percent from the average area of the hysteresis loop as calculated from all cycles in that test at a specific frequency and temperature.
5. The average maximum and minimum forces at zero displacement, effective stiffness (for damping devices with stiffness only), and average area of the hysteresis loop (E_{loop}) calculated for each test in the sequence of Tests 2 and 3, does not differ by more than 15 percent from the target values specified by the registered design professional responsible for the design of the structure.

15.9.2 Production testing. Prior to installation in a building, damping devices shall be tested to ensure that their force-velocity-displacement characteristics fall within the limits set by the registered design professional responsible for the design of the structure. The scope and frequency of the production-testing program shall be determined by the registered design professional responsible for the design of the structure.

Appendix A

DIFFERENCES BETWEEN THE 2000 AND THE 2003 EDITIONS OF THE *NEHRP RECOMMENDED PROVISIONS*

EDITORIAL AND ORGANIZATIONAL CHANGES

The 2003 *Provisions* and *Commentary* documents were developed in two phases. First, the 2000 Edition was thoroughly edited and reformatted to increase the usability of the documents and eliminate inconsistencies that had crept in over the years. This reformatted version was approved by the BSSC member organizations and became the base document used in the remainder of the update process. The marked up version of the 2000 *Provisions* contents presented at the end of this appendix shows the reformatting organizational changes made as well as those resulting from substantive proposals for change.

The 2003 PUC also worked closely with those developing the seismic requirements for ASCE 7. The goal was to begin to reduce the redundancy between the *Provisions* and ASCE 7. The longer term goal, which should be achieved as a result of the next *Provisions* update, is to fully integrate ASCE 7 as a reference standard in the *Provisions* and thereby eliminate duplications.

2003 CHAPTER 1, GENERAL PROVISIONS

The manner in which Seismic Design Category is determined in Sec. 1.4.1 has been clarified by the addition of an exception. Note that the Simplified Alternate Chapter 4 includes an explanation of how to determine SDC using that procedure.

Section 1.5.3 has been modified to replace the term “anchor” with the term “connector.” This section also has been broadened to apply to more than just the interface of walls to roofs or floors.

2003 CHAPTER 2, QUALITY ASSURANCE

The quality assurance requirements that appeared as Chapter 2 of the 2000 *Provisions* now appear as Chapter 3. Definitions have been added for “quality assurance,” “quality assurance plan,” and “quality control.”

2003 CHAPTER 3, GROUND MOTION

One of the most significant changes made for the 2003 edition affects the ground motion requirements. First, the spectral acceleration maps distributed in a separate packet with past editions now are reduced in number and size and appear in the 2003 *Provisions* volume. Further, the maps are based on the newest version of the U.S. Geological Survey’s hazard maps and long-period maps showing contours for up to a 16-sec period have been added to permit designers to take longer period, T_L , into account.

The site classification procedures have been clarified and commentary has been added on site class definitions and on the procedure used to classify a site (Sec. 3.5.1 and 3.5.2).

Provisions Sec. 3.4 has been revised to strengthen and make more explicit the requirements for site-specific determinations of earthquake ground motions and new text to support this section has been added to the *Commentary*.

2003 CHAPTER 4, STRUCTURAL DESIGN CRITERIA

The redundancy provisions have been substantially revised for the 2003 *Provisions* to both simplify the calculation effort and to provide provisions that result in requirements that are more consistent with observed performance. Some minor modifications were made to the *R* factor table to provide for more consistency with respect to nonductile systems and dual systems. The base shear equations have been modified to take into account the new long-period ground motion maps, to adjust the minimum base shear value, and to refine the requirements for when the near-source equations are to be used. The *P*-delta and nonlinear static pushover analysis requirements have been modified to take into account recent research results.

An alternate chapter has been prepared to provide simplified design procedures for a specific class of structure. Low-rise buildings that are regular in plan and consist of “rigid” vertical seismic force-resisting systems may be designed using this alternative procedure, which significantly simplifies the design process.

2003 CHAPTER 5, STRUCTURAL ANALYSIS PROCEDURE

Revisions were made to Sec. 5.6 to clarify that the provisions of this section to determine soil-structure-interaction effects on design earthquake forces and displacements should not be used if foundation springs are incorporated in the analysis to directly model soil-structure interaction effects.

2003 CHAPTER 6, ARCHITECTURAL, MECHANICAL, AND ELECTRICAL COMPONENTS

The provisions for anchorage have been modified to reflect the current state of practice. New requirements for fire sprinkler system bracing and a new performance-based design approach for piping have been added for the 2003 edition. Also added are design provisions for long-period components. Requirements for suspended components have been updated and requirements concerning direction of loading have been clarified.

2003 CHAPTER 7, FOUNDATION DESIGN REQUIREMENTS

New in the 2003 edition are provisions and commentary covering the geotechnical ultimate strength design of foundations as a proposed replacement for allowable stress design. These procedures appear as an appendix to Chapter 7 to provide for trial use and evaluation prior to incorporation in the main text of the *Provisions*.

Also new in the 2003 edition are provisions and commentary concerning the modeling of the load-deformation characteristics of the foundation-soil system (“foundation stiffness”) using soil springs. Linear springs are addressed in the main text of the *Provisions* whereas nonlinear springs are treated in an appendix.

Supplemental provisions and commentary have been added for minimum longitudinal reinforcement requirements for uncased concrete piles, piles in a group containing both batter and vertical piles, and steel H piles.

The provisions mandating assessments of seismically induced geohazards in Seismic Design Categories (SDC) C, D, E, and F have been modified to waive these requirements when the authority having jurisdiction determines that sufficient information is available for nearby sites to evaluate the hazard for the proposed construction. Commentary text describing methods for geohazards assessments has been updated and guidance added on hazard screening and determination of earthquake magnitude.

2003 CHAPTER 8, STEEL STRUCTURE DESIGN REQUIREMENTS

Changes made for the 2003 edition include reference to the 2002 edition of the AISC Seismic Provisions and other updated standards.

New provisions and commentary have been added to address buckling restrained braced frames (BRBF). This system, initially developed in Japan and now gaining widespread use in areas of high seismicity in the United States, provides for highly ductile bracing elements in concentrically braced frames. Also included are new provisions and commentary to address special steel plate walls. This system, which has been included in the National Building Code of Canada for a number of years based on research conducted both in the United States and Canada, is gaining some limited use in areas of high seismicity in the United States. The system provides for ductile thin steel plate wall elements.

Table 4.3-1 has been updated to better define the requirements for the design of steel intermediate moment, ordinary moment, and ordinary concentrically braced frame systems.

2003 CHAPTER 9, CONCRETE STRUCTURE DESIGN REQUIREMENTS

Adoption of ACI 318-02 has permitted the elimination of many of the definitions and notations that were included in the 2000 *Provisions* as well as the deletion of provisions related to precast gravity load systems, emulation design of seismic-force-resisting precast frame and wall systems, non-emulative design of special moment frames constructed using precast concrete, precast concrete connections, anchor bolts in the top of columns, and most of the provisions related to anchoring to concrete.

Since ACI 318-02 includes a new type of seismic-force-resisting system termed an intermediate precast structural wall, R , Ω_o , and C_d values were added for that system as well as for ordinary precast shear wall systems. Intermediate precast shear wall systems are permitted as seismic-force-resisting systems in SDC D, E and F provided the building height does not exceed 40ft. There are no height limitations on that system for SDC B and C. Ordinary precast shear wall systems are allowed as seismic-force-resisting systems in SDC B only. Tilt-up concrete walls are interpreted in accordance with ACI 318 as precast shear walls and provisions are also introduced for wall piers and segments for intermediate precast structural walls that parallel those of the 2000 *Provisions* for wall piers and segments for special structural walls. Wall piers in both special and intermediate walls are required to be designed as columns if their horizontal length to thickness ratio is less than 2.5. Finally, it is specified that special reinforced concrete structural walls can be of either monolithic or precast construction so that the same R , Ω_o , and C_d apply for both types of construction.

New requirements were added for acceptance criteria and the validation testing of special precast structural walls that parallel those of ACI T1.1, *Acceptance Criteria for Moment Frames Based on*

Structural Testing. However, while the latter are applicable to both monolithic and precast frame construction, the new provisions are restricted to precast wall construction only.

2003 CHAPTER 10, STEEL AND CONCRETE STRUCTURE DESIGN REQUIREMENTS

Most of the requirements for composite structures appear in the reference standard, AISC Seismic Part II; thus, Chapter 10 is very brief and lists only modifications to this standard.

2003 CHAPTER 11, MASONRY STRUCTURE DESIGN REQUIREMENTS

Adoption of the 2002 Masonry Society Joint Committee (MSJC) standards, ACI530/ASCE 5/TMS402 and ACI 530.1/ASCE 6/TMS 602 stimulated a complete revision of Chapter 11. Additional changes were made in the reinforcement requirements for special moment frames.

2003 CHAPTER 12, WOOD STRUCTURE DESIGN REQUIREMENTS

In the 2003 *Provisions*, AF&PA's *ASD/LRFD Supplement Special Design Provisions for Wind and Seismic (AF&PA SDPWS)* and *AF&PA/ASCE 16 Load and Resistance Factor Design (LRFD) for Engineered Wood Construction* serve as the primary reference documents for engineered design provisions for wood. Adoption of *AF&PA SDPWS* permitted the deletion of significant portions of Chapter 12 and stimulated the revision of the material that remains.

A reference to the 2003 *International Residential Code* replaces the reference to the 1995 CABO *One- and Two-Family Dwelling Code*. Other basic requirements for conventional construction in Chapter 12 remain unchanged.

The wood design provisions also have been revised to address shear wall design and construction. The intent of the requirements concerning the sizing of hold-down devices has been clarified and extended to foundation shear anchorage. The equation format for calculating perforated shear wall capacity is introduced into the body of the *Provisions* allowing some efficiencies in determination of wall capacity relative to tabulated strength reduction factors. Guidance for shear wall and diaphragm deflection calculations also has been added as had commentary on the effect of framing moisture content on deflection calculations. Additional guidance also is provided to address constructability issues regarding slotted holes in large plate washers.

2003 CHAPTER 13, SEISMICALLY ISOLATED STRUCTURES DESIGN REQUIREMENTS

For the 2003 *Provisions*, provisions for the analysis and design of structures with damping systems move from an appendix to Chapter 13 to a new Chapter 15, "Structures with Damping Systems", and a short commentary is provided. A series of minor modifications to the 2000 text clarify the basic philosophy of the chapter to prevent erroneous calculations.

In Chapter 13 on seismically isolated structures, an exception on isolation systems without sufficient restoring force has been removed so that all isolation systems must have sufficient restoring force. A new requirement calling for variations in seismic isolator material properties due to aging, contamination, environmental exposure, loading rate, scragging and temperature to be considered in

analysis has been added while the requirement concerning the independence of isolation system behavior vis-à-vis application of the equivalent lateral force procedure has been deleted. Related changes have been made in the commentary text.

2003 CHAPTER 14, NONBUILDING STRUCTURE DESIGN REQUIREMENTS

For 2003 a new definition for nonbuilding structures similar to buildings has been added and the design coefficient table has been split into two tables to cover structures similar to buildings and structures not similar to buildings separately.

Table 14.2-2 has been separated into two tables for consistency with the definition. Furthermore, the path to the applicable design and detailing requirements in the other chapters and in Chapter 14 has been added to Tables 14.2-2 and the new Table 14.2-3.

Table 14.2-2 of the 2000 *Provisions* for nonbuilding structures similar to buildings prescribed R , Ω_o , and C_d values to be taken from Table 4.3-1, but prescribed less restrictive height limitations than those prescribed in Table 4.3-1. This inconsistency has been corrected. In addition, some nonbuilding structures similar to buildings are permitted with less restrictive height limitations if lower R values are used.

2003 CHAPTER 15, STRUCTURES WITH DAMPING SYSTEMS

See explanation above under Chapter 13.

**CHANGES IN SECTION NUMBERS BETWEEN THE
2000 AND 2003 EDITIONS PROVISIONS**

Chapter 1, GENERAL PROVISIONS

1.1 PURPOSE GENERAL

1.1.1 Purpose

1.1.2 Scope and application

1.1.3 References

1.1.4 Definitions

1.1.5 Notation

~~1.2 SCOPE AND APPLICATION~~

~~1.2.1 Scope~~

~~1.2.2 Additions~~

~~1.2.3 Change of Use~~

~~1.2.4 Alterations~~

~~1.2.5 Alternate Materials and Alternate Means and Methods of Construction~~

1.32 SEISMIC USE GROUPS

1.32.1 Seismic Use Group III

1.32.2 Seismic Use Group II

1.32.3 Seismic Use Group I

1.32.4 Multiple Use

1.32.5 Seismic Use Group III Structure Access Protection

~~1.43 OCCUPANCY IMPORTANCE FACTOR~~

1.4 SEISMIC DESIGN CATEGORY

1.4.1 Determination of Seismic Design Category

1.4.2 Site limitation for Seismic Design Categories E and F

1.5 SEISMIC DESIGN CATEGORY A

1.5.1 Lateral forces

1.5.2 Connections

1.5.3 Anchorage of concrete or masonry walls

1.5.4 Tanks assigned to Seismic use group III

Chapter 2, GLOSSARY AND NOTATIONS

~~2.1 GLOSSARY~~

~~2.2 NOTATIONS~~

Chapter 32, QUALITY ASSURANCE

32.1 SCOPE GENERAL

2.1.1 Scope

2.1.2 References

2.1.3 Definitions

2.1.4 Notation

~~32.2 QUALITY ASSURANCE~~

~~3.2.1 Details of Quality Assurance Plan~~

~~3.2.2 Contractor Responsibility~~

2.2 GENERAL REQUIREMENTS

- 2.2.1 Details of quality assurance plan
- 2.2.2 Contractor responsibility
- 32.3 SPECIAL INSPECTION
 - 32.3.1 Piers, Piles, Caissons
 - 32.3.2 Reinforcing Steel
 - 32.3.3 Structural Concrete
 - 32.3.4 Prestressed Concrete
 - 32.3.5 Structural Masonry
 - 32.3.6 Structural Steel
 - 32.3.7 Structural Wood
 - 32.3.8 Cold-Formed Steel Framing
 - 32.3.9 Architectural Components
 - 32.3.10 Mechanical and Electrical Components
 - 32.3.11 Seismic Isolation System
- 32.4 TESTING
 - 32.4.1 Reinforcing and Prestressing Steel
 - 32.4.2 Structural Concrete
 - 32.4.3 Structural Masonry
 - 32.4.4 Structural Steel
 - 32.4.5 Mechanical and Electrical Equipment
 - 32.4.6 Seismically Isolated Structures
- 32.5 STRUCTURAL OBSERVATIONS
- 32.6 REPORTING AND COMPLIANCE PROCEDURES

Chapter 43, GROUND MOTION

- ~~4.1 PROCEDURES FOR DETERMINING MAXIMUM CONSIDERED EARTHQUAKE AND DESIGN EARTHQUAKE GROUND MOTION ACCELERATIONS AND RESPONSE SPECTRA~~
 - ~~4.1.1 Maximum Considered Earthquake Ground Motions~~
 - ~~4.1.2 General Procedure for Determining Maximum Considered Earthquake and Design Spectral Response Accelerations~~
 - ~~4.1.3 Site Specific Procedure for Determining Ground Motion Accelerations~~
- ~~4.2 SEISMIC DESIGN CATEGORY~~
 - ~~4.2.1 Determination of Seismic Design Category~~
 - ~~4.2.2 Site Limitation for Seismic Design Categories E and F~~
- 3.1 GENERAL
 - 3.1.1 Scope
 - 3.1.2 References
 - 3.1.3 Definitions
 - 3.1.4 Notation
- 3.2 GENERAL REQUIREMENTS
 - 3.2.1 Site class
 - 3.2.2 Procedure selection
- 3.3 GENERAL PROCEDURE
 - 3.3.1 Mapped acceleration parameters
 - 3.3.2 Site coefficients and adjusted acceleration parameters
 - 3.3.3 Design acceleration parameters
 - 3.3.4 Design response spectrum
- 3.4 SITE SPECIFIC PROCEDURE
 - 3.4.1 Probabilistic maximum considered earthquake
 - 3.4.2 Deterministic maximum considered earthquake
 - 3.4.3 Site-specific maximum considered earthquake

3.4.4 Design response spectrum

3.5 SITE CLASSIFICATION FOR SEISMIC DESIGN

3.5.1 Site class definitions

Chapter 54, STRUCTURAL DESIGN CRITERIA

~~5.1 REFERENCE DOCUMENT~~

~~ASCE 7~~

~~5.2 DESIGN BASIS~~

~~5.2.1 General~~

~~5.2.2 Basic Seismic Force Resisting Systems~~

~~5.2.3 Structure Configuration~~

~~5.2.4 Redundancy~~

~~5.2.5 Analysis Procedures~~

~~5.2.6 Design and Detailing Requirements~~

~~5.2.7 Combination of Load Effects~~

~~5.2.8 Deflection and Drift Limits~~

~~5.3 INDEX FORCE ANALYSIS PROCEDURE~~

~~5.4 EQUIVALENT LATERAL FORCE PROCEDURE~~

~~5.4.1 Seismic Base Shear~~

~~5.4.2 Period Determination~~

~~5.4.3 Vertical Distribution of Seismic Forces~~

~~5.4.4 Horizontal Shear Distribution~~

~~5.4.5 Overturning~~

~~5.4.6 Drift Determination and P -Delta Effects~~

~~5.5 MODAL ANALYSIS PROCEDURE~~

~~5.5.1 Modeling~~

~~5.5.2 Modes~~

~~5.5.3 Modal Properties~~

~~5.5.4 Modal Base Shear~~

~~5.5.5 Modal Forces, Deflections, and Drifts~~

~~5.5.6 Modal Story Shears and Moments~~

~~5.5.7 Design Values~~

~~5.5.8 Horizontal Shear Distribution~~

~~5.5.9 Foundation Overturning~~

~~5.5.10 P -Delta Effects~~

~~5.6 LINEAR RESPONSE HISTORY ANALYSIS PROCEDURE~~

~~5.6.1 Modeling~~

~~5.6.2 Ground Motion~~

~~5.6.3 Response Parameters~~

~~5.7 NONLINEAR RESPONSE HISTORY ANALYSIS PROCEDURE~~

~~5.7.1 Modeling~~

~~5.7.2 Ground Motion and Other Loading~~

~~5.7.3 Response Parameters~~

~~5.7.4 Design Review~~

~~5.8 SOIL STRUCTURE INTERACTION EFFECTS~~

~~5.8.1 General~~

~~5.8.2 Equivalent Lateral Force Procedure~~

~~5.8.3 Modal Analysis Procedure~~

~~4.1 GENERAL~~

~~4.1.1 Scope~~

~~4.1.2 References~~

- 4.1.3 Definitions
- 4.1.4 Notation
- 4.2 GENERAL REQUIREMENTS
- 4.2.1 Design basis
- 4.2.2 Combination of load effects
- 4.3 SEISMIC-FORCE-RESISTING SYSTEM
- 4.3.1 Selection and limitations
- 4.3.2 Configuration
- 4.3.3 Redundancy
- 4.4 STRUCTURAL ANALYSIS
- 4.4.1 Procedure selection
- 4.4.2 Application of loading
- 4.5 DEFORMATION REQUIREMENTS
- 4.5.1 Deflection and drift limits
- 4.5.2 Seismic Design Categories B and C
- 4.5.3 Seismic Design Categories D, E, and F
- 4.6 DESIGN AND DETAILING REQUIREMENTS
- 4.6.1 Seismic design Category B
- 4.6.2 Seismic design Category C
- 4.6.3 Seismic Design Category D, E, and F

ALTERNATIVE SIMPLIFIED CHAPTER 4

Chapter 5 STRUCTURAL ANALYSIS PROCEDURES

- 5.1 GENERAL
- 5.1.1 Scope
- 5.1.2 Definitions
- 5.1.3 Notation
- 5.2 EQUIVALENT LATERAL FORCE PROCEDURE
- 5.2.1 Seismic base shear
- 5.2.2 Period determination
- 5.2.3 Vertical distribution of seismic forces
- 5.2.4 Horizontal shear distribution
- 5.2.5 Overturning
- 5.2.6 Drift determination and P-delta effects
- 5.3 RESPONSE SPECTRUM PROCEDURE
- 5.3.1 Modeling
- 5.3.2 Modes
- 5.3.3 Modal properties
- 5.3.4 Modal base shear
- 5.3.5 Modal forces, deflections and drifts
- 5.3.6 Modal story shears and moments
- 5.3.7 Design values
- 5.3.8 Horizontal shear distribution
- 5.3.9 Foundation overturning
- 5.3.10 P-delta effects
- 5.4 LINEAR RESPONSE HISTORY PROCEDURE
- 5.4.1 Modeling
- 5.4.2 Ground motion
- 5.4.3 Response parameters
- 5.5 NONLINEAR RESPONSE HISTORY PROCEDURE

5.5.1 Modeling

5.5.2 Ground motion and other loading

5.5.3 Response parameters

5.5.4 Design review

5.6 SOIL-STRUCTURE INTERACTION EFFECTS

5.6.1 General

5.6.2 Equivalent lateral force procedure

5.6.3 Response spectrum procedure

Appendix to Chapter 5, NONLINEAR STATIC ANALYSIS

**Chapter 6, ARCHITECTURAL, MECHANICAL, AND ELECTRICAL COMPONENTS
DESIGN REQUIREMENTS**

6.1 GENERAL

~~6.1.1 References and Standards~~

~~ASME A17.1~~

~~ASTM C635~~

~~ASME/BPV~~

~~ASTM C636~~

~~ANSI/ASME B31.1~~

~~ANSI/ASME B31.3~~

~~ANSI/ASME B31.4~~

~~ANSI/ASME B31.5~~

~~ANSI/ASME B31.9~~

~~ANSI/ASME B31.11~~

~~ANSI/ASME B31.8~~

~~NFPA 13~~

~~IEEE 344~~

~~ASHRAE SRD~~

~~CISCA Rees for Zones 0-2~~

~~CISCA Rees for Zones 3-4~~

~~SMACNA HVAC~~

~~SMACNA Rectangular~~

~~SMACNA Restraint~~

~~AAMA 501.4~~

6.1.1 Scope

6.1.2 References

6.1.3 Definitions

6.1.4 Notation

6.2 GENERAL DESIGN REQUIREMENTS

~~6.1.2.1 Component Force Transfer~~ Seismic Design Category

~~6.1.2.2 Seismic Forces~~ Component Importance Factor

~~6.1.2.3 Seismic Relative Displacements~~ Consequential damage

~~6.1.2.4 Component Importance Factor~~ Flexibility

6.2.5 Component force transfer

6.2.6 Seismic forces

6.2.7 Seismic relative displacements

~~6.1.2.8~~ Component Anchorage

~~6.1.2.9~~ Construction Documents

6.2.3 ARCHITECTURAL COMPONENT DESIGN

~~6.2.1~~ General

~~6.2.2-3.1~~ Architectural Component Forces and Displacements

~~6.2.33.2~~ Architectural Component Deformation

~~6.2.43.3~~ Exterior Nonstructural Wall Elements and Connections

~~6.2.53.3~~ Out-of-Plane Bending

~~6.2.63.4~~ Suspended Ceilings

~~6.2.73.5~~ Access Floors

~~6.2.83.6~~ Partitions

~~6.3.7~~ General

~~6.2.9~~ ~~Steel Storage Racks~~

~~6.2.103.8~~ Glass in Glazed Curtain Walls, Glazed Storefronts, and Glazed Partitions

~~6.34~~ MECHANICAL AND ELECTRICAL COMPONENT DESIGN

~~6.34.1~~ ~~General Component period~~

~~6.34.2~~ Mechanical and Electrical Component Forces and Displacements

~~6.34.3~~ Mechanical and Electrical Component Period

~~6.3.4~~ Mechanical and Electrical Component Attachments

~~6.3.54.4~~ Component Supports and attachments

~~6.3.6~~ Component Certification

~~6.3.74.5~~ Utility and Service Lines at Structure Interfaces

~~6.3.8~~ Site Specific Considerations

~~6.3.9~~ Storage Tanks

~~6.3.104.6~~ HVAC Ductwork

~~6.3.114.7~~ Piping Systems

~~6.3.124.8~~ Boilers and Pressure Vessels

~~6.3.13~~ Mechanical Equipment Attachments, and Supports

~~6.3.14~~ Electrical Equipment Attachments, and Supports

~~6.3.15~~ Alternative Seismic Qualification Methods

~~6.3.164.9~~ Elevator Design Requirements

Appendix to Chapter 6, ALTERNATIVE PROVISIONS FOR THE DESIGN OF PIPING SYSTEMS

Chapter 7, FOUNDATION DESIGN REQUIREMENTS

7.1 GENERAL

7.1.1 Scope

7.1.2 References

7.1.3 Definitions

7.1.4 Notation

~~7.2~~ ~~STRENGTH OF COMPONENTS AND FOUNDATIONS~~ General Design Requirements

~~7.2.1~~ ~~Structural Materials~~ Foundation components

7.2.2 Soil Capacities

7.2.3 Foundation load-deformation characteristics

7.3 SEISMIC DESIGN CATEGORIES A AND B

7.4 SEISMIC DESIGN CATEGORY C

7.4.1 Investigation

7.4.2 Pole-Type Structures

7.4.3 Foundation Ties

7.4.4 Special Pile Requirements

7.5 SEISMIC DESIGN CATEGORIES D, E, AND F

7.5.1 Investigation

- 7.5.2 Foundation Ties
- 7.5.3 Liquefaction Potential and Soil Strength Loss
- 7.5.4 Special Pile and Grade Beam Requirements

Appendix to Chapter 7, GEOTECHNICAL ULTIMATE STRENGTH DESIGN
OF FOUNDATIONS AND FOUNDATION LOAD-DEFORMATION
MODELING

Chapter 8, STEEL STRUCTURE DESIGN REQUIREMENTS

8.1 ~~REFERENCE DOCUMENTS—GENERAL~~

- ~~AISC LRFD~~
- ~~AISC ASD~~
- ~~AISC Seismic~~
- ~~AISI~~
- ~~ANSI/ASCE 8-90~~
- ~~SJI~~
- ~~ASCE 19~~

8.1.1 Scope

8.1.2 References

8.1.3 Definitions

8.1.4 Notation

8.2 ~~SEISMIC REQUIREMENTS FOR STEEL STRUCTURES~~ GENERAL DESIGN REQUIREMENTS

8.2.1 Seismic Design Categories B and C

8.2.2 Seismic Design categories D, E, and F

8.3 ~~SEISMIC DESIGN CATEGORIES A, B, AND C~~ STRUCTURAL STEEL

8.3.1 Material properties for determination of required strength

~~8.4 SEISMIC DESIGN CATEGORIES D, E, AND F~~

~~8.4.1 Modifications to AISC Seismic~~

8.5 4 COLD-FORMED STEEL SEISMIC REQUIREMENTS

8.4.1 Modifications to references

8.4.2 Light-frame walls

8.4.3 Prescriptive framing

8.4.4 Steel deck diaphragms

~~8.5.1 Modifications to AISI~~

~~8.5.2 Modifications to ANSI/ASCE 8-90~~

~~8.6 LIGHT FRAMED WALLS~~

~~8.6.1 Boundary Members~~

~~8.6.2 Connections~~

~~8.6.3 Braced Bay Members~~

~~8.6.4 Diagonal Braces~~

~~8.6.5 Shear Walls~~

~~8.7 SEISMIC REQUIREMENTS FOR STEEL DECK DIAPHRAGMS~~

8.8 5 STEEL CABLES

8.6 RECOMMENDED PROVISIONS FOR BUCKLING-RESTRAINED BRACED FRAMES

8.6.1 Symbols

8.6.2 Glossary

8.6.3 Buckling-restrained braced frames (BRBF)

8.7 RECOMMENDED PROVISIONS FOR SPECIAL STEEL PLATE WALLS

8.7.1 Symbols

8.7.2 Glossary

8.7.3 Scope

8.7.4 Webs

8.7.5 Connections of webs to boundary elements

8.7.6 Horizontal and vertical boundary elements (HBE and VBE)

Chapter 9, CONCRETE STRUCTURE DESIGN REQUIREMENTS

9.1 REFERENCE DOCUMENTS GENERAL

~~ACI 318~~

~~ACI ITG/T1.1~~

~~ASME B1.1~~

~~ASME B18.2.1~~

~~ASME B18.2.6.9~~

~~ATC 24~~

~~9.1.1 Modifications to ACI 318 Ref. 9-1 Scope~~

~~9.1.2 References~~

~~9.1.3 General definitions~~

~~9.2 ANCHORING TO CONCRETE GENERAL DESIGN REQUIREMENTS~~

~~9.2.1 Scope~~

~~9.2.2 Notations and Definitions~~

~~9.2.3 General Requirements~~

~~9.2.4 General Requirements for Strength of Structural Anchors~~

~~9.2.5 Design Requirements for Tensile Loading~~

~~9.2.6 Design Requirements for Shear Loading~~

~~9.2.7 Interaction of Tensile and Shear Forces~~

~~9.2.8 Required Edge Distances, Spacings, and Thicknesses to Preclude Splitting Failure~~

~~9.2.9 Installation of Anchors~~

~~9.2.1 Classification of shear walls~~

~~9.2.2 Modifications to ACI 318~~

~~9.3 CLASSIFICATION OF SHEAR WALLS~~

~~9.3.1 Ordinary Plain Concrete Shear Walls~~

~~9.3.2 Detailed Plain Concrete Shear Walls~~

~~9.4 SEISMIC DESIGN CATEGORY A~~

~~9.5 3 SEISMIC DESIGN CATEGORY B~~

~~9.5.3-1 Ordinary Moment Frames~~

~~9.64 SEISMIC DESIGN CATEGORY C~~

~~9.6.1 Seismic Force Resisting Systems~~

~~9.6.2 Discontinuous Members~~

~~9.4.1 Classification of shear walls~~

~~9.6.34.2 Plain Concrete~~

~~9.6.4 Anchor Bolts in the Tops of Columns~~

~~9.75 SEISMIC DESIGN CATEGORIES D, E, OR F~~

~~9.7.1 Seismic Force Resisting Systems~~

~~9.7.2 Frame Members Not Proportioned to Resist Forces Induced by Earthquake Motions~~

~~9.6 ACCEPTANCE CRITERIA FOR SPECIAL PRECAST STRUCTURAL~~

~~WALLS BASED ON VALIDATION TESTING~~

~~9.6.1 Notation~~

~~9.6.2 Definitions~~

~~9.6.3 Scope and general requirements~~

~~9.6.4 Design procedure~~

9.6.5 Test modules

9.6.6 Testing agency

9.6.7 Test method

9.6.8 Test report

9.6.9 Test module acceptance criteria

9.6.10 Reference

Appendix to Chapter 9, REINFORCED CONCRETE DIAPHRAGMS CONSTRUCTED USING UNTOPPED PRECAST CONCRETE ELEMENTS

Chapter 10, STEEL AND CONCRETE STRUCTURE DESIGN REQUIREMENTS

10.1 REFERENCE DOCUMENTS GENERAL

ACI 318

AISC/LRFD

AISC Seismic

AISI

10.1.1 Scope

10.1.2 References

10.1.3 Definitions

10.1.4 Notation

10.2 GENERAL DESIGN REQUIREMENTS

10.3 SEISMIC DESIGN CATEGORIES B AND C

10.4 SEISMIC DESIGN CATEGORIES D, E, AND F

10.5 MODIFICATIONS TO AISC SEISMIC, PART II

10.5.1 Changes to nomenclature

10.5.2 Changes to definitions in the AISC Glossary

10.5.3 Changes to section 1-SCOPE

10.5.4 Changes to Section 2 – REFERENCED SPECIFICATIONS,
CODES AND STANDARDS

10.5.5 Changes to Section 3 – SEISMIC DESIGN CATEGORIES

10.5.6 Changes to Section 4 – LOADS, LOAD COMBINATIONS
AND NOMINAL STRENGTHS

10.5.7 Changes to Section 5.2 – Concrete and steel reinforcement

10.5.8 Changes to Section 6.3 - COMPOSITE BEAMS

10.5.9 Changes to Section 6.4 – Reinforced-Concrete-Encased
Composite Columns

10.5.10 Changes to Section 6.4a – Ordinary Seismic System
Requirements

10.5.11 Changes to Section 6.5 – CONCRETE-FILLED COMPOSITE
COLUMNS

10.5.12 Changes to Section 6.5a – CONCRETE-FILLED COMPOSITE
COLUMNS

10.5.13 Changes to Section 7.3 – NOMINAL STRENGTH OF
CONNECTIONS

10.5.14 Changes to Section 8.2 – COLUMNS

10.5.15 Changes to Section 8.3 – COMPOSITE BEAMS

10.5.16 Changes to Section 8.4 – Partially Restrained (PR) Moment
Connections

10.5.17 Changes to Section 9.3 – BEAMS

- 10.5.18 Changes to Section 9.4 – MOMENT CONNECTIONS
- 10.5.19 Changes to Section 9.5 – COLUMN-BEAM MOMENT RATIO
- 10.5.20 Changes to Section 10.2 – COLUMNS
- 10.5.21 Changes to Section 10.4 – MOMENT CONNECTIONS
- 10.5.22 Changes to Section 11.4 – MOMENT CONNECTIONS
- 10.5.23 Changes to Section 12.4 – BRACES
- 10.5.24 Changes Title for Section 15.3
- 10.5.25 Changes Title for Section 16.3
- 10.5.26 Add New Section 15.4
- 10.5.27 Add New Section 16.4

Chapter 11, MASONRY STRUCTURE DESIGN REQUIREMENTS

11.1 GENERAL

11.1.1 Scope

11.1.2 Reference Documents

ACI 318

ACI 530

ACI 530.1

~~11.1.3 Definitions~~

~~11.1.4 Notations~~

~~11.2 CONSTRUCTION REQUIREMENTS~~

~~11.2.1 General~~

~~11.2.2 Quality Assurance~~

11.3 GENERAL DESIGN REQUIREMENTS

~~11.3.1 Scope~~

~~11.3.2 Empirical Masonry Design~~

~~11.3.3 Plain (Unreinforced) Masonry Design~~

~~11.3.4 Reinforced Masonry Design~~

~~11.3.5 Seismic Design Category A~~

~~11.3.6 Seismic Design Category B~~

~~11.3.7 Seismic Design Category C~~

~~11.3.8 Seismic Design Category D~~

~~11.3.9 Seismic Design Categories E and F~~

~~11.3.10 Properties of Materials~~

~~11.3.11 Section Properties~~

~~11.3.12 Headed and Bent Bar Anchor Bolts~~

11.2.1 Classification of shear walls

11.2.2 Modifications to ACI 530/ADCE 5/TMS 402 and ACI 530.1/ASCE 5/TMS 602

~~11.4 DETAILS OF REINFORCEMENT~~

~~11.4.1 General~~

~~11.4.2 Size of Reinforcement~~

~~11.4.3 Placement Limits for Reinforcement~~

~~11.4.4 Cover for Reinforcement~~

~~11.4.5 Development of Reinforcement~~

~~11.5 STRENGTH AND DEFORMATION REQUIREMENTS~~

~~11.5.1 General~~

~~11.5.2 Required Strength~~

~~11.5.3 Design Strength~~

~~11.5.4 Deformation Requirements~~

~~11.6 FLEXURE AND AXIAL LOADS~~

~~11.6.1 Scope~~

~~11.6.2 Design Requirements of Reinforced Masonry Members~~

~~11.6.3 Design of Plain (Unreinforced) Masonry Members~~

~~11.7 SHEAR~~

~~11.7.1 Scope~~

~~11.7.2 Shear Strength~~

~~11.7.3 Design of Reinforced Masonry Members~~

~~11.7.4 Design of Plain (Unreinforced) Masonry Members~~

~~11.8 SPECIAL REQUIREMENTS FOR BEAMS~~

~~11.9 SPECIAL REQUIREMENTS FOR COLUMNS~~

~~11.10 SPECIAL REQUIREMENTS FOR SHEAR WALLS~~

~~11.10.1 Ordinary Plain Masonry Shear Walls~~

~~11.10.2 Detailed Plain Masonry Shear Walls~~

~~11.10.3 Ordinary Reinforced Masonry Shear Walls~~

~~11.10.4 Intermediate Reinforced Masonry Shear Walls~~

~~11.10.5 Special Reinforced Masonry Shear Walls~~

~~11.10.6 Flanged Shear Walls~~

~~11.10.7 Coupled Shear Walls~~

~~11.113 SPECIAL MOMENT FRAMES OF MASONRY~~

~~11.113.1 Calculation of Required Strength~~

~~11.113.2 Flexural Yielding~~

~~11.3.3 Materials~~

~~11.113.34 Reinforcement~~

~~11.113.4 5 Wall Frame Beams~~

~~11.113.5 6 Wall Frame Columns~~

~~11.113.67 Wall Frame Beam-Column Intersection~~

~~11.124 GLASS-UNIT MASONRY AND MASONRY VENEER~~

~~11.124.1 Design Lateral Forces and Displacements~~

~~11.124.2 Glass-Unit Masonry Design~~

~~11.124.3 Masonry Veneer Design~~

~~11.5 PRESTRESSED MASONRY~~

Chapter 12, WOOD STRUCTURE DESIGN REQUIREMENTS

12.1 GENERAL

12.1.1 Scope

12.1.2 Reference Documents

ASCE 16

APA Y510T

APA N375B

APA E315H

CABO Code

NFoPA T903

PS20

ANSI/AITC A190.1

ASTM D5055-95A

PS-1

PS-2

ANSI 05.1

ANSI A208.1

~~AWPA C1, 2, 2, 3, 9, 28~~

12.1.3 Definitions

~~12.1.34 Notations~~

12.2 DESIGN METHODS

~~12.2.1 Engineered Wood Design~~

~~12.2.2 Conventional Light Frame Construction~~

12.2.1 Seismic design categories B, C, and D

12.2.2 Seismic design Categories E and F

12.2.3 Modifications to AF&PA SDPWS for Seismic Design

Categories B, C, and D

12.2.4 Modifications to AF&PA SDPWS for Seismic Design

Categories E, and F

12.3 GENERAL DESIGN REQUIREMENTS FOR ENGINEERED WOOD CONSTRUCTION

~~12.3.1 General~~

~~12.3.2 Shear Resistance Based on Principles of Mechanics~~

~~12.3.3 Deformation Compatibility Requirements~~

~~12.3.4 Framing Requirements~~

~~12.3.5 Sheathing Requirements~~

~~12.3.6 Wood Members Resisting Horizontal Seismic Forces Contributed by Masonry and Concrete~~

~~12.4 DIAPHRAGMS AND SHEAR WALLS~~

~~12.4.1 Diaphragms~~

~~12.4.2 Shear Walls~~

~~12.4.3 Perforated Shear Walls~~

12.5 4 CONVENTIONAL LIGHT-FRAME CONSTRUCTION

~~12.5.1 Scope Limitations~~

~~12.5.2 Braced Walls~~

~~12.5.3 Detailing Requirements~~

~~12.6 SEISMIC DESIGN CATEGORY A~~

~~12.7 SEISMIC DESIGN CATEGORIES B, C, AND D~~

~~12.7.1 Conventional Light Frame Construction~~

~~12.7.2 Engineered Construction~~

~~12.8 SEISMIC DESIGN CATEGORIES E AND F~~

~~12.8.1 Limitations~~

Chapter 13, SEISMICALLY ISOLATED STRUCTURES DESIGN REQUIREMENTS

13.1 GENERAL

13.1.1 Scope

13.1.2 Definitions

13.1.3 Notation

~~13.2 CRITERIA SELECTION~~

~~13.2.1 Basis for Design~~

~~13.2.2 Stability of the Isolation System~~

~~13.2.3 Seismic Use Group~~

~~13.2.4 Configuration Requirements~~

~~13.2.5 Selection of Lateral Response Procedure~~

13.2 GENERAL DESIGN REQUIREMENTS

13.2.1 Occupancy importance factor

13.2.2 Configuration

- 13.2.3 Ground motion
- 13.2.4 Procedure selection
- 13.2.5 Isolation system
- 13.2.6 Structural system
- 13.2.7 Elements of structures and nonstructural components
- 13.3 EQUIVALENT LATERAL FORCE PROCEDURE
- ~~13.3.1 General~~
- 13.3.2 1 Deformation Characteristics of the Isolation System
- 13.3.3 2 Minimum Lateral Displacements
- 13.3.4 3 Minimum Lateral Forces
- 13.3.5 4 Vertical Distribution of Force
- 13.3.6 5 Drift Limits
- 13.4 DYNAMIC LATERAL RESPONSE PROCEDURE
- 13.4.1 ~~General~~ Modeling
- 13.4.2 ~~Isolation System and Structural Elements Below the Isolation System~~ Description of procedures
- 13.4.3 ~~Structural Elements Above the Isolation System~~ Minimum lateral displacements and forces
- 13.4.4 ~~Ground Motion~~ Drift limits
- ~~13.4.5 Mathematical Model~~
- ~~13.4.6 Description of Analysis Procedures~~
- ~~13.4.7 Design Lateral Force~~
- 13.5 ~~LATERAL LOAD ON ELEMENTS OF STRUCTURES AND NONSTRUCTURAL COMPONENTS SUPPORTED BY BUILDINGS~~ DESIGN REVIEW
- ~~13.5.1 General~~
- ~~13.5.2 Forces and Displacements~~
- 13.6 DETAILED SYSTEM REQUIREMENTS
- ~~13.6.1 General~~
- ~~13.6.2 Isolation System~~
- ~~13.6.3 Structural System~~
- 13.7 FOUNDATIONS
- 13.8 DESIGN AND CONSTRUCTION REVIEW
- ~~13.8.1 General~~
- ~~13.8.2 Isolation System~~
- 13.9 6 REQUIRED TESTS OF THE ISOLATION SYSTEM TESTING
- ~~13.9.1 General~~
- ~~13.9.2.6.1~~ Prototype Tests
- ~~13.9.36.2~~ Determination of Force-Deflection Characteristics
- ~~13.9.46.3~~ Test Specimen Adequacy
- ~~13.9.56.4~~ Design Properties of the Isolation System

~~Appendix to Chapter 13, STRUCTURES WITH DAMPING SYSTEMS~~

Chapter 14, NONBUILDING STRUCTURE DESIGN REQUIREMENTS

- 14.1 GENERAL
- 14.1.1 Scope
- 14.1.2 References
- 14.1.3 Definitions
- 14.1.4 Notation
- 14.1.5 Nonbuilding structures supported by other structures
- 14.2 REFERENCES
- 14.3 INDUSTRY DESIGN STANDARDS AND RECOMMENDED PRACTICE

~~14.4 NONBUILDING STRUCTURES SUPPORTED BY OTHER STRUCTURES~~

~~14.4.1 Architectural, Mechanical, and Electrical Components~~

~~14.5 2 STRUCTURAL GENERAL DESIGN REQUIREMENTS~~

~~14.5.1 Design Basis~~

~~14.5.2 Rigid Nonbuilding Structures~~

~~14.5.3 Loads~~

~~14.5.4 Fundamental Period~~

~~14.5.5 Drift Limitations~~

~~14.5.6 Materials Requirements~~

~~14.5.7 Deflection Limits and Structure Separation~~

~~14.5.8 Site Specific Response Spectra~~

14.2.1 Seismic Use groups and importance factors

14.2.2 Ground motion

14.2.3 Design basis

14.2.4 Seismic-force-resisting system selection and limitations

14.2.5 Structural analysis procedure selection

14.2.6 Seismic weight

14.2.7 Rigid nonbuilding structures

14.2.8 Minimum base shear

14.2.9 Fundamental period

14.2.10 Vertical distribution of seismic forces

14.2.11 Deformation requirements

14.2.12 Nonbuilding structure classification

~~14.6 3 NONBUILDING STRUCTURES SIMILAR TO BUILDINGS~~

~~14.6.3 1 General Electrical Power Generating Facilities~~

~~14.6.3.2 Pipe Racks Structural Towers for Tanks and Vessels~~

~~14.6.3.3 Steel Storage Racks Piers and Wharves~~

~~14.6.3.4 Electrical Power Generating Facilities Pipe Racks~~

~~14.6.3.5 Structural Towers for Tanks and Vessels Steel Storage Racks~~

~~14.6.6 Piers and Wharves~~

~~14.7 NONBUILDING STRUCTURES NOT SIMILAR TO BUILDINGS~~

~~14.7.1 General~~

~~14.7.2 Earth Retaining Structures~~

~~14.7.3 Tanks and Vessels Stacks and Chimneys~~

~~14.7.4 Stacks and Chimneys Amusement Structures~~

~~14.7.5 Amusement Structures Special Hydraulic Structures~~

~~14.7.6 Special Hydraulic Structures Secondary Containment Systems~~

~~14.7.7 Secondary Containment Systems Tanks and Vessels~~

Appendix to Chapter 14 OTHER NONBUILDING STRUCTURES

Chapter 15 STRUCTURES WITH DAMPING SYSTEMS

15.1 GENERAL

15.1.1 Scope

15.1.2 Definitions

15.1.3 Notation

15.2 GENERAL DESIGN REQUIREMENTS

15.2.1 Seismic Design Category A

15.2.2 System requirements

15.2.3 Ground motion

15.2.4 Procedure selection

15.2.5 Damping system

15.3 NONLINEAR PROCEDURES

15.3.1 Nonlinear response history procedure

15.3.2 Nonlinear static procedure

15.4 RESPONSE SPECTRUM PROCEDURE

15.4.1 Modeling

15.4.2 Seismic-force-resisting system

15.4.3 Damping system

15.5 EQUIVALENT LATERAL FORCE PROCEDURE

15.5.1 Modeling

15.5.2 Seismic-force-resisting system

15.5.3 Damping system

15.6 DAMPED RESPONSE MODIFICATION

15.6.1 Damping coefficient

15.6.2 Effective damping

15.6.3 Effective ductility demand

15.6.4 Maximum effective ductility demand

15.7 SEISMIC LOAD CONDITIONS AND ACCEPTANCE CRITERIA

15.7.1 Nonlinear procedures

15.7.2 Seismic-force-resisting system

15.7.3 Damping system

15.8 DESIGN REVIEW

15.9 TESTING

15.9.1 Prototype tests

15.9.2 Production testing

Appendix B

PARTICIPANTS IN THE BSSC 2003 *PROVISIONS* UPDATE PROGRAM

2001 BSSC BOARD OF DIRECTION

Chair

Charles Thornton, Ph.D., PE, The Thornton ■ Tomasetti Group, Inc., New York, New York

Vice Chair

S. K. Ghosh, Ph.D., S. K. Ghosh Associates, Inc., Northbrook, Illinois (representing the Portland Cement Association)

Secretary

Charles Carter, PE, American Institute of Steel Construction, Chicago, Illinois

Ex Officio

William W. Stewart, FAIA, Stewart-Schaberg Architects, Clayton, Missouri

Members

J. Gregg Borchelt, PE, Brick Institute of America, Reston, Virginia

Bradford K. Douglas, PE, American Forest and Paper Association, Washington, D.C.

Edwin Dean, PE, SE, Nishkian Dean, Portland, Oregon (representing the Applied Technology Council)

Henry Green, Bureau of Construction Codes, State of Michigan Department of Consumer and Industry Services, Okemos, Michigan (representing the National Institute of Building Sciences)

H. S. Lew, Ph.D., PE, National Institute of Standards and Technology, Gaithersburg, Maryland (representing the Interagency Committee for Seismic Safety in Construction)

Joseph Nicoletti, PE, URS/John A. Blume and Associates, San Francisco, California (representing the Earthquake Engineering Research Institute)

James Rinner, Turner Construction, Dixon, California (representing the Association General Contractors of America)

James Rossberg, PE, American Society of Civil Engineers, Reston, Virginia

Jeffrey Sciaudone, PE, Institute for Building and Home Safety, Tampa, Florida

W. Lee Shoemaker, Ph.D., Metal Building Manufacturers Association, Cleveland, Ohio

Howard Simpson, Sc.D., P.E., Simpson, Gumpertz and Heger, Arlington, Massachusetts (representing the National Council of Structural Engineers Associations)

Charles Spitz, NCARB, AIA, CSI, Architect/Planner Code Consultant, Wall, New Jersey (representing the American Institute of Architects)

David Wismer, PE, CBO, Department of Licenses and Inspections, Philadelphia, Pennsylvania (representing the Building Officials and Code Administrators International)

BSSC Staff

Claret M. Heider, NIBS Vice President, BSSC/MMC

Bernard F. Murphy, PE, Director, Special Projects

Carita Tanner, Editorial and Public Relations Manager

Patricia Blasi, Administrative Assistant

2002 BSSC BOARD OF DIRECTION

Chair

Charles Thornton, Ph.D., PE, The Thornton ■ Tomasetti Group, Inc., New York, New York

Vice Chair

S. K. Ghosh, Ph.D., S. K. Ghosh Associates, Inc., Northbrook, Illinois (representing the Portland Cement Association)

Secretary

Charles Carter, PE, American Institute of Steel Construction, Chicago, Illinois

Ex Officio

William W. Stewart, FAIA, Stewart-Schaberg Architects, Clayton, Missouri

Members

David R. Bonneville, PE, SE, Degenkolb Engineers, San Francisco (representing the EarthquakeEngineering Research Institute)

J. Gregg Borchelt, PE, Brick Institute of America, Reston, Virginia

Bradford K. Douglas, PE, American Forest and Paper Association, Washington, D.C.

Edwin Dean, PE, SE, Nishkian Dean, Portland, Oregon (representing the Applied Technology Council)

Henry Green, Bureau of Construction Codes, State of Michigan Department of Consumer and Industry Services, Okemos, Michigan (representing the National Institute of Building Sciences)

H. S. Lew, Ph.D., PE, National Institute of Standards and Technology, Gaithersburg, Maryland (representing the Interagency Committee for Seismic Safety in Construction)

James Rinner, Turner Construction, Dixon, California (representing the Associated General Contractors of America)

James Rossberg, PE, American Society of Civil Engineers, Reston, Virginia

Grover Lee Sawyer, Jr., PE, North Carolina Department of Insurance, Office of the State Fire Marshall, Raleigh (representing the International Code Council)

Jeffrey Sciaudone, PE, Institute for Building and Home Safety, Tampa, Florida

W. Lee Shoemaker, Ph.D., Metal Building Manufacturers Association, Cleveland, Ohio

Howard Simpson, Sc.D., P.E., Simpson, Gumpertz and Heger, Arlington, Massachusetts (representing the National Council of Structural Engineers Associations)

Charles Spitz, NCARB, AIA, CSI, Architect/Planner Code Consultant, Wall, New Jersey (representing the American Institute of Architects)

BSSC Staff

Claret M. Heider, NIBS Vice President, BSSC/MMC

Bernard Murphy, PE, Director, Special Projects

Carita Tanner, Communications and Public Relations Manager

Patricia Blasi, Administrative Assistant

2003 BSSC BOARD OF DIRECTION

Chairman

Charles Thornton, Chairman/Principal, Thornton-Tomasetti Group, Inc., New York, New York

Vice Chairman

David Bonneville, Degenkolb Engineers, San Francisco, California

Secretary

Charles Carter, Chief Structural Engineer, American Institute of Steel Construction, Chicago, Illinois

Ex-Officio

William W. Stewart, Stewart-Schaberg Architects, Clayton, Missouri (representing the American Institute of Architects)

Members

J. Gregg Borchelt, Vice President, Brick Industry Association, Reston, Virginia

Edwin Dean, Nishkian Dean, Portland, Oregon

Bradford K. Douglas, Director of Engineering, American Forest and Paper Association, Washington, D.C.

Henry Green, Executive Director, Bureau of Construction Codes and Fire Safety, State of Michigan, Department of Labor and Economic Growth, Lansing, Michigan (representing the National Institute of Building Sciences)

H.S. Lew, Senior Research Engineer, National Institute of Standards and Technology, Gaithersburg, Maryland (representing Interagency Committee on Seismic Safety in Construction)

Joseph Messersmith, Coordinating Manager, Regional Code Services, Portland Cement Association, Rockville, Virginia (representing the Portland Cement Association)

Jim Rinner, Project Manager II, Kitchell CEM, Sacramento, California

James Rossberg, Manager, Technical Activities for the Structural Engineering Institute, American Society of Civil Engineers, Reston Virginia

Jeffery Sciadone, Associate Director, of Engineering, Institute of Business and Home Safety, Tampa, Florida

W. Lee Shoemaker, Director, Engineering and Research, Metal Building Manufacturers Association, Cleveland, Ohio

Howard Simpson, Simpson Gumpertz and Heger, Arlington, Massachusetts (representing National Council of Structural Engineers Associations)

Charles A. Spitz, Architect/Planner/Code Consultant, Wall New Jersey (representing the American Institute of Architects)

BSSC STAFF

Claret M. Heider, Vice President for BSSC Programs

Bernard F. Murphy, Director, Special Projects

Carita Tanner, Communications/Public Relations Manager

Patricia Blasi, Administrative Assistant

2003 PROVISIONS UPDATE COMMITTEE

Chair

Ronald O. Hamburger, Simpson Gumpertz and Heger, San Francisco, California

Representing Technical Subcommittee 1, Design Mapping

C. B. Crouse, URS Corporation, Seattle, Washington

R. Joe Hunt, BWXT Y-12, LLC, Oak Ridge, Tennessee

E. V. Leyendecker, U.S. Geological Survey, Denver, Colorado

Representing Technical Subcommittee 2, Design Criteria and Analysis

John D. Hooper, Magnusson Klemencic, Seattle, Washington

James R. Harris, J. R. Harris and Company, Denver, Colorado

Charles Kircher, Charles Kircher and Associates Consulting Engineers, Palo Alto, California

Representing Technical Subcommittee 3, Foundations and Geotechnical Considerations

Maurice S. Power, Geomatrix Consultants, Oakland, California

Roger Borchardt, U.S. Geological Survey, Menlo Park, California

Representing Technical Subcommittee 4, Concrete Structures

Neil Hawkins, Professor Emeritus, University of Illinois, Clyde Hill, Washington

Joseph J. Messersmith, Regional Code Services, Portland Cement Association, Rockville, Virginia

Jack P. Moehle, Pacific Earthquake Engineering Research Center, Richmond, California

Representing Technical Subcommittee 5, Masonry Structures

Daniel Shapiro, SOHA Engineers, San Francisco, California

Daniel P. Abrams, MAE Center, University of Illinois, Urbana

Jason J. Thompson, National Concrete Masonry Association, Herndon, Virginia

Representing Technical Subcommittee 6, Steel Structures

James O. Malley, Degenkolb Engineers, San Francisco, California

Harry W. Martin, American Iron and Steel Institute, Auburn, California

C. Mark Saunders, Rutherford and Chekene, Oakland, California

Representing Technical Subcommittee 7, Wood Structures

Philip Line, American Forest and Paper Association, Washington, D.C.

James E. Russell, Building Code Consultant, Concord, California

Erol Karacabeyli, Forintek Canada Corporation, Vancouver, British Columbia, Canada

Representing Technical Subcommittee 8, Mechanical/Electrical Systems and Building Equipment and Architectural Elements

John D. Gillengerten, Office of Statewide Health and Planning and Development, Sacramento, California

Pat Lama, Mason Industries, Hauppauge, New York

John F. Silva, Hilti Incorporated, San Rafael, California

Representing Technical Subcommittee 9, Quality Assurance

Douglas M. Smits, Division of Building Inspections, City of Charleston, South Carolina

Jim W. Sealy, Jim W. Sealy/Architect/Consultant, Dallas, Texas

Representing Technical Subcommittee 10, Low Rise and Residential Structures

J. Daniel Dolan, Washington State University, Pullman, Washington

Representing Technical Subcommittee 11, Composite Steel and Concrete Structures

Roberto T. Leon, Georgia Institute of Technology, Atlanta, Georgia

Jerome Hajjar, University of Minnesota, Minneapolis, Minnesota

Representing Technical Subcommittee 12, Base Isolation and Energy Dissipation

Michael Constantinou, University at Buffalo, State University of New York, Buffalo

Martin Johnson, ABS Consulting, Irvine, California

Representing Technical Subcommittee 13, Nonbuilding Structures

Stephen W. Meier, Tank Industry Consultants, Indianapolis, Indiana

John T. Hutton, Uzun and Case Engineers, Atlanta, Georgia

Richard Drake, J.S. Dyer and Associates, Irvine, California

Gayle Johnson, Han-Padron Associates, Oakland, California

Harold Sprague, Structural Engineer, Black and Veatch, Overland Park, Kansas

At-Large Member

Ed Sutton, National Association of Home Builders, Washington, D.C.

Robert McCluer, International Code Council, Country Club Hills, Illinois

Bonnie Manley, National Fire and Protection Association, Quincy, Massachusetts

Dominic Kelly, Simpson Gumpetz and Heger, Waltham, Massachusetts

Robert E. Bachman, Consulting Structural Engineer, Westlake Village, California

Ex-officio Voting Member

William T. Holmes, Rutherford and Chekene, Oakland, California

PUC TECHNICAL SUBCOMMITTEES

Technical Subcommittee 1, DESIGN MAPPING

Chair

C.B. Crouse, URS Corporation, Seattle, Washington

Members

Roger Borcherdt, U.S. Geological Survey, Menlo Park, California

R. Joe Hunt, BWXT Y-12, LLC, Oak Ridge, Tennessee

Jeffrey K. Kimball, Engineering and Operations Support, U.S. Department of Energy, Germantown, Maryland

E.V. Leyendecker, U.S. Geological Survey, Denver, Colorado

Lance Manuel, University of Texas, Austin, Texas

Walter Silva, Pacific Engineering Analysis, El Cerrito, California

Paul G. Somerville, Woodward-Clyde Federal Services, Pasadena, California

Eugene L. Trahern, Coughlin Porter Lundeen, Seattle, Washington

Michael Valley, Magnusson Klemencic, Seattle, Washington

Corresponding Members

Nathan Gould, ABS Consulting, St Louis, Missouri

Richard McConnell, Consultant, Springfield, Virginia

Technical Subcommittee 2, DESIGN CRITERIA AND ANALYSIS

Chair

John D. Hooper, Magnusson Klemencic, Seattle, Washington

Members

Mark Ascheim, University of Illinois, Urban, Illinois

James R. Harris, J.R. Harris and Company, Denver, Colorado

Charles Kircher, Charles Kircher and Associates Consulting Engineers, Palo Alto, California

Richard J. Phillips, Martin and HBL, Los Angeles, California

Chia-Ming Uang, University of California, La Jolla, California

Corresponding Members

David Bonowitz, San Francisco, California

David Bonneville, Degenkolb Engineers, San Francisco, California

Finley Charney, Virginia Polytechnic Institute and State University, Blacksburg, Virginia

Gary Y.K. Chock, Martin and Chock, Honolulu, Hawaii
Anil K. Chopa, University of California, Berkeley, California
Mohammed M. Ettouney, Wedlinger Associates, New York, New York
Andrew Gayer, ABS Consulting, St. Louis, Missouri
S.K. Ghosh, S.K. Ghosh Associates, Palatine, Illinois
John D. Gilengerten, OSHPD, Facilities Development Division, Sacramento, California
Nathan Gould, ABS Consulting, St Louis, Missouri
Walter B. Grossman, Structural Consultant, Fairlawn, New Jersey
Ronald Hamburger, Simpson Gumpertz and Heger, San Francisco, California
Husein Hasan, Tennessee Valley Authority, Knoxville, Tennessee
William T. Holmes, Rutherford and Chekene Engineers, Oakland, California
John T. Hutton, Uzun and Case Engineers, Atlanta, Georgia
Marcelino Iglesias, Department of Community Development, Trenton, New Jersey
Robert I. Johnson, R.I. Johnson and Associates, Wheaton, Illinois
Leonard Joseph, Thornton-Tomasetti Engineers, New York, New York
Ghassem Khosrownia, U.S. Army Corps of Engineers, Sacramento, California
Uno Kula, Phoenix, Arizona
Philip Line, American Forest and Paper Association, Washington, D.C.
Joe Maffei, Rutherford and Chekene Consulting Engineers, Oakland, California
Scott E. Maxwell, Consulting Engineer, Ypsilanti, Michigan
Richard D. McConnell, Consultant, Springfield, Virginia
Vilas Mujumdar, National Science Foundation, Arlington, Virginia
Paul Murray, Structural Design Group, Nashville, Tennessee
Simin Naseeh, SEAoNC, San Francisco, California
Mark Pierepiekarz, MRP Engineering, Newcastle, Washington
David Pierson, ARW Engineers, Ogden, Utah
Andrei M. Reinhorn, State University of New York, Buffalo, New York
Frederick C. Schmitt, Consulting Civil Engineer, West Chester, Pennsylvania
Gary R. Searer, Wiss, Janney, Elstner Associates, Emeryville, California
John G. Shipp, EQE International, Irvine, California
Thomas, D. Skaggs, APA-The Engineered Wood Association, Tacoma, Washington
Itzhak Tepper, American Structural Engineers, Alexandria, Virginia
Jason Thompson, National Concrete Masonry Association, Herndon, Virginia
Fred M. Turner, Seismic Safety Commission, Sacramento, California

Michael Valley, Magnusson Klemencic, Seattle, Washington

Ed Wang, CH2M Hill, St. Louis, Missouri

Tom C. Xia, DCI Engineers, Bellevue, Washington

Howard Zee, ARUP, San Francisco, California

Technical Subcommittee 3, FOUNDATIONS AND GEOTECHNICAL CONSIDERATIONS

Chair

Maurice S. Power, Geomatrix Consultants, San Francisco, California

Members

Donald G. Anderson, CH2M Hill, Bellevue, Washington

David Bonowitz, Consultant, San Francisco, California

Roger D. Borchardt, U.S. Geological Survey, Menlo Park, California

Craig Comartin, Comartin-Reis, Stockton, California

Ricardo Dobry, Rensselaer Polytechnic Institute, Troy, New York

Tom H. Hale, California Office of Statewide Health Planning and Development, Sacramento, California

Jeffrey R. Keaton, AMEC Earth and Environmental, Anaheim, California

Geoffrey R. Martin, University of Southern California, Los Angeles, California

Farhang Ostadan, Bechtel Corporation, San Francisco, California

Edward E. Rinne, Kleinfelder, Oakland, California

Jonathan P. Stewart, University of California, Los Angeles

Corresponding Members

Susan W. Chang, Shannon & Wilson, Seattle, Washington

Paul L. Cloke, Science Applications International Corporation, Las Vegas, Nevada

C.B. Crouse, URS Corporation, Seattle, Washington

Husein Hasan, Tennessee Valley Authority, Knoxville, Tennessee

Neil M. Hawkins, University of Illinois, Urbana

Klaus H. Jacob, Lamont Doherty Earth Observatory of Columbia University, Palisades, New York

Dominic Kelly, Simpson Gumpertz & Heger, Waltham, Massachusetts

Jeffrey K. Kimball, U.S. Department of Energy, Germantown, Maryland

Cetin Soydemir, Geotechnical Services, Goffstown, New Hampshire

Steven A. Wendland, GeoSystems Engineering, Lenexa, Kansas

Tom C. Xia, DCI Engineers, Bellevue, Washington

T. Leslie Youd, Brigham Young University, Provo, Utah

Technical Subcommittee 4, CONCRETE STRUCTURES

Chair

Neil M. Hawkins, University of Illinois, Urbana

Members:

David E. Arndt, KPFF Consulting Engineers, Seattle, Washington

Ned M. Cleland, Blue Ridge Design, Winchester, Virginia

W. Gene Corley, Construction Technology Laboratories, Skokie, Illinois

S. K. Ghosh, S.K. Ghosh Associates, Northbrook, Illinois

David P. Gustafson, Concrete Reinforcing Steel Institute, Schaumburg, Illinois

Marcelino Iglesias, Department of Community Development, Trenton, New Jersey

H. S. Lew, National Institute of Standards and Technology, Gaithersburg, Maryland

Rene W. Luft, Simpson Gumpertz & Heger, San Francisco, California

Joe Maffei, Rutherford & Chekene Consulting Engineers, Oakland, California

Joseph J. Messersmith, Jr., Portland Cement Association, Rockville, Virginia

Jack P. Moehle, Pacific Earthquake Engineering Research Center, Richmond, California

Richard Wollmershauser, Hilti, Tulsa, Oklahoma

Sharon L. Wood, University of Texas, Austin

Corresponding Members:

Leo Argiris, Arup & Partners, New York, New York

Nathan Gould, ABS Consulting, St. Louis, Missouri

Mervyn Kowalsky, North Carolina State University, Raleigh, North Carolina

Scott E. Maxwell, Consulting Engineer, Ypsilanti, Michigan

Antonio Nanni, University of Missouri, Rolla, Missouri

John F. Silva, Hilti, San Rafael, California

Scott Tinker, EQE International, Seattle, Washington

Tom C. Xia, DCI Engineers, Bellvue, Washington

Technical Subcommittee 5, MASONRY STRUCTURES

Chair

Daniel Shapiro, SOH and Associates, Structural Engineers, San Francisco, California

Members

Daniel P. Abrams, University of Illinois MAE Center, Urbana

Randall P. Bernhardt, Burns & McDonnell, St. Louis, Missouri

J. Gregg Borchelt, Brick Industry Association, Reston, Virginia

Robert Chittendon, DSA, Granite Bay, California

Richard E. Klingner, University of Texas, Austin

Vilas Mujumdar, National Science Foundation, Arlington, Virginia

Max L. Porter, Department of Civil Engineering, Iowa State University, Ames

James R. Tauby, Mason Industries, Smithtown, New York

Jason J. Thompson, National Concrete Masonry Association, Herndon, Virginia

Terence A. Weigel, Department of Civil Engineering, University of Louisville, Kentucky

Corresponding Members

Dean D. Brown, Interstate Brick Company, West Jordan, Utah

Thomas A. Gangel, Wallace Engineering Structural Consultants, Tulsa, Oklahoma

S.K. Ghosh, S.K. Ghosh Associates, Palatine, Illinois

Marcelino Iglesias, Department of Community Development, Trenton, New Jersey

Eric N. Johnson, Brick Association of the Carolinas, Charlotte, North Carolina

Dilip Khatri, Khatri International, Pasadena, California

Laura Larson, Durant, Au Clair, Wisconsin

Scott Maxwell, Consulting Engineer, Ypsilanti, Michigan

Richard Silva, National Park Service, Lakewood, Colorado

Simin Naseeh, Structural Engineers Association of Northern California, San Francisco, California

Arturo E. Schultz, University of Minnesota, Minneapolis

John Tawresey, KPFF Consulting Engineers, Seattle, Washington

Diane Throop, Consultant, Cincinnati, Ohio

Technical Subcommittee 6, STEEL STRUCTURES

Chair

James O. Malley, Degenkolb Engineers, San Francisco, California

Members

Michel Bruneau, MCEER, State University of New York, Buffalo

Richard M. Drake, J.S. Dyer & Associates, Irvine, California

Harry W. Martin, American Iron and Steel Institute, Auburn, California

Clarkson W. Pinkham, S. B. Barnes Associates, Los Angeles, California

C. Mark Saunders, Rutherford and Chekene, San Francisco, California

W. Lee Shoemaker, Metal Building Manufacturers Association, Cleveland, Ohio

Bozidar Stojadinovic, University of California, Berkeley

Kurt D. Swensson, KSI Structural Engineers, Atlanta, Georgia

Chia-Ming Uang, University of California

Corresponding Members:

Leo Argiris, Arup & Partners, New York, New York

Hassan Astaneh, University of California at Berkeley

Michael Cochran, Brian L. Cochran Associates, Los Angeles, California

Andrew Gayer, ABS Consulting, St. Louis, Missouri

Subhash C. Goel, University of Michigan, Ann Arbor

Nathan Gould, ABS Consulting, St. Louis, Missouri

John L. Gross, National Institute of Standards and Technology, Gaithersburg, Maryland

Y. Henry Huang, Los Angeles County Department of Public Works, Alhambra, California

Marcelino Iglesias, Department of Community Development, Trenton, New Jersey

Ghassem Khosrownia, U.S. Army Corps of Engineers, Sacramento, California

Cynthia Duncan, AISC, Chicago, Illinois

Terry R. Lundeen, Coughlin Porter Lundeen, Seattle, Washington

Robert T. Lyons, Brandow & Johnston Associates, Los Angeles, California

Paul C. Perrin, Burgess & Niple, Ltd., Cincinnati, Ohio

David L. Pierson, ARW Engineers, Ogden, Utah

Steven M. Thomas, Butler Construction, Kansas City, Missouri

James R. Thomas, Delich, Roth & Goodwillie, P.A., Kansas City, Missouri

Tom C. Xia, DCI Engineers, Bellvue, Washington

Technical Subcommittee 7, WOOD STRUCTURES

Chair

Philip Line, American Forest and Paper Association, Washington, D.C.

Members

Kelly Cobeen, Cobeen & Associates Structural Engineering, Lafayette, California

Vladimir Kochkin, National Association of Home Builders Research Center, Upper Marlboro, Maryland

J. Daniel Dolan, Washington State University, Pullman, Washington

Erol Karacabeyli, Forintek Canada Corporation, Vancouver, British Columbia, Canada

James A. Mahaney, Wiss, Janney, Elstner Associates, Emeryville, California

Frank K. H. Park, Guilford County Planning and Development, Greensboro, North Carolina

Steven E. Pryor, Simpson Strong-Tie, Dublin, California

James E. Russell, Consultant, Concord, California

Thomas D. Skaggs, APA - The Engineered Wood Association, Tacoma, Washington

Chuck Williams, CWA Consultants, Sammamish, Washington

Corresponding Members

Philip R. Brazil, Reid Middleton, Everett, Washington

Kevin C. K. Cheung, Western Wood Products Association, Portland, Oregon

John M. Coil, Thornton-Tomasetti, Cole & Walsh, Tustin, California

Jay Crandell, Applied Residential Engineering Associates, West River, Maryland

Thomas M. Corcoran, Carter-Burgess, Kirkland, Washington

Andre Filiatrault, University of California, San Diego

Robert S. George, Architect, San Bruno, California

Greg Gilda, EQE International, Seattle, Washington

Robert W. Glowinski, American Forest and Paper Association, Washington, DC

Zeno Martin, APA- The Engineered Wood Association, Tacoma, Washington

Gary L. Mochizuki, Structural Solutions, Walnut Creek, California

Rawn Nelson, R.F. Nelson and Associates, Hermosa Beach, California

Douglas Rammer, USDA Forest Products Laboratory, Madison, Wisconsin

Mike Rhodebeck, USP Lumber Connectors, Gambier, Ohio

Alan Robinson, Tuan and Robinson Structural Engineers, San Francisco, California

David V. Rosowsky, Oregon State University, Corvallis, Oregon

Stephen P. Schneider, Kramer-Gehlen and Associates, Vancouver, Washington

Douglas M. Smith, City of Charleston, South Carolina

Victor L. Taugher, Taugher and Associates, Castro Valley, California

David P. Tyree, American Forest and Paper Association, Colorado Springs, Colorado

Dennis S. Wish, Professional Engineer, La Quinta, California

Edwin G. Zacher, H.J. Brunnier and Associates, San Francisco, California

**Technical Subcommittee 8, MECHANICAL/ELECTRICAL SYSTEMS AND BUILDING
EQUIPMENT AND ARCHITECTURAL ELEMENTS**

Chair

John D. Gillengerten, Office of Statewide Health Planning and Development, Sacramento, California

Members

George Antaki, WSRC – Savannah Site, Aiken, South Carolina

Robert E. Bachman, Consulting Structural Engineer, Sacramento, California

Richard A. Behr, Pennsylvania State University, University Park, Pennsylvania

Russell Fleming, National Fire Sprinkler Association, Patterson, New York

Ronald W. Haupt, Pressure Piping Engineering Associates, Foster City, California

Y. Henry Huang, Los Angeles County Department of Public Works, Alhambra, California

Pat Lama, Mason Industries, Hauppauge, New York

John V. Loscheider, Loscheider Engineering Company, Renton, Washington

David A. Sheppard, Consulting Structural Engineer, Sonoma, California

John F. Silva, Hilti, San Rafael, California

William W. Stewart, Stewart-Schaberg/Architects, Clayton, Missouri

Corresponding Members

Leo Argiris, Arup & Partners, New York, New York

Victor D. Azzi, Rack Manufacturers Institute, Rye, New Hampshire

Antonio Braga, FM Global, Woodland Hills, California

James A. Carlson, Fort Calhoun Station, Fort Calhoun, Nebraska

Paul J. Carrafa, Property Maintenance Specialists, Willingboro, New Jersey

Christian Dubay, National Fire Protection Association, Quincy, Massachusetts

Mohammed M. Ettouney, Weidlinger Associates, New York, New York

Joseph R. Hetzel, Door & Access Systems Manufacturers, Cleveland, Ohio

John T. Hutton, Lockwood Greene Engineers, Atlanta, Georgia

Marcelino Iglesias, Department of Community Development, Trenton, New Jersey

Brian Kehoe, Consultant, Emeryville, California

Paul Meisel, Kinetics Noise Control, Dublin, Ohio

Antonio Nanni, University of Missouri, Rolla

Richard J. Phillips, Martin & HBL, Los Angeles, California

Mark R. Pierepiekarz, MRP Engineering, Newcastle, Washington

John "Jack" Prosek, Turner Construction Company, San Jose, California

Robert Simmons, Amber/Booth, Houston, Texas

Jean Smith, Schindler Elevator Corporation, Morristown, New Jersey

William Staehlin, Division of State Architect, Sacramento, California

Victoria Valentine, National Fire Sprinkler Association, Patterson, New York

Michael E. Werner, County of St. Louis, Missouri

Richard Wollmershauser, Hilti, Tulsa, Oklahoma

Maryann Phipps, ESTRUCTURE, El Cerrito, California

Technical Subcommittee 9, QUALITY ASSURANCE

Chair

Douglas M. Smits, City of Charleston, South Carolina

Members

Mark Kluver, Portland Cement Association, San Ramon, California

John Loscheider, Loscheider Engineering Company, Renton, Washington

Jim W. Sealy, Jim W. Sealy/Architect/Consultant, Dallas, Texas

Charles A. Spitz, Architect/Planner/Code Consultant, Wall, New Jersey

Corresponding Members

Michael Constantinou, State University of New York, Buffalo

Neil Hawkins, Consultant, Clyde Hill, Washington

Roberto T. Leon, Georgia Institute of Technology, Atlanta, Georgia

Philip Line, American Forest and Paper Association, Washington, DC

James O. Malley, Degenkolb Engineers, San Francisco, California

R. William McNealy, McNealy-Burnberry Engineering, St. Louis, Missouri

Vilas Mujumdar, National Science Foundation, Arlington, Virginia

Daniel Shapiro, SOHA Engineers, San Francisco, California

Ed Sutton, National Association of Home Builders, Washington, DC

James R. Thomas, Delich, Roth and Goodwillie, P.A., Kansas City, Missouri

Fred M. Turner, California Seismic Safety Commission, Sacramento, California

Technical Subcommittee 10, RESIDENTIAL AND LOW RISE STRUCTURES

Chair

J. Daniel Dolan, Washington State University, Pullman, Washington

Members

Mark Caldwell, Apex Engineering, Calvert City, Kentucky

Chip Clark, Brick Industry Association, Reston, Virginia

James R. Harris, J.R. Harris & Company, Denver, Colorado

Eric N. Johnson, Brick Association of the Carolinas, Charlotte, North Carolina

Joseph J. Messersmith, Portland Cement Association, Rockville, Virginia

Jim W. Sealy, Architect, Dallas, Texas

Lee Shoemaker, Metal Building Manufacturers Association, Cleveland, Ohio

David P. Tyree, American Forest and Paper Association, Colorado Springs, Colorado

Terence A. Weigel, University of Louisville, Kentucky

Robert J. Wills, American Iron & Steel Institute, Birmingham, Alabama

Sharon, L. Wood, University of Texas, Austin

Corresponding Members

S.K. Ghosh, S.K. Ghosh Associates, Palatine, Illinois

Wassem Khan, Brick Industry Association, Reston, Virginia

Ed Sutton, National Association of Home Builders, Washington, DC

Technical Subcommittee 11, COMPOSITE STEEL AND CONCRETE STRUCTURES

Chair

Roberto T. Leon, School of Civil and Environmental Engineering, Georgia Institute of Technology, Atlanta

Members

Jerome F. Hajjar, University of Minnesota, Minneapolis

Kevin LeSmith, Magnusson Klemencic, Seattle, Washington

Clarkson W. Pinkham, S. B. Barnes Associates, Los Angeles, California

Bahram M. Sharooz, University of Cincinnati, Ohio

Kurt D. Swenson, KSI Structural Engineers, Atlanta, Georgia

Corresponding Members

Scott A. Civjan, University of Massachusetts, Amherst

Greg Deierlein, Stanford University, Palo Alto, California

Subhash Goel, University of Michigan, Ann Arbor

Larry Griffis, Walter P. Moore and Associates, Austin, Texas

Neil Hawkins, Consultant, Clyde Hill, Washington

Technical Subcommittee 12, BASE ISOLATION AND ENERGY DISSIPATION

Chair

Michael Constantinou, Department of Civil, Structural and Environmental Engineering, University at Buffalo, State University of New York, Buffalo, New York

Members

Tom H. Hale, Office of Statewide Health Planning and Development, Sacramento, California

Robert D. Hanson, Federal Emergency Management Agency, Pasadena, California

Saif Hussain, SHA Coffman Engineers, Encino, California

Martin W. Johnson, ABS Consulting, Irvine, California

Charles Kircher, Charles Kircher & Associates Consulting Engineers, Palo Alto, California

Kit Miyamoto, Marr Chatter & Miyamoto, West Sacramento, California

Andrew Whittaker, Department of Civil, Structural and Environmental Engineering, University at Buffalo, State University of New York, Buffalo, New York

Corresponding Members

Ian Aiken, Seismic Isolation Engineering, Piedmont, California

Amarnath Kasalanati, DIS, Inc., Lafayette, California

Wenshen Pong, San Francisco State University, California

Mark Sinclair, Degenkolb Engineers, San Francisco, California

John Stewart, Rimkus Consulting Group, Atlanta, Georgia

Andrew W. Taylor, KPFF Consulting Engineers, Seattle, Washington

Jack Wiggins, EQE International, Seattle, Washington

Technical Subcommittee 13, NONBUILDING STRUCTURES

Chair

Stephen W. Meier, Tank Industry Consultants, Indianapolis, Indiana

Members

Wafic T. Ayoub, Specialized Engineering Services, Overland Park, Kansas

Robert E. Bachman, Consulting Structural Engineer, Sacramento, California

Richard M Drake, J.S. Dyer & Associates, Irvine, California

Robert M. Ebeling, U.S. Army Engineer Research and Development Center, Vicksburg, Mississippi

Martin L. Eskijian, California State Land Commission, Long Beach, California

Douglas G. Honegger, D.G. Honegger Consulting, Arroyo Grande, California

John T. Hutton, Uzun & Case Engineers, Atlanta, Georgia

Gayle S. Johnson, Han-Padron Associates, Oakland, California

Leon Kempner, Jr., Bonneville Power Administration, Vancouver, Washington

Nicholas A. Legatos, Preload, Hauppauge, New York

Theodore, C. Lemoff, National Fire Protection Association International, Quincy, Massachusetts

Denis Radecki, Hamon Custodis, Brazil, Indiana

Carl Rivkin, National Fire Protection Association International, Quincy, Massachusetts

Harold Sprague, Black and Veatch Special Projects Corporation, Overland Park, Kansas

Corresponding Members

David K. Adams, Lane Engineers, Tulare, California

Scott Ashford, University of California, San Diego

Victor D. Azzi, Rack Manufacturers Institute, Rye, New Hampshire

Pete Carrato, Bechtel Corporation, Frederick, Maryland

Thomas Dahlgren, Ben E. Gerwick, San Francisco, California
John Ferrito, Consultant, Ventura, California
Henry Fong, Port of Long Beach, California
Donita K. Fredricks, Chicago Bridge and Iron, Clive, Iowa
Charles S. Hanskat, Hanskat and Associates, San Diego, California
Husein Hasan, Tennessee Valley Authority, Knoxville, Tennessee
Frank J. Hsiu, Chevron Texaco Research and Technology Company, Richmond, California
Jagadish Joshi, Westinghouse, Georgia
John V. Loscheider, Loscheider Engineering Company, Renton, Washington
Praveen K. Malhotra, Factory Mutual Research, Norwood, Massachusetts
Sanj Malhuste, Bechtel Corporation, Frederick, Maryland
Robert J. Masterson, RJM Associates, Fall River, Massachusetts
Anil Misra, University of Missouri, Kansas City
Douglas J. Nyman, D.J. Nyman & Associates, Houston, Texas
Rolf Pawski, Landmark Structures, Wheaton, Illinois
Bob Porthouse, Chimney Consultants, West Lebanon, New Hampshire
Anshel J. Schiff, Stanford University, Stanford, California
Jerry Serventi, Port of Oakland, California
John D. Stevenson, Stevenson & Associates, Cleveland, Ohio
Harry E. Stewart, Cornell University, Ithaca, New York
Warren Stewart, Han-Padron Associates, Long Beach, California
Eric K. Thorkildsen, Collins Engineering, East Greenbush, New York
Stuart D. Werner, Seismic Systems & Engineering Consultants, Oakland, California
Peter Yin, Port of Los Angeles, San Pedro, California

BSSC SIMPLIFIED DESIGN TASK GROUP

Chair

William T. Holmes, Rutherford & Chekene, Oakland, California

Members

Gary Y.K. Chock, Martin and Chock, Honolulu, Hawaii
Ronald O. Hamburger, Simpson Gumpertz and Heger, San Francisco, California
James R. Harris, J.R. Harris & Company, Denver, Colorado
John D. Hooper, Magnusson Klemencic, Seattle, Washington
Richard J. Phillips, Martin & HBL, Los Angeles, California

**REPRESENTATIVES OF BSSC MEMBER ORGANIZATIONS
AND THEIR ALTERNATES**

AFL-CIO Building and Construction Trades Department

Representative Pete Stafford, Center to Protect Workers' Rights, Washington, D.C.

Alternate None on Record

American Concrete Institute

Representative Shuaib H. Ahmed, American Concrete Institute, Farmington Hills, Michigan

Alternate None on Record

American Consulting Engineers Council

Representative Gregg E. Brandow, Brandow and Johnston Associates, Los Angeles, California

Alternate Edward Bajer, American Council of Engineering Companies, Washington, D.C.

American Forest and Paper Association

Representative David P. Tyree, American Forest and Paper Association, Colorado Springs, Colorado

Alternate Bradford K. Douglas, American Forest and Paper Association, Washington, D.C.

American Institute of Architects

Representative Charles A. Spitz, Architect/Planner/Code Consultant, Wall, New Jersey

Alternate Perry A. Haviland, Haviland Associates Architects, Oakland, California

American Institute of Steel Construction

Representative Charles J. Carter, American Institute of Steel Construction, Chicago, Illinois

Alternate Louis F. Geschwinder, American Institute of Steel Construction, Chicago, Illinois

American Iron and Steel Institute

Representative Harry W. Martin, American Iron and Steel Institute, Auburn, California

Alternate None on Record

American Society of Civil Engineers

Representative James A. Rossberg, American Society of Civil Engineers, Reston, Virginia
Alternate Douglas E. Honegger, Consultant, Arroyo Grande, California

American Society of Civil Engineers – Kansas City Chapter

Representative F. Alan Wiley, Black and Veatch, Overland Park, Kansas
Alternate Thomas Heausler, Heausler Structural Engineers, Kansas City, Missouri

American Society of Heating, Refrigeration, and Air-Conditioning Engineers

Representative William Staehlin, Office of State Health Planning and Development, Sacramento, California
Alternate Bruce D. Hunn, American Society of Heating, Refrigeration, and Air-Conditioning Engineers

American Society of Mechanical Engineers

Representative Ronald W. Haupt, Pressure Piping Engineering Associates, Inc., Foster City, California
Alternate Timothy M. Adams, Stevenson & Associates, Cleveland, Ohio

American Welding Society

Representative John Gayler, American Welding Society, Miami, Florida
Alternate William R. Oates, American Welding Society, Miami, Florida

APA - The Engineered Wood Association

Representative Thomas D. Skaggs, APA - The Engineered Wood Association, Tacoma, Washington
Alternate Zeno A. Martin, APA - The Engineered Wood Association, Tacoma, Washington

Applied Technology Council

Representative Christopher Rojahn, Applied Technology Council, Redwood City, California
Alternate Edwin T. Dean, Nishkian Dean, Portland, Oregon

Associated General Contractors of America

Representative Jim Rinner, Kitchell CEM, Sacramento, California
Alternate Dirk Haire, Haire Logan, LLP, Annapolis, Maryland

Association of Engineering Geologists

Representative Ellis Krinitzsky, U.S. Army Corps of Engineers, Vicksburg, Mississippi

Alternate Patrick J. Barosh, Patrick J. Barosh and Associates, Bristol, Rhode Island

Association of Major City Building Officials

Representative Andrew A. Adelman, City of Los Angeles, California

Alternate Steve Ikkanda, City of Los Angeles, California

Brick Industry Association

Representative J. Gregg Borchelt, Brick Industry Association, Reston, Virginia

Alternate Wassem Khan, Brick Industry Association, Reston, Virginia

Building Owners and Managers Association International

Representative Ron Burton, Building Owners and Managers Association International, Washington, D.C.

California Geotechnical Engineers Association

Representative Alan Kropp, Alan Kropp and Associates, Berkeley, California

Alternate Matt Rogers, Zeiser Kling Consultants, Inc., Santa Ana, California

California Seismic Safety Commission

Representative Fred Turner, Seismic Safety Commission, Sacramento, California

Canadian National Committee on Earthquake Engineering

Representative R.H. Devall, Canadian National Committee on Earthquake Engineering, Vancouver, British Columbia, Canada

Alternate Cathleen Taraschuk, National Research Council of Canada, Ottawa, Ontario, Canada

Concrete Masonry Association of California and Nevada

Representative Paul D. Bambauer, Concrete Masonry Association of California and Nevada, Citrus Heights, California

Alternate None on Record

Concrete Reinforcing Steel Institute

Representative David P. Gustafson, Concrete Reinforcing Steel Institute, Schaumburg, Illinois
Alternate Scott R. Humphries, Concrete Reinforcing Steel Institute, Schaumburg, Illinois

California Division of the State Architect

Representative Dennis Bellet, Division of State Architect, Sacramento, California
Alternate Howard “Chip” Smith, Jr., Division of State Architect, Sacramento, California

Earthquake Engineering Research Institute

Representative David Bonneville, Degenkolb Engineers, San Francisco, California
Alternate F. Robert Preece, Consultant, San Francisco, California

General Services Administration (9PCT)

Representative Bela I. Palfalvi, General Services Administration 9PCT, San Francisco, California
Alternate Catherine K. Lee, General Services Administration 9 PCT, San Francisco, California

Hawaii State Earthquake Advisory Board

Representative Gary Y. K. Chock, Martin and Chock, Inc., Honolulu, Hawaii
Alternate Paul Okubo, Hawaii State Earthquake Advisory Board, Honolulu, Hawaii

Institute for Business and Home Safety

Representative Jeffrey Sciaudone, Institute for Business and Home Safety, Tampa Florida
Alternate None on Record

Interagency Committee on Seismic Safety in Construction

Representative H. S. Lew, National Institute of Standards and Technology, Gaithersburg, Maryland
Alternate Shyam Sunder, National Institute of Standards and Technology, Gaithersburg, Maryland

International Code Council

Representative Tom Frost, International Code Council, Country Club Hills, Illinois
Alternate None on Record

International Masonry Institute

Representative Diane Throop, Consultant, Cincinnati, Ohio

Alternate Richard Filloramo, International Masonry Institute, Glastonbury, Connecticut

Masonry Institute of America

Representative John Chrysler, Masonry Institute of America, Torrance, California

Metal Building Manufacturers Association

Representative W. Lee Shoemaker, Metal Building Manufacturers Association, Cleveland, Ohio

Alternate Joe N. Nunnery, VP Buildings, Memphis, Tennessee

Mid-America Earthquake Center

Representative Daniel P. Abrams, Mid-America Earthquake Center, University of Illinois, Urbana

Alternate Amr Elnashai, Mid-America Earthquake Center, University of Illinois, Urbana

National Association of Home Builders

Representative Joseph Knarich, National Association of Home Builders, Washington, D.C.

Alternate None on Record

National Concrete Masonry Association

Representative Jason J. Thompson, National Concrete Masonry Association, Herndon, Virginia

Alternate Jeff Greenwald, National Concrete Masonry Association, Herndon, Virginia

National Conference of States on Building Codes and Standards

Representative Richard T. Conrad, Division of State Architect, Sacramento, California

Alternate Robert C. Wible, National Conference of States on Building Codes and Standards, Herndon, Virginia

National Council of Structural Engineers Associations

Representative Howard Simpson, Simpson, Gumpertz and Heger, Arlington, Massachusetts

Alternate W. Gene Corley, Construction Technology Laboratories, Skokie, Illinois

National Elevator Industry, Inc.

Representative George A. Kappenhagen, Schindler Elevator Corporation, Morristown, New Jersey
Alternate Jean Smith, Schindler Elevator Corporation, Morristown, New Jersey

National Fire Sprinkler Association

Representative Russell P. Fleming, National Fire Sprinkler Association, Patterson, New York
Alternate Victoria Valentine, National Fire Sprinkler Association, Patterson, New York

National Institute of Building Sciences

Representative Henry L. Green, State of Michigan Department of Consumer and Industry Services, Okemos, Michigan
Alternate Gerald H. Jones, Consultant, Kansas City, Missouri

National Ready Mixed Concrete Association

Representative George Muste, National Ready Mixed Concrete Association, Silver Spring, Maryland
Alternate Colin L. Lobo, National Ready Mixed Concrete Association, Silver Spring, Maryland

Portland Cement Association

Representative Joseph J. Messersmith, Jr., Portland Cement Association, Rockville, Virginia
Alternate S. K. Ghosh, S. K. Ghosh Associates, Inc., Palatine, Illinois

Precast/Prestressed Concrete Institute

Representative Jason J. Krohn, Precast/Prestressed Concrete Institute, Chicago, Illinois
Alternate David A. Sheppard, Consulting Structural Engineer, Sonora, California

Rack Manufacturers Institute

Representative Victor Azzi, Rack Manufacturers Institute, Rye, New Hampshire
Alternate John Nofsinger, Rack Manufacturers Institute, Charlotte, North Carolina

Santa Clara University

Representative Reynaud Serrette, Santa Clara University, Santa Clara, California

Alternate Wendy Taniwangsa, Santa Clara University, Santa Clara, California

Steel Deck Institute, Inc.

Representative Steven A. Roehrig, Steel Deck Institute, Algonquin, Illinois

Alternate Walter Schultz, Nucor Research & Development, Norfolk, Nebraska

Structural Engineers Association of California

Representative James O. Malley, Degenkolb Engineers, San Francisco, California

Alternate Allan Porush, Dames & Moore, Los Angeles, California

Structural Engineers Association of Central California

Representative Dennis Bellet, Structural Engineers Association of California, Fair Oaks, California

Alternate Tom H. Hale, Office of Statewide Health Planning and Development, Sacramento, California

Structural Engineers Association of Colorado

Representative James R. Harris, J. R. Harris and Company, Denver, Colorado

Alternate Dave Houdeshell, JVA, Incorporated, Boulder, Colorado

Structural Engineers Association of Illinois

Representative W. Gene Corley, Construction Technology Laboratories, Skokie, Illinois

Alternate None on Record

Structural Engineers Association of Kentucky

Representative Mark A. Caldwell, Apex Engineering, Calvert City, Kentucky

Alternate Jiin Long Huang, Consultant, Lexington, Kentucky

Structural Engineers Association of Northern California

Representative Simin Naseeh, Structural Engineers Association of Northern California, San Francisco, California

Alternate Edwin G. Zacher, H. J. Brunnier Associates, San Francisco, California

Structural Engineers Association of Oregon

Representative Michael R. Hagerty, Consulting Engineer, Portland, Oregon

Alternate Joseph C. Gehlen, Kramer Gehlen Associates, inc., Vancouver, Washington

Structural Engineers Association of San Diego

Representative Chris Kamp, Stedman Dyson Structural Engineers, San Diego, California

Alternate None on Record

Structural Engineers Association of Southern California

Representative Richard L. Hess, Hess Engineering, Los Alamitos, California

Alternate Robert T. Lyons, Brandow & Johnston Associates, Los Angeles, California

Structural Engineers Association of Texas

Representative Joseph Kallaby, OSI, Houston, Texas

Alternate Michael D. Engelhardt, University of Texas, Austin

Structural Engineers Association of Utah

Representative A. Parry Brown, Reaveley Engineers and Associates, Salt Lake City, Utah

Alternate David L. Pierson, ARW Engineers, Ogden, Utah

Structural Engineers Association of Washington

Representative Doug Wilson, Reid Middleton, Inc., Everett, Washington

Alternate Michael Valley, Magnusson Klemencic, Seattle, Washington

The Masonry Society

Representative Arturo E. Schultz, University of Minnesota, Minneapolis

U.S. Army Construction & Engineering Research Laboratory

Representative John R. Hayes, US Army CERL, Champaign, Illinois

Alternate Steven C. Sweeney, US Army CERL, Champaign, Illinois

Western States Clay Products Association

Representative Jeff I. Elder, Western State Clay Products Association, West Jordan, Utah

Alternate None on Record

Western States Structural Engineers Association

Representative Greg Shea, Moffat, Nichol and Bonney, Inc., Portland, Oregon

Alternate William T. Rafferty, Structural Design North, Spokane, Washington

Wire Reinforcement Institute, Inc.

Representative Roy H. Reiterman, Roy H. Reiterman, PE & Associates, Troy, Michigan

Alternate Robert C. Richardson, Consultant, Sun Lakes, Arizona

**REPRESENTATIVES OF BSSC AFFILIATE MEMBERS
AND THEIR ALTERNATES**

Bay Area Structural, Inc.

Representative David Benaroya Helfant, Bay Area Structural, Inc., Oakland, California
Alternate None on Record

Building Technology, Incorporated

Representative David B. Hattis, Building Technology, Inc., Silver Spring, Maryland
Alternate None on Record

City of Hayward

Representative Paul O. Johnson, City of Hayward, California
Alternate None on Record

Felten Engineering Group

Representative Greg Felten, Felten Engineering Group, Phoenix, Arizona
Alternate Ken Mulder, Felten Engineering Group, Phoenix, Arizona

H & H Group, Inc.

Representative Les. L. Hegyi, H&H Group, Inc., McLean, Virginia
Alternate None on Record

HLM Design

Representative Philip J. Antis, Burns Engineering, McLean, Virginia
Alternate Shawn M. Elliott, HLM Design, Bethesda, Maryland

LaPay Consulting, Inc.

Representative William S. LaPay, LaPay Consulting, Inc., Export, Pennsylvania
Alternate None on Record

Square D Company

Representative Philip J. Caldwell, Square D Company, Seneca, South Carolina
Alternate Jeffrey Gatscher, Square D Company, Nashville, Tennessee

Steel Joist Institute

Representative Robert R. Hackworth, Steel Joist Institute, Myrtle Beach, South Carolina

Alternate None on Record

Vibration Mountings and Controls

Representative John P. Giuliano, Vibration Mountings and Controls, Bloomingdale, New Jersey

Alternate Rajendra Prasad, Vibration Mountings and Controls, Bloomingdale, New Jersey

This page is intentionally left blank.



of the National Institute of Building Sciences

*Program on
Improved Seismic Safety
Provisions*

2003 Edition

**RECOMMENDED PROVISIONS
FOR SEISMIC REGULATIONS
FOR NEW BUILDINGS
AND OTHER STRUCTURES (FEMA 450)**

Part 2: Commentary

The **Building Seismic Safety Council (BSSC)** was established in 1979 under the auspices of the National Institute of Building Sciences as an entirely new type of instrument for dealing with the complex regulatory, technical, social, and economic issues involved in developing and promulgating building earthquake hazard mitigation regulatory provisions that are national in scope. By bringing together in the BSSC all of the needed expertise and all relevant public and private interests, it was believed that issues related to the seismic safety of the built environment could be resolved and jurisdictional problems overcome through authoritative guidance and assistance backed by a broad consensus.

The BSSC is an independent, voluntary membership body representing a wide variety of building community interests. Its fundamental purpose is to enhance public safety by providing a national forum that fosters improved seismic safety provisions for use by the building community in the planning, design, construction, regulation, and utilization of buildings.

See the back of this *Commentary* volume for a full description of BSSC activities.

2003 BSSC BOARD OF DIRECTION

Chairman	Charles Thornton, Chairman/Principal, Thornton-Tomasetti Group, Inc., New York, New York
Vice Chairman	David Bonneville, Degenkolb Engineers, San Francisco, California
Secretary	Charles Carter, Chief Structural Engineer, American Institute of Steel Construction, Chicago, Illinois
Ex-Officio	William W. Stewart, Stewart-Schaberg Architects, Clayton, Missouri (representing the American Institute of Architects)
Members	J. Gregg Borchelt, Vice President, Brick Industry Association, Reston, Virginia Edwin Dean, Nishkian Dean, Portland, Oregon Bradford K. Douglas, Director of Engineering, American Forest and Paper Association, Washington, D.C. Henry Green, Executive Director, Bureau of Construction Codes and Fire Safety, State of Michigan, Department of Labor and Economic Growth, Lansing, Michigan (representing the National Institute of Building Sciences) H.S. Lew, Senior Research Engineer, National Institute of Standards and Technology, Gaithersburg, Maryland (representing Interagency Committee on Seismic Safety in Construction) Joseph Messersmith, Coordinating Manager, Regional Code Services, Portland Cement Association, Rockville, Virginia (representing the Portland Cement Association) Jim Rinner, Project Manager II, Kitchell CEM, Sacramento, California James Rossberg, Manager, Technical Activities for the Structural Engineering Institute, American Society of Civil Engineers, Reston Virginia Jeffery Sciadone, Associate Director, of Engineering, Institute of Business and Home Safety, Tampa, Florida W. Lee Shoemaker, Director, Engineering and Research, Metal Building Manufacturers Association, Cleveland, Ohio Howard Simpson, Simpson Gumpertz and Heger, Arlington, Massachusetts (representing National Council of Structural Engineers Associations) Charles A. Spitz, Architect/Planner/Code Consultant, Wall New Jersey (representing the American Institute of Architects)
BSSC STAFF	Claret M. Heider, Vice President for BSSC Programs Bernard F. Murphy, Director, Special Projects Carita Tanner, Communications/Public Relations Manager Patricia Blasi, Administrative Assistant

BSSC Program on Improved Seismic Safety Provisions

NEHRP RECOMMENDED PROVISIONS
(National Earthquake Hazards Reduction Program)
FOR SEISMIC REGULATIONS
FOR NEW BUILDINGS AND
OTHER STRUCTURES (FEMA 450)

2003 EDITION

Part 2: COMMENTARY

Prepared by the
Building Seismic Safety Council
for the
Federal Emergency Management Agency

BUILDING SEISMIC SAFETY COUNCIL
NATIONAL INSTITUTE OF BUILDING SCIENCES
Washington, D.C.
2004

NOTICE: Any opinions, findings, conclusions, or recommendations expressed in this publication do not necessarily reflect the views of the Federal Emergency Management Agency. Additionally, neither FEMA nor any of its employees make any warranty, expressed or implied, nor assume any legal liability or responsibility for the accuracy, completeness, or usefulness of any information, product, or process included in this publication.

This report was prepared under Contract EMW-2001-CO-0269 between the Federal Emergency Management Agency and the National Institute of Building Sciences.

Building Seismic Safety Council activities and products are described at the end of this report. For further information, see the Council website (www.bssconline.org) or contact the Building Seismic Safety Council, 1090 Vermont, Avenue, N.W., Suite 700, Washington, D.C. 20005; phone 202-289-7800; fax 202-289-1092; e-mail bssc@nibs.org.

Copies of this report on CD Rom may be obtained from the FEMA Publication Distribution Facility at 1-800-480-2520. Limited paper copies also will be available. The report can also be downloaded in pdf form from the BSSC website at www.bssconline.org.

The National Institute of Building Sciences and its Building Seismic Safety Council caution users of these *Provisions* documents to be alert to patent and copyright concerns especially when applying prescriptive requirements.

CONTENTS

Chapter 1 GENERAL PROVISIONS	1
1.1 GENERAL	1
1.1.1 Purpose	1
1.2 SEISMIC USE GROUPS	4
1.2.5 Seismic Use group III structure access protection	8
1.3 OCCUPANCY IMPORTANCE FACTOR.....	8
1.4 SEISMIC DESIGN CATEGORY	8
1.4.2 Site limitation for Seismic Design Categories E and F	10
1.5 SEISMIC DESIGN CATEGORY A	10
1.5.1 Lateral forces	10
1.5.2 Connections.....	11
1.5.3 Anchorage of concrete or masonry walls	11
Chapter 2 QUALITY ASSURANCE	13
2.1 GENERAL	13
2.1.1 Scope.....	13
2.2 GENERAL REQUIREMENTS	14
2.3 SPECIAL INSPECTION	15
2.3.9 Architectural components	15
2.3.10 Mechanical and electrical components.....	15
2.4 TESTING	16
2.4.5 Mechanical and electrical equipment.....	16
2.5 STRUCTURAL OBSERVATIONS	16
2.6 REPORTING AND COMPLIANCE PROCEDURES	16
Chapter 3 GROUND MOTION	17
3.1 GENERAL	17
3.1.3 Definitions.....	17
3.2 GENERAL REQUIREMENTS	18
3.2.2 Procedure selection	18
3.3 GENERAL PROCEDURE.....	18
3.3.2 Site coefficients and adjusted acceleration parameters	19
3.3.4 Design response spectrum.....	26
3.4 SITE SPECIFIC PROCEDURE.....	27
3.4.2 Deterministic maximum considered earthquake	29
3.5 SITE CLASSIFICATION FOR SEISMIC DESIGN	29
3.5.1 Site class definitions.....	29
3.5.2 Steps for classifying a site.....	30
Chapter 4 STRUCTURAL DESIGN CRITERIA	35
4.1 GENERAL	35
4.1.2 References	35
4.2 GENERAL REQUIREMENTS	35
4.2.1 Design basis	35
4.2.2 Combination of load effects	39
4.3 SEISMIC-FORCE-RESISTING SYSTEM	44
4.3.1 Selection and limitations	44
4.3.2 Configuration	47
4.3.3 Redundancy.....	51

4.4 STRUCTURAL ANALYSIS.....	52
4.4.1 Procedure selection.....	52
4.4.2 Application of loading.....	52
4.5 DEFORMATION REQUIREMENTS.....	52
4.5.1 Deflection and drift limits.....	52
4.5.3 Seismic Design Categories D, E, and F.....	54
4.6 DESIGN AND DETAILING REQUIREMENTS.....	55
4.6.1 Seismic design Category B.....	55
4.6.2 Seismic design Category C.....	58
4.6.3 Seismic Design Category D, E, and F.....	58
ALTERNATIVE SIMPLIFIED CHAPTER 4.....	59
Chapter 5 STRUCTURAL ANALYSIS PROCEDURES.....	63
5.1 GENERAL.....	63
5.2 EQUIVALENT LATERAL FORCE PROCEDURE.....	65
5.2.1 Seismic base shear.....	66
5.2.2 Period determination.....	68
5.2.3 Vertical distribution of seismic forces.....	71
5.2.4 Horizontal shear distribution.....	71
5.2.5 Overturning.....	74
5.2.6 Drift determination and P-delta effects.....	74
5.3 RESPONSE SPECTRUM PROCEDURE.....	76
5.3.2 Modes.....	77
5.3.3 Modal properties.....	77
5.3.4 Modal base shear.....	77
5.3.5 Modal forces, deflections and drifts.....	78
5.3.6 Modal story shears and moments.....	78
5.3.7 Design values.....	78
5.3.8 Horizontal shear distribution.....	79
5.3.9 Foundation overturning.....	79
5.3.10 P-delta effects.....	79
5.4 LINEAR RESPONSE HISTORY PROCEDURE.....	79
5.5 NONLINEAR RESPONSE HISTORY PROCEDURE.....	80
5.5.4 Design review.....	81
5.6 SOIL-STRUCTURE INTERACTION EFFECTS.....	82
5.6.1 General.....	82
5.6.2 Equivalent lateral force procedure.....	87
5.6.3 Response spectrum procedure.....	96
APPENDIX to Chapter 5, NONLINEAR STATIC PROCEDURE.....	103
Chapter 6, ARCHITECTURAL MECHANICAL AND ELECTRICAL COMPONENT DESIGN REQUIREMENTS.....	109
6.1 GENERAL.....	109
6.1.1 Scope.....	109
6.2 GENERAL DESIGN REQUIREMENTS.....	109
6.2.2 Component importance factor.....	109
6.2.3 Consequential damage.....	110
6.2.4 Flexibility.....	111
6.2.5 Component force transfer.....	111
6.2.6 Seismic forces.....	112
6.2.7 Seismic relative displacements.....	115

6.2.8 Component anchorage.....	116
6.2.9 Construction documents.....	117
6.3 ARCHITECTURAL COMPONENTS.....	118
6.3.1 Forces and displacements.....	118
6.3.2 Exterior nonstructural wall elements and connections.....	119
6.3.3 Out-of-plane bending.....	119
6.3.4 Suspended ceilings.....	120
6.3.5 Access floors.....	120
6.3.6 Partitions.....	121
6.3.7 Glass I curtain walls, glazed storefronts and glazed partitions.....	121
6.4 MECHANICAL AND ELECTRICAL COMPONENTS.....	128
6.4.1 Component period.....	130
6.4.2 Mechanical components.....	130
6.4.3 Electrical components.....	130
6.4.4 Supports and attachments.....	131
6.4.5 Utility and service lines.....	131
6.4.6 HVAC ductwork.....	132
6.4.7 Piping systems.....	132
6.4.8 Boilers and pressure vessels.....	133
6.4.9 Elevators.....	133
Appendix to Chapter 6, ALTERNATIVE PROVISIONS FOR THE DESIGN OF PIPING SYSTEMS.....	137
Chapter 7 FOUNDATION DESIGN REQUIREMENTS.....	139
7.1 GENERAL.....	139
7.1.1 Scope.....	139
7.2 GENERAL DESIGN REQUIREMENTS.....	139
7.2.2 Soil capacities.....	139
7.2.3 Foundation load-deformation characteristics.....	139
7.3 SEISMIC DESIGN CATEGORY B.....	139
7.4 SEISMIC DESIGN CATEGORY C.....	139
7.4.1 Investigation.....	139
7.4.2 Pole-type structures.....	153
7.4.3 Foundation ties.....	153
7.4.4 Special pile requirements.....	154
7.5 SEISMIC DESIGN CATEGORIES D, E, and F.....	155
7.5.1 Investigation.....	155
7.5.3 Foundation ties.....	158
7.5.4 Special pile and grade beam requirements.....	158
Appendix to Chapter 7, GEOTECHNICAL ULTIMATE STRENGTH DESIGN OF FOUNDATIONS AND FOUNDATION LOAD-DEFORMATION MODELING.....	167
Chapter 8 STEEL STRUCTURE DESIGN REQUIREMENTS.....	175
8.1 GENERAL.....	175
8.1.2 References.....	175
8.2 GENERAL DESIGN REQUIREMENTS.....	175
8.2.1 Seismic Design Categories B and C.....	175
8.2.2 Seismic Design categories D, E, and F.....	175
8.4 COLD-FORM STEEL.....	175
8.4.2 Light-frame walls.....	175

8.4.4 Steel deck diaphragms	176
8.5 STEEL CABLES	176
8.6 RECOMMENDED PROVISIONS FOR BUCKLING-RESTRAINED BRACED FRAMES	176
8.6.3 Commentary on buckling-restrained braced frames	176
8.7 SPECIAL STEEL PLATE WALLS	189
8.7.3 Scope.....	189
8.7.4 Webs	190
8.7.5 Connections of webs to boundary elements.....	192
8.7.6 Horizontal and vertical boundary elements (HBE and VBE)	192
Chapter 9 CONCRETE STRUCTURE DESIGN REQUIREMENTS	199
9.1 GENERAL	199
9.1.2 References.....	199
9.2 GENERAL DESIGN REQUIREMENTS	199
9.2.1 Classification of shear walls	199
9.2.2 Modifications to ACI 318	199
9.3 SEISMIC DESIGN CATEGORY B.....	200
9.3.1 Ordinary moment frames	200
9.4 SEISMIC DESIGN CATEGORY C.....	200
9.5 SEISMIC DESIGN CATEGORIES D, E, AND F	201
9.6 ACCEPTANCE CRITERIA FOR SPECIAL PRECAST STRUCTURAL WALLS BASED ON VALIDATION TESTING	200
9.6.1 Notation	200
9.6.2 Definitions	200
9.6.3 Scope and general requirements	204
9.6.4 Design procedure	206
9.6.5 Test modules	207
9.6.6 Testing agency	208
9.6.7 Test method.....	209
9.6.8 Test report.....	211
9.6.9 Test module acceptance criteria.....	211
Appendix to Chapter 9, UNTOPPED PRECAST DIAPHRAGMS	217
Chapter 10, COMPOSITE STEEL AND CONCRETE STRUCTURE DESIGN REQUIREMENTS.....	221
10.1 GENERAL	221
10.4 SEISMIC DESIGN CATEGORIES D, E, AND F	221
Chapter 11 MASONRY STRUCTURE DESIGN REQUIREMENTS.....	223
11.1.2 References	223
11.4 GLASS-UNIT MASONRY AND MASONRY VENEER.....	224
11.5 PRESTRESSED MASONRY	224
11.6 ANCHORING TO MASONRY	224
Chapter 12 WOOD STRUCTURE DESIGN REQUIREMENTS	231
12.1 GENERAL.....	231
12.1.2 References.....	231
12.2 DESIGN METHODS.....	231
12.2.1 Seismic design categories B, C, and D	232

12.2.2 Seismic design Categories E and F	233
12.3 GENERAL DESIGN REQUIREMENTS FOR ENGINEERED WOOD CONSTRUCTION	238
12.3.1 Framing	255
12.4 CONVENTIONAL LIGHT-FRAME CONSTRUCTION	255
12.4.1 Limitations	256
12.4.2 Braced walls	257
12.4.3 Detailing requirements	258
 Chapter 13 SEISMICALLY ISOLATED STRUCTURE DESIGN REQUIREMENTS	273
13.1 GENERAL	273
13.1.1 Scope	274
13.2 GENERAL DESIGN REQUIREMENTS	275
13.2.1 Occupancy importance factor	275
13.2.4 Procedure selection	275
13.2.5 Isolation system	277
13.2.6 Structural system	278
13.3 EQUIVALENT LATERAL FORCE PROCEDURE	278
13.3.2 Minimum lateral displacements	278
13.3.3 Minimum distribution of forces	280
13.3.4 Vertical distribution of forces	280
13.3.5 Drift limits	281
13.4 DYNAMIC PROCEDURES	281
13.5 DESIGN REVIEW	282
13.6 TESTING	282
13.6.4 Design properties of the isolation system	283
 Chapter 14 NONBUILDING STRUCTURE DESIGN REQUIREMENTS	287
14.1 GENERAL	287
14.1.1 Scope	287
14.1.2 References	289
14.1.5 Nonbuilding structures supported by other structures	289
14.2 GENERAL DESIGN REQUIREMENTS	290
14.2.1 Seismic Use groups and importance factors	290
14.2.3 Design basis	293
14.2.4 Seismic-force-resisting system selection and limitations	293
14.2.5 Structural analysis procedure selection	294
14.2.9 Fundamental period	294
14.3 NONBUILDING STRUCTURES SIMILAR TO BUILDINGS	294
14.3.1 Electrical power generating facilities	294
14.3.3 Piers and wharves	294
14.3.4 Pipe racks	296
14.3.5 Steel storage tanks	296
14.4 NONBUILDING STRUCTURES NOT SIMILAR TO BUILDINGS	296
14.4.2 Earth retaining structures	296
14.4.3 Stacks and chimneys	296
14.4.7 Tanks and vessels	297
 Appendix to Chapter 14 OTHER NONBUILDING STRUCTURES	305
 Chapter 15 STRUCTURES WITH DAMPING SYSTEMS	309

Commentary Appendix A, DEVELOPMENT OF MAXIMUM CONSIDERED EARTHQUAKE GROUND MOTION MAPS FIGURES 3.3-1 THROUGH 3.3-14.....	317
Commentary Appendix B, DEVELOPMENT OF THE USGS SEISMIC MAPS	331
THE COUNCIL: ITS PURPOSE AND ACTIVITIES	367
BSSC MEMBER ORGANIZATIONS	383
BUILDING SEISMIC SAFETY COUNCIL PUBLICATIONS	384

Chapter 1 Commentary

GENERAL PROVISIONS

Chapter 1 sets forth general requirements for applying the analysis and design provisions contained in Chapters 2 through 14 of the *NEHRP Recommended Provisions for Seismic Regulations for New Buildings and Other Structures*. It is similar to what might be incorporated in a code as administrative regulations.

Chapter 1 is designed to be as compatible as possible with normal code administrative provisions, but it is written as the guide to use of the rest of the document, not as a regulatory mechanism. The word “shall” is used in the *Provisions* not as a legal imperative, but simply as the language necessary to ensure fulfillment of all the steps necessary to technically meet a minimum standard of performance.

It is important to note that the *Provisions* is intended to serve as a resource document for use by any interested member of the building community. Thus, some users may alter certain information within the *Provisions* (e.g., the determination of which use groups are included within the higher Seismic Use Groups might depend on whether the user concluded that the generally more-demanding design requirements were necessary). It is strongly emphasized, however, that such “tailoring” should be carefully considered by highly qualified individuals who are fully aware of all the implications of any changes on all affected procedures in the analysis and design sequences of the document.

Further, although the *Provisions* is national in scope, it presents minimum criteria. It is neither intended to nor does it justify any reduction in higher standards that have been locally established, particularly in areas of highest seismicity.

Reference is made throughout the document to decisions and actions that are delegated to an unspecified “authority having jurisdiction.” The document is intended to be applicable to many different types of jurisdictions and chains of authority, and an attempt has been made to recognize situations where more than technical decision-making can be presumed. In fact, the document anticipates the need to establish standards and approval systems to accommodate the use of the document for development of a regulatory system. A good example of this is in Sec. 1.1.2.5 where the need for well-established criteria and systems of testing and approval are recognized even though few such systems are in place. In some instances, the decision-making mechanism referred to is clearly most logically the province of a building official or department; in others, it may be a law-making body such as a state legislature, a city council, or some other state or local policy-making body. The term “authority having jurisdiction” has been used to apply to all of these entities. A good example of the need for keeping such generality in mind is provided by the California law concerning the design and construction of schools. That law establishes requirements for independent special inspection approved and supervised by the Office of the State Architect, a state-level office that does not exist in many other states.

Note that Appendix A to this *Commentary* volume presents a detailed explanation of the development of *Provisions* Maps 1 through 24 and Appendix B describes development of the U.S. Geological Survey seismic hazard maps on which the *Provisions* maps are based. An overview of the Building Seismic Safety Council (BSSC) and its activities appears at the end of the volume.

1.1 GENERAL

1.1.1 Purpose. The goal of the *Provisions* is to present criteria for the design and construction of new structures subject to earthquake ground motions in order to minimize the hazard to life for all structures, to increase the expected performance of structures having a substantial public hazard due to occupancy or use as compared to ordinary structures, and to improve the capability of essential facilities to function

after an earthquake. To this end, the *Provisions* provides the minimum criteria considered prudent for the protection of life safety in structures subject to earthquakes. The *Provisions* document has been reviewed extensively and balloted by the architectural, engineering, and construction communities and, therefore, it is a proper source for the development of building codes in areas of seismic exposure.

Some design standards go further than the *Provisions* and attempt to minimize damage as well as protect building occupants. For example, the *California Building Code* has added property protection in relation to the design and construction of hospitals and public schools. The *Provisions* document generally considers property damage as it relates to occupant safety for ordinary structures. For high occupancy and essential facilities, damage limitation criteria are more strict in order to better provide for the safety of occupants and the continued functioning of the facility.

Some structural and nonstructural damage can be expected as a result of the “design ground motions” because the *Provisions* allow inelastic energy dissipation in the structural system. For ground motions in excess of the design levels, the intent of the *Provisions* is for the structure to have a low likelihood of collapse.

It must be emphasized that absolute safety and no damage even in an earthquake event with a reasonable probability of occurrence cannot be achieved for most structures. However, a high degree of life safety, albeit with some structural and nonstructural damage, can be achieved economically in structures by allowing inelastic energy dissipation in the structure. The objective of the *Provisions* therefore is to set forth the minimum requirements to provide reasonable and prudent life safety. For most structures designed and constructed according to the *Provisions*, it is expected that structural damage from even a major earthquake would likely be repairable, but the damage may not be economically repairable.

Where damage control is desired, the design must provide not only sufficient strength to resist the specified seismic loads but also the proper stiffness to limit the lateral deflection. Damage to nonstructural elements may be minimized by proper limitation of deformations; by careful attention to detail; and by providing proper clearances for exterior cladding, glazing, partitions, and wall panels. The nonstructural elements can be separated or floated free and allowed to move independently of the structure. If these elements are tied rigidly to the structure, they should be protected from deformations that can cause cracking; otherwise, one must expect such damage. It should be recognized, however, that major earthquake ground motions can cause deformations much larger than the specified drift limits in the *Provisions*.

Where prescribed wind loading governs the stress or drift design, the resisting system still must conform to the special requirements for seismic-force-resisting systems. This is required in order to resist, in a ductile manner, potential seismic loadings in excess of the prescribed loads.

A proper, continuous load path is an obvious design requirement for equilibrium, but experience has shown that it often is overlooked and that significant damage and collapse can result. The basis for this design requirement is twofold:

1. To ensure that the design has fully identified the seismic-force-resisting system and its appropriate design level and
2. To ensure that the design basis is fully identified for the purpose of future modifications or changes in the structure.

Detailed requirements for selecting or identifying and designing this load path are given in the appropriate design and materials chapters.

1.1.2.1 Scope. The scope statement establishes in general terms the applicability of the *Provisions* as a base of reference. Certain structures are exempt and need not comply:

1. Detached one- and two-family dwellings in Seismic Design Categories A, B, and C are exempt because they represent low seismic risks.
2. Structures constructed using the conventional light-frame construction requirements in Sec. 12.5 are deemed capable of resisting the seismic forces imposed by the *Provisions*. While specific elements of conventional light-frame construction may be calculated to be overstressed, there is typically a great deal of redundancy and uncounted resistance in such structures. Detached one- and two-story wood-frame dwellings have generally performed well even in regions of higher seismicity. The requirements of Sec. 12.5 are adequate to provide the safety required for such dwellings without imposing any additional requirements of the *Provisions*.
3. Agricultural storage structures are generally exempt from most code requirements because of the exceptionally low risk to life involved and that is the case of the *Provisions*.
4. Structures in areas with extremely low seismic risk need only comply with the design and detailing requirements for structures assigned to Seismic Design Category A.

The *Provisions* are not retroactive and apply only to existing structures when there is an addition, change of use, or alteration. As a minimum, existing structures should comply with legally adopted regulations for repair and rehabilitation as related to earthquake resistance. (Note: Publications such as the *Handbook for the Seismic Evaluation of Buildings—A Prestandard* [FEMA 310] and the *Prestandard and Commentary for the Seismic Rehabilitation of Buildings* [FEMA 356] are available.)

The *Provisions* are not written to prevent damage due to earth slides (such as those that occurred in Anchorage, Alaska), to liquefaction (such as occurred in Niigata, Japan), or to tsunami (such as occurred in Hilo, Hawaii). It provides for only minimum required resistance to earthquake ground shaking, without settlement, slides, subsidence, or faulting in the immediate vicinity of the structure.

1.1.2.2 Additions. Additions that are structurally independent of an existing structure are considered to be new structures required to comply with the *Provisions*. For additions that are not structurally independent, the intent is that the addition as well as the existing structure be made to comply with the *Provisions* except that an increase of up to 5 percent of the mass contributing to seismic forces is permitted in any elements of the existing structure without bringing the entire structure into compliance with the *Provisions*. Additions also shall not reduce the lateral force resistance of any existing element to less than that required for a new structure.

1.1.2.3 Change of use. When a change in the use of a structure will result in the structure being reclassified to a higher Seismic Use Group, the existing structure must be brought into compliance with the requirements of the *Provisions* as if it were a new structure. Structures in higher Seismic Use Groups are intended to provide a higher level of safety to occupants and in the case of Seismic Use Group III to be capable of performing their safety-related function after a seismic event. An exception is allowed when the change is from Seismic Use Group I to Seismic Use Group II where S_{DS} is less than 0.3. The expense that may be necessary to upgrade such a structure because of a change in the Seismic Use Group cannot be justified for structures located in regions with low seismic risk.

1.1.2.4 Alterations. Alterations include all significant modifications to existing structures that are not classified as an addition. No reduction in strength of the seismic-force-resisting system or stiffness of the structure shall result from an alteration unless the altered structure is determined to be in compliance with the *Provisions*.

Like additions, an increase of not greater than 5 percent of the mass contributing to seismic forces is permitted in any structural element of the existing structure without bringing the entire structure into compliance with the *Provisions*.

The cumulative effects of alterations and additions should not increase the seismic forces in any structural element of the existing structure by more than 5 percent unless the capacity of the element subject to the increased seismic forces is still in compliance with the *Provisions*.

1.1.2.5 Alternate materials and alternate means and methods of construction. It is not possible for a design standard to provide criteria for the use of all possible materials and their combinations and methods of construction either existing or anticipated. While not citing specific materials or methods of construction currently available that require approval, this section serves to emphasize the fact that the evaluation and approval of alternate materials and methods require a recognized and accepted approval system. The requirements for materials and methods of construction contained within the document represent the judgment of the best use of the materials and methods based on well-established expertise and historical seismic performance. It is important that any replacement or substitute be evaluated with an understanding of all the ramifications of performance, strength, and durability implied by the *Provisions*.

It also is recognized that until needed approval standards and agencies are created, authorities having jurisdiction will have to operate on the basis of the best evidence available to substantiate any application for alternates. If accepted standards are lacking, it is strongly recommended that applications be supported by extensive reliable data obtained from tests simulating, as closely as is practically feasible, the actual load and/or deformation conditions to which the material is expected to be subjected during the service life of the structure. These conditions, where applicable, should include several cycles of full reversals of loads and deformations in the inelastic range.

1.2 SEISMIC USE GROUPS

The expected performance of structures shall be controlled by assignment of each structure to one of three Seismic Use Groups. Seismic Use Groups are categorized based on the occupancy of the structures within the group and the relative consequences of earthquake-induced damage to the structures. The *Provisions* specify progressively more conservative strength, drift control, system selection, and detailing requirements for structures contained in the three groups, in order to attain minimum levels of earthquake performance suitable to the individual occupancies.

In previous editions of the *Provisions*, this categorization of structures, by occupancy, or use, was termed a Seismic Hazard Exposure Group. The name Seismic Use Group was adopted in the 1997 *Provisions* as being more representative of the definition of this classification. Seismic hazard relates to the severity and frequency of ground motion expected to affect a structure. Since structures contained in these groups are spread across the various zones of seismicity, from high to low hazard, the groups do not really relate to hazard. Rather the groups, categorized by occupancy or use, are used to establish design criteria intended to produce specific types of performance in design earthquake events, based on the importance of reducing structural damage and improving life safety.

In terms of post-earthquake recovery and redevelopment, certain types of occupancies are vital to public needs. These special occupancies were identified and given specific recognition. In terms of disaster preparedness, regional communication centers identified as critical emergency services should be in a higher classification than retail stores, office buildings, and factories.

Specific consideration is given to Group III, essential facilities required for post-earthquake recovery. Also included are structures that contain substances, that if released into the environment, are deemed to be hazardous to the public. The 1991 Edition included a flag to urge consideration of the need for utility services after an earthquake. It is at the discretion of the authority having jurisdiction which structures are required for post-earthquake response and recovery. This is emphasized with the term “designated” before many of the structures listed in Sec. 1.2.1. Using Item 3, “designated medical facilities having emergency treatment facilities,” as an example, the authority having jurisdiction should inventory medical facilities having emergency treatment facilities within the jurisdiction and designate those to be

required for post-earthquake response and recovery. In a rural location where there may not be a major hospital, the authority having jurisdiction may choose to require outpatient surgery clinics to be designated Group III structures. On the other hand, these same clinics in a major jurisdiction with hospitals nearby may not need to be designated Group III structures.

Group II structures are those having a large number of occupants and those where the occupants' ability to exit is restrained. The potential density of public assembly uses in terms of number of people warrant an extra level of care. The level of protection warranted for schools, day care centers, and medical facilities is greater than the level of protection warranted for occupancies where individuals are relatively self-sufficient in responding to an emergency.

Group I contains all uses other than those excepted generally from the requirements in Sec. 1.1.2.1. Those in Group I have lesser life hazard only insofar as there is the probability of fewer occupants in the structures and the structures are lower and/or smaller.

In structures with multiple uses, the 1988 Edition of the *Provisions* required that the structure be assigned the classification of the highest group occupying 15 percent or more of the total area of the structure. This was changed in the 1991 Edition to require the structure to be assigned to the highest group present. These requirements were further modified to allow different portions of a structure to be assigned different Seismic Use Groups provided the higher group is not negatively impacted by the lower group. When a lower group impacts a higher group, the higher group must either be seismically independent of the other, or the two must be in one structure designed seismically to the standards of the higher group. Care must be taken, however, for the case in which the two uses are seismically independent but are functionally dependent. The fire and life-safety requirements relating to exiting, occupancy, fire-resistive construction and the like of the higher group must not be reduced by interconnection to the lower group. Conversely, one must also be aware that there are instances, although uncommon, where certain fire and life-safety requirements for a lower group may be more restrictive than those for the higher group. Such assignments also must be considered when changes are made in the use of a structure even though existing structures are not generally within the scope of the *Provisions*.

Consideration has been given to reducing the number of groupings by combining Groups I and II and leaving Group III the same as is stated above; however, the consensus of those involved in the *Provisions* development and update efforts to date is that such a merging would not be responsive to the relative performance desired of structures in these individual groups.

Although the *Provisions* explicitly require design for only a single level of ground motion, it is expected that structures designed and constructed in accordance with these requirements will generally be able to meet a number of performance criteria, when subjected to earthquake ground motions of differing severity. The performance criteria discussed here were jointly developed during the BSSC Guidelines and Commentary for Seismic Rehabilitation of Buildings Project (ATC, 1995) and the Structural Engineers Association of California Vision 2000 Project (SEAOC, 1995). In the system established by these projects, earthquake performance of structures is defined in terms of several standardized performance levels and reference ground motion levels. Each performance level is defined by a limiting state in which specified levels of degradation and damage have occurred to the structural and nonstructural building components. The ground motion levels are defined in terms of their probability of exceedance.

Although other terminology has been used in some documents, four performance levels are commonly described as meaningful for the design of structures. These may respectively be termed the operational, immediate occupancy, life safety, and collapse prevention levels. Of these, the operational level represents the least level of damage to the structure. Structures meeting this level when responding to an earthquake are expected to experience only negligible damage to their structural systems and minor damage to nonstructural systems. The structure will retain nearly all of its pre-earthquake strength and

stiffness and all mechanical, electrical, plumbing, and other systems necessary for the normal operation of the structure are expected to be functional. If repairs are required, these can be conducted at the convenience of the occupants.

The risk to life safety during an earthquake in a structure meeting this performance level is negligible. Note, that in order for a structure to meet this level, all utilities required for normal operation must be available, either through standard public service or emergency sources maintained for that purpose. Except for very low levels of ground motion, it is generally not practical to design structures to meet this performance level.

The immediate occupancy level is similar to the operational level although somewhat more damage to nonstructural systems is anticipated. Damage to the structural systems is very slight and the structure retains all of its pre-earthquake strength and nearly all of its stiffness. Nonstructural elements, including ceilings, cladding, and mechanical and electrical components, remain secured and do not represent hazards. Exterior nonstructural wall elements and roof elements continue to provide a weather barrier, and to be otherwise serviceable. The structure remains safe to occupy; however, some repair and clean-up is probably required before the structure can be restored to normal service. In particular, it is expected that utilities necessary for normal function of all systems will not be available, although those necessary for life safety systems would be provided. Some equipment and systems used in normal function of the structure may experience internal damage due to shaking of the structure, but most would be expected to operate if the necessary utility service was available. Similar to the operational level, the risk to life safety during an earthquake in a structure meeting this performance level is negligible. Structural repair may be completed at the occupants' convenience, however, significant nonstructural repair and cleanup is probably required before normal function of the structure can be restored.

At the life safety level, significant structural and nonstructural damage has occurred. The structure may have lost a substantial amount of its original lateral stiffness and strength but still retains a significant margin against collapse. The structure may have permanent lateral offset and some elements of the seismic-force-resisting system may exhibit substantial cracking, spalling, yielding, and buckling. Nonstructural elements of the structure, while secured and not presenting falling hazards, are severely damaged and cannot function. The structure is not safe for continued occupancy until repairs are instituted as strong ground motion from aftershocks could result in life threatening damage. Repair of the structure is expected to be feasible, however, it may not be economically attractive to do so. The risk to life during an earthquake, in a structure meeting this performance level is very low.

At the collapse prevention level a structure has sustained nearly complete damage. The seismic-force-resisting system has lost most of its original stiffness and strength and little margin remains against collapse. Substantial degradation of the structural elements has occurred including extensive cracking and spalling of masonry and concrete elements and buckling and fracture of steel elements. The structure may have significant permanent lateral offset. Nonstructural elements of the structure have experienced substantial damage and may have become dislodged creating falling hazards. The structure is unsafe for occupancy as even relatively moderate ground motion from aftershocks could induce collapse. Repair of the structure and restoration to service is probably not practically achievable.

The design ground motion contained in the *Provisions* is taken as two-thirds of the maximum considered earthquake ground motion. Such ground motion may have a return period varying from a few hundred years to a few thousand years, depending on the regional seismicity. It is expected that structures designed in accordance with the requirements for Group I would achieve the life safety or better performance level for these ground motions. Structures designed in accordance with the requirements for Group III should be able to achieve the Immediate Occupancy or better performance level for this ground motion. Structures designed to the requirements for Group II would be expected to achieve performance better than the life safety level but perhaps less than the immediate occupancy level for this ground motion.

While the design ground motion represents a rare earthquake event, it may not be the most severe event that could ever affect a site. In zones of moderate seismicity, it has been common practice in the past to consider ground motion with a 98 percent chance of non-exceedance in 50 years, or an average return period of 2,500 years, as being reasonably representative of the most severe ground motion ever likely to affect a site. This earthquake has been variously termed a maximum credible earthquake, maximum capable event and, most recently, a maximum considered earthquake. The recent terminology is adopted here in recognition that ground motion of this probability level is not the most severe motion that could ever effect the site, but is considered sufficiently improbable that more severe ground motions need not practically be considered. In regions near major active faults, such as coastal California, estimates of ground motion at this probability of exceedance can produce structural demands much larger than has typically been recorded in past earthquakes. Consequently, in these zones, the maximum considered earthquake is now commonly taken based on conservative estimates of the ground motion from a deterministic event, representing the largest magnitude event that the nearby faults are believed capable of producing.

It is expected that structures designed to the requirements for Group I would be capable of responding to the maximum considered earthquake at a near collapse or better performance level. Structures designed to the requirements for Group III should be capable of responding to such ground motions at the life safety level. Structures designed and constructed to the requirements for Group II structures should be capable of responding to maximum considered earthquake ground motions with a performance intermediate to the near collapse and life safety levels.

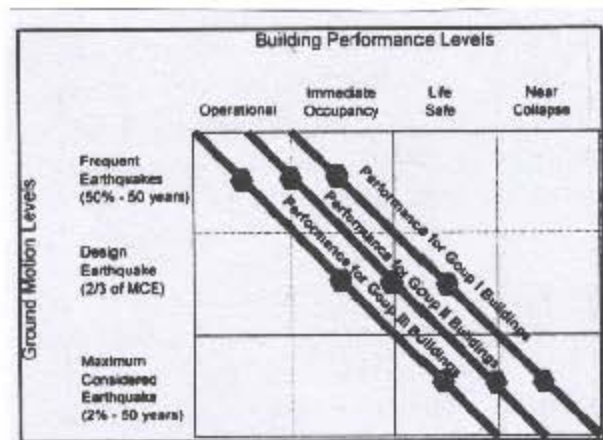

Figure 1.2-1 Expected building performance.

In zones of high seismicity, structures may experience strong motion earthquakes several times during their lives. It is also important to consider the performance expected of structures for these somewhat less severe, but much more frequent, events. For this purpose, earthquake ground shaking with a 50 percent probability of non-exceedance in 50 years may be considered. Sometimes termed a maximum probable event (MPE), such ground motion would be expected to recur at a site, one time, every 72 years. Structures designed to the requirements for Group I would be expected to respond to such ground motion at the Immediate Occupancy level. Structures designed and constructed to either the Group II or Group III requirements would be expected to perform to the Operational level for these events. This performance is summarized in Figure C1.2-1.

It is important to note that while the performance indicated in Figure C1.2-1 is generally indicative of that expected for structures designed in accordance with the *Provisions*, there can be significant variation in the performance of individual structures from these expectations. This variation results

from individual site conditions, quality of construction, structural systems, detailing, overall configuration of the structure, inaccuracies in our analytical techniques, and a number of other complex factors. As a result of these many factors, and intentional conservatism contained in the *Provisions*, most structures will perform better than indicated in the figure and others will not perform as well.

1.2.5 Seismic Use Group III structure access protection. This section establishes the requirement for access protection for Seismic Use Group III structures. There is a need for ingress/egress to those structures that are essential post-earthquake facilities and this shall be considered in the siting and design of the structure.

1.3 OCCUPANCY IMPORTANCE FACTOR

Although the concept of an occupancy importance factor for structural systems has been included in the *Uniform Building Code* for many years, it was first adopted into the 1997 Edition of the *Provisions*. The inclusion of the occupancy importance factor is one of several requirements included in this edition of the *Provisions* where there are attempts to control the seismic performance capability of structures in the different Seismic Use Groups. Specifically, the occupancy importance factor modifies the R coefficients used to determine minimum design base shears. Structures assigned occupancy importance factors greater than 1.0 must be designed for larger seismic forces. As a result, these structures are expected to experience lower ductility demands than structures designed with lower occupancy importance factors and, thus sustain less damage. The *Provisions* also include requirements that attempt to limit vulnerability to structural damage by specifying more stringent drift limits for structures in Seismic Use Groups of higher risk. Further discussion of these concepts is found in *Commentary* Sec. 4.2.1 and 4.5.

1.4 SEISMIC DESIGN CATEGORY

This section establishes the design categories that are the keys for establishing design requirements for any structure based on its use (Seismic Use Group) and on the level of expected seismic ground motion. Once the Seismic Design Category (A, B, C, D, E, or F) for the structure is established, many other requirements such as detailing, quality assurance, system limits, height limitations, specialized requirements, and change of use are related to it.

Prior to the 1997 edition of the *Provisions*, these categories were termed Seismic Performance Categories. While the desired performance of the structure, under the design earthquake, was one consideration used to determine which category a structure should be assigned to, it was not the only factor. The seismic hazard at the site was actually the principle parameter that affected a structure's category. The name was changed to Seismic Design Category to represent the uses of these categories, which is to determine the specific design requirements.

The earlier editions of the *Provisions* utilized the peak velocity-related acceleration, A_v , to determine a building's Seismic Performance Category. However, this coefficient does not adequately represent the damage potential of earthquakes on sites with soil conditions other than rock. Consequently, the 1997 *Provisions* adopted the use of response spectral acceleration parameters S_{DS} and S_{DI} , which include site soil effects for this purpose. Instead of a single table, as was present in previous editions of the *Provisions*, two tables are now provided, relating respectively to short-period and long-period ground motions.

Seismic Design Category A represents structures in regions where anticipated ground motions are minor, even for very long return periods. For such structures, the *Provisions* require only that a complete seismic-force-resisting system be provided and that all elements of the structure be tied together. A nominal design force equal to 1 percent of the weight of the structure is used to proportion the lateral system.

It is not considered necessary to specify seismic-resistant design on the basis of a maximum considered earthquake ground motion for Seismic Design Category A structures because the ground motion

computed for the areas where these structures are located is determined more by the rarity of the event with respect to the chosen level of probability than by the level of motion that would occur if a small but close earthquake actually did occur. However, it is desirable to provide some protection against earthquakes and many other types of unanticipated loadings. Thus, the requirements for Seismic Design Category A provide a nominal amount of structural integrity that will improve the performance of buildings in the event of a possible but rare earthquake even though it is possible that the ground motions could be large enough to cause serious damage or even collapse. The result of design to Seismic Design Category A requirements is that fewer buildings would collapse in the vicinity of such an earthquake.

The integrity is provided by a combination of requirements. First, a complete load path for lateral forces must be identified. Then it must be designed for a lateral force based on a 1 percent acceleration of the mass. The minimum connection forces specified for Seismic Design Category A also must be satisfied.

The 1 percent value has been used in other countries as a minimum value for structural integrity. For many structures, design for the wind loadings specified in the local buildings codes normally will control the lateral force design when compared to the minimum integrity force on the structure. However, many low-rise, heavy structures or structures with significant dead loads resulting from heavy equipment may be controlled by the nominal 1 percent acceleration. Also, minimum connection forces may exceed structural forces due to wind in some structures.

Seismic Design Category B includes Seismic Use Group I and II structures in regions of seismicity where only moderately destructive ground shaking is anticipated. In addition to the requirements for Seismic Design Category A, structures in Seismic Design Category B must be designed for forces determined using Maps 1 through 24.

Seismic Design Category C includes Seismic Use Group III structures in regions where moderately destructive ground shaking may occur as well as Seismic Use Group I and II structures in regions with somewhat more severe ground shaking potential. In Seismic Design Category C, the use of some structural systems is limited and some nonstructural components must be specifically designed for seismic resistance.

Seismic Design Category D includes structures of Seismic Use Group I, II, and III located in regions expected to experience destructive ground shaking but not located very near major active faults. In Seismic Design Category D, severe limits are placed on the use of some structural systems and irregular structures must be subjected to dynamic analysis techniques as part of the design process.

Seismic Design Category E includes Seismic Use Group I and II structures in regions located very close to major active faults and Seismic Design Category F includes Seismic Use Group III structures in these locations. Very severe limitations on systems, irregularities, and design methods are specified for Seismic Design Categories E and F. For the purpose of determining if a structure is located in a region that is very close to a major active fault, the *Provisions* use a trigger of a mapped maximum considered earthquake spectral response acceleration parameter at 1-second period, S_1 , of 0.75 or more regardless of the structure's fundamental period. The mapped short period acceleration, S_5 , was not used for this purpose because short period response accelerations do not tend to be affected by near-source conditions as strongly as do response accelerations at longer periods.

Local or regional jurisdictions enforcing building regulations need to consider the effect of the maps, typical soil conditions, and Seismic Design Categories on the practices in their jurisdictional areas. For reasons of uniformity of practice or reduction of potential errors, adopting ordinances could stipulate particular values of ground motion, particular Site Classes, or particular Seismic Design Categories for all or part of the area of their jurisdiction. For example:

1. An area with an historical practice of high seismic zone detailing might mandate a minimum Seismic Design Category of D regardless of ground motion or Site Class.
2. A jurisdiction with low variation in ground motion across the area might stipulate particular values of the ground motion rather than requiring use of the maps.
3. An area with unusual soils might require use of a particular Site Class unless a geotechnical investigation proves a better Site Class.

There are two limits on period for permission to ignore S_{DI} when establishing the Seismic Design Category. The first rule, requiring T_a be less than 80% of T_s , allows some conservatism for the uncertainty in estimating periods. The second rule only applies where a different period is used for computing drift than for computing forces. In that case, the period used for establishing drift must be less than the corner period, T_s . It should be noted that the period used for establishing drift could simply be T_a and, as such, does not require that the actual building period be calculated.

1.4.2 Site limitation for Seismic Design Categories E and F. The forces that result on a structure located astride the trace of a fault rupture that propagates to the surface are extremely large and it is not possible to reliably design a structure to resist such forces. Consequently, the requirements of this section limit the construction of buildings in Seismic Design Categories E and F on sites subject to this hazard. Similarly, the effects of landsliding, liquefaction, and lateral spreading can be highly damaging to a building. However, the effects of these site phenomena can more readily be mitigated through the incorporation of appropriate design measures than can direct ground fault rupture. Consequently, construction on sites with these hazards is permitted if appropriate mitigation measures are included in the design.

1.5 REQUIREMENTS FOR SEISMIC DESIGN CATEGORY A

Because of the very low seismicity associated with sites with S_{DS} less than 0.25 and S_{DI} less than 0.10, it is considered appropriate for Category A buildings to require only a complete seismic-force-resisting system, good quality of construction materials and adequate ties and anchorage as specified in this section. Category A buildings will be constructed in a large portion of the United States that is generally subject to strong winds but low earthquake risk. Those promulgating construction regulations for these areas may wish to consider many of the low-level seismic requirements as being suitable to reduce the windstorm risk. Since the *Provisions* considers only earthquakes, no other requirements are prescribed for Category A buildings. Only a complete seismic-force-resisting system, ties, and wall anchorage are required by these *Provisions*.

Construction qualifying under Category A may be built with no special detailing requirements for earthquake resistance. Special details for ductility and toughness are not required in Category A.

1.5.1 Lateral forces. This analysis procedure, which was added to the *Provisions* in the 1997 edition, is applicable only to structures in Seismic Design Category A. Such structures are not designed for resistance to any specific level of earthquake ground shaking as the probability that they would ever experience shaking of sufficient intensity to cause life threatening damage is very low so long as the structures are designed with basic levels of structural integrity. Minimum levels of structural integrity are achieved in a structure by assuring that all elements in the structure are tied together so that the structure can respond to shaking demands in an integral manner and also by providing the structure with a complete seismic-force-resisting system. It is believed that structures having this level of integrity would be able to resist, without collapse, the very infrequent earthquake ground shaking that could affect them. In addition, requirements to provide such integrity provides collateral benefit with regard to the ability of the structure to survive other hazards such as high wind storms, tornadoes, and hurricanes.

The procedure outlined in this section is intended to be a simple approach to ensuring both that a building has a complete seismic-force-resisting system and that it is capable of sustaining at least a

minimum level of lateral force. In this analysis procedure, a series of static lateral forces equal to 1 percent of the weight at each level of the structure is applied to the structure independently in each of two orthogonal directions. The structural elements of the seismic-force-resisting system then are designed to resist the resulting forces in combination with other loads under the load combinations specified by the building code.

The selection of 1 percent of the building weight as the design force for Seismic Design Category A structures is somewhat arbitrary. This level of design lateral force was chosen as being consistent with prudent requirements for lateral bracing of structures to prevent inadvertent buckling under gravity loads and also was believed to be sufficiently small as to not present an undue burden on the design of structures in zones of very low seismic activity.

The seismic weight W is the total weight of the building and that part of the service load that might reasonably be expected to be attached to the building at the time of an earthquake. It includes permanent and movable partitions and permanent equipment such as mechanical and electrical equipment, piping, and ceilings. The normal human live load is taken to be negligibly small in its contribution to the seismic lateral forces. Buildings designed for storage or warehouse usage should have at least 25 percent of the design floor live load included in the weight, W . Snow loads up to 30 psf (1400 Pa) are not considered. Freshly fallen snow would have little effect on the lateral force in an earthquake; however, ice loading would be more or less firmly attached to the roof of the building and would contribute significantly to the inertia force. For this reason, the effective snow load is taken as the full snow load for those regions where the snow load exceeds 30 psf with the proviso that the local authority having jurisdiction may allow the snow load to be reduced up to 80 percent. The question of how much snow load should be included in W is really a question of how much ice buildup or snow entrapment can be expected for the roof configuration or site topography, and this is a question best left to the discretion of the local authority having jurisdiction.

1.5.2 Connections. The requirements in this section are a simplified version of the material found in Sec. 4.6.1.1. For Seismic Design Category A, 5 percent is always greater than 0.133 times S_{DS} .

1.5.3 Anchorage of concrete or masonry walls. The intent of this section is to ensure that out-of-plane inertia forces generated within a concrete or masonry wall can be transferred to the adjacent roof or floor construction. The transfer can be accomplished only by reinforcement or anchors.

This page is intentionally left blank.

Chapter 2 Commentary

QUALITY ASSURANCE

2.1 GENERAL

2.1.1 Scope. Quality assurance (control and verification) for structures assigned to Seismic Design Categories C, D, E and F, is necessary due to the complexity of the seismic-force-resisting systems and is important because of the serious consequences of the failure of structures. The level of quality assurance varies with the degree of seismic risk.

Quality Assurance requirements involve many aspects of the structural design and construction process—from the selection of the design team and their suitability for the project to the capabilities of the construction contractor(s) and subcontractors, whether selected by qualification or by low bid. Where structures are to be located in areas with a high probability of having damaging earthquake ground motion, adequate quality assurance is required to provide life safety. Unfortunately, in recent seismic events there have been numerous earthquake-related failures that are directly traceable to poor design or poor quality control during construction; these deficiencies must be eliminated. The earthquake requirements included in the *Provisions* rely heavily upon the concept of adequate quality control and verification to assure sound construction. It is important that all parties involved in the design and construction process understand and support the quality assurance requirements recommended in the *Provisions*.

The technological complexity of the design of modern structures necessitates employment of a team of registered design professionals. Each member in responsible charge of design of each element or system of the structure must be qualified and licensed by the jurisdiction to practice in their technical fields of practice. Structures located at a site with a potential to have damaging earthquake ground motion must be designed to withstand the resulting seismic forces and accommodate element displacements.

Every element of a structure is a part of a continuous load path transmitting seismic forces from and to the foundations, which must be adequately strengthened and appropriately anchored to resist the seismic forces and to accommodate the resulting displacements. Many of the failures in recent earthquakes have been attributed to weak links in the seismic-force-resisting load paths. Since the connections between adjacent elements of the structure often involve different registered design professionals and different construction trades during installation, it is imperative that these connections be adequately described in the construction documents and observed during installation. In order to accommodate these constraints and produce a coordinated design, the registered design professionals must function as an integrated and well coordinated team.

The selection of the size and configuration of the structure, and the type of structural seismic-force-resisting system(s) selected, can have a significant impact on the performance of the structure in an earthquake. Since the selection can affect the design and cost of construction of almost every element of the structure, it is essential that the entire design team participate in making these preliminary design decisions and appropriately accommodate them in their design. While not required by the *Provisions*, it is recommended that a quality assurance plan be prepared for the design process.

For quality assurance during construction, the following is included in the *Provisions*: (1) the registered design professional(s) in responsible charge of the design specifies the quality assurance requirements; (2) the prime contractor(s) exercises the control necessary to achieve the required quality; and (3) the owner monitors the construction process by means of consultants who perform special inspections, observations, and testing. It is important that all of the parties involved recognize their responsibilities, understand the procedures, and are capable of carrying them out. Because the contractor and specialty subcontractors are performing the work and exercising control of quality, it is essential that the special inspections and tests be performed by someone not in their direct employ. For this reason, the special

inspectors are the owner's inspectors and serve at the discretion of the authority having jurisdiction. When the owner is also the contractor, the owner, to avoid a potential conflict of interest, must engage independent agencies to conduct the special inspections and tests rather than try to qualify his own employees for that purpose.

The contractual responsibilities during the construction phase vary from project to project depending on the structure, and the desires of the owner. The majority of building owners use the standard contract forms published by the American Institute of Architects (AIA) or the Engineers' Joint Contract Documents Committee (EJCDC) (or a contract modeled therefrom) which include specific construction phase responsibilities.

The registered design professional in responsible charge for each portion of the project is the most knowledgeable person available for assuring appropriate conformance with the intent of the design as conveyed in the construction documents. It is essential that a registered design professional be sufficiently involved during the construction phase of the project to assure general conformance with the approved construction documents. Courts are ruling more frequently that the above responsibilities remain that of the registered design professional in responsible charge of the design regardless of the language included in the contract for professional services.

The quality assurance requirements included in Chapter 2 of the *Provisions* are the minimum requirements. It could be the decision of the owner or registered design professional to include more stringent quality assurance requirements. The primary method for achieving quality assurance is through the use of special inspectors and testing agencies.

Registered design professional(s) in responsible charge, or their employees, may perform the special inspections, when approved by the authority having jurisdiction. Increased involvement by the registered design professional in responsible charge allows for early detection of problems during construction when they can be resolved more easily.

2.2 GENERAL REQUIREMENTS

Because of the complexity of design and construction for structures included in Seismic Design Categories C, D, E, and F, it is necessary to provide a comprehensive written quality assurance plan to assure adequate quality controls and verification during construction. Each portion of the quality assurance plan is required to be prepared by the registered design professional responsible for the design of the seismic-force-resisting system(s) and other designated seismic systems that are subject to requirements for quality assurance. When completed, the quality assurance plan must be submitted to the owner and to the authority having jurisdiction.

The performance for quality control of the contractors and subcontractors varies from project to project. The quality assurance plan provides an opportunity for the registered design professional to delineate the types and frequency of testing and inspections, and the extent of the structural observations to be performed during the construction process and to assure that the construction is in conformance with the approved construction documents. Special attention should be given in the quality assurance plan for projects with higher occupancy importance factors.

The authority having jurisdiction shall approve the quality assurance plan and shall obtain from each contractor a written statement that the contractor understands the requirements of the quality assurance plan and will exercise the necessary control to obtain conformance. The exact methods of control are the responsibility of the individual contractors, subject to approval by the authority having jurisdiction. Special inspections, in addition to those included in the quality assurance plan, may be required by the authority having jurisdiction to ensure that there is compliance with the approved construction documents.

As indicated in Sec. 2.2, certain regular, low-rise structures assigned to Seismic Use Group I are exempt from preparation of a quality assurance plan. Any structure that does not satisfy all of the criteria included in the exception or is not otherwise exempted by the *Provisions* is required to have a quality

assurance plan. It is important to emphasize that this exemption only applies to the preparation of a quality assurance plan. All special inspections and testing that are otherwise required by the *Provisions* must be performed.

2.3 SPECIAL INSPECTION

Special inspection is the monitoring of materials and workmanship that are critical to the integrity of the structure. The requirements listed in this section, from foundation systems through cold-formed steel framing, have been included in the national model codes for many years. It is a premise of the *Provisions* that there will be an adequate supply of knowledgeable and experienced inspectors available to provide the necessary special inspections for the structural categories of work. Special training programs may have to be developed and implemented for the nonstructural categories.

A special inspector is a person approved by the authority having jurisdiction as being qualified to perform special inspections for the category of work involved. As a guide to the authority having jurisdiction, it is suggested that the special inspector is to be one of the following:

1. A person employed and supervised by the registered design professional in responsible charge for the design of the designated seismic system or the seismic-force-resisting system for which the special inspector is engaged.
2. A person employed by an approved inspection and/or testing agency who is under the direct supervision of a registered design professional also employed by the same agency, using inspectors or technicians qualified by recognized industry organizations as approved by the authority having jurisdiction.
3. A manufacturer or fabricator of components, equipment, or machinery that has been approved for manufacturing components that satisfy seismic safety standards and that maintain a quality assurance plan approved by authority having jurisdiction. The manufacturer or fabricator is required to provide evidence of such approval by means of clear marks on each designated seismic system or seismic-force-resisting system component shipped to the construction site.

The extent and duration of special inspections, types of testing, and the frequency of the testing must be clearly delineated in the quality assurance plan. In some instances the *Provisions* allow periodic special inspection rather than continuous special inspection. Where periodic special inspections are allowed, the *Provisions* do not state specific requirements for frequency of periodic inspection, but do indicate stages of construction at which inspection is required for a particular category of work. The quality assurance plan should generally indicate the timing and extent of any periodic special inspections required by the *Provisions*.

2.3.9 Architectural components. It is anticipated that the minimum requirements for architectural components (such as exterior cladding) are satisfied if the method of anchoring components and the number, spacing, and types of fasteners used conform to approved construction documents.

For ceilings and access floors compliance with the construction documents should concentrate on critical details. For ceiling grids those details are the location and installation for grid bracing, the connection of runners to the perimeter edge member along two adjacent sides, and the gap provided between ends of runners and the edge member on the remaining two sides.

2.3.10 Mechanical and electrical components. It is anticipated that the minimum requirements for mechanical and electrical components are satisfied if the method of anchoring components and the number, spacing, and types of fasteners actually used conform to the approved construction documents. It is noted that such special inspection requirements are for selected electrical, lighting, piping, and ductwork components in any Seismic Design Category except A or B, and for all electrical equipment in Seismic Design Category E or F.

2.4 TESTING

Compliance with nationally recognized test standards provides the authority having jurisdiction and the owner a means to determine the acceptability of materials and their placement. Most test standards for materials are developed and maintained by the American Society for Testing and Materials (ASTM). Through their reference in model building codes and material specifications, ASTM Standards and other standard testing procedures provide a uniform measure for acceptance of materials and construction. The *Provisions* and the model building codes require that standard tests be performed by an approved testing agency.

Special inspector(s) are responsible for the observation and verification of the testing procedures performed in the field. Special inspectors determine compliance with test standards based on their interpretation of the standards, as measured against acceptance criteria that are included in the construction documents and the quality assurance plan.

Test standards also assign responsibility to others. For example, the ASTM A 706 specification for low-alloy steel reinforcing bars requires the manufacturer to report the chemical composition and carbon equivalent of the material. In addition, the ANSI/AWS D1.4 Welding Code requires the contractor to prepare written specifications for the welding of reinforcing bars. It is necessary, therefore, that each member of the construction team has a thorough knowledge of the specified test standards that cover their particular work.

2.4.5 Mechanical and electrical equipment. The registered design professional should consider requirements to demonstrate the seismic performance of mechanical and electrical components critical to the post-earthquake life safety of the occupants. Any requirements should be clearly indicated on the construction documents. Any currently accepted technology should be acceptable to demonstrate compliance with the requirements.

It is intended that the certificate only be requested for components with an importance factor (I_p) greater than 1.00 and only if the component has a doubtful or uncertain seismic load path. This certificate should not be requested to validate functionality concerns.

In the context of the *Provisions*, seismic adequacy of the component is of concern only when the component is required to remain operational after an earthquake or contains material that can pose a significant hazard if released. Meeting the requirements of this section shall be considered as an acceptable demonstration of the seismic adequacy of a component.

2.5 STRUCTURAL OBSERVATIONS

The purpose of structural observations is to allow the registered design professional(s) in responsible charge or other registered design professional(s) to visit the site to observe the seismic-force-resisting systems. Observations include verifying that the seismic-force-resisting system is constructed in general conformance with the construction documents, that the intent of the design has been accomplished, and that a complete lateral load path exists.

Every effort shall be made to have the registered design professional in responsible charge make the observations. If another registered design professional performs the observations he is expected to be familiar with the construction documents and the design concept.

2.6 REPORTING AND COMPLIANCE PROCEDURES

The purpose of this section is to keep key parties informed of the special inspector's observations and the contractor's corrections.

Chapter 3 Commentary

GROUND MOTION

3.1 GENERAL

3.1.3 Definitions. The *Provisions* are intended to provide uniform levels of performance for structures, depending on their occupancy and use and the risk to society inherent in their failure. Sec. 1.2 of the *Provisions* establishes a series of Seismic Use Groups, which are used to assign each structure to a specific Seismic Design Category. It is the intent of the *Provisions* that meeting the seismic design criteria will provide a uniform margin against failure for all structures within a given Seismic Use Group.

In past editions of the *Provisions*, seismic hazards around the nation were defined at a uniform 10 percent probability of exceedance in 50 years and the design requirements were based on assigning a structure to a Seismic Hazard Exposure Group and a Seismic Performance Category. While this approach provided for a uniform likelihood throughout the nation that the design ground motion would not be exceeded, it did not provide for a uniform probability of failure for structures designed for that ground motion. The reason for this is that the rate of change of earthquake ground motion versus likelihood is not constant in different regions of the United States.

The approach adopted in the *Provisions* is intended to provide for a uniform margin against collapse at the design ground motion. In order to accomplish this, ground motion hazards are defined in terms of maximum considered earthquake ground motions. The maximum considered earthquake ground motions are based on a set of rules that depend on the seismicity of an individual region. The design ground motions are based on a lower bound estimate of the margin against collapse inherent in structures designed to the *Provisions*. This lower bound was judged, based on experience, to correspond to a factor of about 1.5 in ground motion. Consequently, the design earthquake ground motion was selected at a ground shaking level that is 1/1.5 (2/3) of the maximum considered earthquake ground motion.

For most regions of the nation, the maximum considered earthquake ground motion is defined with a uniform probability of exceedance of 2 percent in 50 years (return period of about 2500 years). While stronger shaking than this could occur, it was judged that it would be economically impractical to design for such very rare ground motions and that the selection of the 2 percent probability of exceedance in 50 years as the maximum considered earthquake ground motion would result in acceptable levels of seismic safety for the nation.

In regions of high seismicity, such as coastal California, the seismic hazard is typically controlled by large-magnitude events occurring on a limited number of well-defined fault systems. Ground shaking calculated at a 2 percent probability of exceedance in 50 years would be much larger than that which would be expected based on the characteristic magnitudes of earthquakes on these known active faults. This is because these major active faults can produce characteristic earthquakes every few hundred years. For these regions, it is considered more appropriate to directly determine maximum considered earthquake ground motions based on the characteristic earthquakes of these defined faults. In order to provide for an appropriate level of conservatism in the design process, when this approach to calculation of the maximum considered earthquake ground motion is used, the median estimate of ground motion resulting for the characteristic event is multiplied by 1.5.

Sec. 4.1.1 of the *Provisions* defines the maximum considered earthquake ground motion in terms of the mapped values of the spectral response acceleration at short periods, S_s , and at 1 second, S_1 , for Class B sites. These values may be obtained directly from Maps 1 through 24, respectively. A detailed explanation for the development of Maps 1 through 24 appears as Appendix A to this *Commentary* volume. The procedure by which these maps were created, as described above and in Appendix A, is

also included in the *Provisions* under Sec 3.4 so that registered design professionals performing such studies may use methods consistent with those that served as the basis for developing the maps.

3.2 GENERAL REQUIREMENTS

3.2.2 Procedure selection. This section sets alternative procedures for determining ground shaking parameters for use in the design process. The design requirements generally use response spectra to represent ground motions in the design process. For the purposes of the *Provisions*, these spectra are permitted to be determined using either a generalized procedure in which mapped seismic response acceleration parameters are referred to or by site-specific procedures. The generalized procedure in which mapped values are used is described in Sec. 3.3. The site-specific procedure is described in Sec. 3.4.

3.3 GENERAL PROCEDURE

This section provides the procedure for obtaining design site spectral response accelerations using the maps provided with the *Provisions*. Many buildings and structures will be designed using the equivalent lateral force procedure of Sec. 5.2, and this general procedure to determine the design spectral response acceleration parameters, S_{DS} and S_{DI} , that are directly used in that procedure. Some structures will be designed using the response spectrum procedure of Sec. 5.3. This section also provides for the development of a general response spectrum, which may be used directly in the modal analysis procedure, from the design spectral response acceleration parameters, S_{DS} and S_{DI} .

Maps 1 and 2 respectively provide two parameters, S_S and S_I , based on a national seismic hazard study conducted by the U.S. Geological Survey. For most buildings and sites, they provide a suitably accurate estimate of the maximum considered earthquake ground shaking for design purposes. For some sites, with special soil conditions or for some buildings with special design requirements, it may be more appropriate to determine a site-specific estimate of the maximum considered earthquake ground shaking response accelerations. Sec. 3.4 provides guidance on site-specific procedures.

S_S is the mapped value, from Map 1 of the 5-percent-damped maximum considered earthquake spectral response acceleration, for short period structures founded on Class B, firm rock, sites. The short-period acceleration has been determined at a period of 0.2 seconds. This is because it was concluded that 0.2 seconds was reasonably representative of the shortest effective period of buildings and structures that are designed by the *Provisions*, considering the effects of soil compliance, foundation rocking, and other factors typically neglected in structural analysis.

Similarly, S_I is the mapped value from Map 2 of the 5-percent-damped maximum considered earthquake spectral response acceleration at a period of 1 second on Site Class B. The spectral response acceleration at periods other than 1 second can typically be derived from the acceleration at 1 second. Consequently, these two response acceleration parameters, S_S and S_I , are sufficient to define an entire response spectrum for the period range of importance for most buildings and structures, for maximum considered earthquake ground shaking on Class B sites.

In order to obtain acceleration response parameters that are appropriate for sites with other characteristics, it is necessary to modify the S_S and S_I values, as indicated in Sec.3.3.2. This modification is performed with the use of two coefficients, F_a and F_v , which respectively scale the S_S and S_I values determined for firm rock sites to values appropriate for other site conditions. The maximum considered earthquake spectral response accelerations adjusted for Site Class effects are designated S_{MS} and S_{MI} , respectively, for short-period and 1-second-period response. As described above, structural design in the *Provisions* is performed for earthquake demands that are 2/3 of the maximum considered earthquake response spectra. Two additional parameters, S_{DS} and S_{DI} , are used to define the acceleration response spectrum for this design level event. These are taken, respectively, as 2/3 of the maximum considered earthquake values, S_{MS} and S_{MI} , and completely define a design response spectrum for sites of any characteristics.

Sec. 3.5.1 provides a categorization of the various classes of site conditions, as they affect the design response acceleration parameters. Sec. 3.5.2 describes the steps by which sites can be classified as belonging to one of these Site Classes.

3.3.2 Site coefficients and adjusted acceleration parameters. The site coefficients F_a and F_v presented in *Provisions* Tables 3.3-1 and 3.3-2 are based on the research described in the following paragraphs.

It has long been recognized that the effects of local soil conditions on ground motion characteristics should be considered in building design. The 1989 Loma Prieta earthquake provided abundant strong motion data that was used extensively together with other information in introducing the site coefficients F_a and F_v into the 1994 *Provisions*.

The amount of ground motion amplification by a soil deposit relative to bedrock depends on the wave-propagation characteristics of the soil, which can be estimated from measurements or inferences of shear-wave velocity and in turn the shear modulus for the materials as a function of the level of shaking. In general, softer soils with lower shear-wave velocities exhibit higher amplifications than stiffer soils with higher shear velocities. Increased levels of ground shaking result in increased soil stress-strain nonlinearity and increased soil damping which in general reduces the amplification, especially for shorter periods. Furthermore, for soil deposits of sufficient thickness, soil amplification is generally greater at longer periods than at the shorter periods. Based on the studies summarized below, values of the soil amplification factors (site coefficients) shown in Tables 3.3-1 and 3.3-2 were developed as a function of site class and level of ground shaking. Table 3.3-1 presents the short-period site coefficient, F_a ; Table 3.3-2 presents the long-period site coefficient, F_v . As described in Sec. 3.5, Site Classes A through E describe progressively softer (lower shear wave velocity) soils.

Strong-motion recordings obtained on a variety of geologic deposits during the Loma Prieta earthquake of October 17, 1989 provided an important empirical basis for the development of the site coefficients F_a and F_v . Figure C3.3.2-1 presents average response spectra of ground motions recorded on soft clay and rock sites in San Francisco and Oakland during the Loma Prieta earthquake. The peak acceleration (which plots at zero-period of the response spectra) was about 0.08 to 0.1 g at the rock sites and was amplified two to three times to 0.2 g or 0.3 g at the soft soil sites. The response spectral accelerations at short periods (~ 0.2 or 0.3 second) were also amplified on average by factors of 2 or 3. It can be seen in Figure C3.3.2-1 that, at longer periods between about 0.5 and 1.5 or 2 seconds, the amplifications of response spectra on the soft clay site relative to rock were even greater, ranging from about 3 to 6 times. Ground motions on stiff soil sites were also observed to be amplified relative to rock sites during the Loma Prieta earthquake, but by smaller factors than on soft soils.

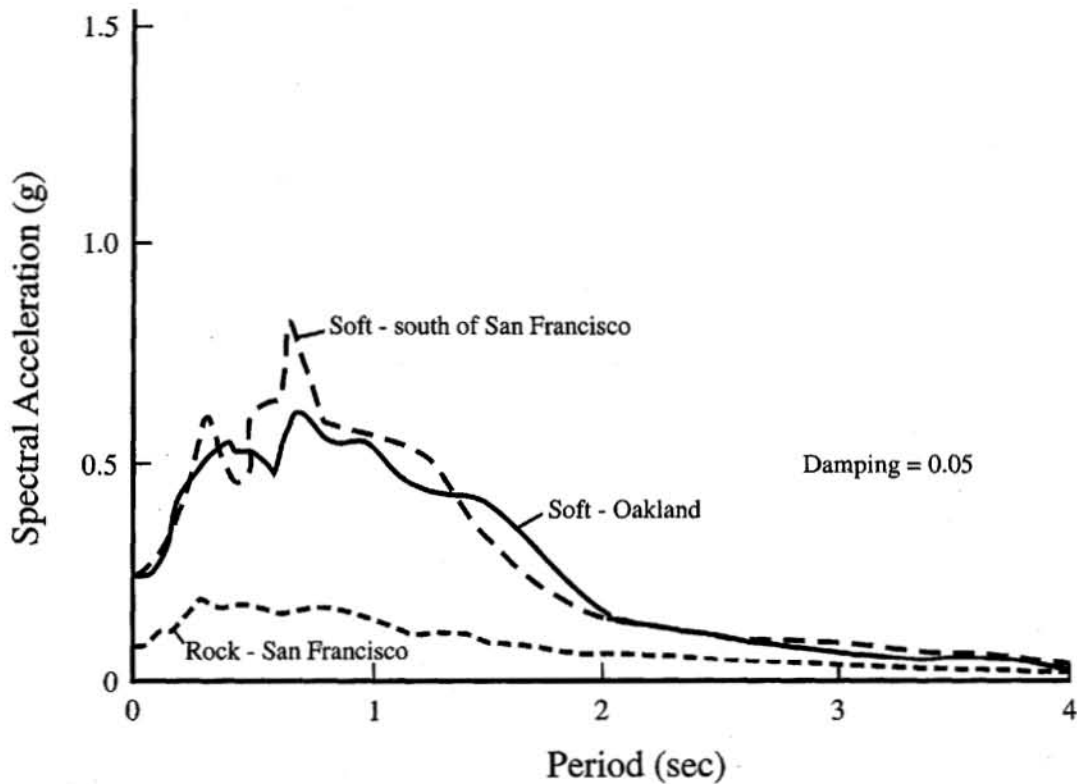

Figure C3.3.2-1. Average spectra recorded during the 1989 Loma Prieta earthquake in San Francisco Bay area at rock sites and soft soil sites (modified after Housner, 1990).

Average amplification factors derived from the Loma Prieta earthquake data with respect to “firm to hard rock” for short-period (0.1-0.5 sec), intermediate-period (0.5-1.4 sec), mid-period (0.4-2.0 sec), and long-period (1.5-5.0 sec) bands, show that a short-period factor and a mid-period factor (the mid-period factor was later renamed the long-period factor in the NEHRP Provisions) are sufficient to characterize the response of the local site conditions (Borcherdt, 1994). This important result is consistent with the two-factor approach to response spectrum construction summarized in Figure C3.3.2-2. Empirical regression curves fitted to these amplification data as a function of mean shear wave velocity at a site are shown in Figure C3.3.2-3.

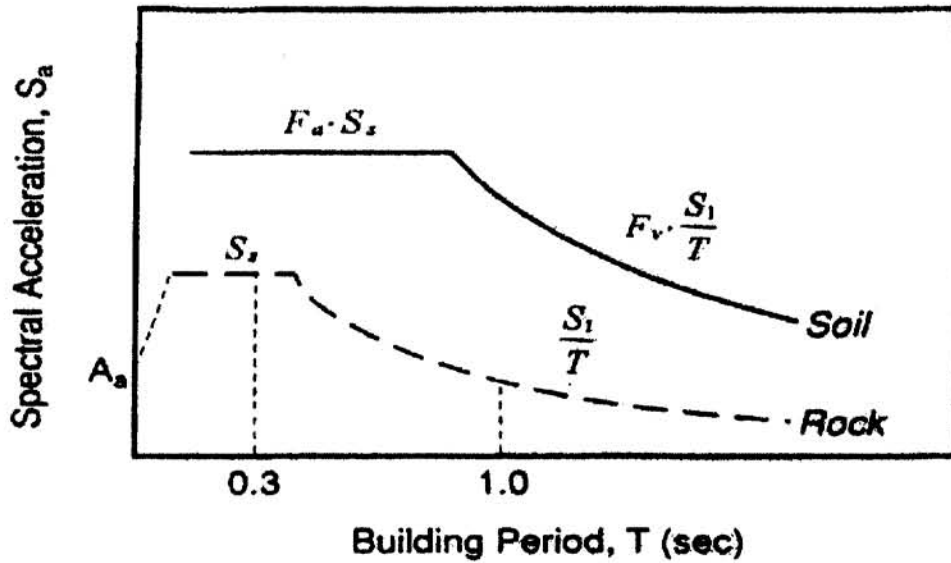

Figure C3.3.2-2. Two-factor approach to local site response.

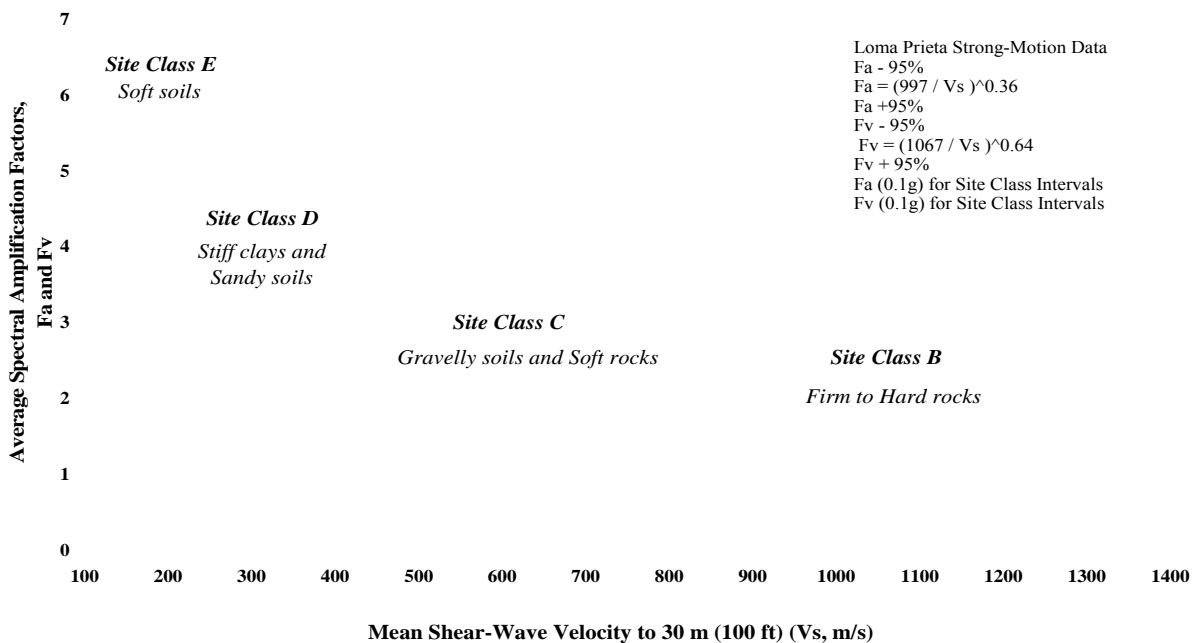

Figure C3.3.2-3. Short-period F_a and long-period F_v site coefficients with respect to site class B (firm to hard rocks) inferred as a continuous function of shear-wave velocity from empirical regression curves derived using Loma Prieta strong-motion recordings. The 95 percent confidence intervals for the ordinate to the true population regression line and the corresponding site coefficients in Tables 3.3-1 and 3.3-2 for 0.1g acceleration are plotted. The curves show that a two factor approach with a short- and a long-period site coefficient is needed to characterize the response of near surface deposits (modified from Borchardt 1994).

The curves in Figure C3.3.2-3 provide empirical estimates of the site coefficients F_a and F_v as a function of mean shear wave velocity for an input peak ground accelerations on rock equal to about 0.1 g (Borchardt, 1994; Borchardt and Glassmoyer, 1994) The empirical amplification factors predicted by these curves are in good agreement with those obtained from empirical analyses of Loma Prieta data

for soft soils by Joyner et al. (1994) shown in Figure 3.3.2-4. These short- and long-period amplification factors for low peak ground (rock) acceleration levels (~ 0.1 g) provided the basis for the values in the left-hand columns of Tables 3.3-1 and 3.3-2. Note that in Tables 3.3-1 and 3.3-2, a peak ground (rock) acceleration of 0.1g corresponds approximately to a response spectral acceleration on rock at 0.2-second period (S_s) equal to 0.25g (Table 3.3-1) and to a response spectral acceleration on rock at 1.0-second period (S_l) equal to 0.1g (Table 3.3-2).

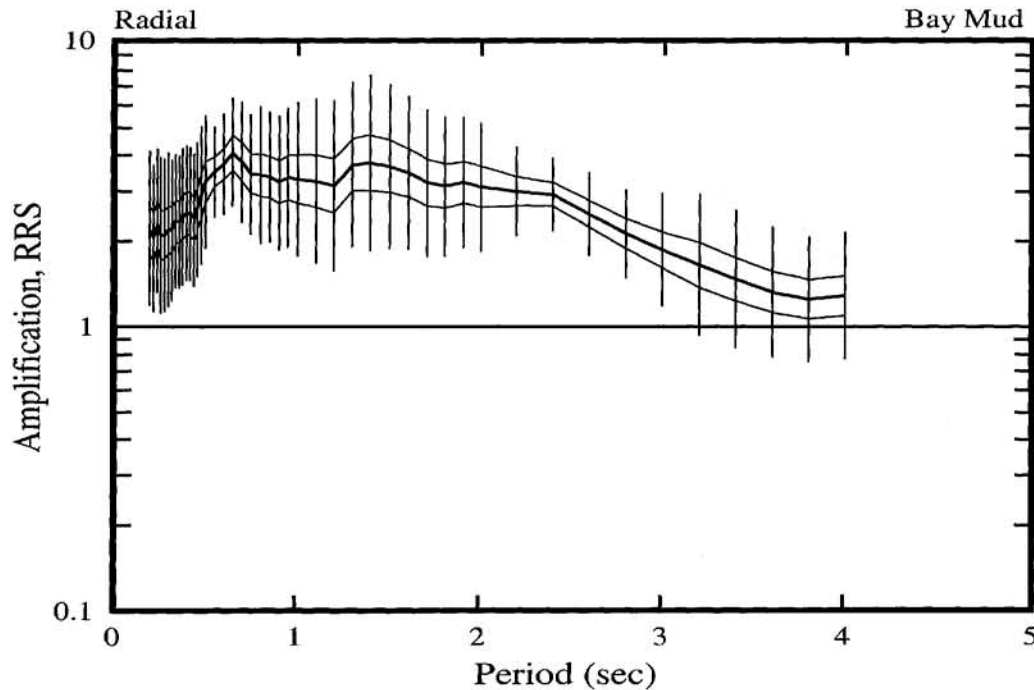

Figure C3.3.2-4. Calculation of average ratios of response spectra (RRS) curves for 5 percent damping from records of 1989 Loma Prieta earthquake on soft soil sites. The middle curve gives the geometric average ratio as function of the period. The top and bottom curves show the range from plus to minus one standard deviation of the average of the logarithms of the ratios. The vertical lines show the range from plus to minus standard deviation of the logarithms of the ratios (Joyner et al., 1994).

The values of F_a and F_v obtained directly from the analysis of ground motion records from the Loma Prieta earthquake were used to calibrate numerical one-dimensional site response analytical techniques, including equivalent linear as well as nonlinear programs. The equivalent linear program SHAKE (Schnabel et al. 1972), which had been shown in previous studies to provide reasonable predictions of soil amplification during earthquakes (e.g., Seed and Idriss 1982), was used extensively for this calibration. Seed et al. (1994) and Dobry et al. (1994) showed that the one-dimensional model provided a good first-order approximation to the observed site response in the Loma Prieta earthquake, especially at soft clay sites. Idriss (1990, 1991) used these analysis techniques to study the amplification of peak ground acceleration on soft soil sites relative to rock sites as a function of the peak acceleration on rock. Results of these studies are shown in Figure 3.3.2-5, illustrating that the large amplifications of peak acceleration on soft soil for low rock accelerations recorded during the 1985 Mexico City earthquake and the 1989 Loma Prieta earthquake should tend to decrease rapidly as rock accelerations increases above about 0.1 g.

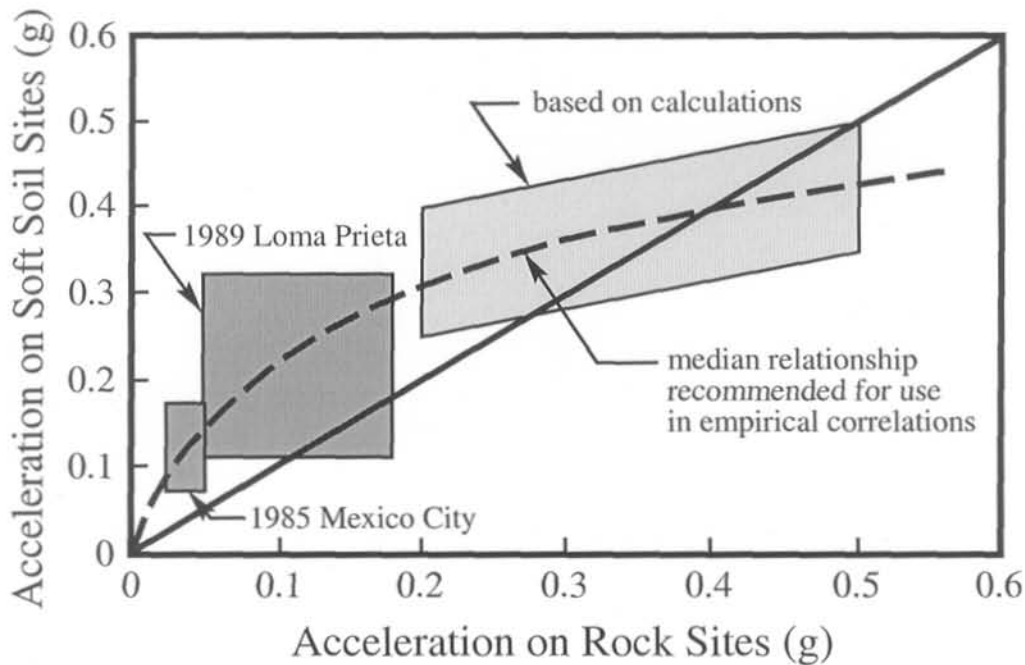

Figure C3.3.2-5. Relationships between maximum acceleration on rock and other local site conditions (Idriss, 1990, 1991).

After calibration, these equivalent linear and nonlinear one-dimensional site response techniques were used to extrapolate the values of F_a and F_v to larger rock accelerations of as much as 0.4g or 0.5g. Parametric studies involving combinations of hundreds of soil profiles and several dozen input earthquake rock motions provided quantitative guidelines for extrapolation of the Loma Prieta earthquake results (Seed et al. 1994; Dobry et al. 1994). Figure C3.3.2-6 summarizes some results of these site response analyses using the equivalent linear method. This figure presents values of peak amplification of response spectra at long periods for soft sites (termed maximum Ratio of Response Spectra, RRS_{max}) calculated using the equivalent linear approach as a function of the plasticity index (PI) of the soil and the rock shear wave velocity V_r for both weak (0.1 g) and strong (0.4 g) input rock shaking. The effect of PI is due to the fact that soils with higher PI exhibit less stress-strain nonlinearity and a lower material damping (Vucetic and Dobry 1991). For peak rock acceleration = 0.1 g, $V_r = 4,000$ ft/sec (1220 m/s) and $PI = 50$, roughly representative of San Francisco Bay area soft sites in the Loma Prieta earthquake, $RRS_{max} = 4.4$, which for a soil shear wave velocity of 150 m/sec coincides with the upper part of the range in Figure 3.3.2-3 inferred from the ground motion records. Note the reduction of this value of RRS_{max} from 4.4 to about 3.3 in Figure C3.3.2-6 when peak rock acceleration = 0.4 g, due to soil nonlinearity. Results such as those in Figure C3.3.2-6 provided the basis for the values of F_a and F_v shown in the right-most four columns of Tables 3.3-1 and 3.3-2.

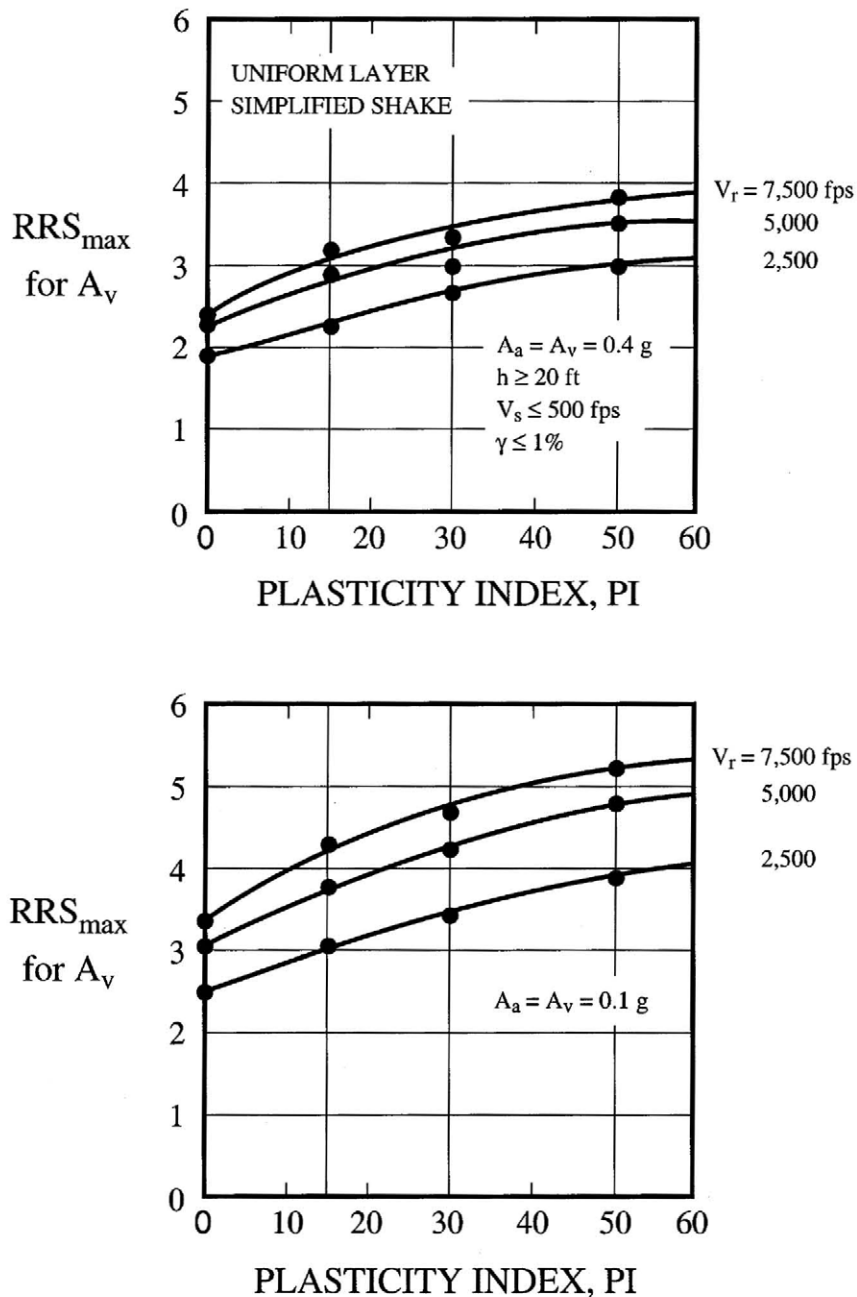

Figure C3.3.2-6. Variation of RRS_{max} of uniform layer of soft clay on rock from equivalent linear site response analyses (Dobry et al., 1994).

Graphs and equations that provide a framework for extrapolation of F_a and F_v from Loma Prieta results to larger input ground motion levels continuously as a function of site conditions (shear-wave velocity) are shown in Figure C3.3.2-7. The site coefficients in Tables 3.3-1 and 3.3-2 are superimposed on this figure. These simple curves were developed to reproduce the site coefficients for site classes E and B and provide approximate estimates of the coefficients for the other Site Classes at various ground acceleration levels. The equations describing the curves indicate that the amplification at a site is proportional to the shear velocity ratio (impedance ratio) with an exponent that varies with the input ground motion level (Borcherdt, 1994).

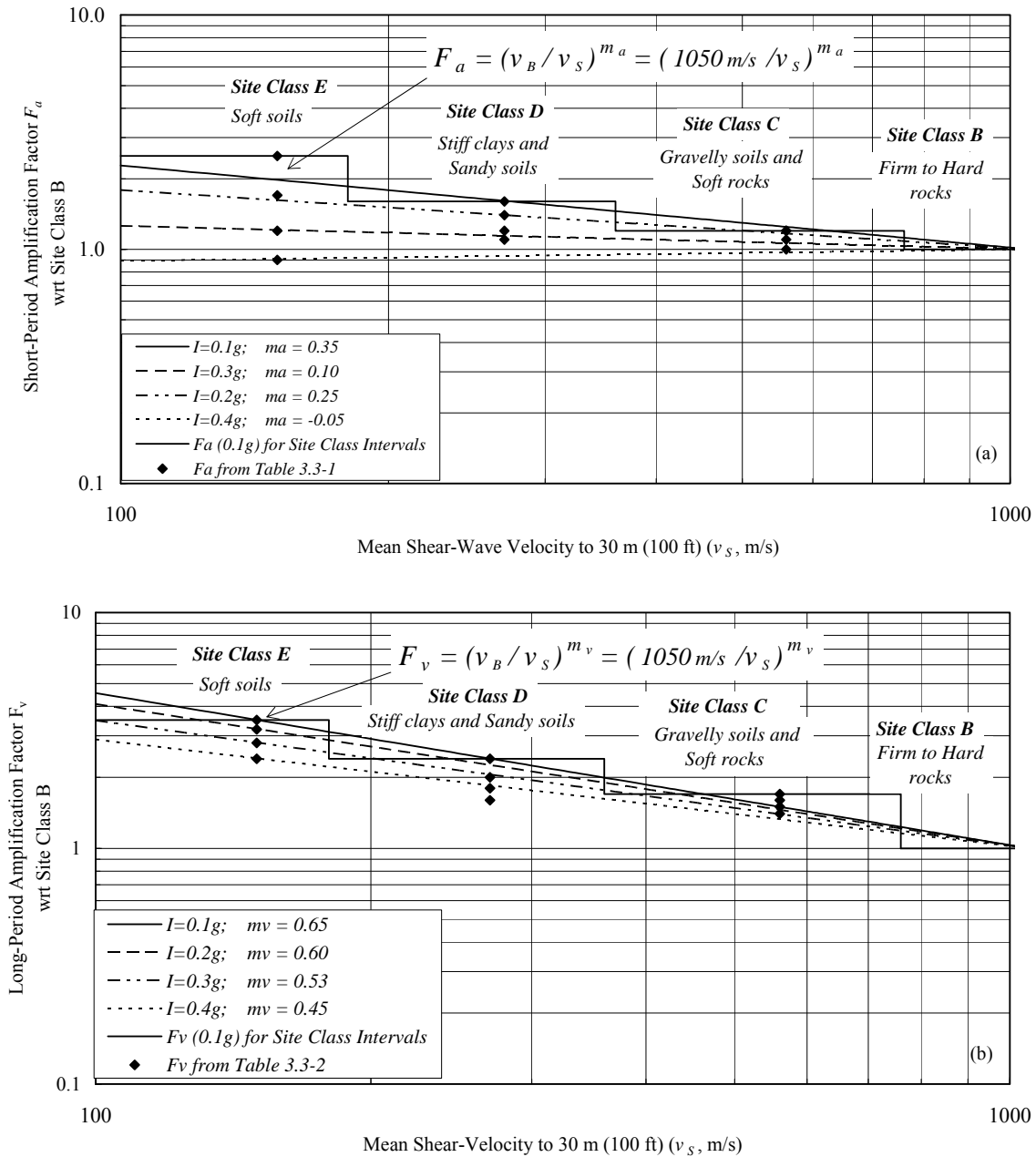

Figure C3.3.2-7. Graphs and equations that provide a simple framework for inference of (a) F_a and (b) F_v values as a continuous function of shear velocity at various input acceleration levels. Site coefficients in Table 3.3-1 and 3.3-2 are superimposed. These simple curves were developed to reproduce the site coefficients for site classes E and B and provide approximate estimates of the coefficients for the other site classes at various ground acceleration levels (from Borcherdt 1994).

A more extensive discussion of the development of site coefficients is presented by Dobry, et al. (2000). Since the development of these coefficients and the development of a community consensus regarding their values in 1992, recent earthquakes have provided additional strong motion data from which to infer site amplifications. Analyses conducted on the basis of these more recent data are reported by a number of researchers, including Crouse and McGuire, 1996; Dobry et al., 1999; Silva et al., 2000; Joyner and Boore, 2000; Field, 2000; Steidl, 2000; Rodriguez-Marek et al., 2001; Borcherdt, 2002, and Stewart et al., 2003. While the results of these studies vary, overall the site amplification

factors are generally consistent with those in Tables 3.3-1 and 3.3.2 and there is no clear consensus for change at the present time (end of 2002).

3.3.4 Design response spectrum. This section provides a general method for obtaining a 5-percent-damped response spectrum from the site design acceleration response parameters S_{aS} and S_{aI} . This spectrum is based on that proposed by Newmark and Hall, as a series of three curves representing in the short period, a region of constant spectral response acceleration; in the long period, a range of constant spectral response velocity; and in the very long period, a range of constant spectral response displacement. Response acceleration at any period in the long period range can be related to the constant response velocity by the equation:

$$S_a = \omega S_v = \frac{2\pi}{T} S_v \quad (\text{C3.3-1})$$

where ω is the circular frequency of motion, T is the period, and S_v is the constant spectral response velocity. Thus the site design spectral response acceleration at 1 second, S_{aI} , is simply related to the constant spectral velocity for the spectrum as follows:

$$S_{aI} = 2\pi S_v \quad (\text{C3.3-2})$$

and the spectral response acceleration at any period in the constant velocity range can be obtained from the relationship:

$$S_a = \frac{S_{DI}}{T} \quad (\text{C3.3-3})$$

The constant displacement domain of the response spectrum is not included on the generalized response spectrum because relatively few structures have a period long enough to fall into this range. Response accelerations in the constant displacement domain can be related to the constant displacement by a $1/T^2$ relationship. Sec. 5.3 of the *Provisions*, which provides the requirements for modal analysis also provides instructions for obtaining response accelerations in the very long period range.

The T_L maps were prepared following a two-step procedure. The first step consisted of establishing a correlation between earthquake magnitude and T_L . This correlation was established by (1) determining the corner period between intermediate and long period motions based on seismic source theory and (2) examining the response spectra of strong motion accelerograms recorded during moderate and large magnitude earthquakes. This corner period, T_c , marks the transition between the constant displacement and constant velocity segments of the Fourier spectrum representing a theoretical fault-rupture displacement history. T_c , which was considered an approximation for T_L , was related to moment magnitude, M , through the formula, $\log T_c = -1.25 + 0.3 M$. This formula was selected from several available formulas based on comparisons of T_c predicted by this equation and T_L estimated from strong motion accelerograms with reliable long period content. The results were used to establish the following half-unit ranges of M for given values of T_c .

M	T_c (sec)
6.0 – 6.5	4
6.5 – 7.0	6
7.0 – 7.5	8
7.5 – 8.0	12
8.0 – 8.5	16
8.5 – 9.0+	20

To determine the T_L values for the U.S., the USGS constructed maps of the modal magnitudes (M_d) in half-unit increments (as shown in the above table). The maps were prepared from a deaggregation of the 2 percent in 50-yr hazard for S_a ($T = 2$ sec), the response spectral acceleration at an oscillator period of 2 sec. (for HI the deaggregation was only available for $T = 1$ sec). The M_d that was computed represented the magnitude interval that had the largest contribution to the 2 percent in 50-yr hazard for S_a .

The M_d maps were judged to be an acceptable approximation to values of M_d that would be obtained if the deaggregation could have been computed at the longer periods of interest. These M_d maps were color coded to more easily permit the eventual construction of the T_L maps. Generally the T_L maps corresponded to the M_d maps, but some smoothing of the boundaries separating T_L regions was necessary to make them more legible. A decision was made to limit the T_L in the broad area in the central and eastern U.S., which had an M_d of 16 sec, to 12 sec. Likewise, the T_L for the areas affected by the great megathrust earthquakes in the Pacific Northwest and Alaska, was limited to 16 sec.

3.4 SITE-SPECIFIC PROCEDURE

The objective in conducting a site-specific ground motion analysis is to develop ground motions that are determined with higher confidence for the local seismic and site conditions than can be determined from national ground motion maps and the general procedure of Sec. 3.3. Accordingly, such studies must be comprehensive and incorporate current scientific interpretations. Because there is typically more than one scientifically credible alternative for models and parameter values used to characterize seismic sources and ground motions, it is important to formally incorporate these uncertainties in a site-specific probabilistic analysis. For example, uncertainties may exist in seismic source location, extent and geometry; maximum earthquake magnitude; earthquake recurrence rate; choices for ground motion attenuation relationships; and local site conditions including soil layering and dynamic soil properties as well as possible two- or three-dimensional wave propagation effects. The use of peer review for a site-specific ground motion analysis is encouraged.

Near-fault effects on horizontal response spectra include (1) directivity effects that increase ground motions for periods of vibration greater than approximately 0.5 second for fault rupture propagating toward the site; and (2) directionality effects that increase ground motions for periods greater than approximately 0.5 second in the direction normal (perpendicular) to the strike of the fault. Further discussion of these effects is contained in Somerville et al. (1997) and Abrahamson (2000).

Conducting site-specific geotechnical investigations and dynamic site response analyses.

Provisions Tables 3.3-1 and 3.3-2 and Sec. 3.5.1 require that site-specific geotechnical investigations and dynamic site response analysis be performed for sites having Site Class F soils. Guidelines are provided below for conducting site-specific investigations and site response analyses for these soils. These guidelines are also applicable if it is desired to conduct dynamic site response analyses for other site classes.

Site-specific geotechnical investigation: For purposes of obtaining data to conduct a site response

analysis, site-specific geotechnical investigations should include borings with sampling, standard penetration tests (SPTs) for sandy soils, cone penetrometer tests (CPTs), and/or other subsurface investigative techniques and laboratory soil testing to establish the soil types, properties, and layering and the depth to rock or rock-like material. For very deep soil sites, the depth of investigation need not necessarily extend to bedrock but to a depth that may serve as the location of input motion for a dynamic site response analysis (see below). It is desirable to measure shear wave velocities in all soil layers. Alternatively, shear wave velocities may be estimated based on shear wave velocity data available for similar soils in the local area or through correlations with soil types and properties. A number of such correlations are summarized by Kramer (1996).

Dynamic site response analysis: Components of a dynamic site response analysis include the following steps:

1. **Modeling the soil profile:** Typically, a one-dimensional soil column extending from the ground surface to bedrock is adequate to capture first-order site response characteristics. For very deep soils, the model of the soil columns may extend to very stiff or very dense soils at depth in the column. Two- or three-dimensional models should be considered for critical projects when two or three-dimensional wave propagation effects should be significant (e.g., in basins). The soil layers in a one-dimensional model are characterized by their total unit weights and shear wave velocities from which low-strain (maximum) shear moduli may be obtained, and by relationships defining the nonlinear shear stress-strain relationships of the soils. The required relationships for analysis are often in the form of curves that describe the variation of soil shear modulus with shear strain (modulus reduction curves) and by curves that describe the variation of soil damping with shear strain (damping curves). In a two- or three-dimensional model, compression wave velocities or moduli or Poisson ratios also are required. In an analysis to estimate the effects of liquefaction on soil site response, the nonlinear soil model also must incorporate the buildup of soil pore water pressures and the consequent effects on reducing soil stiffness and strength. Typically, modulus reduction curves and damping curves are selected on the basis of published relationships for similar soils (e.g., Seed and Idriss, 1970; Seed et al., 1986; Sun et al., 1988; Vucetic and Dobry, 1991; Electric Power Research Institute, 1993; Kramer, 1996). Site-specific laboratory dynamic tests on soil samples to establish nonlinear soil characteristics can be considered where published relationships are judged to be inadequate for the types of soils present at the site. Shear and compression wave velocities and associated maximum moduli should be selected on the basis of field tests to determine these parameters or published relationships and experience for similar soils in the local area. The uncertainty in soil properties should be estimated, especially the uncertainty in the selected maximum shear moduli and modulus reduction and damping curves.
2. **Selecting input rock motions:** Acceleration time histories that are representative of horizontal rock motions at the site are required as input to the soil model. Unless a site-specific analysis is carried out to develop the rock response spectrum at the site, the maximum considered earthquake (MCE) rock spectrum for Site Class B rock can be defined using the general procedure described in Sec. 3.3. For hard rock (Site Class A), the spectrum may be adjusted using the site factors in Tables 3.3-1 and 3.3-2. For profiles having great depths of soil above Site Class A or B rock, consideration can be given to defining the base of the soil profile and the input rock motions at a depth at which soft rock or very stiff soil of Site Class C is encountered. In such cases, the MCE rock response spectrum may be taken as the spectrum for Site Class C defined using the site factors in Tables 3.3-1 and 3.3-2. Several acceleration time histories of rock motions, typically at least four, should be selected for site response analysis. These time histories should be selected after evaluating the types of earthquake sources, magnitudes, and distances that predominantly contribute to the seismic hazard at the site. Preferably, the time histories selected for analysis should have been recorded on geologic materials similar to the site class of materials at the base of the site soil profile during earthquakes of similar types (e.g. with respect to tectonic environment and type of faulting), magnitudes, and distances as those predominantly contributing to the site

seismic hazard. The U.S. Geological Survey national seismic hazard mapping project website (<http://geohazards.cr.usgs.gov/eq/>) includes hazard deaggregation options and can be used to evaluate the predominant types of earthquake sources, magnitudes, and distances contributing to the hazard. Sources of recorded acceleration time histories include the data bases of the Consortium of Organizations for Strong Motion Observation Systems (COSMOS) Virtual Data Center web site (db.cosmos-eq.org) and the Pacific Earthquake Engineering Research Center (PEER) Strong Motion Data Base website (<http://peer.berkeley.edu/smcat/>). Prior to analysis, each time history should be scaled so that its spectrum is at the approximate level of the MCE rock response spectrum in the period range of interest. It is desirable that the average of the response spectra of the suite of scaled input time histories be approximately at the level of the MCE rock response spectrum in the period range of interest. Because rock response spectra are defined at the ground surface rather than at depth below a soil deposit, the rock time histories should be input in the analysis as outcropping rock motions rather than at the soil-rock interface.

3. Site response analysis and results interpretation: Analytical methods may be equivalent linear or nonlinear. Frequently used computer programs for one-dimensional analysis include the equivalent linear program SHAKE (Schnabel et al., 1972; Idriss and Sun, 1992) and the nonlinear programs DESRA-2 (Lee and Finn, 1978), MARDES (Chang et al., 1991), SUMDES (Li et al., 1992), D-MOD (Matasovic, 1993), TESS (Pyke, 1992), and DESRAMUSC (Qiu, 1998). If the soil response is highly nonlinear (e.g., high acceleration levels and soft soils), nonlinear programs may be preferable to equivalent linear programs. For analysis of liquefaction effects on site response, computer programs incorporating pore water pressure development (effective stress analyses) must be used (e.g., DESRA-2, SUMDES, D-MOD, TESS, and DESRAMUSC). Response spectra of output motions at the ground surface should be calculated and the ratios of response spectra of ground surface motions to input outcropping rock motions should be calculated. Typically, an average of the response spectral ratio curves is obtained and multiplied by the MCE rock response spectrum to obtain a soil response spectrum. Sensitivity analyses to evaluate effects of soil property uncertainties should be conducted and considered in developing the design response spectrum.

3.4.2 Deterministic maximum considered earthquake. It is required that ground motions for the deterministic maximum considered earthquake be based on characteristic earthquakes on all known active faults in a region. As defined in Sec. 3.1.3, the magnitude of a characteristic earthquake on a given fault should be a best-estimate of the maximum magnitude capable for that fault but not less than the largest magnitude that has occurred historically on the fault. The maximum magnitude should be estimated considering all seismic-geologic evidence for the fault, including fault length and paleoseismic observations. For faults characterized as having more than a single segment, the potential for rupture of multiple segments in a single earthquake should be considered in assessing the characteristic maximum magnitude for the fault.

3.5 SITE CLASSIFICATION FOR SEISMIC DESIGN

3.5.1 Site Class Definitions. Based on the studies and observations discussed in Sec. 3.3-2, the site categories in the 2003 *Provisions* are defined in terms of the small-strain shear wave velocity in the top 100 ft (30 m) of the profile, \bar{v}_s , as might be inferred from travel time for a shear wave to travel from the surface to a depth of 100 ft (30m). If shear wave velocities are available for the site, they should be used to classify the site.

However, in recognition of the fact that in many cases the shear wave velocities are not available, alternative definitions of the site classes also are included in the 2003 *Provisions*. They use the standard penetration resistance for cohesionless and cohesive soils and rock and the undrained shear strength for cohesive soils only. These alternative definitions are rather conservative since the correlation between site amplification and these geotechnical parameters is more uncertain than the correlation with \bar{v}_s . That is, there will be cases where the values of F_a and F_v will be smaller if the site

category is based on \bar{v}_s , rather than on the geotechnical parameters. Also, the site category definitions should not be interpreted as implying any specific numerical correlation between shear-wave velocity and standard penetration resistance or shear strength.

Equation 3.5-1 is for inferring the average shear-wave velocity to a depth of 100 ft (30m) at a site. Equation 3.5-1 specifies that the average velocity is given by the sum of the thicknesses of the geologic layers in the upper 100 ft divided by the sum of the times for a shear wave to travel through each layer, where travel time for each layer is specified by the ratio of the thickness and the shear wave velocity for the layer. It is important that this method of averaging be used as it may result in a significantly lower effective average shear wave velocity than the velocity that would be obtained by averaging the velocities of the individual layers directly.

Equation 3.5-2 is for classifying the site using the standard penetration resistance (N -value) for cohesionless soils, cohesive soils, and rock in the upper 100 ft (30 m). A method of averaging analogous to the method of Equation 3.5-1 for shear wave velocity is used. The maximum value of N that can be used for any depth of measurement in soil or rock is 100 blows/ft.

Equations 3.5-3 and 3.5-4 are for classifying the site using the standard penetration resistance of cohesionless soil layers, N_{ch} , and the undrained shear strength of cohesive soil layers, s_u , within the top 100 ft (30 m). These equations are provided as an alternative to using Eq. 3.5-2 for which N -values in all geologic materials in the top 100 ft (30 m) are used. When using Eq. 3.5-3 and 3.5-4, only the thicknesses of cohesionless soils and cohesive soils within the top 100 ft (30 m) are used.

As indicated in Sec. 3.3-2 and 3.5-1, soils classified as Site Class F according to the definitions in Sec. 3.5-1 require site-specific evaluations. An exception is made, however, for liquefiable sites where the structure has a fundamental period of vibration equal to or less than 0.5 second. For such structures, values of F_a and F_v for the site may be determined using the site class definitions and criteria in Sec. 3.5-1 assuming liquefaction does not occur. The exception is provided because ground motion data obtained in liquefied soil areas during earthquakes indicate that short-period ground motions are generally attenuated due to liquefaction whereas long-period ground motions may be amplified. This exception is only for the purposes of defining the site class and obtaining site coefficients. It is still required to assess liquefaction potential and its effects on structures as a ground failure hazard as specified in Chapter 7.

3.5.2 Steps for classifying a site. A step-by-step procedure for classifying a site is given in the *Provisions*. Although the procedure and criteria in Sec. 3.5.1 and 3.5.2 are straightforward, there are aspects of these assessments that may require additional judgment and interpretation. Highly variable subsurface conditions beneath a building footprint could result in overly conservative or unconservative site classification. Isolated soft soil layers within an otherwise firm soil site may not affect the overall site response if the predominant soil conditions do not include such strata. Conversely, site response studies have shown that continuous, thin, soft clay strata may increase the site amplification.

The site class should reflect the soil conditions that will affect the ground motion input to the structure or a significant portion of the structure. For structures receiving substantial ground motion input from shallow soils (e.g. structures with shallow spread footings, laterally flexible piles, or structures with basements where it is judged that substantial ground motion input to the structure may come through the side walls), it is reasonable to classify the site on the basis of the top 100 ft (30 m) of soils below the ground surface. Conversely, for structures with basements supported on firm soils or rock below soft soils, it is reasonable to classify the site on the basis of the soils or rock below the mat, if it can be justified that the soft soils contribute very little to the response of the structure.

Buildings on sloping bedrock sites and/or having highly variable soil deposits across the building area require careful study since the input motion may vary across the building (for example, if a portion of the building is on rock and the rest is over weak soils). Site-specific studies including two- or three-

dimensional modeling may be appropriate in such cases to evaluate the subsurface conditions and site and superstructure response. Other conditions that may warrant site-specific evaluation include the presence of low shear wave velocity soils below a depth of 100 ft (30 m), location of the site near the edge of a filled-in basin, or other subsurface or topographic conditions with strong two- and three-dimensional site-response effects. Individuals with appropriate expertise in seismic ground motions should participate in evaluations of the need for and nature of such site-specific studies.

REFERENCES

- Abrahamson, N.A., 2000, Effects of rupture directivity on probabilistic seismic hazard analysis: Proceedings, Sixth International Conference on Seismic Zonation, Palm Springs, California.
- Borcherdt, R.D., 2002, Empirical evidence for site coefficients in building-code provisions, *Earthquake Spectra*, Earthquake Engineering Research Institute, v. 18, No. 2, p. 189-217.
- Borcherdt, R.D., 1994, Estimates of site-dependent response spectra for design (methodology and justification), *Earthquake Spectra*, 10, 617-653, (Simplified site classes and empirical amplification factors for site dependent code provisions, Proceedings of the 1992 NCEER/SEAOC/BSSC Workshop on Site Response During Earthquakes and Seismic Code Provisions, G.R. Martin, ed., University of Southern California, Los Angeles, November 18-20, 1992, National Center for Earthquake Engineering Research Special Publication NCEER-94-SP01, Buffalo, New York).
- Borcherdt, R.D., and Glassmoyer, G., 1994, Influences of local geology on strong and weak ground motions in the San Francisco Bay region, California, and their implications for site-specific code provisions, in *The Loma Prieta Earthquake of October 17, 1989 – Strong Ground Motion*, R.D. Borcherdt, ed., *U.S. Geological Survey Professional Paper 1551-A*, A77-A108.
- Chang, C.-Y., C. M. Mok, M. S. Power, and Y. K. Tang. 1991. *Analysis of Ground Response at Lotung Large-Scale Soil-Structure Interaction Experiment Site*, Report NP-7306-SL. Palo Alto, California: Electric Power Research Institute.
- Crouse, C.B., and McGuire, J.W., 1996, Site response studies for purposes of revising NEHRP Seismic Provisions, *Earthquake Spectra*, Earthquake Engineering Research Institute, v. 12, no. 3.
- Dobry, R., Ramos, R., and Power, M.S., 1999, Site factors and site categories in seismic codes, Technical Report MCEER-99-0010, Multidisciplinary Center for Earthquake Engineering Research.
- Dobry, R., Borcherdt, R., Crouse, C.B., Idriss, I.M., Joyner, W.B., Martin, G.R., Power, M.S., Rinne, E.E., Seed, R.B., 2000, New Site coefficients and site classifications system used in recent building seismic code provisions, *Earthquake Spectra* 16 (1); 41-67.
- Dobry, R., Martin, G. R., Parra, E., and Bhattacharyya, A., 1994, Development of site-dependent ratios of elastic response spectra (RRS) and site categories for building seismic codes, *Proceedings of the 1992 NCEER/SEAOC/BSSC Workshop on Site Response During Earthquakes and Seismic Code Provisions*, G.R. Martin, ed., University of Southern California, Los Angeles, November 18-20, 1992, National Center for Earthquake Engineering Research Special Publication NCEER-94-SP01, Buffalo, NY.
- Electric Power Research Institute. 1993. *Guidelines for Determining Design Basis Ground Motions*, Report EPRI TR-102293. Palo Alto, California.
- Field, E.H., 2000, A modified ground motion attenuation relationship for southern California that accounts for detailed site classification and a basin depth effect, *Bulletin of the Seismological Society of America*, 90, S209-S221.
- Housner, G.W., 1990, Competing against time: Report to Governor George Duekmejian from the Governor's Board of Inquiry on the 1989 Loma Pireta earthquake, May.
- Idriss, I. M. 1990, "Response of Soft Soil Sites During Earthquakes." In *Proceedings of the*

Symposium to Honor Professor H. B. Seed, Berkeley, May, 273-289.

Idriss, I.M., 1991, Earthquake ground motions at soft soil sites, *Proceedings of the Second International Conference on Recent Advances in Geotechnical Earthquake Engineering and Soil Dynamics*, St. Louis, MO, III, 2265-2273.

Idriss, I. M., and Sun, J.I., 1992. *User's Manual for SHAKE91*. Davis: Center for Geotechnical Modeling, Department of Civil and Environmental Engineering, University of California.

Joyner, W.B., and Boore, D.M., 2000, Recent developments in earthquake ground motion estimation, Proceeding 6th International Conference on Seismic Zonation, Palm Springs.

Joyner, W.B., Fumal, T.E., and Glassmoyer, G., 1994, Empirical spectral response ratios for strong motion data from the 1989 Loma Prieta, California earthquake, *Proceedings for the 1992 NCEER/SEAOC/BSSC Workshop on Site Response During Earthquakes and Seismic Code Provisions*, G.R. Martin, ed., University of Southern California, Los Angeles, November 18-20, 1992, National Center for Earthquake Engineering Research Special Publication *NCEER-94-SP01*, Buffalo, NY.

Kramer, S. L., 1996. *Geotechnical Earthquake Engineering*. New Jersey: Prentice Hall.

Lee, M. K. W., and W. D. L. Finn. 1978. *DESRA-2, Dynamic Effective Stress Response Analysis of Soil Deposits with Energy Transmitting Boundary Including Assessment of Liquefaction Potential, Soil Mechanics Series 36*. Vancouver, Canada: Department of Civil Engineering, University of British Columbia.

Li, X. S., Z. L. Wang, and C. K. Shen. 1992. *SUMDES, A Nonlinear Procedure for Response Analysis of Horizontally-Layered Sites Subjected to Multi-Directional Earthquake Loading*. Davis: Department of Civil Engineering, University of California.

Matasovic, N. 1993. Seismic Response of Composite Horizontally-Layered Soil Deposits, Ph.D. dissertation, Civil and Environmental Engineering Department, University of California, Los Angeles.

Qiu, P., 1998, Earthquake-induced nonlinear ground deformation analyses: Ph.D. dissertation, University of Southern California, Los Angeles.

Pyke, R. M. 1992. *TESS: A Computer Program for Nonlinear Ground Response Analyses*. Lafayette, California: TAGA Engineering Systems and Software.

Rodriguez-Marek, A., Bray, J.D., Abrahamson, N., 2001, An empirical geotechnical site response procedure, *Earthquake Spectra*, Earthquake Engineering Research Institute, v. 17, No. 1, p. 65-87.

Schnabel, P.B., Lysmer, J., and Seed, H.B., 1972, SHAKE: A computer program for earthquake response analysis of horizontally layered sites, *Report EERC 72-12*, Earthquake Engineering Research Center, University of California, Berkeley, CA.

Seed, R. B. Dickenson, S.E., Rau, G.A., White, R.K., and Mok, C.M., 1994, Observations regarding seismic response analyses for soft and deep clay sites, *Proceedings of the 1992 NCEER/SEAOC/BSSC Workshop on Site Response During Earthquakes and Seismic Code Provisions*, G.R. Martin, ed., University of Southern California, Los Angeles, November 18-20, 1992, National Center for Earthquake Engineering Research Special Publication *NCEER-94-SP01*, Buffalo, NY.

Seed, H.B., and Idriss, I.M., 1982, Ground motions and soil liquefaction during earthquakes, *EERI Monograph Series*, Earthquake Engineering Research Institute, Berkeley, CA.

Seed, H.B., R. T. Wong, I. M. Idriss, and K. Tokimatsu. 1986. "Moduli and Damping Factors for Dynamic Analyses of Cohesionless Soils," *Journal of Geotechnical Engineering*, ASCE, Vol. 112, No. 11: 1016-1032.

Seed, H.B., and I. M. Idriss. 1970, *Soil Moduli and Damping Factors for Dynamic Response Analyses*, Report EERC 70-10. Berkeley: University of California, Earthquake Engineering Research Center.

Silva, W., Darragh, R., Gregor, N., Martin, G., Abrahamson, N., and Kircher, C., 2000, Reassessment of site coefficients and near-fault factors for building code provisions; Program Element: II, 98-HQ-GR-1010, Report to USGS.

Somerville, P.G., Smith, N.F., Graves, R.W., and Abrahamson, N.A., 1997, Modification of empirical strong ground motion attenuation relations to include the amplitude and duration effects of rupture directivity: *Seismological Research Letters*, v. 68, p. 199-222.

Stewart, J.P., Liu, A.H., and Choi, Y., 2003, Amplification factors for spectral acceleration in tectonically active regions, *Bulletin of the Seismological Society of America*, 93(1), 332-352.

Steidl, J.H., 2000, Site response in southern California for probabilistic seismic hazard analysis, *Bulletin of the Seismological Society of America*, 90, S149-S169.

Sun, J. I., R. Goleorkhi, and H. B. Seed. 1988. *Dynamic Moduli and Damping Ratios for Cohesive Soils*, Report UBC/EERC-88/15. Berkeley: University of California, Earthquake Engineering Research Center.

Vucetic, M., and R. Dobry. 1991. "Effect of Soil Plasticity on Cyclic Response," *Journal of Geotechnical Engineering*, ASCE, Vol. 117, No. 1: 89-107.

This page is intentionally left blank.

Chapter 4 Commentary

STRUCTURAL DESIGN CRITERIA

4.1 GENERAL

4.1.2 References. ASCE 7 is referenced for the combination of earthquake loadings with other loads as well as for the computation of other loads; it is not referenced for the computation of earthquake loads.

4.2 GENERAL REQUIREMENTS

4.2.1 Design basis. Structural design for acceptable seismic resistance includes:

1. The selection of gravity- and seismic-force-resisting systems that are appropriate to the anticipated intensity of ground shaking;
2. Layout of these systems such that they provide a continuous, regular, and redundant load path capable of ensuring that the structures act as integral units in responding to ground shaking; and
3. Proportioning the various members and connections such that adequate lateral and vertical strength and stiffness is present to limit damage in a design earthquake to acceptable levels.

In the *Provisions*, the proportioning of structural elements (sizing of individual members, connections, and supports) is typically based on the distribution of internal forces computed based on linear elastic response spectrum analyses using response spectra that are representative of, but substantially reduced from the anticipated design ground motions. As a result, under the severe levels of ground shaking anticipated for many regions of the nation, the internal forces and deformations produced in most structures will substantially exceed the point at which elements of the structures start to yield or buckle and behave in an inelastic manner. This approach can be taken because historical precedent and the observation of the behavior of structures that have been subjected to earthquakes in the past demonstrates that if suitable structural systems are selected and structures are detailed with appropriate levels of ductility, regularity, and continuity, it is possible to perform an elastic design of structures for reduced forces and still achieve acceptable performance. Therefore, these procedures adopt the approach of proportioning structures such that under prescribed design lateral forces that are significantly reduced, by the response modification coefficient R , from those that would actually be produced by a design earthquake they will not deform beyond a point of significant yield. The elastic deformations calculated under these reduced design forces are then amplified, by the deflection amplification factor C_d to estimate the expected deformations likely to be experienced in response to the design ground motion. (Use of the deflection amplification factor is specified in Sec. 5.2.6.1.) Considering the intended structural performance and acceptable deformation levels, Sec. 4.5.1 prescribes the story drift limits for the expected (amplified) deformations. These procedures differ from those in earlier codes and design provisions wherein the drift limits were treated as a serviceability check.

The term “significant yield” is not the point where first yield occurs in any member but, rather, is defined as that level causing complete plastification of at least the most critical region of the structure (such as formation of a first plastic hinge in the structure). A structural steel frame comprising compact members is assumed to reach this point when a “plastic hinge” develops in the most highly stressed member of the structure. A concrete frame reaches significant yield when at least one of the sections of its most highly stressed component reaches its strength as set forth in Chapter 9. These requirements contemplate that the design includes a seismic-force-resisting system with redundant characteristics wherein significant structural overstrength above the level of significant yield can be obtained by plastification at other points in the structure prior to the formation of a complete mechanism. For example, Figure C4.2-1 shows the

lateral load-deflection curve for a typical structure. Significant yield is the level where plastification occurs

at the most heavily loaded element in the structure, shown as the lowest yield hinge on the load-deflection diagram. With increased loading, causing the formation of additional plastic hinges, the capacity increases (following the solid curve) until a maximum is reached. The overstrength capacity obtained by this continued inelastic action provides the reserve strength necessary for the structure to resist the extreme motions of the actual seismic forces that may be generated by the design ground motion.

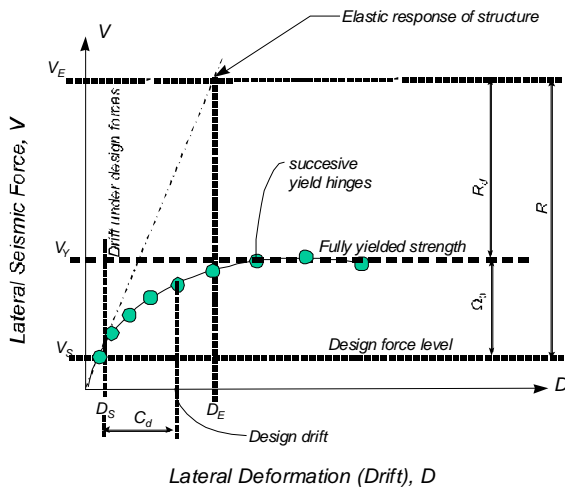

Figure C4.2-1 Inelastic force-deformation curve.

design loading. Third, designers themselves introduce additional overstrength by selecting sections or specifying reinforcing patterns that exceed those required by the computations. Similar situations occur when minimum requirements of the *Provisions*, for example, minimum reinforcement ratios, control the design. Finally, the design of many flexible structural systems, such as moment resisting frames, are often controlled by the drift rather than strength limitations of the *Provisions*, with sections selected to control lateral deformations rather than provide the specified strength. The results is that structures typically have a much higher lateral resistance than specified as a minimum by the *Provisions* and first actual significant yielding of structures may occur at lateral load levels that are 30 to 100 percent higher than the prescribed design seismic forces. If provided with adequate ductile detailing, redundancy, and regularity, full yielding of structures may occur at load levels that are two to four times the prescribed design force levels.

Figure C4.2-1 indicates the significance of design parameters contained in the *Provisions* including the response modification coefficient, R , the deflection amplification factor, C_d , and the structural overstrength coefficient Ω_0 . The values of the response modification coefficient, R , structural overstrength coefficient, Ω_0 , and the deflection amplification factor, C_d , provided in Table 4.3-1, as well as the criteria for story drift, including P -delta effects, have been established considering the characteristics of typical properly designed structures. If excessive “optimization” of a structural design is performed, with lateral resistance provided by only a few elements, the successive yield hinge behavior depicted in Figure C4.2-1 will not be able to form and the values of the design parameters contained in the *Provisions* may not be adequate to provide the intended seismic performance.

The response modification coefficient, R , essentially represents the ratio of the forces that would develop under the specified ground motion if the structure had an entirely linearly elastic response to the prescribed design forces (see Figure C4.2-1). The structure is to be designed so that the level of significant yield exceeds the prescribed design force. The ratio R , expressed by the equation:

It should be noted that the structural overstrength described above results from the development of sequential plastic hinging in a properly designed, redundant structure. Several other sources will further increase structural overstrength. First, material overstrength (that is, actual material strengths higher than the nominal material strengths specified in the design) may increase the structural overstrength significantly. For example, a recent survey shows that the mean yield strength of A36 steel is about 30 to 40 percent higher than the minimum specified strength, which is used in design calculations. Second, member design strengths usually incorporate a strength reduction (or resistance) factor, ϕ , to ensure a low probability of failure under

$$R = \frac{V_E}{V_S} \quad (\text{C4.2-1})$$

is always larger than 1.0; thus, all structures are designed for forces smaller than those the design ground motion would produce in a structure with completely linear-elastic response. This reduction is possible for a number of reasons. As the structure begins to yield and deform inelastically, the effective period of response of the structure tends to lengthen, which for many structures, results in a reduction in strength demand. Furthermore, the inelastic action results in a significant amount of energy dissipation, also known as hysteretic damping, in addition to the viscous damping. The combined effect, which is also known as the ductility reduction, explains why a properly designed structure with a fully yielded strength (V_Y in Figure C4.2-1) that is significantly lower than the elastic seismic force demand (V_E in Figure C4.2-1) can be capable of providing satisfactory performance under the design ground motion excitations. Defining a system ductility reduction factor R_d as the ratio between V_E and V_Y (Newmark and Hall, 1981):

$$R_d = \frac{V_E}{V_Y} \quad (\text{C4.2-2})$$

then it is clear from Figure C4.2-1 that the response modification coefficient, R , is the product of the ductility reduction factor and structural overstrength factor (Uang, 1991):

$$R = R_d \Omega_0 \quad (\text{C4.2-3})$$

The energy dissipation resulting from hysteretic behavior can be measured as the area enclosed by the force-deformation curve of the structure as it experiences several cycles of excitation. Some structures have far more energy dissipation capacity than do others. The extent of energy dissipation capacity available is largely dependent on the amount of stiffness and strength degradation the structure undergoes as it experiences repeated cycles of inelastic deformation. Figure C4.2-2 indicates representative load-deformation curves for two simple substructures, such as a beam-column assembly in a frame. Hysteretic curve (a) in the figure is representative of the behavior of substructures that have been detailed for ductile behavior. The substructure can maintain nearly all of its strength and stiffness over a number of large cycles of inelastic deformation. The resulting force-deformation “loops” are quite wide and open, resulting in a large amount of energy dissipation capacity. Hysteretic curve (b) represents the behavior of a substructure that has not been detailed for ductile behavior. It rapidly loses stiffness under inelastic deformation and the resulting hysteretic loops are quite pinched. The energy dissipation capacity of such a substructure is much lower than that for the substructure (a). Structural systems with large energy dissipation capacity have larger R_d values, and hence are assigned higher R values, resulting in design for lower forces, than systems with relatively limited energy dissipation capacity.

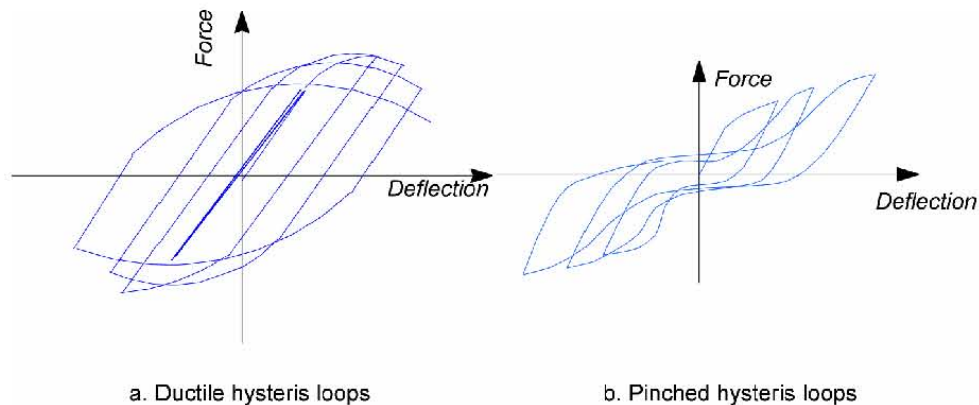

Figure C4.2-2 Typical hysteretic curves.

Some contemporary building codes, including those adopted in Canada and Europe have attempted to directly quantify the relative contribution of overstrength and inelastic behavior to the permissible

reduction in design strength. Recently, the Structural Engineers Association of California proposed such an approach for incorporation into the 1997 *Uniform Building Code*. That proposal incorporated two R factor components, termed R_o and R_d , to represent the reduction due to structural overstrength and inelastic behavior, respectively. The design forces are then determined by forming a composite R , equal to the product of the two components (see Eq. C4.2-3). A similar approach was considered for adoption into the 1997 *NEHRP Provisions*. However, this approach was not taken for several reasons. While it was acknowledged that both structural overstrength and inelastic behavior are important contributors to the R coefficients and that they can be quantified for individual structures, it was felt that there was insufficient research available at the current time to support implementation in the *Provisions*. In addition, there was concern that there can be significant variation between structures in the relative contribution of overstrength and inelastic behavior and that, therefore, this would prevent accurate quantification on a system-by-system basis. Finally, it was felt that this would introduce additional complexity into the *Provisions*. While it was decided not to introduce the split R value concept into the *Provisions* in the 1997 update cycle, this should be considered in the future as additional research on the inelastic behavior of structures becomes available and as the sophistication of design offices improves to the point that quantification of structural overstrength can be done as a routine part of the design process. As a first step in this direction, however, the factor Ω_o was added to Table 4.3-1, to replace the previous $2R/5$ factor used for evaluation of brittle structural behavior modes in previous editions of the *Provisions*.

The R values, contained in the current *Provisions*, are largely based on engineering judgment of the performance of the various materials and systems in past earthquakes. The values of R must be chosen and used with careful judgment. For example, lower values must be used for structures possessing a low degree of redundancy wherein all the plastic hinges required for the formation of a mechanism may be formed essentially simultaneously and at a force level close to the specified design strength. This situation can result in considerably more detrimental P -delta effects. Since it is difficult for individual designers to judge the extent to which R factors should be adjusted based on the inherent redundancy of their designs, a coefficient, ρ , which is calculated based on the amount of the total lateral force resisted by any individual element, is found in *Provisions* in Sec. 4.3.3. Additional discussion of this issue is contained in that section.

In a departure from previous editions of the *Provisions*, the 1997 edition introduced an importance factor I into the base shear equation, which factor varies for different types of occupancies. This importance factor has the effect of adjusting the permissible response modification factor, R , based on the desired seismic performance for the structure. It recognizes that greater levels of inelastic behavior, correspond to increased structural damage. Thus, introducing the importance factor, I , allows for a reduction of the R value to an effective value R/I as a partial control on the amount of damage experienced by the structure under a design earthquake. Strength alone is not sufficient to obtain enhanced seismic performance. Therefore, the improved performance characteristics desired for more critical occupancies are also obtained through application of the design and detailing requirements set forth in Sec. 4.6 for each Seismic Design Category and the more stringent drift limits in Table 4.5-1. These factors, in addition to strength, are extremely important to obtaining the seismic performance desired for buildings in some Seismic Use Groups.

Sec. 4.2.1 in effect calls for the seismic design to be complete and in accordance with the principles of structural mechanics. The loads must be transferred rationally from their point of origin to the final points of resistance. This should be obvious but it often is overlooked by those inexperienced in earthquake engineering.

Design consideration should be given to potentially adverse effects where there is a lack of redundancy. Because of the many unknowns and uncertainties in the magnitude and characteristics of earthquake loading, in the materials and systems of construction for resisting earthquake loadings, and in the methods of analysis, good earthquake engineering practice has been to provide as much redundancy as possible in the seismic-force-resisting system of buildings.

Redundancy plays an important role in determining the ability of the building to resist earthquake forces. In a structural system without redundant components, every component must remain operative to preserve the integrity of the building structure. On the other hand, in a highly redundant system, one or more redundant components may fail and still leave a structural system that retains its integrity and can continue to resist lateral forces, albeit with diminished effectiveness.

Redundancy often is accomplished by making all joints of the vertical load-carrying frame moment resisting and incorporating them into the seismic-force-resisting system. These multiple points of resistance can prevent a catastrophic collapse due to distress or failure of a member or joint. (The overstrength characteristics of this type of frame were discussed earlier in this section.)

The designer should be particularly aware of the proper selection of R when using only one or two one-bay rigid frames in one direction for resisting seismic loads. A single one-bay frame or a pair of such frames provides little redundancy so the designer may wish to consider a modified (smaller) R to account for a lack of redundancy. As more one-bay frames are added to the system, however, overall system redundancy increases. The increase in redundancy is a function of frame placement and total number of frames.

Redundant characteristics also can be obtained by providing multiple different types of seismic-force-resisting systems in a building. The backup system can prevent catastrophic effects if distress occurs in the primary system.

In summary, it is good practice to incorporate redundancy into the seismic-force-resisting system and not to rely on any system wherein distress in any member may cause progressive or catastrophic collapse.

4.2.2 Combination of load effects. The load combination statements in the *Provisions* combine the effects of structural response to horizontal and vertical ground accelerations. They do not show how to combine the effect of earthquake loading with the effects of other loads. For those combinations, the user is referred to ASCE 7. The pertinent combinations are:

$$\begin{array}{ll} 1.2D + 1.0E + 0.5L + 0.2S & \text{(Additive)} \\ 0.9D + 1.0E & \text{(Counteracting)} \end{array}$$

where D , E , L , and S are, respectively, the effects of dead, earthquake, live, and snow loads.

The design basis expressed in Sec. 4.2.1 reflects the fact that the specified earthquake loads are at the design level without amplification by load factors; thus, for sufficiently redundant structures, a load factor of 1.0 is assigned to the earthquake load effects in Eq. 4.2-1 and 4.2-2.

4.2.2.1 Seismic load effect. In Eq. 4.2-1 and 4.2-2, a factor of $0.2S_{DS}$ was placed on the dead load to account for the effects of vertical acceleration. The $0.2S_{DS}$ factor on dead load is not intended to represent the total vertical response. The concurrent maximum response of vertical accelerations and horizontal accelerations, direct and orthogonal, is unlikely and, therefore, the direct addition of responses was not considered appropriate.

The ρ factor was introduced into Eq. 4.2-1 and 4.2-2 in the 1997 *Provisions*. This factor, determined in accordance with Sec. 4.3.3, relates to the redundancy inherent in the seismic-force-resisting system and is, in essence, a reliability factor, penalizing designs which are likely to be unreliable due to concentration of the structure's resistance to lateral forces in a relatively few elements.

There is very little research that speaks directly to the merits of redundancy in buildings for seismic resistance. The SAC joint venture recently studied the relationships between damage to welded steel moment frame connections and redundancy (Bonowitz et al., 1995). While this study found no specific correlation between damage and the number of bays of moment resisting framing per moment frame, it did find increased rates of damage in connections that resisted loads for larger floor areas. This study included modern low-, mid-, and high-rise steel buildings.

Another study (Wood, 1991) that addresses the potential effects of redundancy evaluated the performance of 165 Chilean concrete buildings ranging in height from 6 to 23 stories. These concrete shear wall

buildings with non-ductile details and no boundary elements experienced moderately strong shaking (MMI VII to VIII) with a strong shaking duration of over 60 seconds, yet performed well. One plausible explanation for this generally good performance was the substantial amount of wall area (2 to 4 percent of the floor area) commonly used in Chile. However, Wood's study found no correlation between damage rates and higher redundancy in buildings with wall areas greater than 2 percent.

4.2.2.2 Seismic load effect with overstrength. The seismic load effect with overstrength of Sec. 4.2.2.2 is intended to address those situations where failure of an isolated, individual, brittle element can result in the loss of a complete seismic-force-resisting system or in instability and collapse. This section has evolved over several editions. In the 1991 Edition, a factor equal to $2R/5$ factor was introduced to better represent the behavior of elements sensitive to overstrength in the remainder of the seismic-force-resisting system or in other specific structural components. The particular number was selected to correlate with the $3R_w/8$ factor that had been introduced in the Structural Engineers Association of California (SEAOC) recommendations and the *Uniform Building Code*. This is a somewhat arbitrary factor that attempts to quantify the maximum force that can be delivered to sensitive elements based on historic observation that the real force that could develop in a structure may be 3 to 4 times the design levels. In the 1997 *Provisions*, an attempt was made to determine this force more rationally through the assignment of the Ω_o factor in Table 4.3-1, dependent on the individual system. Through the use of the Ω_o coefficient, this special equation provides an estimate of the maximum forces likely to be experienced by an element.

In recent years, a number of researchers have investigated the factors that permit structures designed for reduced forces to survive design earthquakes. Although these studies have principally been focused on the development of more reliable response modification coefficients, R , they have identified the importance of structural overstrength and identified a number of sources of such overstrength. This has made it possible to replace the single $2R/5$ factor formerly contained in the *Provisions* with a more system-specific estimate, represented by the Ω_o coefficient.

It is recognized, that no single value, whether obtained by formula related to the R factor or otherwise obtained will provide a completely accurate estimate for the overstrength of all structures with a given seismic-force-resisting system. However, most structures designed with a given seismic-force-resisting system will fall within a range of overstrength values. Since the purpose of the Ω_o factor in Eq. 4.2-3 and 4.2-4 is to estimate the maximum force that can be delivered to a component that is sensitive to overstress, the values of this factor tabulated in Table 4.3-1 are intended to be representative of the larger values in this range for each system.

Figure C4.2-3 and the following discussion explore some of the factors that contribute to structural overstrength. The figure shows a plot of lateral structural strength vs. displacement for an elastic-perfectly-plastic structure. In addition, it shows a similar plot for a more representative real structure, that possesses significantly more strength than the design strength. This real strength is represented by the lateral force F_n . Essentially, the Ω_o coefficient is intended to be a somewhat conservative estimate of the ratio of F_n to the design strength F_E/R . As shown in the figure, there are three basic components to the overstrength. These are the design overstrength (Ω_D), the material overstrength (Ω_M) and the system overstrength (Ω_S). Each of these is discussed separately. The design overstrength (Ω_D) is the most difficult of the three to estimate. It is the difference between the lateral base shear force at which the first significant yield of the structure will occur (point 1 in the figure) and the minimum specified force given by F_E/R . To some extent, this is system dependent. Systems that are strength controlled, such as most braced frames and shear wall structures, will typically have a relatively low value of design overstrength, as most designers will seek to optimize their designs and provide a strength that is close to the minimum specified by the *Provisions*. For such structures, this portion of the overstrength coefficient could be as low as 1.0.

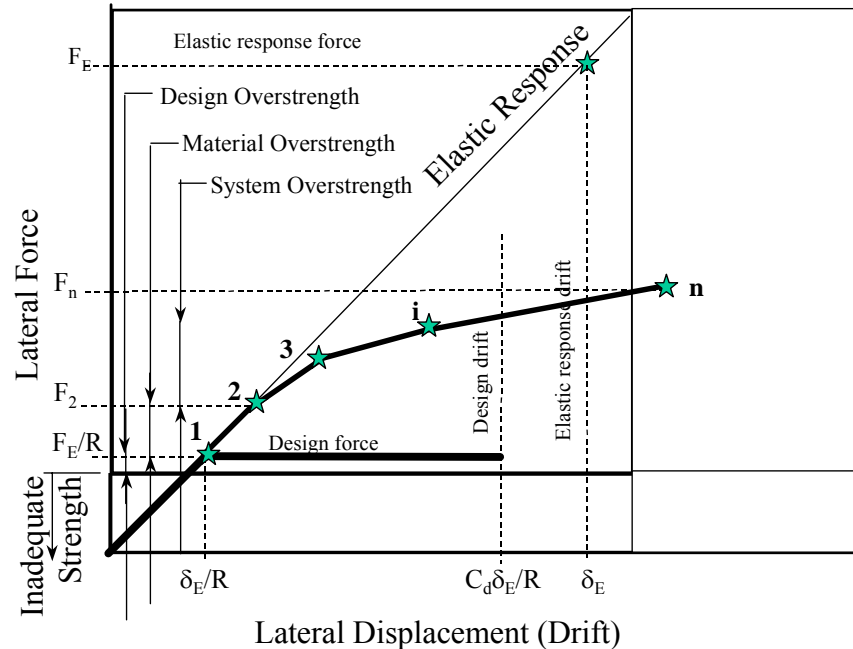

Figure C4.2-3 Factors affecting overstrength.

Drift controlled systems such as moment frames, however, will have substantially larger design overstrengths since it will be necessary to oversize the sections of such structures in order to keep the lateral drifts within prescribed limits. In a recent study of a number of special moment resisting steel frames conducted by the SAC Joint Venture design overstrengths on the order of a factor of two to three were found to exist (*Analytical Investigation of Buildings Affected by the 1994 Northridge Earthquake, Volumes 1 and 2*, SAC 95-04A and B. SAC Joint Venture, Sacramento, CA, 1995). Design overstrength also has the potential to be regionally dependent. The SAC study was conducted for frames in Seismic Design Categories D and E, which represent the most severe design conditions. For structures in Seismic Design Categories A, B and C, seismic force resistance would play a less significant role in the sizing of frame elements to control drifts, and consequently, design overstrengths for these systems would be somewhat lower. It seems reasonable to assume that this portion of the design overstrength for special moment frame structures is on the order of 2.0.

Architectural design considerations have the potential to play a significant role in design overstrength. Some architectural designs will incorporate many more and larger lateral-force-resisting elements than are required to meet the strength and drift limitations of the code. An example of this is warehouse type structures, wherein the massive perimeter walls of the structure can provide very large lateral strength. However, even in such structures, there is typically some limiting element, such as the diaphragm, that prevents the design overstrength from becoming uncontrollably large. Thus, although the warehouse structure may have very large lateral resistance in its shear walls, typically the roof diaphragm will have a lateral-force-resisting capacity comparable to that specified as a minimum by the *Provisions*.

Finally, the structural designer can affect the design overstrength. While some designers seek to optimize their structures with regard to the limitations contained in the *Provisions*, others will intentionally seek to provide greater strength and drift control than required. Typically design overstrength intentionally introduced by the designer will be on the order of 10 percent of the minimum required strength, but it may range as high as 50 to 100 percent in some cases. A factor of 1.2 should probably be presumed for this portion of the design overstrength to include the effects of both architectural and structural design

overstrength. Designers who intentionally provide greater design overstrength should keep in mind that the Ω_o factors used in their designs should be adjusted accordingly.

Material overstrength (Ω_M) results from the fact that the design values used to proportion the elements of a structure are specified by the *Provisions* to be conservative lower bound estimates of the actual probable strengths of the structural materials and their effective strengths in the as-constructed structure. It is represented in the figure by the ratio of F_2/F_1 , where F_2 and F_1 are respectively the lateral force at points 2 and 1 on the curve. All structural materials have considerable variation in the strengths that can be obtained in given samples of the material from a specific grade. The design requirements typically base proportioning requirements on minimum specified values that are further reduced through strength reduction (ϕ) factors. The actual expected strength of the as-constructed structure is significantly higher than this design value and should be calculated using the mean strength of the material, based on statistical data, by removal of the ϕ factor from the design equation, and by providing an allowance for strain hardening, where significant yielding is expected to occur. Code requirements for reinforced masonry, concrete and steel have historically used a factor of 1.25 to account for the ratio of mean to specified strength and the effects of some strain hardening. Considering a typical capacity reduction factor on the order of 0.9, this would indicate that the material overstrength for systems constructed of these materials would be on the order of $1.25/0.9$, or 1.4.

System overstrength (Ω_S) is the ratio of the ultimate lateral force the structure is capable of resisting, F_n in the figure, to the actual force at which first significant yield occurs, F_2 in the figure. It is dependent on the amount of redundancy contained in the structure as well as the extent to which the designer has optimized the various elements that participate in lateral force resistance. For structures, with a single lateral-force-resisting element, such as a braced frame structure with a single bay of bracing, the system overstrength (Ω_S) factor would be 1.0, because once the brace in the frame yields, the system becomes fully yielded. For structures that have a number of elements participating in lateral-force resistance, whether or not actually intended to do so, the system overstrength will be significantly larger than this, unless the designer has intentionally optimized the structure such that a complete side sway mechanism develops at the level of lateral drift at which the first actual yield occurs.

Structural optimization is most likely to occur in structures where the actual lateral-force resistance is dominated by the design of elements intended to participate as part of the lateral-force-resisting system, and where the design of those elements is dominated by seismic loads, as opposed to gravity loads. This would include concentrically braced frames and eccentrically braced frames in all Seismic Design Categories and Special Moment Frames in Seismic Design Categories D and E. For such structures, the system overstrength may be taken on the order of 1.1. For dual system structures, the system overstrength is set by the *Provisions* at an approximate minimum value of 1.25. For structures where the number of elements that actually resist lateral forces is based on other than seismic design considerations, the system overstrength may be somewhat larger. In light framed residential construction, for example, the number of walls is controlled by architectural rather than seismic design consideration. Such structures may have a system overstrength on the order of 1.5. Moment frames, the design of which is dominated by gravity load considerations can easily have a system overstrength of 2.0 or more. This effect is somewhat balanced by the fact that such frames will have a lower design overstrength related to the requirement to increase section sizes to obtain drift control. Table C4.2-1 presents some possible ranges of values for the various components of overstrength for various structural systems as well as the overall range of values that may occur for typical structures.

Table C4.2-1 Typical Range of Overstrength for Various Systems

Structural System	Design Overstrength Ω_D	Material Overstrength Ω_M	System Overstrength Ω_S	Ω_0
Special moment frames (steel, concrete)	1.5-2.5	1.2-1.6	1.0-1.5	2-3.5
Intermediate moment frames (steel, concrete)	1.0-2.0	1.2-1.6	1.0-2.0	2-3.5
Ordinary moment frames (steel, concrete)	1.0-1.5	1.2-1.6	1.5-2.5	2-3.5
Masonry wall frames	1.0-2.0	1.2-1.6	1.0-1.5	2-2.5
Braced frames	1.5-2.0	1.2-1.6	1.0-1.5	1.5-2
Reinforced bearing wall	1.0-1.5	1.2-1.6	1.0-1.5	1.5-2.5
Reinforced infill wall	1.0-1.5	1.2-1.6	1.0-1.5	1.5-2.5
Unreinforced bearing wall	1.0-2.0	0.8-2.0	1.0-2.0	2-3
Unreinforced infill wall	1.0-2.0	0.8-2.0	1.0-2.0	2-3
Dual system bracing and frame	1.1-1.75	1.2-1.6	1.0-1.5	1.5-2.5
Light bearing wall systems	1.0-0.5	1.2-2.0	1.0-2.0	2.5-3.5

In recognition of the fact that it is difficult to accurately estimate the amount of overstrength a structure will have, based solely on the type of seismic-force-resisting system that is present, in lieu of using the values of the overstrength coefficient Ω_0 provided in Table 4.3-1, designers are encouraged to base the maximum forces used in Eq. 4.3-3 and 4.3-4 on the results of suitable nonlinear analysis of the structure. Such analyses should use the actual expected (rather than specified) values of material and section properties. Appropriate forms of such analyses could include a plastic mechanism analysis, a static pushover analysis, or a nonlinear response history analysis. If a plastic mechanism analysis is utilized, the maximum seismic force that ever could be produced in the structure, regardless of the ground motion experienced, is estimated. If static pushover or nonlinear response history analyses are employed, the forces utilized for design as the maximum force should probably be those determined for Maximum Considered Earthquake level ground shaking demands.

While overstrength can be quite beneficial in permitting structures to resist actual seismic demands that are larger than those for which they have been specifically designed, it is not always beneficial. Some elements incorporated in structures behave in a brittle manner and can fail in an abrupt manner if substantially overloaded. The existence of structural overstrength results in a condition where such overloads are likely to occur, unless they are specifically accounted for in the design process. This is the purpose of Eq. 4.3-3 and 4.3-4.

One case where structural overstrength should specifically be considered is in the design of column elements beneath discontinuous braced frames and shear walls, such as occurs at vertical in-plane and out-of-plane irregularities. Overstrength in the braced frames and shear walls could cause buckling failure of such columns with resulting structural collapse. Columns subjected to tensile loading in which splices are made using partial penetration groove welds, a type of joint subject to brittle fracture when overloaded, are another example of a case where the seismic effect with overstrength should be used. Other design situations that warrant the use of these equations are noted throughout the *Provisions*.

Although the *Provisions* note the most common cases in which structural overstrength can lead to an undesirable failure mode, it is not possible for them to note all such conditions. Therefore, designers using the *Provisions* should be alert to conditions where the isolated independent failure of any element can lead to a condition of instability or collapse and should use the seismic effect with overstrength of Eq.

4.2-3 and 4.2-4 for the design of such elements. Other conditions which may warrant such a design approach, although not specifically noted in the *Provisions*, include the design of transfer structures beneath discontinuous lateral-force-resisting elements and the design of diaphragm force collectors to shear walls and braced frames, when these are the only method of transferring force to these elements at a diaphragm level.

4.3 SEISMIC-FORCE-RESISTING SYSTEM

4.3.1 Selection and limitations. For purposes of these seismic analyses and design requirements, building framing systems are grouped in the structural system categories shown in Table 4.3-1. These categories are similar to those contained for many years in the requirements of the *Uniform Building Code*; however, a further breakdown is included for the various types of vertical components in the seismic-force-resisting system. In selecting a structural system, the designer is cautioned to consider carefully the interrelationship between continuity, toughness (including minimizing brittle behavior), and redundancy in the structural framing system as is subsequently discussed in this commentary.

Specification of R factors requires considerable judgment based on knowledge of actual earthquake performance as well as research studies; yet, they have a major effect on building costs. The factors in Table 4.3-1 continue to be reviewed in light of recent research results. In the selection of the R values for the various systems, consideration has been given to the general observed performance of each of the system types during past earthquakes, the general toughness (ability to dissipate energy without serious degradation) of the system, and the general amount of damping present in the system when undergoing inelastic response. The designer is cautioned to be especially careful in detailing the more brittle types of systems (low C_d values).

A bearing wall system refers to that structural support system wherein major load-carrying columns are omitted and the walls and/or partitions are of sufficient strength to carry the gravity loads for some portion of the building (including live loads, floors, roofs, and the weight of the walls themselves). The walls and partitions supply, in plane, lateral stiffness and stability to resist wind and earthquake loadings as well as any other lateral loads. In some cases, vertical trusses are employed to augment lateral stiffness. In general, this system has comparably lower values of R than the other systems due to the frequent lack of redundancy for the vertical and horizontal load support. The category designated "light frame walls with shear panels" is intended to cover wood or steel stud wall systems with finishes other than masonry veneers.

A building frame system is a system in which the gravity loads are carried primarily by a frame supported on columns rather than by bearing walls. Some minor portions of the gravity load may be carried on bearing walls but the amount so carried should not represent more than a few percent of the building area. Lateral resistance is provided by nonbearing structural walls or braced frames. The light frame walls with shear panels are intended only for use with wood and steel building frames. Although there is no requirement to provide lateral resistance in this framing system, it is strongly recommended that some moment resistance be incorporated at the joints. In a structural steel frame, this could be in the form of top and bottom clip angles or tees at the beam- or girder-to-column connections. In reinforced concrete, continuity and full anchorage of longitudinal steel and stirrups over the length of beams and girders framing into columns would be a good design practice. With this type of interconnection, the frame becomes capable of providing a nominal secondary line of resistance even though the components of the seismic-force-resisting system are designed to carry all of the seismic force.

A moment resisting space frame system is a system having an essentially complete space frame as in the building frame system. However, in this system, the primary lateral resistance is provided by moment resisting frames composed of columns with interacting beams or girders. Moment resisting frames may be either ordinary, intermediate, or special moment frames as indicated in Table 4.3-1 and limited by the Seismic Design Categories.

Special moment frames must meet all the design and detailing requirements of Chapter 8, 9, 10, or 11. The ductility requirements for these frame systems are appropriate for all structures anticipated to experience large inelastic demands. For this reason, they are required in zones of high seismicity with

large anticipated ground shaking accelerations. In zones of lower seismicity, the inherent overstrength in typical structural designs is such that the anticipated inelastic demands are somewhat reduced, and less ductile systems may be safely employed. For buildings in which these special design and detailing requirements are not used, lower R values are specified indicating that ordinary framing systems do not possess as much toughness and that less reduction from the elastic response can be tolerated.

Requirements for composite steel-concrete systems were first introduced in the 1994 Edition. The R , Ω_o , and C_d values for the composite systems in Table 4.3-1 are similar to those for comparable systems of structural steel and reinforced concrete. The values shown in Table 4.3-1 are only allowed when the design and detailing requirements for composite structures in Chapter 10 are followed.

Inverted pendulum structures are singled out for special consideration because of their unique characteristics. These structures have little redundancy and overstrength and concentrate inelastic behavior at their bases. As a result, they have substantially less energy dissipation capacity than other systems. A number of buildings incorporating this system experienced very severe damage, and in some cases, collapse, in the 1994 Northridge earthquake.

4.3.1.1 Dual system. A dual system consists of a three-dimensional space frame made up of columns and beams that provide primary support for the gravity loads. Primary lateral resistance is supplied by structural nonbearing walls or bracing; the frame is provided with a redundant lateral-force-resisting system that is a moment frame complying with the requirements of Chapters 8, 9, 10, or 11. The moment frame is required to be capable of resisting at least 25 percent of the specified seismic force; this percentage is based on the judgment of the writers. Normally the moment frame would be a part of the basic space frame. The walls or bracing acting together with the moment frame must be capable of resisting all of the design seismic force. The following analyses are required for dual systems:

1. The frame and shear walls or braced frames must resist the prescribed lateral seismic force in accordance with their relative rigidities considering fully the interaction of the walls or braced frames and the moment frames as a single system. This analysis must be made in accordance with the principles of structural mechanics considering the relative rigidities of the elements and torsion in the system. Deformations imposed upon members of the moment frame by their interaction with the shear walls or braced frames must be considered in this analysis.
2. The moment frame must be designed to have a capacity to resist at least 25 percent of the total required lateral seismic force including torsional effects.

4.3.1.2 Combinations of framing systems. For those cases where combinations of structural systems are employed, the designer must use judgment in selecting appropriate R , Ω_o , and C_d values. The intent of Sec. 4.3.1.2.1 is to prohibit support of one system by another possessing characteristics that result in a lower base shear factor. The entire system should be designed for the higher seismic shear as the provision stipulates. The exception is included to permit the use of such systems as a braced frame penthouse on a moment frame building in which the mass of the penthouse does not represent a significant portion of the total building and, thus, would not materially affect the overall response to earthquake motions.

Sec. 4.3.1.2.2 pertains to details and is included to help ensure that the more ductile details inherent with the design for the higher R value system will be employed throughout. The intent is that details common to both systems be designed to remain functional throughout the response in order to preserve the integrity of the seismic-force-resisting system.

4.3.1.3 - 4.3.1.6 Seismic Design Categories. General framing system requirements for the building Seismic Design Categories are given in these sections. The corresponding design and detailing requirements are given in Sec. 4.6 and Chapters 8 through 14. There are no restrictions on the selection of structural systems in Seismic Design Category A. Table 4.3-1 indicates the systems permitted in all other Seismic Design Categories.

4.3.1.4 Seismic Design Category D. Sec. 4.3.1.4 covers Seismic Design Category D, which compares roughly to California design practice for normal buildings away from major faults. In keeping with the philosophy of present codes for zones of high seismic risk, these requirements continue limitations on the use of certain types of structures over 160 ft (49 m) in height but with some changes. Although it is agreed that the lack of reliable data on the behavior of high-rise buildings whose structural systems involve shear walls and/or braced frames makes it convenient at present to establish some limits, the values of 160 ft (49 m) and 240 ft (73 m) introduced in these requirements are arbitrary. Considerable disagreement exists regarding the adequacy of these values, and it is intended that these limitations be the subject of further study.

According to these requirements require that buildings in Category D over 160 ft (49 m) in height must have one of the following seismic-force-resisting systems:

1. A moment resisting frame system with special moment frames capable of resisting the total prescribed seismic force. This requirement is the same as present SEAOC and *UBC* recommendations.
2. A dual system as defined in this chapter, wherein the prescribed forces are resisted by the entire system and the special moment frame is designed to resist at least 25 percent of the prescribed seismic force. This requirement is also similar to SEAOC and *UBC* recommendations. The purpose of the 25 percent frame is to provide a secondary defense system with higher degrees of redundancy and ductility in order to improve the ability of the building to support the service loads (or at least the effect of gravity loads) after strong earthquake shaking. It should be noted that SEAOC and *UBC* requirements prior to 1987 required that shear walls or braced frames be able to resist the total required seismic lateral forces independently of the special moment frame. The *Provisions* require only that the true interaction behavior of the frame-shear wall (or braced frame) system be considered. If the analysis of the interacting behavior is based only on the vertical distribution of seismic lateral forces determined using the equivalent lateral force procedure of Sec. 5.2, the interpretation of the results of this analysis for designing the shear walls or braced frame should recognize the effects of higher modes of vibration. The internal forces that can be developed in the shear walls in the upper stories can be more severe than those obtained from the ELF procedure.
3. The use of a shear wall (or braced frame) system of cast-in-place concrete or structural steel up to a height of 240 ft (73 m) is permitted only if braced frames or shear walls in any plane do not resist more than 60 percent of the seismic design force including torsional effects and the configuration of the lateral-force-resisting system is such that torsional effects result in less than a 20 percent contribution to the strength demand on the walls or frames. The intent is that each of these shear walls or braced frames be in a different plane and that the four or more planes required be spaced adequately throughout the plan or on the perimeter of the building in such a way that the premature failure of one of the single walls or frames will not lead to excessive inelastic torsion.

Although a structural system with lateral force resistance concentrated in the interior core (Figure C4.3-1) is acceptable according to the *Provisions*, it is highly recommended that use of such a system be avoided, particularly for taller buildings. The intent is to replace it by the system with lateral force resistance distributed across the entire building (Figure C4.3-2). The latter system is believed to be more suitable in view of the lack of reliable data regarding the behavior of tall buildings having structural systems based on central cores formed by coupled shear walls or slender braced frames.

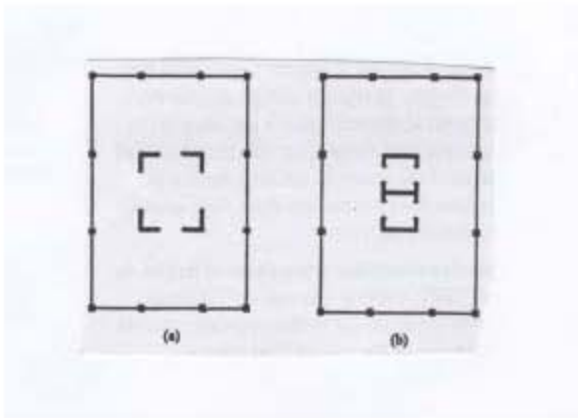

Figure C4.3-1 Arrangement of shear walls and braced frames – not recommended. Note that the heavy lines indicate shear walls and/or braced frames.

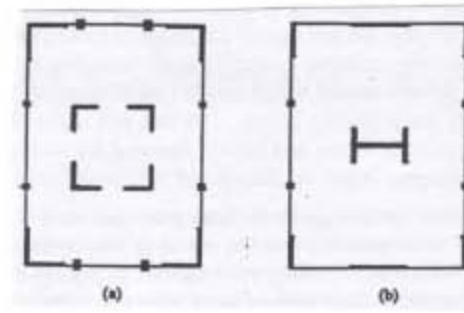

Figure C4.3-2 Arrangement of shear walls and braced frames – recommended. Note that the heavy lines indicate shear walls and/or braced frames.

4.3.1.4.2 Interaction effects. This section relates to the interaction of elements of the seismic-force-resisting system with elements that are not part of this system. A classic example of such interaction is the behavior of infill masonry walls used as architectural elements in a building provided with a seismic-force-resisting system composed of moment resisting frames. Although the masonry walls are not intended to resist seismic forces, at low levels of deformation they will be substantially more rigid than the moment resisting frames and will participate in lateral force resistance. A common effect of such walls is that they can create shear-critical conditions in the columns they abut by reducing the effective flexural height of these columns to the height of the openings in the walls. If these walls are neither uniformly distributed throughout the structure nor effectively isolated from participation in lateral force resistance, they can also create torsional irregularities and soft story irregularities in structures that would otherwise have regular configuration.

Infill walls are not the only elements not included in seismic-force-resisting systems that can affect a structure's seismic behavior. For example, in parking garage structures, the ramps between levels can act as effective bracing elements and resist a large portion of the seismically induced forces. They can induce large thrusts in the diaphragms where they connect, as well as large vertical forces on the adjacent columns and beams. In addition, if not symmetrically placed in the structure they can induce torsional irregularities. This section requires consideration of these potential effects.

4.3.1.6 Seismic Design Category F. Sec. 4.3.1.6 covers Category F, which is restricted to essential facilities on sites located within a few kilometers of major active faults. Because of the necessity for reducing risk (particularly in terms of providing life safety or maintaining function by minimizing damage to nonstructural building elements, contents, equipment, and utilities), the height limitations for Category F are reduced. Again, the limits—100 ft (30 m) and 160 ft (49 m)—are arbitrary and require further study. The developers of these requirements believe that, at present, it is advisable to establish these limits, but the importance of having more stringent requirements for detailing the seismic-force-resisting system as well as the nonstructural components of the building must be stressed. Such requirements are specified in Sec. 4.6 and Chapters 8 through 12.

4.3.2 Configuration. The configuration of a structure can significantly affect its performance during a strong earthquake that produces the ground motion contemplated in the *Provisions*. Configuration can be divided into two aspects: plan configuration and vertical configuration. The *Provisions* were basically derived for buildings having regular configurations. Past earthquakes have repeatedly shown that buildings having irregular configurations suffer greater damage than buildings having regular configurations. This situation prevails even with good design and construction. There are several reasons

for this poor behavior of irregular structures. In a regular structure, inelastic demands produced by strong ground shaking tend to be well distributed throughout the structure, resulting in a dispersion of energy dissipation and damage. However, in irregular structures, inelastic behavior can concentrate in the zone of irregularity, resulting in rapid failure of structural elements in these areas. In addition, some irregularities introduce unanticipated stresses into the structure which designers frequently overlook when detailing the structural system. Finally, the elastic analysis methods typically employed in the design of structures often cannot predict the distribution of earthquake demands in an irregular structure very well, leading to inadequate design in the zones of irregularity. For these reasons, these requirements are designed to encourage that buildings be designed to have regular configurations and to prohibit gross irregularity in buildings located on sites close to major active faults, where very strong ground motion and extreme inelastic demands can be experienced.

4.3.2.2 Plan irregularity. Sec. 4.3.2.2 indicates, by reference to Table 4.3-2, under what circumstances a building must be designated as having a plan irregularity for the purposes of the *Provisions*. A building may have a symmetrical geometric shape without re-entrant corners or wings but still be classified as irregular in plan because of distribution of mass or vertical, seismic-force-resisting elements. Torsional effects in earthquakes can occur even when the static centers of mass and resistance coincide. For example, ground motion waves acting with a skew with respect to the building axis can cause torsion. Cracking or yielding in a nonsymmetrical fashion also can cause torsion. These effects also can magnify the torsion due to eccentricity between the static centers. For this reason, buildings having an eccentricity between the static center of mass and the static center of resistance in excess of 10 percent of the building dimension perpendicular to the direction of the seismic force should be classified as irregular. The vertical resisting components may be arranged so that the static centers of mass and resistance are within the limitations given above and still be unsymmetrically arranged so that the prescribed torsional forces would be unequally distributed to the various components. In the 1997 *Provisions*, torsional irregularities were subdivided into two categories, with a category of extreme irregularity having been created. Extreme torsional irregularities are prohibited for structures located very close to major active faults and should be avoided, when possible, in all structures.

There is a second type of distribution of vertical, resisting components that, while not being classified as irregular, does not perform well in strong earthquakes. This arrangement is termed a core-type building with the vertical components of the seismic-force-resisting system concentrated near the center of the building. Better performance has been observed when the vertical components are distributed near the perimeter of the building. In recognition of the problems leading to torsional instability, a torsional amplification factor is introduced in Sec. 5.2.4.3.

A building having a regular configuration can be square, rectangular, or circular. A square or rectangular building with minor re-entrant corners would still be considered regular but large re-entrant corners creating a crucifix form would be classified as an irregular configuration. The response of the wings of this type of building is generally different from the response of the building as a whole, and this produces higher local forces than would be determined by application of the *Provisions* without modification. Other plan configurations such as H-shapes that have a geometrical symmetry also would be classified as irregular because of the response of the wings.

Significant differences in stiffness between portions of a diaphragm at a level are classified as irregularities since they may cause a change in the distribution of seismic forces to the vertical components and create torsional forces not accounted for in the normal distribution considered for a regular building. Examples of plan irregularities are illustrated in Figure C4.3-3.

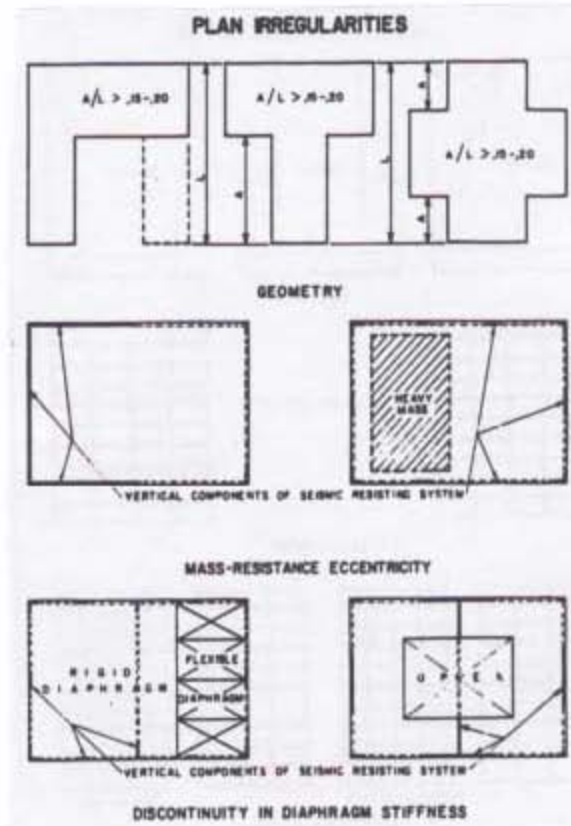

Figure 4.3-3 Building plan irregularities

Where there are discontinuities in the path of lateral force resistance, the structure can no longer be considered to be “regular.” The most critical of the discontinuities to be considered is the out-of-plane offset of vertical elements of the seismic-force-resisting elements. Such offsets impose vertical and lateral load effects on horizontal elements that are, at the least, difficult to provide for adequately.

Where vertical elements of the lateral-force-resisting system are not parallel to or symmetric about major orthogonal axes, the static lateral force procedures of the *Provisions* cannot be applied as given and, thus, the structure must be considered to be “irregular.”

4.3.2.3 Vertical irregularity. Sec. 4.3.2.3 indicates, by reference to Table 4.3-3, under what circumstances a structure must be considered to have a vertical irregularity. Vertical configuration irregularities affect the responses at the various levels and induce loads at these levels that are significantly different from the distribution assumed in the equivalent lateral force procedure given in Sec. 5.2.

A moment resisting frame building might be classified as having a vertical irregularity if one story were much taller than the adjoining stories and the design did not compensate for the resulting decrease in stiffness that would normally occur. Examples of vertical irregularities are illustrated in Figure C4.3-4.

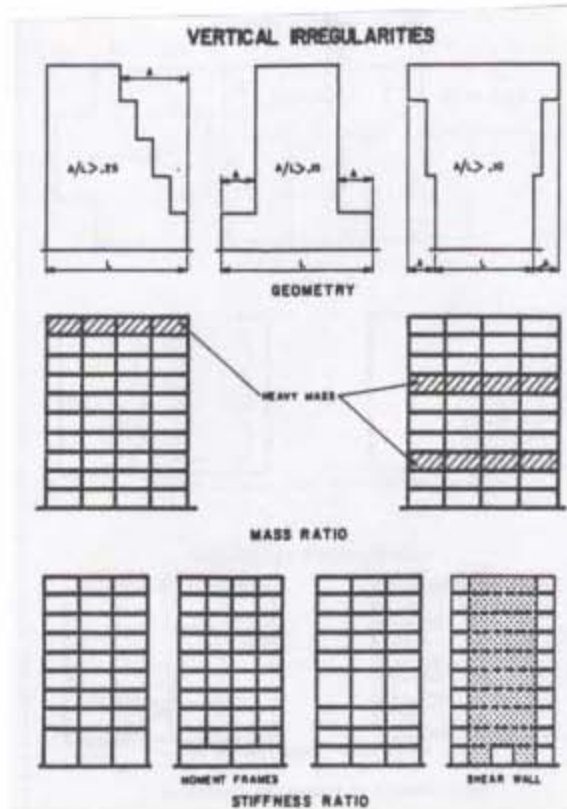

Figure C4.34 Building elevation irregularities

A building would be classified as irregular if the ratio of mass to stiffness in adjoining stories differs significantly. This might occur when a heavy mass, such as a swimming pool, is placed at one level. Note that the exception in the *Provisions* provides a comparative stiffness ratio between stories to exempt structures from being designated as having a vertical irregularity of the types specified.

One type of vertical irregularity is created by unsymmetrical geometry with respect to the vertical axis of the building. The building may have a geometry that is symmetrical about the vertical axis and still be classified as irregular because of significant horizontal offsets in the vertical elements of the lateral-force-resisting system at one or more levels. An offset is considered to be significant if the ratio of the larger dimension to the smaller dimension is more than 130 percent. The building also would be considered irregular if the smaller dimension were below the larger dimension, thereby creating an inverted pyramid effect.

Weak story irregularities occur whenever the strength of a story to resist lateral demands is significantly less than that of the story above. This is because buildings with this configuration tend to develop all of their inelastic behavior at the weak story. This can result in a significant change in the deformation pattern of the building, with most earthquake induced displacement occurring within the weak story. This can result in extensive damage within the weak story and even instability and collapse. Note that an exception has been provided in Sec. 4.6.1.6 where there is considerable overstrength of the “weak” story.

In the 1997 *Provisions*, the soft story irregularity was subdivided into two categories with an extreme soft story category being created. Like weak stories, soft stories can lead to instability and collapse. Buildings with extreme soft stories are now prohibited on sites located very close to major active faults.

4.3.3 Redundancy. The 1997 *Provisions* introduced specific requirements intended to quantify the importance of redundancy. Many parts of the *Provisions*, particularly the response modification

coefficients, R , were originally developed assuming that structures possess varying levels of redundancy that heretofore were undefined. *Commentary* Sec. 4.2.1 recommends that lower R values be used for non-redundant systems, but does not provide guidance on how to select and justify appropriate reductions. As a result, many non-redundant structures have been designed in the past using values of R that were intended for use in designing structures with higher levels of redundancy. For example, current R values for special moment resisting frames were initially established in the 1970s based on the then widespread use of complete or nearly complete frame systems in which all beam-column connections were designed to participate in the lateral-force-resisting system. High R values were justified by the large number of potential hinges that could form in such redundant systems, and the beneficial effects of progressive yield hinge formation described in Sec. C4.2.1. However, in recent years, economic pressures have encouraged the now prevalent use of much less redundant special moment frames with relatively few bays of moment resisting framing supporting large floor and roof areas. Similar observations have been made of other types of construction as well. Modern concrete and masonry shear wall buildings, for example, have many fewer walls than were once commonly provided in such buildings.

In order to quantify the effects of redundancy, the 1997 *Provisions* introduced the concept of a redundancy factor, ρ , that is applied to the design earthquake loads in the seismic load effect equations of Sec. 4.2.2.1, for structures in Seismic Design Categories D, E, and F. The value of the reliability factor ρ varies from 1 to 1.5. In effect this reduces the R values for less redundant structures and should provide greater economic incentive for the design of structures with well distributed lateral-force-resisting systems. The formulation for the equation from which ρ is derived is similar to that developed by SEAOC for inclusion in the 1997 edition of the *Uniform Building Code*. It bases the value of ρ on the floor area of the building and the parameter “ r ” which relates to the amount of the building’s design lateral force carried by any single element.

There are many other considerations than just floor area and element/story shear ratios that should be considered in quantifying redundancy. Conceptually, element demand/capacity ratios, types of mechanisms which may form, individual characteristics of building systems and materials, building height, number of stories, irregularity, torsional resistance, chord and collector length, diaphragm spans, number of lines of resistance, and number of elements per line are all important and will intrinsically influence the level of redundancy in systems and their reliability.

The SEAOC proposed code change to the 1997 *UBC* recommends addressing redundancy in irregular buildings by evaluating the ratio of element shear to design story shear, “ r ” only in the lower two-thirds of the height. However, in response to failures of buildings that have occurred at and above mid-heights, the writers of the *Provisions* chose to base the ρ factor on the worst “ r ” for the least redundant story. The resulting factor is then applied throughout the height of the building.

The Applied Technology Council, in its ATC 19 report suggests that future redundancy factors be based on reliability theory. For example, if the number of hinges in a moment frame required to achieve a minimally redundant system were established, a redundancy factor for less redundant systems could be based on the relationship of the number of hinges actually provided to those required for minimally redundant systems. ATC suggests that similar relationships could be developed for shear wall systems using reliability theory. However, much work yet remains to be completed before such approaches will be ready for adoption into the *Provisions*.

The *Provisions* limit special moment resisting frames to configurations that provide maximum ρ values of 1.25 and 1.1, respectively, in Seismic Design Categories D, and E or F, to compensate for the strength based factor in what are typically drift-controlled systems. Other seismic-force-resisting systems that are not typically drift controlled may be proportioned to exceed the maximum ρ factor of 1.5; however, it is not recommended that this be done.

4.4 STRUCTURAL ANALYSIS

4.4.1 Procedure selection. Many of the standard procedures for the analysis of forces and deformations in structures subjected to earthquake ground motion are listed below in order of increasing rigor and expected accuracy:

1. Equivalent lateral force procedure (Sec. 5.2).
2. Response spectrum (modal analysis) procedure (Sec. 5.3).
3. Linear response history procedure (Sec. 5.4).
4. Nonlinear static procedure, involving incremental application of a pattern of lateral forces and adjustment of the structural model to account for progressive yielding under load application (push-over analysis) (Appendix to Chapter 5).
5. Nonlinear response history procedure involving step-by-step integration of the coupled equations of motion (Sec. 5.5).

Each procedure becomes more rigorous if effects of soil-structure interaction are considered, either as presented in Sec. 5.6 or through a more complete analysis of this interaction, as appropriate. Every procedure improves in rigor if combined with use of results from experimental research (not described in these *Provisions*).

4.4.2 Application of loading. Earthquake forces act in both principal directions of the building simultaneously, but the earthquake effects in the two principal directions are unlikely to reach their maxima simultaneously. This section provides a reasonable and adequate method for combining them. It requires that structural elements be designed for 100 percent of the effects of seismic forces in one principal direction combined with 30 percent of the effects of seismic forces in the orthogonal direction.

The following combinations of effects of gravity loads, effects of seismic forces in the x-direction, and effects of seismic forces in the y-direction (orthogonal to x-direction) thus pertain:

$$\begin{aligned} &\text{gravity} \pm 100\% \text{ of x-direction} \pm 30\% \text{ of y-direction} \\ &\text{gravity} \pm 30\% \text{ of x-direction} \pm 100\% \text{ of y-direction} \end{aligned}$$

The combination and signs (plus or minus) requiring the greater member strength are used for each member. Orthogonal effects are slight on beams, girders, slabs, and other horizontal elements that are essentially one-directional in their behavior, but they may be significant in columns or other vertical members that participate in resisting earthquake forces in both principal directions of the building. For two-way slabs, orthogonal effects at slab-to-column connections can be neglected provided the moment transferred in the minor direction does not exceed 30 percent of that transferred in the orthogonal direction and there is adequate reinforcement within lines one and one-half times the slab thickness either side of the column to transfer all the minor direction moment.

4.5 DEFORMATION REQUIREMENTS

4.5.1 Deflection and drift limits. This section provides procedures for the limitation of story drift. The term “drift” has two connotations:

1. “Story drift” is the maximum lateral displacement within a story (i.e., the displacement of one floor relative to the floor below caused by the effects of seismic loads).
2. The lateral displacement or deflection due to design forces is the absolute displacement of any point in the structure relative to the base. This is not “story drift” and is not to be used for drift control or stability considerations since it may give a false impression of the effects in critical stories. However, it is important when considering seismic separation requirements.

There are many reasons for controlling drift; one is to control member inelastic strain. Although use of drift limitations is an imprecise and highly variable way of controlling strain, this is balanced by the current state of knowledge of what the strain limitations should be.

Stability considerations dictate that flexibility be controlled. The stability of members under elastic and inelastic deformation caused by earthquakes is a direct function of both axial loading and bending of members. A stability problem is resolved by limiting the drift on the vertical-load-carrying elements and the resulting secondary moment from this axial load and deflection (frequently called the P -delta effect). Under small lateral deformations, secondary stresses are normally within tolerable limits. However, larger deformations with heavy vertical loads can lead to significant secondary moments from the P -delta effects in the design. The drift limits indirectly provide upper bounds for these effects.

Buildings subjected to earthquakes need drift control to restrict damage to partitions, shaft and stair enclosures, glass, and other fragile nonstructural elements and, more importantly, to minimize differential movement demands on the seismic safety elements. Since general damage control for economic reasons is not a goal of this document and since the state of the art is not well developed in this area, the drift limits have been established without regard to considerations such as present worth of future repairs versus additional structural costs to limit drift. These are matters for building owners and designers to examine. To the extent that life might be excessively threatened, general damage to nonstructural and seismic-safety elements is a drift limit consideration.

The design story drift limits of Table 4.5-1 reflect consensus judgment taking into account the goals of drift control outlined above. In terms of life safety and damage control objectives, the drift limits should yield a substantial, though not absolute, measure of safety for well detailed and constructed brittle elements and provide tolerable limits wherein the seismic safety elements can successfully perform, provided they are designed and constructed in accordance with these *Provisions*.

To provide a higher performance standard, the drift limit for the essential facilities of Seismic Use Group III is more stringent than the limit for Groups I and II except for masonry shear wall buildings.

The drift limits for low-rise structures are relaxed somewhat provided the interior walls, partitions, ceilings, and exterior wall systems have been designed to accommodate story drifts. The type of steel building envisioned by the exception to the table would be similar to a prefabricated steel structure with metal skin. When the more liberal drift limits are used, it is recommended that special requirements be provided for the seismic safety elements to accommodate the drift.

It should be emphasized that the drift limits, Δ_a , of Table 4.5-1 are story drifts and, therefore, are applicable to each story (that is, they must not be exceeded in any story even though the drift in other stories may be well below the limit). The limit, Δ_a is to be compared to the design story drift as determined by Sec. 5.2.6.1.

Stress or strength limitations imposed by design level forces occasionally may provide adequate drift control. However, it is expected that the design of moment resisting frames, especially steel building frames, and the design of tall, narrow shear wall or braced frame buildings will be governed at least in part by drift considerations. In areas having large design spectral response accelerations, S_{DS} and S_{DI} , it is expected that seismic drift considerations will predominate for buildings of medium height. In areas having a low design spectral response accelerations and for very tall buildings in areas with large design spectral response accelerations, wind considerations generally will control, at least in the lower stories.

Due to probable first mode drift contributions, the Sec. 5.2 ELF procedure may be too conservative for drift design of very tall moment-frame buildings. It is suggested for these buildings, where the first mode would be responding in the constant displacement region of a response spectra (where displacements would be essentially independent of stiffness), that the response spectrum procedure of Sec. 5.3 be used for design even when not required by Sec. 4.4.1.

Building separations and seismic joints are separations between two adjoining buildings or parts of the same building, with or without frangible closures, for the purpose of permitting the adjoining buildings or parts to respond independently to earthquake ground motion. Unless all portions of the structure have been designed and constructed to act as a unit, they must be separated by seismic joints. For irregular structures that cannot be expected to act reliably as a unit, seismic joints should be utilized to separate the building into units whose independent response to earthquake ground motion can be predicted.

Although the *Provisions* do not give precise formulations for the separations, it is required that the distance be “sufficient to avoid damaging contact under total deflection” in order to avoid interference and possible destructive hammering between buildings. It is recommended that the distance be equal to the total of the lateral deflections of the two units assumed deflecting toward each other (this involves increasing separations with height). If the effects of hammering can be shown not to be detrimental, these distances can be reduced. For very rigid shear wall structures with rigid diaphragms whose lateral deflections cannot be reasonably estimated, it is suggested that older code requirements for structural separations of at least 1 in. (25 mm) plus 1/2 in. (13 mm) for each 10 ft (3 m) of height above 20 ft (6 m) be followed.

4.5.3 Seismic Design Categories D, E, and F. The purpose of this section is to require that the seismic-force-resisting system provide adequate deformation control to protect elements of the structure that are not part of the seismic-force-resisting system. In regions of high seismicity, it is relatively common to apply ductile detailing requirements to elements which are intended to resist seismic forces but to neglect such practices in nonstructural elements or elements intended to resist only gravity forces. The fact that many elements of the structure are not intended to resist seismic forces and are not detailed for such resistance does not prevent them from actually providing this resistance and becoming severely damaged as a result.

The 1994 Northridge earthquake provided several examples where this was a cause of failure. In a preliminary reconnaissance report of that earthquake (EERI, 1994) it was stated: “Of much significance is the observation that six of the seven partial collapses (in modern precast concrete parking structures) seem to have been precipitated by damage to the gravity load system. Possibly, the combination of large lateral deformation and vertical load caused crushing in poorly confined columns that were not detailed to be part of the lateral load resisting system.” The report also noted that: “Punching shear failures were observed in some structures at slab-to-column connections such as at the Four Seasons building in Sherman Oaks. The primary lateral load resisting system was a perimeter ductile frame that performed quite well. However, the interior slab-column system was incapable of undergoing the same lateral deflections and experienced punching failures.”

In response to a preponderance of evidence, SEAOC successfully submitted a change to the *Uniform Building Code* in 1994 to clarify and strengthen the existing requirements intended to require deformation compatibility. The statement in support of that code change included the following reasons:

“Deformation compatibility requirements have largely been ignored by the design community. In the 1994 Northridge earthquake, deformation-induced damage to elements which were not part of the lateral-force-resisting system resulted in structural collapse. Damage to elements of the lateral-framing system, whose behavior was affected by adjoining rigid elements, was also observed. This has demonstrated a need for stronger and clearer requirements. The proposed changes attempt to emphasize the need for specific design and detailing of elements not part of the lateral system to accommodate expected seismic deformation. . . .”

Language introduced in the 1997 *Provisions* was largely based on SEAOC’s successful 1995 change to the *Uniform Building Code*. Rather than implicitly relying on designers to assume appropriate levels of stiffness, the language in Sec. 4.5.3 explicitly requires that the “stiffening effects of adjoining rigid structural and nonstructural elements shall be considered and a rational value of member and restraint stiffness shall be used” for the design of components that are not part of the lateral-force-resisting system. This was intended to keep designers from neglecting the potentially adverse stiffening effects that such components can have on structures. This section also includes a requirement to address shears that can be induced in structural components that are not part of the lateral-force-resisting system since sudden shear failures have been catastrophic in past earthquakes.

The exception in Sec. 4.5.3 is intended to encourage the use of intermediate or special detailing in beams and columns that are not part of the lateral-force-resisting system. In return for better detailing, such beams and columns are permitted to be designed to resist moments and shears from unamplified deflections. This reflects observations and experimental evidence that well-detailed components can

accommodate large drifts by responding inelastically without losing significant vertical load carrying capacity.

4.6 DESIGN AND DETAILING REQUIREMENTS

The design and detailing requirements for components of the seismic-force-resisting system are stated in this section. The requirements of this section are spelled out in considerable detail. The major reasons for this are presented below.

The provision of detailed design ground motions and requirements for analysis of the structure do not by themselves make a building earthquake resistant. Additional design requirements are necessary to provide a consistent degree of earthquake resistance in buildings. The more severe the expected seismic ground motions, the more stringent these additional design requirements should be. Not all of the necessary design requirements are expressed in codes, and although experienced seismic design engineers account for them, engineers lacking experience in the design and construction of earthquake-resistant structures often overlook them. Considerable uncertainties exist regarding:

1. The actual dynamic characteristics of future earthquake motions expected at a building site;
2. The soil-structure-foundation interaction;
3. The actual response of buildings when subjected to seismic motions at their foundations; and
4. The mechanical characteristics of the different structural materials, particularly when they undergo significant cyclic straining in the inelastic range that can lead to severe reversals of strains.

It should be noted that the overall inelastic response of a structure is very sensitive to the inelastic behavior of its critical regions, and this behavior is influenced, in turn, by the detailing of these regions.

Although it is possible to counteract the consequences of these uncertainties by increasing the level of design forces, it is considered more feasible to provide a building system with the largest energy dissipation consistent with the maximum tolerable deformations of nonstructural components and equipment. This energy dissipation capacity, which is usually denoted simplistically as “ductility,” is extremely sensitive to the detailing. Therefore, in order to achieve such a large energy dissipation capacity, it is essential that stringent design requirements be used for detailing the structural as well as the nonstructural components and their connections or separations. Furthermore, it is necessary to have good quality control of materials and competent inspection. The importance of these factors has been clearly demonstrated by the building damage observed after both moderate and severe earthquakes.

It should be kept in mind that a building’s response to seismic ground motion most often does not reflect the designer’s or analyst’s original conception or modeling of the structure on paper. What is reflected is the manner in which the building was constructed in the field. These requirements emphasize the importance of detailing and recognize that the detailing requirements should be related to the expected earthquake intensities and the importance of the building’s function and/or the density and type of occupancy. The greater the expected intensity of earthquake ground-shaking and the more important the building function or the greater the number of occupants in the building, the more stringent the design and detailing requirements should be. In defining these requirements, the *Provisions* uses the concept of Seismic Design Categories (Tables 1.4-1 and 1.4-2), which relate to the design ground motion severities, given by the spectral response acceleration coefficients S_{DS} and S_{DI} (Chapter 3) and the Seismic Use Group (Sec. 1.2).

4.6.1 Seismic Design Category B. Category B and Category C buildings will be constructed in the largest portion of the United States. Earthquake-resistant requirements are increased appreciably over Category A requirements, but they still are quite simple compared to present requirements in areas of high seismicity.

The Category B requirements specifically recognize the need to design diaphragms, provide collector bars, and provide reinforcing around openings. These requirements may seem elementary and obvious but, because they are not specifically covered in many codes, some engineers totally neglect them.

4.6.1.1 Connections. The analysis of a structure and the provision of a design ground motion alone do not make a structure earthquake resistant; additional design requirements are necessary to provide adequate earthquake resistance in structures. Experienced seismic designers normally fill these requirements, but because some were not formally specified, they often are overlooked by inexperienced engineers.

Probably the most important single attribute of an earthquake-resistant structure is that it is tied together to act as a unit. This attribute is important not only in earthquake-resistant design, but also is indispensable in resisting high winds, floods, explosion, progressive failure, and even such ordinary hazards as foundation settlement. This section requires that all parts of the building (or unit if there are separation joints) be so tied together that any part of the structure is tied to the rest to resist a force of $0.133S_{DS}$ (but not less than 0.05) times the weight of the smaller. In addition, beams must be tied to their supports or columns and columns to footings for a minimum of 5 percent of the dead and live load reaction.

Certain connections of buildings with plan irregularities must be designed for higher forces than calculated due to the simplifying assumptions used in the analysis by Sec. 5.2, 5.3, and 5.4 (see Sec. 4.6.3.2).

4.6.1.2 Anchorage of concrete or masonry walls. One of the major hazards from buildings during an earthquake is the pulling away of heavy masonry or concrete walls from floors or roofs. Although requirements for the anchorage to prevent this separation are common in highly seismic areas, they have been minimal or nonexistent in most other parts of the country. This section requires that anchorage be provided in any locality to the extent of $400S_{DS}$ pounds per linear foot (plf) or $5,840$ times S_{DS} (N/m). This requirement alone may not provide complete earthquake-resistant design, but observations of earthquake damage indicate that it can greatly increase the earthquake resistance of buildings and reduce hazards in those localities where earthquakes may occur but are rarely damaging.

4.6.1.3 Bearing walls. A minimum anchorage of bearing walls to diaphragms or other resisting elements is specified. To ensure that the walls and supporting framing system interact properly, it is required that the interconnection of dependent wall elements and connections to the framing system have sufficient ductility or rotational capacity, or strength, to stay as a unit. Large shrinkage or settlement cracks can significantly affect the desired interaction.

4.6.1.5 Inverted pendulum-type structures. Inverted pendulum-type structures have a large portion of their mass concentrated near the top and, thus, have essentially one degree of freedom in horizontal translation. Often the structures are T-shaped with a single column supporting a beam or slab at the top. For such a structure, the lateral motion is accompanied by rotation of the horizontal element of the "T" due to rotation at the top of the column, resulting in vertical accelerations acting in opposite directions on the overhangs of the structure. Dynamic response amplifies this rotation; hence, a bending moment would be induced at the top of the column even though the procedures of Sec. 5.2 would not so indicate. A simple provision to compensate for this is specified in this section. The bending moments due to the lateral force are first calculated for the base of the column according to the requirements of Sec. 5.2. One-half of the calculated bending moment at the base is applied at the top and the moments along the column are varied from 1.5 M at the base to 0.5 M at the top. The addition of one-half the moment calculated at the base in accordance with Sec. 5.2 is based on analyses of inverted pendulums covering a wide range of practical conditions.

4.6.1.8 Collector elements. Many buildings have shear walls or other bracing elements that are not uniformly spaced around the diaphragms. Such conditions require that collector or drag members be provided. A simple illustration is shown in Figure C4.6-1.

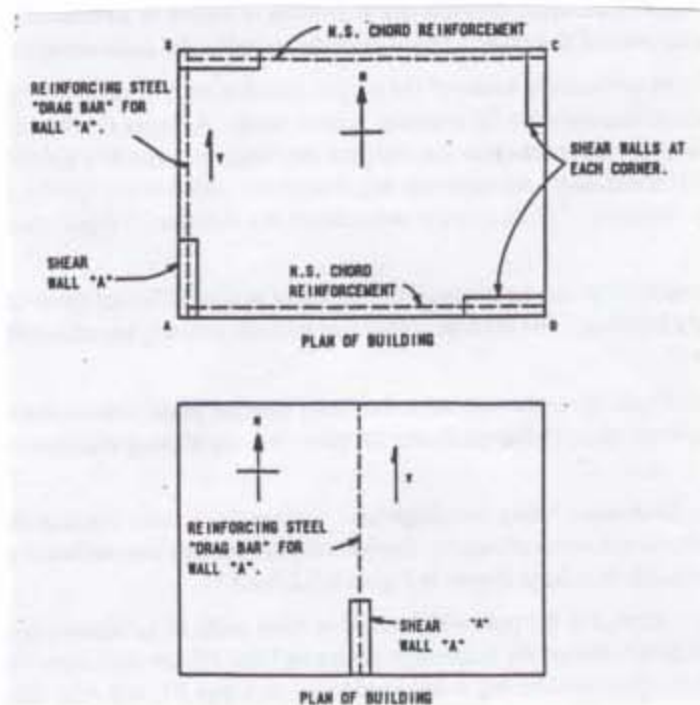

Figure 4.6-1 Collector element used to (a) transfer shears and (b) transfer drag forces from diaphragm to shear wall

Consider a building as shown in the plan with four short shear walls at the corners arranged as shown. For north-south earthquake forces, the diaphragm shears on Line AB are uniformly distributed between A and B if the chord reinforcing is assumed to act on Lines BC and AD. However, wall A is quite short so reinforcing steel is required to collect these shears and transfer them to the wall. If Wall A is a quarter of the length of AB, the steel must carry, as a minimum, three-fourths of the total shear on Line AB. The same principle is true for the other walls. In Figure C4.6-1 reinforcing is required to collect the shears or drag the forces from the diaphragm into the shear wall. Similar collector elements are needed for most shear walls and for some frames.

4.6.1.9 Diaphragms. Diaphragms are deep beams or trusses that distribute the lateral loads from their origin to the components where such forces are resisted. Therefore, diaphragms are subject to shears, bending moments, direct stresses (truss member, collector elements), and deformations. The deformations must be minimized in some cases because they could overstress the walls to which the diaphragms are connected. The amount of deflection permitted in the diaphragm must be related to the ability of the walls to deflect (normal to the direction of force application) without failure.

A detail commonly overlooked by many engineers is the requirement to tie the diaphragm together so that it acts as a unit. Wall anchorages tend to tear off the edges of the diaphragm; thus, the ties must be extended into the diaphragm so as to develop adequate anchorage. During the San Fernando earthquake, seismic forces from the walls caused separations in roof diaphragms 20 or more feet (6 m) from the edge in several industrial buildings.

Where openings occur in shear walls or diaphragms, temperature “trim bars” alone do not provide adequate reinforcement. The chord stresses must be provided for and the chords anchored to develop the chord stresses by embedment. The embedment must be sufficient to take the reactions without

overstressing the material in any respect. Since the design basis depends on an elastic analysis, the internal force system should be compatible with both static and the elastic deformations.

4.6.1.10 Anchorage of nonstructural systems. Anchorage of nonstructural systems and components of buildings is required as indicated in Chapter 6.

4.6.2 Seismic Design Category C. The material requirements in Chapters 8 through 12 for Category C are somewhat more restrictive than those for Categories A and B. Also, a nominal interconnection between pile caps and caissons is required.

4.6.3 Seismic Design Categories D, E and F. Category D requirements compare roughly to present design practice in California seismic areas for buildings other than schools and hospitals. All moment resisting frames of concrete or steel must meet ductility requirements. Interaction effects between structural and nonstructural elements must be investigated. Foundation interaction requirements are increased.

REFERENCES

Bonowitz, D., N. Youssef, and J. L. Gross. 1995. "A survey of steel moment-resisting frames buildings affected by the 1994 Northridge earthquake," Report no. *NISTIR 5625*, NIST, Gaithersburg, MD.

Earthquake Engineering Research Institute. 1994. *Preliminary Reconnaissance Report: Northridge Earthquake*.

SAC Joint Venture. 1995. *Analytical Investigation of Buildings Affected by the 1994 Northridge Earthquake*, Volumes 1 and 2, SAC 95-04A and B. SAC Joint Venture, Sacramento, CA.

Uang, C-M. 1991. "Establishing R (or R_w) and C_d Factors for Building Seismic Provisions," *Journal of Structural Engineering*, vol. 117, no. 1, pp. 19-28, ASCE.

Wood, S. L. 1991. "Performance of Reinforced Concrete Buildings During the 1985 Chile Earthquake," *EERI Spectra*, November.

Alternative Simplified Chapter 4 Commentary

In recent years, engineers and building officials have become concerned that the *Provisions*, and the building codes based on these *Provisions*, have become increasingly complex and difficult to understand and to implement. The basic driving force for this increasing complexity is the desire of the Provisions Update Committee to provide design guidelines that will provide for the reliable performance of structures. Since the response of buildings to earthquake ground shaking is by nature, very complex, realistic accounting for these effects leads to increasingly complex provisions. However, many of the current provisions have been added as prescriptive requirements relating to the design of irregularities in structural systems. It has been recognized that in order for buildings to be reliably constructed to resist earthquakes, it is necessary that the designers have sufficient understanding of the design provisions so that they can be properly implemented. It is feared that the typical designers of smaller, simpler structures, which possibly represent more than 90 percent of construction in the United States, may have difficulty understanding what the Provisions require in their present complex form.

In recognition of this, as part of the BSSC 2000 Provisions Update Cycle, a special task force was commissioned by BSSC to develop simplified procedures, acting as an ad-hoc group reporting to TS-2. The approach was to develop a simplified set of the Provisions for easier application to low-rise, stiff structures. The procedure was designed to be used within a defined set of structures deemed to be sufficiently regular in configuration to allow a reduction of prescriptive requirements. The procedure was refined and tested over the 2000 and 2003 cycles. It is presented as a stand-alone alternate procedure to Chapter 4. Significant characteristics of this alternative chapter include the following:

1. The simplified procedure would apply to structures up to three stories high in Seismic Design Categories B, C, D, and E, but would not be allowed for systems for which the design is typically controlled by considerations of drift. The task group concluded that this approach should be limited to certain structural systems in order to avoid problems that would arise from omitting the drift check for the drift-controlled systems (steel moment frames, for example). The simplified procedure is allowed for bearing wall and building frame systems, provided that several prescriptive rules are followed that result in a torsionally resistant, regular layout of lateral-load-resisting elements.
2. Given the prescriptive rules for system configuration, the definitions, tables, and design provisions for system irregularities become unnecessary.
3. The table of basic seismic-force-resisting systems has been shortened to include only allowable systems, and deflection amplification factors are not used and have been eliminated from the table.
4. Design and detailing requirements have been consolidated into a single set of provisions that do not vary with Seismic Design Category, largely due to sections rendered unnecessary with the prohibition of system irregularities.
5. The redundancy coefficient has been removed.
6. The procedure is limited to Site Classes A to D. At the same time, it is helpful in the simplified method to have default Site Class F_a values for buildings and regions where detailed geotechnical investigations may not be available to the structural engineer. A simple definition of rock sites is provided in Sec. Alt. 4.6.1. As a practical matter, it should be known from a rudimentary geotechnical investigation whether a site is rock or soil, and so additional seismic shear wave velocity tests or special 100-ft. deep borings will not be necessary when utilizing this procedure.

The default F_a values have also been set to mitigate the tendency for the SDC to be affected by the simplified S_{DS} value.

7. Vertical shear distribution is based on tributary weight. As a result, the special formula for calculation of diaphragm forces is removed, and calculations of diaphragm forces are greatly simplified. The base shear is based on the short period plateau and does not require calculation of the period. This base value is increased 25 percent to account for the vertical distribution method as well as other simplifications. A calibration study, Figure CAlt.4-1, covering a wide range of conditions indicates that the 25 percent adequately covers the simplifications without being overly conservative.
8. Simple rigidity analysis will be required for rigid diaphragm systems, but analysis of accidental torsion and dynamic amplification of torsion would not be required. Untopped metal deck, wood panel, or plywood sheathed diaphragms may be considered flexible, representing another simplification in calculations.
9. Calculations for period, drift, or P-delta effects need not be performed. 1percent drift is assumed when needed by requirements not covered in the simplified provisions. For example, in ACI 318, gravity columns are required to be designed for the calculated drift or to be specially detailed.

Calibration Study		Simplified Lateral Force Analysis Procedure					$V = 1.25S_{DS} / R$
$F_a =$		1 for rock		1.4 for soil			
$S_{Ds} =$		0.67		0.93			
$1.25S_{Ds} =$		0.83		1.17			
F_a Values		$Z \leq 0.067$	$Z = 0.13$	$Z = 0.20$	$Z = 0.27$	$Z \geq 0.33$	
Site Class		$S_s \leq 0.25$	$S_s = 0.50$	$S_s = 0.75$	$S_s = 1.00$	$S_s \geq 1.25$	
A	(hard rock)	0.80	0.80	0.80	0.80	0.80	
B	(rock)	1.00	1.00	1.00	1.00	1.00	
C	(soft rock)	1.20	1.20	1.10	1.00	1.00	
D	(stiff soil)	1.60	1.40	1.20	1.10	1.00	
Ratio of (Simplified S_{DS}) / ($S_{DS} = F_a \times 2/3 \times S_s$)							
Site Class		$S_s \leq 0.25$	$S_s = 0.50$	$S_s = 0.75$	$S_s = 1.00$	$S_s \geq 1.25$	
A	(hard rock)	1.25	1.25	1.25	1.25	1.25	
B	(rock)	1.00	1.00	1.00	1.00	1.00	
C	(soft rock)	0.83	0.83	0.91	1.00	1.00	
D	(stiff soil)	0.88	1.00	1.17	1.27	1.40	
Ratio of base shear for all buildings and overturning moment for one-story buildings							
Site Class		$S_s \leq 0.25$	$S_s = 0.50$	$S_s = 0.75$	$S_s = 1.00$	$S_s \geq 1.25$	
A	(hard rock)	1.56	1.56	1.56	1.56	1.56	
B	(rock)	1.25	1.25	1.25	1.25	1.25	
C	(soft rock)	1.04	1.04	1.14	1.25	1.25	
D	(stiff soil)	1.09	1.25	1.46	1.59	1.75	
Average net conservatism in overturning moment for two-story buildings							
Equal floor masses and first story height equal or up to 1.5 x second story							
Site Class		$S_s \leq 0.25$	$S_s = 0.50$	$S_s = 0.75$	$S_s = 1.00$	$S_s \geq 1.25$	
A	(hard rock)	1.44	1.44	1.44	1.44	1.44	
B	(rock)	1.15	1.15	1.15	1.15	1.15	
C	(soft rock)	0.96	0.96	1.05	1.15	1.15	
D	(stiff soil)	1.01	1.15	1.34	1.46	1.61	
Average net conservatism in overturning moment for three-story buildings							
Equal floor masses and first story height equal or up to 1.5 x typical story							
Site Class		$S_s \leq 0.25$	$S_s = 0.50$	$S_s = 0.75$	$S_s = 1.00$	$S_s \geq 1.25$	
A	(hard rock)	1.38	1.38	1.38	1.38	1.38	
B	(rock)	1.10	1.10	1.10	1.10	1.10	
C	(soft rock)	0.92	0.92	1.00	1.10	1.10	
D	(stiff soil)	0.96	1.10	1.28	1.40	1.54	
Bold values indicates Seismic Design Category D in the Equivalent Lateral Force Procedure.							
Bold Italic values indicates Seismic Design Category B in the Equivalent Lateral Force Procedure.							

Figure CAIt.4-1 Calibration Study.

This page is intentionally left blank.

Chapter 5 Commentary

STRUCTURAL ANALYSIS PROCEDURES

5.1 GENERAL

The equivalent lateral force (ELF) procedure specified in Sec. 5.2 is similar in its basic concept to SEAOC recommendations in 1968, 1973, and 1974, but several improved features have been incorporated. A significant revision to this procedure, which more closely reflects the ground motion response spectra, was adopted in the 1997 *Provisions* in parallel with a similar concept developed by SEAOC.

The modal superposition method is a general procedure for linear analysis of the dynamic response of structures. In various forms, modal analysis has been widely used in the earthquake-resistant design of special structures such as very tall buildings, offshore drilling platforms, dams, and nuclear power plants, for a number of years; however, its use is also becoming more common for ordinary structures as well. Prior to the 1997 edition of the *Provisions*, the modal analysis procedure specified in Sec. 5.3 was simplified from the general case by restricting consideration to lateral motion in a single plane. Only one degree of freedom was required per floor for this type of analysis. In recent years, with the advent of high-speed, desktop computers, and the proliferation of relatively inexpensive, user-friendly structural analysis software capable of performing three dimensional modal analyses, such simplifications have become unnecessary. Consequently, the 1997 *Provisions* adopted the more general approach describing a three-dimensional modal analysis of the structure. When modal analysis is specified by the *Provisions*, a three-dimensional analysis generally is required except in the case of highly regular structures or structures with flexible diaphragms.

The ELF procedure of Sec. 5.2 and the response spectrum procedure of Sec. 5.3 are both based on the approximation that the effects of yielding can be adequately accounted for by linear analysis of the seismic-force-resisting system for the design spectrum, which is the elastic acceleration response spectrum reduced by the response modification factor, R . The effects of the horizontal component of ground motion perpendicular to the direction under consideration in the analysis, the vertical component of ground motion, and torsional motions of the structure are all considered in the same simplified approaches in the two procedures. The main difference between the two procedures lies in the distribution of the seismic lateral forces over the height of the building. In the modal analysis procedure, the distribution is based on properties of the natural vibration modes, which are determined from the mass and stiffness distribution. In the ELF procedure, the distribution is based on simplified formulas that are appropriate for regular structures as specified in Sec. 5.2.3. Otherwise, the two procedures are subject to the same limitations.

The simplifications inherent in the ELF procedure result in approximations that are likely to be inadequate if the lateral motions in two orthogonal directions and the torsional motion are strongly coupled. Such would be the case if the building were irregular in its plan configuration (see Sec. 4.3.2.2) or if it had a regular plan but its lower natural frequencies were nearly equal and the centers of mass and resistance were nearly coincident. The modal analysis method introduced in the 1997 *Provisions* includes a general model that is more appropriate for the analysis of such structures. It requires at least three degrees of freedom per floor—two for translational motion and one for torsional motion.

The methods of modal analysis can be generalized further to model the effect of diaphragm flexibility, soil-structure interaction, etc. In the most general form, the idealization would take the form of a large number of mass points, each with six degrees of freedom (three translational and three rotational) connected by generalized stiffness elements.

The ELF procedure (Sec. 5.2) and the response spectrum procedure are all likely to err systematically on the unsafe side if story strengths are distributed irregularly over height. This feature is likely to lead to concentration of ductility demand in a few stories of the building. The nonlinear static (or so-called pushover) procedure is a method to more accurately account for irregular strength distribution. However, it also has limitations and is not particularly applicable to tall structures or structures with relatively long fundamental periods of vibration.

The actual strength properties of the various components of a structure can be explicitly considered only by a nonlinear analysis of dynamic response by direct integration of the coupled equations of motion. This method has been used extensively in earthquake research studies of inelastic structural response. If the two lateral motions and the torsional motion are expected to be essentially uncoupled, it would be sufficient to include only one degree of freedom per floor, for motion in the direction along which the structure is being analyzed; otherwise at least three degrees of freedom per floor, two translational and one torsional, should be included. It should be recognized that the results of a nonlinear response history analysis of such mathematical structural models are only as good as are the models chosen to represent the structure vibrating at amplitudes of motion large enough to cause significant yielding during strong ground motions. Furthermore, reliable results can be achieved only by calculating the response to several ground motions—recorded accelerograms and/or simulated motions—and examining the statistics of response.

It is possible with presently available computer programs to perform two- and three-dimensional inelastic analyses of reasonably simple structures. The intent of such analyses could be to estimate the sequence in which components become inelastic and to indicate those components requiring strength adjustments so as to remain within the required ductility limits. It should be emphasized that with the present state of the art in analysis, there is no one method that can be applied to all types of structures. Further, the reliability of the analytical results are sensitive to:

1. The number and appropriateness of the input motion records,
2. The practical limitations of mathematical modeling including interacting effects of inelastic elements,
3. The nonlinear solution algorithms, and
4. The assumed hysteretic behavior of members.

Because of these sensitivities and limitations, the maximum base shear produced in an inelastic analysis should not be less than that required by Sec. 5.2.

The least rigorous analytical procedure that may be used in determining the design seismic forces and deformations in structures depends on the Seismic Design Category and the structural characteristics (in particular, regularity). Regularity is discussed in Sec. 4.3.2.

Except for structures assigned to Seismic Design Category A, the ELF procedure is the minimum level of analysis except that a more rigorous procedure is required for some Category D, E and F structures as identified in Table 4.4-1. The modal analysis procedure adequately addresses vertical irregularities of stiffness, mass, or geometry, as limited by the *Provisions*. Other irregularities must be carefully considered.

The basis for the ELF procedure and its limitations were discussed above. It is adequate for most regular structures; however, the designer may wish to employ a more rigorous procedure (see list of procedures at beginning of this section) for those regular structures where the ELF procedure may be inadequate. The ELF procedure is likely to be inadequate in the following cases:

1. Structures with irregular mass and stiffness properties in which case the simple equations for vertical distribution of lateral forces (Eq. 5.2-10 and 5.2-11) may lead to erroneous results;
2. Structures (regular or irregular) in which the lateral motions in two orthogonal directions and the torsional motion are strongly coupled; and

3. Structures with irregular distribution of story strengths leading to possible concentration of ductility demand in a few stories of the building.

In such cases, a more rigorous procedure that considers the dynamic behavior of the structure should be employed.

Structures with certain types of vertical irregularities may be analyzed as regular structures in accordance with the requirements of Sec. 5.2. These structures are generally referred to as setback structures. The following procedure may be used:

1. The base and tower portions of a building having a setback vertical configuration may be analyzed as indicated in (2) below if:
 - a. The base portion and the tower portion, considered as separate structures, can be classified as regular and
 - b. The stiffness of the top story of the base is at least five times that of the first story of the tower.When these conditions are not met, the building must be analyzed in accordance with Sec. 5.3.
2. The base and tower portions may be analyzed as separate structures in accordance with the following:
 - a. The tower may be analyzed in accordance with the procedures in Sec. 5.2 with the base taken at the top of the base portion.
 - b. The base portion then must be analyzed in accordance with the procedures in Sec. 5.2 using the height of the base portion of h_n and with the gravity load and seismic base shear forces of the tower portion acting at the top level of the base portion.

The design requirements in Sec. 5.3 include a simplified version of modal analysis that accounts for irregularity in mass and stiffness distribution over the height of the building. It would be adequate, in general, to use the ELF procedure for structures whose floor masses and cross-sectional areas and moments of inertia of structural members do not differ by more than 30 percent in adjacent floors and in adjacent stories.

For other structures, the following procedure should be used to determine whether the modal analysis procedures of Sec. 5.3 should be used:

1. Compute the story shears using the ELF procedure specified in Sec. 5.2.
2. On this basis, approximately dimension the structural members, and then compute the lateral displacements of the floor.
3. Replace h in Eq. 5.2-11 with these displacements, and recompute the lateral forces to obtain the revised story shears.
4. If at any story the recomputed story shear differs from the corresponding value as obtained from the procedures of Sec. 5.2 by more than 30 percent, the building should be analyzed using the procedure of Sec. 5.3. If the difference is less than this value, the building may be designed using the story shear obtained in the application of the present criterion and the procedures of Sec. 5.3 are not required.

Application of this procedure to these structures requires far less computational effort than the use of the response spectrum procedure of Sec. 5.3. In the majority of the structures, use of this procedure will determine that modal analysis need not be used and will also furnish a set of story shears that practically always lie much closer to the results of modal analysis than the results of the ELF procedure.

This procedure is equivalent to a single cycle of Newmark's method for calculation of the fundamental mode of vibration. It will detect both unusual shapes of the fundamental mode and excessively high influence of higher modes. Numerical studies have demonstrated that this procedure for determining whether modal analysis must be used will, in general, detect cases that truly should be analyzed

dynamically; however, it generally will not indicate the need for dynamic analysis when such an analysis would not greatly improve accuracy.

5.2 EQUIVALENT LATERAL FORCE PROCEDURE

This section discusses the equivalent lateral force (ELF) procedure for seismic analysis of structures.

5.2.1 Seismic base shear. The heart of the ELF procedure is Eq. 5.2-1 for base shear, which gives the total seismic design force, V , in terms of two factors: a seismic response coefficient, C_s , and the seismic weight, W . The seismic response coefficient C_s , is obtained from Eq. 5.2-2 and 5.2-3 based on the design spectral response acceleration parameters, S_{DS} and S_{D1} . These acceleration parameters and the derivation of the response spectrum is discussed more fully in the *Commentary* for Chapter 3. The seismic weight is discussed in *Commentary* Sec. 1.5.1.

The base shear formula and the various factors contained therein were arrived at as explained below.

Elastic acceleration response spectrum. See the *Commentary* to Chapter 4 for a full discussion of the shape of the spectrum accounting for dynamic response amplification and the effect of site response.

Elastic design spectrum. The elastic acceleration response spectrum for earthquake motions has a descending branch for longer values of T , the period of vibration of the system, that varies roughly as a function of $1/T$. In previous editions of the *Provisions*, the actual response spectra that varied in a $1/T$ relationship were replaced with design spectra that varied in a $1/T^{2/3}$ relationship. This was intentionally done to provide added conservatism in the design of tall structures, as well as to account for the effects of higher mode participation. In the development of the 1997 *Provisions*, a special task force, known as the Seismic Design Procedures Group (SDPG), was convened to develop a method for using new seismic hazard maps, developed by the USGS in the *Provisions*. Whereas older seismic hazard maps provided an effective peak ground acceleration coefficient, C_a , and an effective peak velocity-related acceleration coefficient, C_v , the new maps directly provide parameters that correspond to points on the response spectrum. It was the recommendation of the SDPG that the true shape of the response spectrum, represented by a $1/T$ relationship, be used in the base shear equation. In order to maintain the added conservatism for tall and high occupancy structures, formerly provided by the design spectra which utilized a $1/T^{2/3}$ relationship, the 1997 *Provisions* adopted an occupancy importance factor I into the base shear equation. This I factor, which has a value of 1.25 for Seismic Use Group II structures and 1.5 for Seismic Use Group III structures has the effect of raising the design spectrum for taller, high occupancy structures, to levels comparable to those for which they were designed in previous editions of the *Provisions*.

Although the introduction of an occupancy importance factor in the 1997 edition adjusted the base shear to more conservative values for large buildings with higher occupancies, it did not address the issue of accounting for higher mode effects, which can be significant in longer period structures—those with fundamental modes of vibration significantly larger than the period T_s , at which the response spectrum changes from one of constant response acceleration (Eq. 5.2-2) to one of constant response velocity (Eq. 5.2-3).

Equation 5.2-3 could be modified to produce an estimate of base shear that is more consistent with the results predicted by elastic response spectrum methods. Some suggestions for such modifications may be found in Chopra (1995). However, it is important to note that even if the base shear equation were to simulate results of an elastic response spectrum analysis more accurately, most structures respond to design level ground shaking in an inelastic manner. This inelastic response results in different demands than are predicted by elastic analysis, regardless of how “exact” the analysis is. Inelastic response behavior in multistory buildings could be partially accounted for by other modifications to the seismic coefficient C_s . Specifically, the coefficient could be made larger to limit the ductility demand in multistory buildings to the same value as for single-degree-of-freedom systems. Results supporting such an approach may be found in (Chopra, 1995) and in (Nassar and Krawinkler, 1991).

The above notwithstanding, the equivalent lateral force procedure is intended to provide a relatively straightforward design approach where complex analyses, accurately accounting for dynamic and inelastic response effects, are not warranted. Rather than making the procedure more complex, so that it would be more appropriate for structures with significant higher mode response, in the 2000 edition of the *Provisions* application of this technique to structures assigned to Seismic Design Categories D, E, and F is limited to those where higher mode effects are not significant. Given the widespread use of computer-assisted analysis for major structures, it was felt that these limitations on the application of the equivalent lateral force procedure would not be burdensome. It should be noted that particularly for tall structures, the use of dynamic analysis methods will not only result in a more realistic characterization of the distribution of inertial forces in the structure, but may also result in reduced forces, particularly with regard to overturning demands. Therefore, use of a dynamic analysis method is recommended for such structures, regardless of the Seismic Design Category.

Historically, the ELF analytical approach has been limited in application in Seismic Design Categories D, E, and F to regular structures with heights of 240 ft (70 m) or less and irregular structures with heights of 100 ft (30 m) or less. Following recognition that the use of a base shear equation with a $1/T$ relationship underestimated the response of structures with significant higher mode participation, a change in the height limit for regular structures to 100 ft (30 m) was contemplated. However, the importance of higher mode participation in structural response is a function both of the structure's dynamic properties, which are dependent on height, mass and the stiffness of various lateral force resisting elements, and of the frequency content of the ground shaking, as represented by the response spectrum. Therefore, rather than continuing to use building height as the primary parameter used to control analysis procedures, it was decided to limit the application of the ELF to those structures in Seismic Design Categories D, E, and F having fundamental periods of response less than 3.5 times the period at which the response spectrum transitions from constant response acceleration to constant response velocity. This limit was selected based on comparisons of the base shear calculated by the ELF equations to that predicted by response spectrum analysis for structures of various periods on five different sites, representative of typical conditions in the eastern and western United States. For all 5 sites, it was determined that the ELF equations conservatively bound the results of a response spectrum analysis for structures having periods lower than the indicated amount.

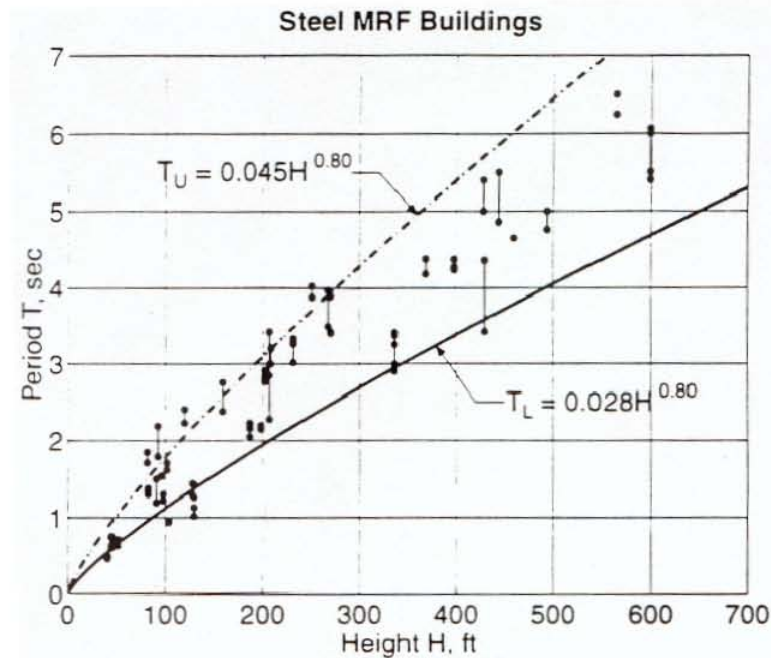

Figure C5.2-2 Measured building period for moment-resisting steel frame structures.

Response modification factor. The factor R in the denominator of Eq. 5.2-2 and 5.2-3 is an empirical response reduction factor intended to account for damping, overstrength, and the ductility inherent in the structural system at displacements great enough to surpass initial yield and approach the ultimate load displacement of the structural system. Thus, for a lightly damped building structure of brittle material that would be unable to tolerate any appreciable deformation beyond the elastic range, the factor R would be close to 1 (that is, no reduction from the linear elastic response would be allowed). At the other extreme, a heavily damped building structure with a very ductile structural system would be able to withstand deformations considerably in excess of initial yield and would, therefore, justify the assignment of a larger response reduction factor R . Table 4.3-1 in the *Provisions* stipulates R factors for different types of building systems using several different structural materials. The coefficient R ranges in value from a minimum of $1\frac{1}{4}$ for an unreinforced masonry bearing wall system to a maximum of 8 for a special moment frame system. The basis for the R factor values specified in Table 4.3-1 is explained in the *Commentary* to Sec. 4.2.1.

The effective value of R used in the base shear equation is adjusted by the occupancy importance factor I . The value of I , which ranges from 1 to 1.5, has the effect of reducing the amount of ductility the structure will be called on to provide at a given level of ground shaking. However, it must be recognized that added strength, by itself, is not adequate to provide for superior seismic performance in buildings with critical occupancies. Good connections and construction details, quality assurance procedures, and limitations on building deformation or drift are also important to significantly improve the capability for maintenance of function and safety in critical facilities and those with a high-density occupancy. Consequently, the reduction in the damage potential of critical facilities (Group III) is also handled by using more conservative drift controls (Sec. 4.5.1) and by providing special design and detailing requirements (Sec. 4.6) and materials limitations (Chapters 8 through 12).

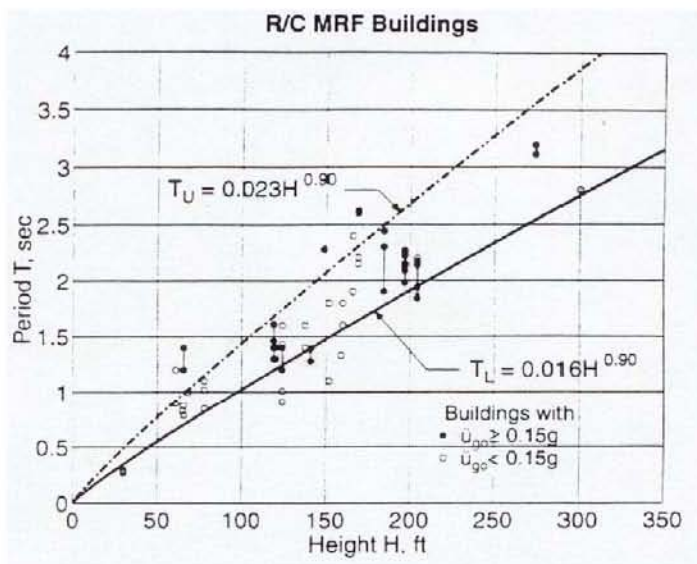

Figure C5.2-1 Measured building period for reinforced concrete frame structures.

5.2.2 Period determination. In the denominator of Eq. 5.2-3, T is the fundamental period of vibration of the structure. It is preferable that this be determined using modal analysis methods and the principles of structural mechanics. However, methods of structural mechanics cannot be employed to calculate the vibration period before a structure has been designed. Consequently, this section provides an approximate method that can be used to estimate the period, with minimal information available on the design. It is based on the use of simple formulas that involve only a general description of the type of

structure (such as steel moment frame, concrete moment frame, shear wall system, braced frame) and overall dimensions (such as height and plan length) to estimate the period of vibration in order to calculate an initial base shear and proceed with a preliminary design.

It is advisable that this base shear and the corresponding value of T be conservative.

Even for final design, use of an unrealistically large value for T is unconservative. Thus, the value of T used in design should be smaller than the period calculated for the bare frame of the building. Equations 5.2-6, 5.2-7, and 5.2-8 for the approximate period T_a are therefore intended to provide conservative estimates of the fundamental period of vibration. An upper bound is placed on the value of T calculated using more exact methods, based on T_a and the factor C_u . The coefficient C_u is intended to reflect the likelihood that buildings in areas with lower lateral force requirements probably will be more flexible. Furthermore, it results in less dramatic changes from present practice in lower risk areas. It is generally accepted that the empirical equations for T_a are tailored to fit the type of construction common in areas with high lateral force requirements. It is unlikely that buildings in lower risk seismic areas would be designed to produce as high a drift level as allowed in the *Provisions* due to stability problems (P -delta) and wind requirements. Where the design of a structure is actually “controlled” by wind, the use of a large T will not really result in a lower design force; thus, use of this approach in high-wind regions should not result in unsafe design.

Taking the seismic base shear to vary as a function of $1/T$ and assuming that the lateral forces are distributed linearly over the height and that the deflections are controlled by drift limitations, a simple calculation of the period of vibration by Rayleigh’s method leads to the conclusion that the vibration period of moment resisting frame structures varies roughly as $h_n^{3/4}$ where h_n equals the total height of the building as defined elsewhere. Based on this, for many years Eq. 5.2-6 appeared in the *Provisions* in the form:

$$T_a = C_t h_n^{3/4}$$

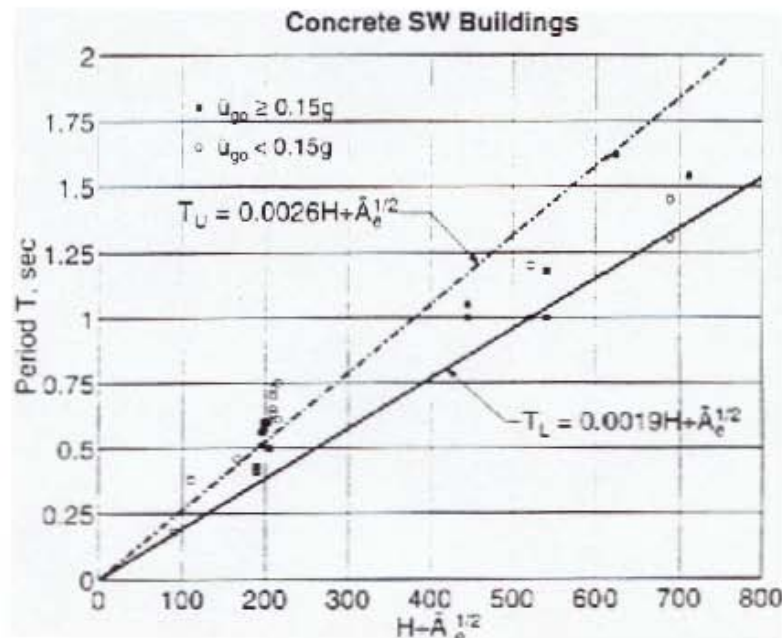

Figure C5.2-3 Measured building period for concrete shear wall structures.

A large number of strong motion instruments have been placed in buildings located within zones of high seismic activity by the U.S. Geological Survey and the California Division of Mines and Geology. Over the past several years, this has allowed the response to strong ground shaking for a significant number of these buildings to be recorded and the fundamental period of vibration of the buildings to be calculated.

Figures C5.2-1, C5.2-2, and C5.2-3, respectively, show plots of these data as a function of building height for three classes of structures. Figure C5.2-1 shows the data for moment-resisting concrete frame buildings; Figure C5.2-2, for moment-resisting steel frame buildings; and Figure C5.2-3, for concrete shear wall buildings. Also shown in these figures are equations for lines that envelop the data within approximately a standard deviation above and below the mean.

For the 2000 *Provisions*, Eq. 5.2-6 is revised into a more general form allowing the statistical fits of the data shown in the figures to be used directly. The values of the coefficient C_r and the exponent x given in Table 5.2-2 for these moment-resisting frame structures represent the lower bound (mean minus one standard deviation) fits to the data shown in Figures C5.2-1 and C5.2-2, respectively, for steel and concrete moment frames. Although updated data were available for concrete shear wall structures, these data do not fit well with an equation of the form of Eq. 5.2-6. This is because the period of shear wall buildings is highly dependent not only on the height of the structure but also on the amount of shear wall present in the building. Analytical evaluations performed by Chopra and Goel (1997 and 1998) indicate that equations of the form of Eq. 5.2-8 and 5.2-9 provide a reasonably good fit to the data. However, the form of these equations is somewhat complex. Therefore, the simpler form of Eq. 5.2-6 contained in earlier editions of the *Provisions* was retained with the newer, more accurate formulation presented as an alternative.

Updated data for other classes of construction were not available. As a result, the C_r and x values for other types of construction shown in Table 5.2-2 are values largely based on limited data obtained from the 1971 San Fernando earthquake that have been used in past editions of the *Provisions*. The optional use of $T = 0.1N$ (Eq. 5.2-7) is an approximation for low to moderate height frames that has long been in use.

In earlier editions of the *Provisions*, the C_u coefficient varied from a value of 1.2 in zones of high seismicity to a value of 1.7 in zones of low seismicity. The data presented in Figures C5.2-1, C5.2-2, and C5.2-3 permit direct evaluation of the upper bound on period as a function of the lower bound, given by Eq. 5.2-6. This data indicates that in zones of high seismicity, the ratio of the upper to lower bound may more properly be taken as a value of about 1.4. Therefore, in the 2000 *Provisions*, the values in Table 5.2-1 were revised to reflect this data in zones of high seismicity while retaining the somewhat subjective values contained in earlier editions for the zones of lower seismicity.

For exceptionally stiff or light buildings, the calculated T for the seismic-force-resisting system may be significantly shorter than T_a calculated by Eq. 5.2-6. For such buildings, it is recommended that the period value T be used in lieu of T_a for calculating the seismic response coefficient, C_s .

Although the approximate methods of Sec. 5.2.2.1 can be used to determine a period for the design of structures, the fundamental period of vibration of the seismic-force-resisting system should be calculated according to established methods of mechanics. Computer programs are available for such calculations. One method of calculating the period, probably as convenient as any, is the use of the following formula based on Rayleigh's method:

$$T = 2\pi \sqrt{\frac{\sum_{i=1}^n w_i \delta_i^2}{g \sum_{i=1}^n F_i \delta_i}} \quad (\text{C5.2-1})$$

where:

F_i = the seismic lateral force at Level i ,

- w_i = the seismic weight assigned in Level i ,
 δ_i = the static lateral displacement at Level i due to the forces F_i computed on a linear elastic basis, and
 g = is the acceleration due to gravity.

The calculated period increases with an increase in flexibility of the structure because the δ term in the Rayleigh formula appears to the second power in the numerator but to only the first power in the denominator. Thus, if one ignores the contribution of nonstructural elements to the stiffness of the structure in calculating the deflections δ , the deflections are exaggerated and the calculated period is lengthened, leading to a decrease in the seismic response coefficient C_s and, therefore, a decrease in the design force. Nonstructural elements participate in the behavior of the structure even though the designer may not rely on them to contribute any strength or stiffness to the structure. To ignore them in calculating the period is to err on the unconservative side. The limitation of $C_u T_a$ is imposed as a safeguard.

5.2.3 Vertical distribution of seismic forces. The distribution of lateral forces over the height of a structure is generally quite complex because these forces are the result of superposition of a number of natural modes of vibration. The relative contributions of these vibration modes to the total forces depends on a number of factors including the shape of the earthquake response spectrum, the natural periods of vibration of the structure, and the shapes of vibration modes that, in turn, depend on the distribution of mass and stiffness over the height. The basis of this method is discussed below. In structures having only minor irregularity of mass or stiffness over the height, the accuracy of the lateral force distribution as given by Eq. 5.2-11 is much improved by the procedure described in the last portion of Sec. 5.1 of this commentary. The lateral force at each level, x , due to response in the first (fundamental) natural mode of vibration is given by Eq. C5.2-2 as follows:

$$f_{x1} = V_1 \left[\frac{w_x \phi_{x1}}{\sum_{i=1}^n w_i \phi_{i1}} \right] \quad (\text{C5.2-2})$$

where:

- V_1 = the contribution of this mode to the base shear,
 w_i = the weight lumped at the i th level, and
 ϕ_i = the amplitude of the first mode at the i^{th} level.

This is the same as Eq. 5.3-7 in Sec. 5.3.5 of the *Provisions*, but it is specialized for the first mode. If V_1 is replaced by the total base shear, V , this equation becomes identical to Eq. 5.2-11 with $k = 1$ if the first mode shape is a straight line and with $k = 2$ if the first mode shape is a parabola with its vertex at the base.

It is well known that the influence of modes of vibration higher than the fundamental mode is small in the earthquake response of short period structures and that, in regular structures, the fundamental vibration mode departs little from a straight line. This, along with the matters discussed above, provides the basis for Eq. 5.2-11 with $k = 1$ for structures having a fundamental vibration period of 0.5 seconds or less.

It has been demonstrated that although the earthquake response of long period structures is primarily due to the fundamental natural mode of vibration, the influence of higher modes of vibration can be significant and, in regular structures, the fundamental vibration mode lies approximately between a straight line and a parabola with the vertex at the base. Thus, Eq. 5.2-11 with $k = 2$ is appropriate for structures having a fundamental period of vibration of 2.5 seconds or longer. Linear variation of k between 1 at a 0.5 second period and 2 at a 2.5 seconds period provides the simplest possible transition between the two extreme values.

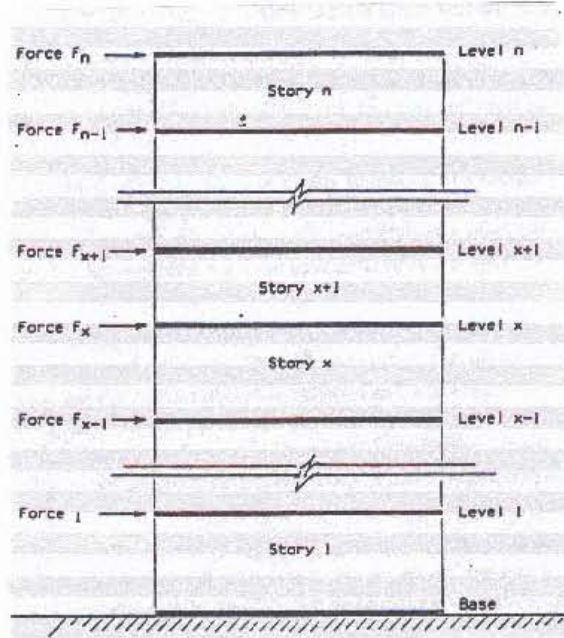

Figure C5.2-4 Description of story and level.
 The shear at Story x (V_x) is the sum of all the lateral forces at and above Story x (F_x through F_n).

5.2.4 Horizontal shear distribution. The story shear in any story is the sum of the lateral forces acting at all levels above that story. Story x is the story immediately below Level x (Figure C5.2-4). Reasonable and consistent assumptions regarding the stiffness of concrete and masonry elements may be used for analysis in distributing the shear force to such elements connected by a horizontal diaphragm. Similarly, the stiffness of moment or braced frames will establish the distribution of the story shear to the vertical resisting elements in that story.

5.2.4.1 and 5.2.4.2 Inherent and accidental torsion. The torsional moment to be considered in the design of elements in a story consists of two parts:

1. M_t , the moment due to eccentricity between centers of mass and resistance for that story, which is computed as the story shear times the eccentricity perpendicular to the direction of applied earthquake forces.
2. M_{ta} , commonly referred to as “accidental torsion,” which is computed as the story shear times the “accidental eccentricity,” equal to 5 percent of the dimension of the structure (in the story under consideration) perpendicular to the direction of the applied earthquake forces.

Computation of M_{ta} in this manner is equivalent to the procedure in Sec. 5.2.4.2 which implies that the dimension of the structure is the dimension in the story where the torsional moment is being computed and that all the masses above that story should be assumed to be displaced in the same direction at one time (for example, first, all of them to the left and, then, to the right).

Dynamic analyses assuming linear behavior indicate that the torsional moment due to eccentricity between centers of mass and resistance may significantly exceed M_t (Newmark and Rosenblueth, 1971). However, such dynamic magnification is not included in the *Provisions*, partly because its significance is not well understood for structures designed to deform well beyond the range of linear behavior.

The torsional moment M_t calculated in accordance with this provision would be zero in those stories where centers of mass and resistance coincide. However, during vibration of the structure, torsional moments would be induced in such stories due to eccentricities between centers of mass and resistance in other stories. To account for such effects, it is recommended that the torsional moment in any story be no smaller than the following two values (Newmark and Rosenblueth, 1971):

1. The story shear times one-half of the maximum of the computed eccentricities in all stories below the one being analyzed and
2. One-half of the maximum of the computed torsional moments for all stories above.

Accidental torsion is intended to cover the effects of several factors that have not been explicitly considered in the *Provisions*. These factors include the rotational component of ground motion about a vertical axis; unforeseeable differences between computed and actual values of stiffness, yield strengths, and dead-load masses; and unforeseeable unfavorable distributions of dead- and live-load masses.

The way in which the story shears and the effects of torsional moments are distributed to the vertical elements of the seismic-force-resisting system depends on the stiffness of the diaphragms relative to vertical elements of the system.

Where the diaphragm stiffness in its own plane is sufficiently high relative to the stiffness of the vertical components of the system, the diaphragm may be assumed to be indefinitely rigid for purposes of this section. Then, in accordance with compatibility and equilibrium requirements, the shear in any story is to be distributed among the vertical components in proportion to their contributions to the lateral stiffness of the story while the story torsional moment produces additional shears in these components that are proportional to their contributions to the torsional stiffness of the story about its center of resistance. This contribution of any component is the product of its lateral stiffness and the square of its distance to the center of resistance of the story. Alternatively, the story shears and torsional moments may be distributed on the basis of a three-dimensional analysis of the structure, consistent with the assumption of linear behavior.

Where the diaphragm in its own plane is very flexible relative to the vertical components, each vertical component acts nearly independently of the rest. The story shear should be distributed to the vertical components considering these to be rigid supports. Analysis of the diaphragm acting as a continuous horizontal beam or truss on rigid supports leads to the distribution of shears. Because the properties of the beam or truss may not be accurately computed, the shears in vertical elements should not be taken to be less than those based on “tributary areas.” Accidental torsion may be accounted for by adjusting the position of the horizontal force with respect to the supporting vertical elements.

There are some common situations where it is obvious that the diaphragm can be assumed to be either rigid or very flexible in its own plane for purposes of distributing story shear and considering torsional moments. For example, a solid monolithic reinforced concrete slab, square or nearly square in plan, in a structure with slender moment resisting frames may be regarded as rigid. A large plywood diaphragm with widely spaced and long, low masonry walls may be regarded as very flexible. In intermediate situations, the design forces should be based on an analysis that explicitly considers diaphragm deformations and satisfies equilibrium and compatibility requirements. Alternatively, the design forces could be based on the envelope of the two sets of forces resulting from both extreme assumptions regarding the diaphragms—rigid or very flexible.

Where the horizontal diaphragm is not continuous and the elements perpendicular to the direction of motion are ignored, the story shear can be distributed to the vertical components based on their tributary areas.

5.2.4.3 Dynamic amplification of torsion. There are indications that the 5 percent accidental eccentricity may be too small in some structures since they may develop torsional dynamic instability. Some examples are the upper stories of tall structures having little or no nominal eccentricity, those structures where the calculations of relative stiffnesses of various elements are particularly uncertain (such as those that depend largely on masonry walls for lateral force resistance or those that depend on

vertical elements made of different materials), and nominally symmetrical structures that utilize core elements alone for seismic resistance or that behave essentially like elastic nonlinear systems (for example, some prestressed concrete frames). The amplification factor for torsionally irregular structures (Eq. 5.2-13) was introduced in the 1988 Edition as an attempt to account for some of these problems in a controlled and rational way.

5.2.5 Overturning. This section requires that the structure be designed to resist overturning moments statically consistent with the design story shears. In the 1997 and earlier editions of the *Provisions*, the overturning moment was modified by a factor, τ , to account, in an approximate manner, for the effects of higher mode response in taller structures. In the 2000 edition of the *Provisions*, the equivalent lateral force procedure was limited in application in Seismic Design Categories D, E, and F to structures that do not have significant higher mode participation. As a result it was possible to simplify the design procedure by eliminating the τ factor. Under this new approach tall structures in Seismic Design Categories B and C designed using the equivalent lateral force procedure will be designed for somewhat larger overturning demands than under past editions of the *Provisions*. This conservatism was accepted as an inducement for designers of such structures to use a more appropriate dynamic analysis procedure.

In the design of the foundation, the overturning moment calculated at the foundation-soil interface may be reduced to 75 percent of the calculated value using Eq. 5.2-14. This is appropriate because a slight uplifting of one edge of the foundation during vibration leads to reduction in the overturning moment and because such behavior does not normally cause structural distress.

5.2.6 Drift determination and *P*-delta effects. This section defines the design story drift as the difference of the deflections, δ_x , at the top and bottom of the story under consideration. The deflections, δ_x , are determined by multiplying the deflections, δ_{xe} (determined from an elastic analysis), by the deflection amplification factor, C_d , given in Table 4.3-1. The elastic analysis is to be made for the seismic-force-resisting system using the prescribed seismic design forces and considering the structure to be fixed at the base. Stiffnesses other than those of the seismic-force-resisting system should not be included since they may not be reliable at higher inelastic strain levels.

The deflections are to be determined by combining the effects of joint rotation of members, shear deformations between floors, the axial deformations of the overall lateral resisting elements, and the shear and flexural deformations of shear walls and braced frames. The deflections are determined initially on the basis of the distribution of lateral forces stipulated in Sec. 5.2.3. For frame structures, the axial deformations from bending effects, although contributing to the overall structural distortion, may or may not affect the story-to-story drift; however, they are to be considered. Centerline dimensions between the frame elements often are used for analysis, but clear-span dimensions with consideration of joint panel zone deformation also may be used.

For determining compliance with the story drift limitation of Sec. 4.5.1, the deflections, δ_x , may be calculated as indicated above for the seismic-force-resisting system and design forces corresponding to the fundamental period of the structure, T (calculated without the limit $T \leq C_u T_a$ specified in Sec. 5.2.2), may be used. The same model of the seismic-force-resisting system used in determining the deflections must be used for determining T . The waiver does not pertain to the calculation of drifts for determining *P*-delta effects on member forces, overturning moments, etc. If the *P*-delta effects determined in Sec. 5.2.6.2 are significant, the design story drift must be increased by the resulting incremental factor.

The *P*-delta effects in a given story are due to the eccentricity of the gravity load above that story. If the story drift due to the lateral forces prescribed in Sec. 5.2.3 were Δ , the bending moments in the story would be augmented by an amount equal to Δ times the gravity load above the story. The ratio of the *P*-delta moment to the lateral force story moment is designated as a stability coefficient, θ , in Eq. 5.2-16. If the stability coefficient θ is less than 0.10 for every story, the *P*-delta effects on story shears and moments and member forces may be ignored. If, however, the stability coefficient θ exceeds 0.10 for any story, the *P*-delta effects on story drifts, shears, member forces, etc., for the whole structure must be determined by a rational analysis.

An acceptable *P*-delta analysis, based upon elastic stability theory, is as follows:

1. Compute for each story the P -delta amplification factor, $a_d = \theta/(1 - \theta)$. a_d takes into account the multiplier effect due to the initial story drift leading to another increment of drift that would lead to yet another increment, etc. Thus, both the effective shear in the story and the computed eccentricity would be augmented by a factor $1 + \theta + \theta^2 + \theta^3 \dots$, which is $1/(1 - \theta)$ or $(1 + a_d)$.
2. Multiply the story shear, V_x , in each story by the factor $(1 + a_d)$ for that story and recompute the story shears, overturning moments, and other seismic force effects corresponding to these augmented story shears.

This procedure is applicable to planar structures and, with some extension, to three-dimensional structures. Methods exist for incorporating two- and three-dimensional P -delta effects into computer analyses that do not explicitly include such effects (Rutenberg, 1985). Many programs explicitly include P -delta effects. A mathematical description of the method employed by several popular programs is given by Wilson and Habibullah (1987).

The P -delta procedure cited above effectively checks the static stability of a structure based on its initial stiffness. Since the inception of this procedure with ATC 3-06, however, there has been some debate regarding its accuracy. This debate stems from the intuitive notion that the structure's secant stiffness would more accurately represent inelastic P -delta effects. Given the additional uncertainty of the effect of dynamic response on P -delta behavior and the (apparent) observation that instability-related failures rarely occur in real structures, the P -delta requirements remained as originally written until revised for the 1991 Edition.

There was increasing evidence that the use of elastic stiffness in determining *theoretical* P -delta response is unconservative. Given a study carried out by Bernal (1987), it was argued that P -delta amplifiers should be based on secant stiffness and that, in other words, the C_d term in Eq. 5.2-16 should be deleted. However, since Bernal's study was based on the inelastic response of single-degree-of-freedom, elastic-perfectly plastic systems, significant uncertainties existed regarding the extrapolation of the concepts to the complex hysteretic behavior of multi-degree-of-freedom systems.

Another problem with accepting a P -delta procedure based on secant stiffness is that design forces would be greatly increased. For example, consider an ordinary moment frame of steel with a C_d of 4.0 and an elastic stability coefficient θ of 0.15. The amplifier for this structure would be $1.0/0.85 = 1.18$ according to the 1988 Edition of the *Provisions*. If the P -delta effects were based on secant stiffness, however, the stability coefficient would increase to 0.60 and the amplifier would become $1.0/0.4 = 2.50$. This example illustrates that there could be an extreme impact on the requirements if a change were implemented that incorporated P -delta amplifiers based on static secant stiffness response.

There was, however, some justification for retaining the P -delta amplifier as based on elastic stiffness. This justification was the apparent lack of stability-related failures. The reasons for the lack of observed failures included:

1. Many structures display strength well above the strength implied by code-level design forces (see Figure C4.2-3). This overstrength likely protects structures from stability-related failures.
2. The likelihood of a failure due to instability decreases with increased intensity of expected ground-shaking. This is due to the fact that the stiffness of most structures designed for extreme ground motion is significantly greater than the stiffness of the same structure designed for lower intensity shaking or for wind. Since damaging, low-intensity earthquakes are somewhat rare, there would be little observable damage.

Due to the lack of stability-related failures, therefore, recent editions of the *Provisions* regarding P -delta amplifiers have remained from the 1991 Editions.

The 1991 Edition introduced a requirement that the computed stability coefficient, θ , not exceed 0.25 or $0.5/\beta C_d$, where βC_d is an adjusted ductility demand that takes into account the fact that the seismic strength demand may be somewhat less than the code strength supplied. The adjusted ductility demand is

not intended to incorporate overstrength beyond that computed by the means available in Chapters 8 through 14 of the *Provisions*.

The purpose of this requirement is to protect structures from the possibility of stability failures triggered by post-earthquake residual deformation. The danger of such failures is real and may not be eliminated by apparently available overstrength. This is particularly true of structures designed in regions of lower seismicity.

The computation of θ_{max} , which, in turn, is based on βC_d , requires the computation of story strength supply and story strength demand. Story strength demand is simply the seismic design shear for the story under consideration. The story strength supply may be computed as the shear in the story that occurs simultaneously with the attainment of the development of first significant yield of the overall structure. To compute first significant yield, the structure should be loaded with a seismic force pattern similar to that used to compute seismic story strength demand. A simple and conservative procedure is to compute the ratio of demand to strength for each member of the seismic-force-resisting system in a particular story and then use the largest such ratio as β . For a structure otherwise in conformance with the *Provisions*, taking β equal to 1.0 is obviously conservative.

The principal reason for inclusion of β is to allow for a more equitable analysis of those structures in which substantial extra strength is provided, whether as a result of added stiffness for drift control, for code-required wind resistance, or simply a feature of other aspects of the design. Some structures inherently possess more strength than required, but instability is not typically a concern for such structures. For many flexible structures, the proportions of the structural members are controlled by the drift requirements rather than the strength requirements; consequently, β is less than 1.0 because the members provided are larger and stronger than required. This has the effect of reducing the inelastic component of total seismic drift and, thus, β is placed as a factor on C_d .

Accurate evaluation of β would require consideration of all pertinent load combinations to find the maximum value of seismic load effect demand to seismic load effect capacity in each and every member. A conservative simplification is to divide the total demand with seismic included by the total capacity; this covers all load combinations in which dead and live effects add to seismic. If a member is controlled by a load combination where dead load counteracts seismic, to be correctly computed, the ratio β must be based only on the seismic component, not the total; note that the vertical load P in the P -delta computation would be less in such a circumstance and, therefore, θ would be less. The importance of the counteracting load combination does have to be considered, but it rarely controls instability.

5.3 RESPONSE SPECTRUM PROCEDURE

Modal analysis (Newmark and Rosenblueth, 1971; Clough and Penzien, 1975; Thomson, 1965; Wiegel, 1970) is applicable for calculating the linear response of complex, multi-degree-of-freedom structures and is based on the fact that the response is the superposition of the responses of individual natural modes of vibration, each mode responding with its own particular pattern of deformation (the mode shape), with its own frequency (the modal frequency), and with its own modal damping. The response of the structure, therefore, can be modeled by the response of a number of single-degree-of-freedom oscillators with properties chosen to be representative of the mode and the degree to which the mode is excited by the earthquake motion. For certain types of damping, this representation is mathematically exact and, for structures, numerous full-scale tests and analyses of earthquake response of structures have shown that the use of modal analysis, with viscously damped single-degree-of-freedom oscillators describing the response of the structural modes, is an accurate approximation for analysis of linear response.

Modal analysis is useful in design. The ELF procedure of Sec. 5.2 is simply a first mode application of this technique, which assumes all of the structure's mass is active in the first mode. The purpose of modal analysis is to obtain the maximum response of the structure in each of its important modes, which are then summed in an appropriate manner. This maximum modal response can be expressed in several ways. For the *Provisions*, it was decided that the modal forces and their distributions over the structure should be given primary emphasis to highlight the similarity to the equivalent static methods traditionally

used in building codes (the SEAOC recommendations and the *UBC*) and the ELF procedure in Sec. 5.2. Thus, the coefficient C_{sm} in Eq. 5.3-3 and the distribution equations, Eq. 5.3-1 and 5.3-2, are the counterparts of Eq. 5.2-10 and 5.2-11. This correspondence helps clarify the fact that the simplified modal analysis contained in Sec. 5.3 is simply an attempt to specify the equivalent lateral forces on a structure in a way that directly reflects the individual dynamic characteristics of the structure. Once the story shears and other response variables for each of the important modes are determined and combined to produce design values, the design values are used in basically the same manner as the equivalent lateral forces given in Sec. 5.2.

5.3.2 Modes. This section defines the number of modes to be used in the analysis. For many structures, including low-rise structures and structures of moderate height, three modes of vibration in each direction are nearly always sufficient to determine design values of the earthquake response of the structure. For high-rise structures, however, more than three modes may be required to adequately determine the forces for design. This section provides a simple rule that the combined participating mass of all modes considered in the analysis should be equal to or greater than 90 percent of the effective total mass in each of two orthogonal horizontal directions.

5.3.3 Modal properties. Natural periods of vibration are required for each of the modes used in the subsequent calculations. These are needed to determine the modal coefficients C_{sm} in Sec. 5.3.4. Because the periods of the modes contemplated in these requirements are those associated with moderately large, but still essentially linear, structural response, the period calculations should include only those elements that are effective at these amplitudes. Such periods may be longer than those obtained from a small-amplitude test of the structure when completed or the response to small earthquake motions because of the stiffening effects of nonstructural and architectural components of the structure at small amplitudes. During response to strong ground-shaking, however, measured responses of structures have shown that the periods lengthen, indicating the loss of the stiffness contributed by those components.

There exists a wide variety of methods for calculation of natural periods and associated mode shapes, and no one particular method is required by the *Provisions*. It is essential, however, that the method used be one based on generally accepted principles of mechanics such as those given in well known textbooks on structural dynamics and vibrations (Clough and Penzien, 1975; Newmark and Rosenblueth, 1971; Thomson, 1965; Wiegel, 1970). Although it is expected that in many cases computer programs, whose accuracy and reliability are documented and widely recognized, will be used to calculate the required natural periods and associated mode shapes, their use is not required.

5.3.4 Modal base shear. A central feature of modal analysis is that the earthquake response is considered as a combination of the independent responses of the structure vibrating in each of its important modes. As the structure vibrates back and forth in a particular mode at the associated period, it experiences maximum values of base shear, story drifts, floor displacements, base (overturning) moments, etc. In this section, the base shear in the m^{th} mode is specified as the product of the modal seismic coefficient C_{sm} and the effective weight W_m for the mode. The coefficient C_{sm} is determined for each mode from Eq. 5.3-3 using the spectral acceleration S_{am} at the associated period of the mode, T_m , in addition to the R , which is discussed elsewhere in the *Commentary*. An exception to this procedure occurs for higher modes of those structures that have periods shorter than 0.3 second and that are founded on soils of Site Class D, E, or F. For such modes, Eq. 5.3-4 is used. Equation 5.3-4 gives values ranging from $0.4S_{Ds}/R$ for very short periods to S_{Ds}/R for $T_m = 0.3$. Comparing these values to the limiting values of C_s of S_{Ds}/R for Site Class D, it is seen that the use of Eq. 5.3-4, when applicable, reduces the modal base shear. This is an approximation introduced in consideration of the conservatism embodied in using the spectral shape specified in Sec. 3.3.4. The spectral shape so defined is a conservative approximation to average spectra that are known to first ascend, level off, and then decay as period increases. The design spectrum defined in Sec. 3.3.4 is somewhat more conservative. For Site Classes A, B, and C, the ascending portion of the spectra is completed at or below periods of 0.1 to 0.2 second. On the other hand, for soft soils the ascent may not be completed until a larger period is reached. Equation 5.3-4 is then a replacement for the spectral shape for Site Classes D, E and F and short periods that is more consistent with spectra for measured accelerations. It was introduced because it was judged unnecessarily

conservative to use Eq. 3.3-5 for modal analysis of structures assigned to Site Classes D, E, and F. The effective modal seismic weight given in Eq. 5.3-2 can be interpreted as specifying the portion of the weight of the structure that participates in the vibration of each mode. It is noted that Eq. 5.3-2 gives values of W_m that are independent of how the modes are normalized.

The final equation of this section, Eq. 5.3-5, is to be used if a modal period exceeds 4 seconds. It can be seen that Eq. 5.3-5 and 5.3-3 coincide at T_m equal to 4 seconds so that the effect of using Eq. 5.3-5 is to provide a more rapid decrease in C_{sm} as a function of the known characteristics of earthquake response spectra at intermediate and long periods. At intermediate periods, the average velocity spectrum of strong earthquake motions from large (magnitude 6.5 and larger) earthquakes is approximately constant, which implies that C_{sm} should decrease as $1/T_m$. For very long periods, the average displacement spectrum of strong earthquake motions becomes constant which implies that C_{sm} , a form of acceleration spectrum, should decay as $1/T_m^2$. The period at which the displacement response spectrum becomes constant depends on the size of the earthquake, being larger for great earthquakes, and a representative period of 4 seconds was chosen to make the transition.

5.3.5 Modal forces, deflections, and drifts. This section specifies the forces and displacements associated with each of the important modes of response.

Modal forces at each level are given by Eq. 5.3-6 and 5.3-7 and are expressed in terms of the seismic weight assigned to the floor, the mode shape, and the modal base shear V_m . In applying the forces F_{xm} to the structure, the direction of the forces is controlled by the algebraic sign of f_{xm} . Hence, the modal forces for the fundamental mode will all act in the same direction, but modal forces for the second and higher modes will change direction as one moves up the structure. The form of Eq. 5.3-6 is somewhat different from that usually employed in standard references and shows clearly the relation between the modal forces and the modal base shear. It, therefore, is a convenient form for calculation and highlights the similarity to Eq. 5.2-10 in the ELF procedure.

The modal deflections at each level are specified by Eq. 5.3-8 and 5.3-9. These are the displacements caused by the modal forces F_{xm} considered as static forces and are representative of the maximum amplitudes of modal response for the essentially elastic motions envisioned within the concept of the seismic response modification coefficient R . If the mode under consideration dominates the earthquake response, the modal deflection under the strongest motion contemplated by the *Provisions* can be estimated by multiplying by the deflection amplification factor C_d . It should be noted that δ_{xm} is proportional to ϕ_{xm} (this can be shown with algebraic substitution for F_{xm} in Eq. 5.3-9) and will therefore change direction up and down the structure for the higher modes.

5.3.6 Modal story shears and moments. This section merely specifies that the forces of Eq. 5.3-6 should be used to calculate the shears and moments for each mode under consideration. In essence, the forces from Eq. 5.3-6 are applied to each mass, and linear static methods are used to calculate story shears and story overturning moments. The base shear that results from the calculation should agree with computed using Eq. 5.3-1.

5.3.7 Design values. This section specifies the manner in which the values of story shear, moment, and drift and the deflection at each level are to be combined. The method used, in which the design value is the square root of the sum of the squares of the modal quantities, was selected for its simplicity and its wide familiarity (Clough and Penzien, 1975; Newmark and Rosenblueth, 1971; Wiegel, 1970). In general, it gives satisfactory results, but it is not always a conservative predictor of the earthquake response inasmuch as more adverse combinations of modal quantities than are given by this method of combination can occur. The most common instance where combination by use of the square root of the sum of the squares is unconservative occurs when two modes have very nearly the same natural period. In this case, the responses are highly correlated and the designer should consider combining the modal quantities more conservatively (Newmark and Rosenblueth, 1971). The complete quadratic combination (CQC) technique provides somewhat better results than the square-root-of-the-sum-of-the-squares method for the case of closely spaced modes.

This section also limits the reduction of base shear that can be achieved by modal analysis compared to use of the ELF procedure. Some reduction, where it occurs, is thought to be justified because the modal analysis gives a somewhat more accurate representation of the earthquake response. Some limit to the reduction permitted as a result of the calculation of longer natural periods is necessary because the actual periods of vibration may not be as long, even at moderately large amplitudes of motion, due to the stiffening effects of structural elements not a part of the seismic-force-resisting system and of nonstructural components. The limit is imposed by comparison to 85 percent of the base shear value computed using the ELF procedure. Where modal analysis predicts response quantities corresponding to a total base shear less than 85 percent of that which is computed using the ELF procedure, all response results must be scaled up to that level. Where modal analysis predicts response quantities in excess of those predicted by the ELF procedure, this is likely the result of significant higher mode participation and reduction to the values obtained from the ELF procedure is not permitted.

5.3.8 Horizontal shear distribution. This section requires that the design story shears calculated in Sec. 5.3.6 and the torsional moments prescribed in Sec. 5.2.4 be distributed to the vertical elements of the seismic resisting system as specified in Sec. 5.2.4 and as elaborated on in the corresponding section of this commentary.

5.3.9 Foundation overturning. Because story moments are calculated mode by mode (properly recognizing that the direction of forces F_{xm} is controlled by the algebraic sign of f_{xm}) and then combined to obtain the design values of story moments, there is no reason for reducing these design moments. This is in contrast with reductions permitted in overturning moments calculated from equivalent lateral forces in the analysis procedures of Sec. 5.2 (see Sec. 5.2.5 of this commentary). However, in the design of the foundation, the overturning moment calculated at the foundation-soil interface may be reduced by 10 percent for the reasons mentioned in Sec. 5.2.5 of this commentary.

5.3.10 P-delta effects. Sec. 5.2.6 of this commentary applies to this section. In addition, to obtain the story drifts when using the modal analysis procedure of Sec. 5.3, the story drift for each mode should be determined independently for each story. The story drift should not be determined from the differential of combined lateral structural deflections since this latter procedure will tend to mask the higher mode effects in longer period structures.

5.4 LINEAR RESPONSE HISTORY PROCEDURE

Linear response history analysis, also commonly known as time history analysis, is a numerically involved technique in which the response of a structural model to a specific earthquake ground motion accelerogram is determined through a process of numerical integration of the equations of motion. The ground shaking accelerogram, or record, is digitized into a series of small time steps, typically on the order of 1/100th of a second or smaller. Starting at the initial time step, a finite difference solution, or other numerical integration algorithm is followed to allow the calculation of the displacements of each node in the model and the forces in each element of model for each time step of the record. For even small structural models, this requires thousands of calculations and produces tens of thousands of data points. Clearly, such a calculation procedure can be performed only with the aid of high speed computers. However, even with the use of such computers, which are now commonly available, interpretation of the voluminous data that results from such analysis is tedious.

The principal advantages of response history analysis, as opposed to response spectrum analysis, is that response history analysis provides a time dependent history of the response of the structure to a specific ground motion, allowing calculation of path dependent effects such as damping and also providing information on the stress and deformation state of the structure throughout the period of response. A response spectrum analysis, however, indicates only the maximum response quantities and does not indicate when during the period of response these occur, or how response of different portions of the structure is phased relative to that of other portions. Response history analyses are highly dependent on the characteristics of the individual ground shaking records and subtle changes in these records can lead to significant differences with regard to the predicted response of the structure. This is why, when response history analyses are used in the design process, it is necessary to run a suite of ground motion

records. The use of multiple records in the analyses allows observation of the difference in response, resulting from differences in record characteristics. As a minimum, the *Provisions* require that suites of ground motions include at least three different records. However, suites containing larger numbers of records are preferable, since when more records are run, it is more likely that the differing response possibilities for different ground motion characteristics are observed. In order to encourage the use of larger suites, the *Provisions* require that when a suite contains fewer than seven records, the maximum values of the predicted response parameters be used as the design values. When seven or more records are used, then mean values of the response parameters may be used. This can lead to a substantial reduction in design forces and displacements and typically will justify the use of larger suites of records.

Where possible, ground motion records should be scaled from actual recorded earthquake ground motions with characteristics (earthquake magnitude, distance from causative fault, and site soil conditions) similar to those which control the design earthquake for the site. Since only a limited number of actual recordings are available for such purposes, the use of synthetic records is permitted and may often be required.

The extra complexity and cost inherent in the use of response history analysis rather than modal response spectrum analysis is seldom justified. As a result this procedure is rarely used in the design process. One exception is for the design of structures with energy dissipation systems comprising linear viscous dampers. Linear response history analysis can be used to predict the response of structures with such systems, while modal response spectrum analysis cannot.

5.5 NONLINEAR RESPONSE HISTORY PROCEDURE

This method of analysis is very similar to linear response history analysis, described in Sec. 5.4, except that the mathematical model is formulated in such a way that the stiffness and even connectivity of the elements can be directly modified based on the deformation state of the structure. This permits the effects of element yielding, buckling, and other nonlinear behavior on structural response to be directly accounted for in the analysis. It also permits the evaluation of such nonlinear behaviors as foundation rocking, opening and closing of gaps, and nonlinear viscous and hysteric damping. Potentially, this ability to directly account for these various nonlinearities can permit nonlinear response history analysis to provide very accurate evaluations of the response of the structure to strong ground motion. However, this accuracy can seldom be achieved in practice. This is partially because currently available nonlinear models for different elements can only approximate the behavior of real structural elements. Another limit on the accuracy of this approach is the fact that minor deviations in ground motion, such as those described in Sec. 5.4, or even in element hysteretic behavior, can result in significant differences in predicted response. For these reasons, when nonlinear response history analysis is used in the design process, suites of ground motion time histories must be considered, as described in Sec. 5.4. It may also be appropriate to perform sensitivity studies, in which the assumed hysteretic properties of elements are allowed to vary, within expected bounds, to allow evaluation of the effects of such uncertainties on predicted response.

Application of nonlinear response history analysis to even the simplest structures requires large, high speed computers and complex computer software that has been specifically developed for this purpose. Several software packages have been in use for this purpose in universities for a number of years. These include the DRAIN family of programs and also the IDARC and IDARST family of programs. However, these programs have largely been viewed as experimental and are not generally accompanied by the same level of documentation and quality assurance typically found with commercially available software packages typically used in design offices. Although commercial software capable of performing nonlinear response history analyses has been available for several years, the use of these packages has generally been limited to complex aerospace, mechanical, and industrial applications.

As a result of this, nonlinear response history analysis has mostly been used as a research (rather than design) tool until very recently. With the increasing adoption of base isolation and energy dissipation technologies in the structural design process, however, the need to apply this analysis technique in the design office has increased, creating a demand for more commercially available software. In response to

this demand, several vendors of commercial structural analysis software have modified their analysis programs to include limited nonlinear capability including the ability to model base isolation bearings, viscous dampers, and friction dampers. Some of these programs also have a limited library of other nonlinear elements including beam and truss elements. Such software provides the design office with the ability to begin to practically implement nonlinear response history analysis on design projects.

However, such software is still limited, and it is expected that it will be some years before design offices can routinely expect to utilize this technique in the design of complex structures.

5.5.3.1 Member strength. Nonlinear response history analysis is primarily a deformation-based procedure, in which the amount of nonlinear deformation imposed on elements by response to earthquake ground shaking is predicted. As a result, when this analysis method is employed, there is no general need to evaluate the strength demand (forces) imposed on individual elements of the structure. Instead, the adequacy of the individual elements to withstand the imposed deformation demands is directly evaluated, under the requirements of Sec. 5.5.3.2. The exception to this is the requirement to evaluate brittle elements, the failure of which could result in structural collapse, for the forces predicted by the analysis. These elements are identified in the *Provisions* through the requirement that they be evaluated for earthquake forces using the seismic effects defined in Sec. 4.2.2.2. That section requires that forces predicted by elastic analysis be amplified by a factor, Ω_0 , to account in an approximate manner for the actual maximum force that can be delivered to the element, considering the inelastic behavior of the structure. Since nonlinear response history analysis does not use a response modification factor, as do elastic analysis approaches, and directly accounts for inelastic structural behavior, there is no need to further increase the forces by this factor. Instead the forces predicted by the analysis are used directly in the evaluation of the elements for adequacy under Sec. 4.2.2.2.

5.5.4 Design review. The provisions for design using linear methods of analysis including the equivalent lateral force technique of Sec. 5.2 and the modal response spectrum analysis technique of Sec. 5.3, are highly prescriptive. They limit the modeling assumptions that can be employed as well as the minimum strength and stiffness the structure must possess. Further, the methods used in linear analysis have become standardized in practice such that it is unlikely that different designers using the same technique to analyze the same structure will produce substantially different results. However, when nonlinear analytical methods are employed to predict the structure's strength and its deformation under load, many of these prescriptive provisions are no longer applicable. Further, as these methods are currently not widely employed by the profession, the standardization that has occurred for linear methods of analysis has not yet been developed for these techniques. As a result analysis has not yet been developed for these techniques, and the designer using such methods must employ a significant amount of independent judgment in developing appropriate analytical models, performing the analysis, and interpreting the results to confirm the adequacy of a design. Since relatively minor changes in the assumptions used in performing a nonlinear structural analysis can significantly affect the results obtained from such an analysis, it is imperative that the assumptions used be appropriate. The *Provisions* require that designs employing nonlinear analysis methods be subjected to independent design review in order to provide a level of assurance that the independent judgment applied by the designer when using these methods is appropriate and compatible with that which would be made by other competent practitioners.

5.6 SOIL-STRUCTURE INTERACTION EFFECTS

5.6.1 General

Statement of the problem. Fundamental to the design requirements presented in Sec. 5.2 and 5.3 is the assumption that the motion experienced by the base of a structure during an earthquake is the same as the "free-field" ground motion, a term that refers to the motion that would occur at the level of the foundation

if no structure was present. This assumption implies that the foundation-soil system underlying the structure is rigid and, hence, represents a “fixed-base” condition. Strictly speaking, this assumption never holds in practice. For structures supported on a deformable soil, the foundation motion generally is different from the free-field motion and may include an important rocking component in addition to a lateral or translational component. The rocking component, and soil-structure interaction effects in general, tend to be most significant for laterally stiff structures such as buildings with shear walls, particularly those located on soft soils. For convenience, in what follows the response of a structure supported on a deformable foundation-soil system will be denoted as the “flexible-base” response.

A flexibly supported structure also differs from a rigidly supported structure in that a substantial part of its vibrational energy may be dissipated into the supporting medium by radiation of waves and by hysteretic action in the soil. The importance of the latter factor increases with increasing intensity of ground-shaking. There is, of course, no counterpart of this effect of energy dissipation in a rigidly supported structure.

The effects of soil-structure interaction accounted for in Sec. 5.6 represent the difference in the flexible-base and fixed-base responses of the structure. This difference depends on the properties of the structure and the supporting medium as well as the characteristics of the free-field ground motion.

The interaction effects accounted for in Sec. 5.6 should not be confused with “site effects,” which refer to the fact that the characteristics of the free-field ground motion induced by a dynamic event at a given site are functions of the properties and geological features of the subsurface soil and rock. The interaction effects, on the other hand, refer to the fact that the dynamic response of a structure built on that site depends, in addition, on the interrelationship of the structural characteristics and the properties of the local underlying soil deposits. The site effects are reflected in the values of the seismic coefficients employed in Sec. 5.2 and 5.3 and are accounted for only implicitly in Sec. 5.6.

Possible approaches to the problem. Two different approaches may be used to assess the effects of soil-structure interaction. The first involves modifying the stipulated free-field design ground motion, evaluating the response of the given structure to the modified motion of the foundation, and solving simultaneously with additional equations that define the motion of the coupled system, whereas the second involves modifying the dynamic properties of the structure and evaluating the response of the modified structure to the prescribed free-field ground motion (Jennings and Bielak, 1973; Veletsos, 1977). When properly implemented, both approaches lead to equivalent results. However, the second approach, involving the use of the free-field ground motion, is more convenient for design purposes and provides the basis of the requirements presented in Sec. 5.6.

Characteristics of interaction. The interaction effects in the approach used here are expressed by an increase in the fundamental natural period of the structure and a change (usually an increase) in its effective damping.

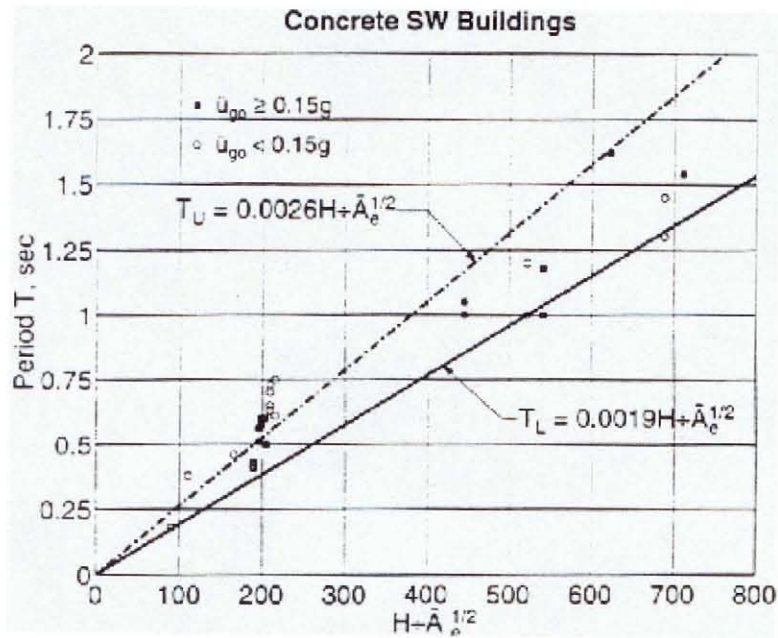

Figure C5.2-3 Measured building period for concrete shear wall structures.

The increase in period results from the flexibility of the foundation soil whereas the change in damping results mainly from the effects of energy dissipation in the soil due to radiation and material damping.

These statements can be clarified by comparing the responses of rigidly and elastically supported systems subjected to a harmonic excitation of the base.

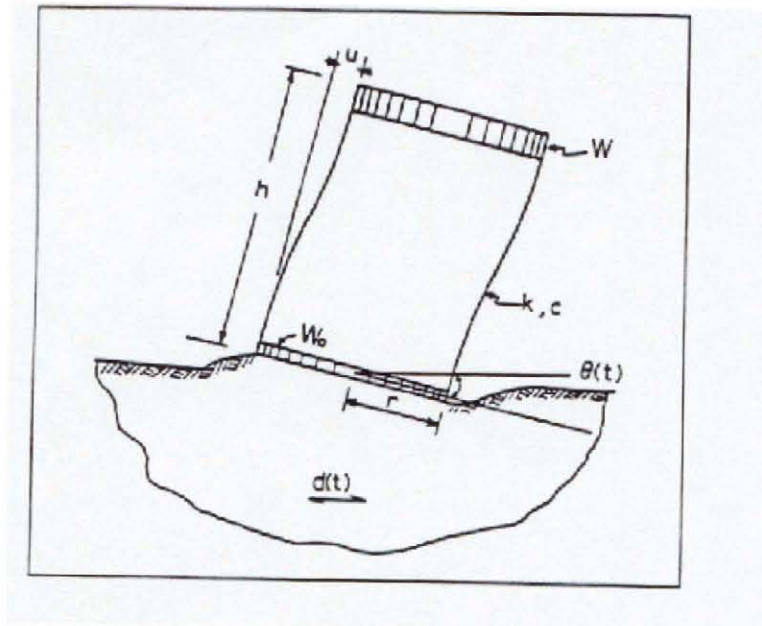

Figure C5.6-1 Simple system investigated.

Consider a linear structure of weight W , lateral stiffness k , and coefficient of viscous damping c (shown in Figure C5.6-1) and assume that it is supported by a foundation of weight W_o at the surface of a homogeneous, elastic halfspace.

The foundation mat is idealized as a rigid circular plate of negligible thickness bonded to the supporting medium, and the columns of the structure are considered to be weightless and axially inextensible. Both the foundation weight and the weight of the structure are assumed to be uniformly distributed over circular areas of radius r . The base excitation is specified by the free-field motion of the ground surface. This is taken as a horizontally directed, simple harmonic motion with a period T_o and an acceleration amplitude a_m .

The configuration of this system, which has three degrees of freedom when flexibly supported and a single degree of freedom when fixed at the base, is specified by the lateral displacement and rotation of the foundation, y and θ , and by the displacement of the top of the structure, u , relative to its base. The system may be viewed either as the direct model of a one-story structural frame or, more generally, as a model of a multistory, multimode structure that responds as a single-degree-of-freedom system in its fixed-base condition. In the latter case, h must be interpreted as the distance from the base to the centroid of the inertia forces associated with the fundamental mode of vibration of the fixed-base structure and W , k , and c must be interpreted as its generalized or effective weight, stiffness, and damping coefficient, respectively. The relevant expressions for these quantities are given below.

The solid lines in Figures C5.6-2 and C5.6-3 represent response spectra for the steady-state amplitude of the total shear in the columns of the system considered in Figure C5.6-1. Two different values of h/r and several different values of the relative flexibility parameter for the soil and the structure, ϕ_o , are

considered. The latter parameter is defined by the equation $\delta_o = \frac{h}{v_s T}$ in which h is the height of the

structure as previously indicated, v_s is the velocity of shear wave propagation in the halfspace, and T is the fixed-base natural period of the structure. A value of $\phi = 0$ corresponds to a rigidly supported structure.

The results in Figures C5.6-2 and C5.6-3 are displayed in a dimensionless form, with the abscissa representing the ratio of the period of the excitation, T_o , to the fixed-base natural period of the system, T , and the ordinate representing the ratio of the amplitude of the actual base shear, V , to the amplitude of the base shear induced in an infinitely stiff, rigidly supported structure.

The latter quantity is given by the product ma_m , in which $m = W/g$, g is the acceleration due to gravity, and a_m is the acceleration amplitude of the free-field ground motion. The inclined scales on the left represent the deformation amplitude of the superstructure, u , normalized with respect to the displacement

amplitude of the free-field ground motion $d_m = \frac{a_m T_o^2}{4\pi^2}$.

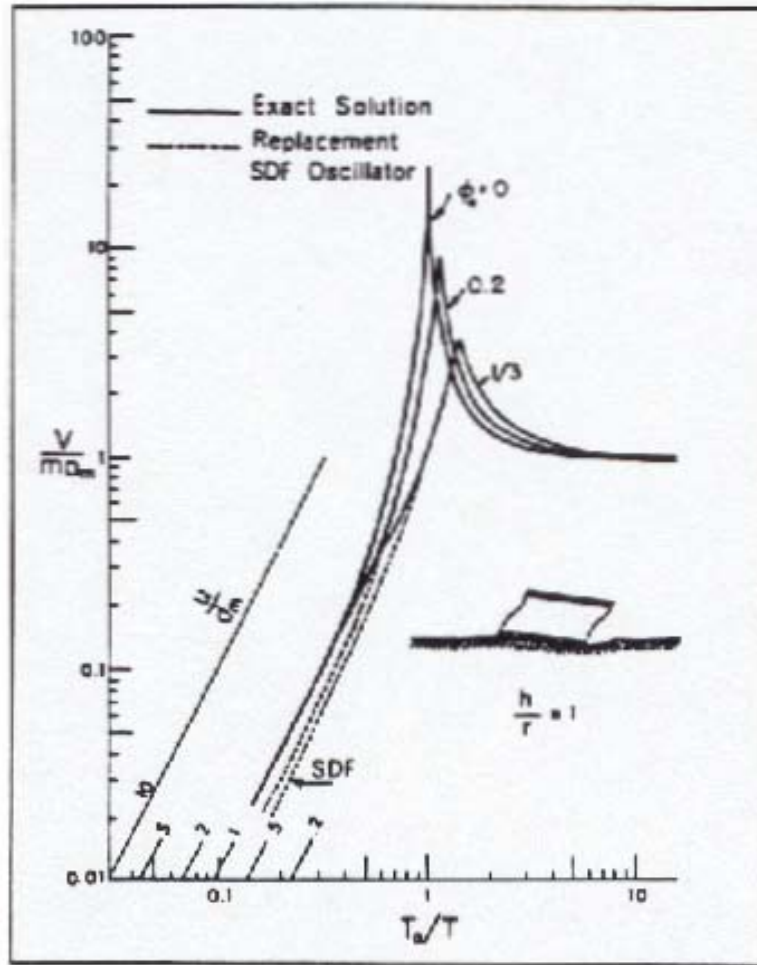

Figure C5.6-2 Response spectra for systems with $h/r = 1$ (Veletsos and Meek, 1974).

The damping of the structure in its fixed-base condition, β , is considered to be 2 percent of the critical value, and the additional parameters needed to characterize completely these solutions are identified in Veletsos and Meek (1974), from which these figures have been reproduced.

Comparison of the results presented in these figures reveals that the effects of soil-structure interaction are most strikingly reflected in a shift of the peak of the response spectrum to the right and a change in the magnitude of the peak. These changes, which are particularly prominent for taller structures and more flexible soils (increasing values of ϕ_0), can conveniently be expressed by an increase in the natural period of the system over its fixed-base value and by a change in its damping factor.

Also shown in these figures in dotted lines are response spectra for single-degree-of-freedom (SDF) oscillators, the natural period and damping of which have been adjusted so that the absolute maximum (resonant) value of the base shear and the associated period are in each case identical to those of the actual interacting systems. The base motion for the replacement oscillator is considered to be the same as the free-field ground motion. With the properties of the replacement SDF oscillator determined in this manner, it is important to note that the response spectra for the actual and the replacement systems are in excellent agreement over wide ranges of the exciting period on both sides of the resonant peak.

In the context of Fourier analysis, an earthquake motion may be viewed as the result of superposition of harmonic motions of different periods and amplitudes. Inasmuch as the components of the excitation with periods close to the resonant period are likely to be the dominant contributors to the response, the maximum responses of the actual system and of the replacement oscillator can be expected to be in satisfactory agreement for earthquake ground motions as well. This expectation has been confirmed by the results of comprehensive comparative studies (Veletsos, 1977; Veletsos and Meek, 1974; Veletsos and Nair, 1975; Jennings and Bielak, 1973).

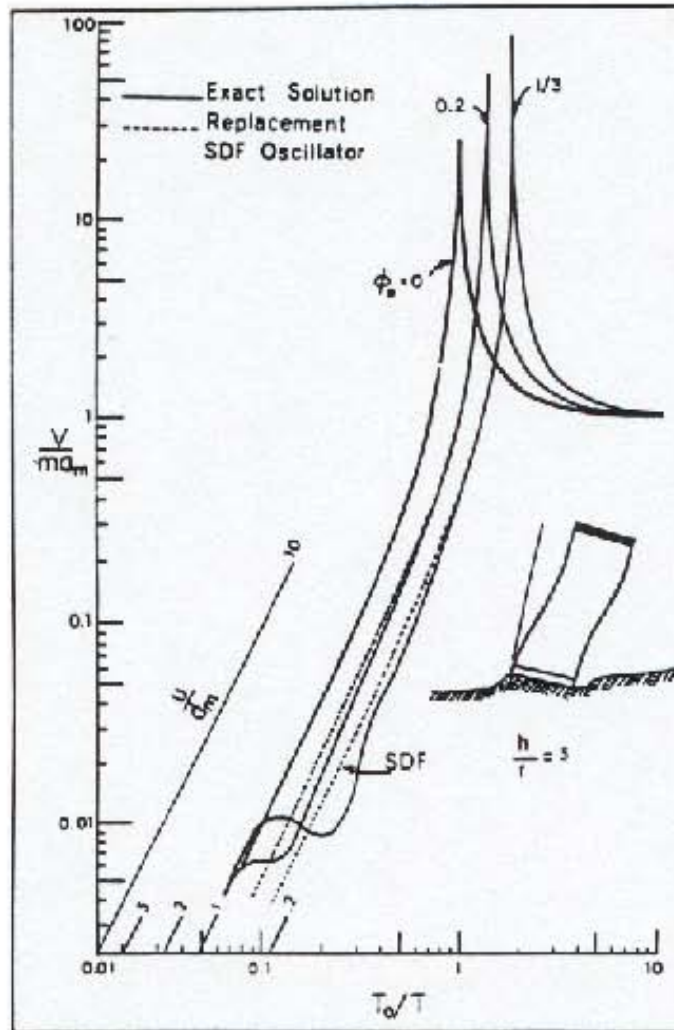

Figure C5.6-3 Response spectra for systems with $h/r = 5$ (Veletsos and Meek, 1974).

It follows that, to the degree of approximation involved in the representation of the actual system by the replacement SDF oscillator, the effects of interaction on maximum response may be expressed by an increase in the fundamental natural period of the fixed-base system and by a change in its damping value. In the following sections, the natural period of replacement oscillator is denoted by \tilde{T} and the associated damping factor by $\tilde{\beta}$. These quantities will also be referred to as the effective natural period and the effective damping factor of the interacting system. The relationships between \tilde{T} and T and between $\tilde{\beta}$ and β are considered in Sec. 5.6.2.1.1 and 5.6.2.1.2.

Basis of provisions and assumptions. Current knowledge of the effects of soil-structure interactions is derived mainly from studies of systems of the type referred to above in which the foundation is idealized as a rigid mat. For foundations of this type, both surface-supported and embedded structures resting on uniform as well as layered soil deposits have been investigated (Bielak, 1975; Chopra and Gutierrez, 1974; Jennings and Bielak, 1973; Liu and Fagel, 1971; Parmelee et al., 1969; Roesset et al., 1973; Veletsos, 1977; Veletsos and Meek, 1974; Veletsos and Nair, 1975). However, the results of such studies may be of limited applicability for foundation systems consisting of individual spread footings or deep foundations (piles or drilled shafts) not interconnected with grade beams or a mat. The requirements presented in Sec. 5.6 for the latter cases represent the best interpretation and judgment of the developers of the requirements regarding the current state of knowledge.

Fundamental to these requirements is the assumption that the structure and the underlying soil are bonded and remain so throughout the period of ground-shaking. It is further assumed that there is no soil instability or large foundation settlements. The design of the foundation in a manner to ensure satisfactory soil performance (for example, to avoid soil instability and settlement associated with the compaction and liquefaction of loose granular soils), is beyond the scope of Sec. 5.6. Finally, no account is taken of the interaction effects among neighboring structures.

Nature of interaction effects. Depending on the characteristics of the structure and the ground motion under consideration, soil-structure interaction may increase, decrease, or have no effect on the magnitudes of the maximum forces induced in the structure itself (Bielak, 1975; Jennings and Bielak, 1973; Veletsos, 1977; Veletsos and Meek, 1974; Veletsos and Nair, 1975). However, for the conditions stipulated in the development of the requirements for rigidly supported structures presented in Sec. 5.2 and 5.3, soil-structure interaction will reduce the design values of the base shear and moment from the levels applicable to a fixed-base condition. These forces therefore can be evaluated conservatively without the adjustments recommended in Sec. 5.6.

Because of the influence of foundation rocking, however, the horizontal displacements relative to the base of the elastically supported structure may be larger than those of the corresponding fixed-base structure, and this may increase both the required spacing between structures and the secondary design forces associated with the P -delta effects. Such increases generally are small for frame structures, but can be significant for shear wall structures.

Scope. Two procedures are used to incorporate effects of the soil-structure interaction. The first is an extension of the equivalent lateral force procedure presented in Sec. 5.2 and involves the use of equivalent lateral static forces. The second is an extension of the simplified modal analysis procedure presented in Sec. 5.3. In the latter approach, the earthquake-induced effects are expressed as a linear combination of terms, the number of which is equal to the number of stories involved. Other more complex procedures also may be used, and these are outlined briefly at the end of this commentary on Sec. 5.6. However, it is believed that the more involved procedures are justified only for unusual structures and when the results of the specified simpler approaches have revealed that the interaction effects are indeed of definite consequence in the design.

5.6.2 Equivalent lateral force procedure. This procedure is similar to that used in the older SEAOC recommendations except that it incorporates several improvements (see Sec. 5.2 of this commentary). In effect, the procedure considers the response of the structure in its fundamental mode of vibration and accounts for the contributions of the higher modes implicitly through the choice of the effective weight of the structure and the vertical distribution of the lateral forces. The effects of soil-structure interaction are accounted for on the assumption that they influence only the contribution of the fundamental mode of vibration. For structures, this assumption has been found to be adequate (Bielak, 1976; Jennings and Bielak, 1973; Veletsos, 1977).

5.6.2.1 Base shear. With the effects of soil-structure interaction neglected, the base shear is defined by Eq. 5.2-1, $V = C_s W$, in which W is the total seismic weight (as specified in Sec. 5.2.1) and C_s is the dimensionless seismic response coefficient (as defined in Sec. 5.2.1.1). This term depends on the level of seismic hazard under consideration, the properties of the site, and the characteristics of the structure itself.

The latter characteristics include the rigidly supported fundamental natural period of the structure, T , the associated damping factor, β , and the degree of permissible inelastic deformation. The damping factor does not appear explicitly in Sec. 5.2.1.1 because a constant value of $\beta = 0.05$ has been used for all structures for which the interaction effects are negligible. The degree of permissible inelastic action is reflected in the choice of the reduction factor, R . It is convenient to rewrite Eq. 5.2-1 in the form:

$$V = C_s(T, \beta)\bar{W} + C_s(T, \beta)[W - \bar{W}] \quad (\text{C5.6-1})$$

where \bar{W} represents the generalized or effective weight of the structure when vibrating in its fundamental natural mode. The terms in parentheses are used to emphasize the fact that C_s depends upon both T and β . The relationship between \bar{W} and W is given below. The first term on the right side of Eq. C5.6-1 approximates the contribution of the fundamental mode of vibration whereas the second term approximates the contributions of the higher natural modes. Inasmuch as soil-structure interaction may be considered to affect only the contribution of the fundamental mode and inasmuch as this effect can be expressed by changes in the fundamental natural period and the associated damping of the system, the base shear for the interacting system, \tilde{V} , may be stated (in a form analogous to Eq. C5.6-1) as follows:

$$\tilde{V} = C_s(\tilde{T}, \tilde{\beta})\bar{W} + C_s(T, \beta)[W - \bar{W}] \quad (\text{C5.6-2})$$

The value of C_s in the first part of this equation should be evaluated for the natural period and damping of the elastically supported system, \tilde{T} and $\tilde{\beta}$, respectively, and the value of C_s in the second term part should be evaluated for the corresponding quantities of the rigidly supported system, T and β .

Before proceeding with the evaluation of the coefficients C_s in Eq. C5.6-2, it is desirable to rewrite this formula in the same form as Eq. 5.6-1. Making use of Eq. 5.2-1 and rearranging terms, the following expression for the reduction in the base shear is obtained:

$$\Delta V = [C_s(T, \beta) - C_s(\tilde{T}, \tilde{\beta})]\bar{W} \quad (\text{C5.6-3})$$

Within the ranges of natural period and damping that are of interest in studies of structural response, the values of C_s corresponding to two different damping values but the same natural period (T), are related approximately as follows:

$$C_s(\tilde{T}, \tilde{\beta}) = C_s(\tilde{T}, \beta) \left(\frac{\beta}{\tilde{\beta}} \right)^{0.4} \quad (\text{C5.6-4})$$

This expression, which appears to have been first proposed in Arias and Husid (1962), is in good agreement with the results of studies of earthquake response spectra for systems having different damping values (Newmark et al., 1973).

Substitution of Eq. C5.6-4 in Eq. C5.6-3 leads to:

$$\Delta V = \left[C_s(T, \beta) - C_s(\tilde{T}, \beta) \left(\frac{\beta}{\tilde{\beta}} \right)^{0.4} \right] \bar{W} \quad (\text{C5.6-5})$$

where both values of C_s are now for the damping factor of the rigidly supported system and may be evaluated from Eq. 5.2-2 and 5.2-3. If the terms corresponding to the periods T and \tilde{T} are denoted more simply as C_s and \tilde{C}_s , respectively, and if the damping factor β is taken as 0.05, Eq. C5.6-5 reduces to Eq. 5.6-2.

Note that \tilde{C}_s in Eq. 5.6-2 is smaller than or equal to C_s because Eq. 5.2-3 is a nonincreasing function of the natural period and \tilde{T} is greater than or equal to T . Furthermore, since the minimum value of $\tilde{\beta}$ is taken as $\tilde{\beta} = \beta = 0.05$ (see statement following Eq. 5.6-10), the shear reduction ΔV is a non-negative

quantity. It follows that the design value of the base shear for the elastically supported structure cannot be greater than that for the associated rigid-base structure.

The effective weight of the structure, \bar{W} , is defined by Eq. 5.3-2, in which ϕ_{im} should be interpreted as the displacement amplitude of the i^{th} floor when the structure is vibrating in its fixed-base fundamental natural mode. It should be clear that the ratio \bar{W}/W depends on the detailed characteristics of the structure. A constant value of $\bar{W} = 0.7 W$ is recommended in the interest of simplicity and because it is a good approximation for typical structures. As an example, it is noted that for a tall structure for which the weight is uniformly distributed along the height and for which the fundamental natural mode increases linearly from the base to the top, the exact value of $\bar{W} = 0.7 W$. Naturally, when the full weight of the structure is concentrated at a single level, \bar{W} should be taken equal to W .

The maximum permissible reduction in base shear due to the effects of soil-structure interaction is set at 30 percent of the value calculated for a rigid-base condition. It is expected, however, that this limit will control only infrequently and that the calculated reduction, in most cases, will be less.

5.6.2.1.1 Effective building period. Equation 5.6-3 for the effective natural period of the elastically supported structure, \tilde{T} , is determined from analyses in which the superstructure is presumed to respond in its fixed-base fundamental mode and the foundation weight is considered to be negligible in comparison to the weight of the superstructure (Jennings and Bielak, 1973; Veletsos and Meeek, 1974). The first term under the radical represents the period of the fixed-base structure. The first portion of the second term represents the contribution to \tilde{T} of the translational flexibility of the foundation, and the last portion represents the contribution of the corresponding rocking flexibility. The quantities \bar{k} and \bar{h} represent, respectively, the effective stiffness and effective height of the structure, and K_y and K_θ represent the translational and rocking stiffnesses of the foundation.

Equation 5.6-4 for the structural stiffness, \bar{k} , is deduced from the well known expression for the natural period of the fixed-base system:

$$T = 2\pi \sqrt{\left(\frac{1}{g}\right) \left(\frac{\bar{W}}{\bar{k}}\right)} \quad (\text{C5.6-6})$$

The effective height, \bar{h} , is defined by Eq. 5.6-13, in which ϕ_{i1} has the same meaning as the quantity ϕ_{im} in Eq. 5.3-2 when $m = 1$. In the interest of simplicity and consistency with the approximation used in the definition of \bar{W} , however, a constant value of $\bar{h} = 0.7h_n$ is recommended where h_n is the total height of the structure. This value represents a good approximation for typical structures. As an example, it is noted that for tall structures for which the fundamental natural mode increases linearly with height, the exact value of \bar{h} is $2/3h_n$. Naturally, when the gravity load of the structure is effectively concentrated at a single level, h_n must be taken as equal to the distance from the base to the level of weight concentration.

Foundation stiffnesses depend on the geometry of the foundation-soil contact area, the properties of the soil beneath the foundation, and the characteristics of the foundation motion. Most of the available information on this subject is derived from analytical studies of the response of harmonically excited rigid circular foundations, and it is desirable to begin with a brief review of these results.

For circular mat foundations supported at the surface of a homogeneous halfspace, stiffnesses K_y and K_θ are given by:

$$K_y = \left[\frac{8\alpha_y}{2-\nu} \right] Gr \quad (\text{C5.6-7})$$

and

$$K_{\theta} = \left[\frac{8\alpha_{\theta}}{3(1-\nu)} \right] Gr^3 \quad (C5.6-8)$$

where r is the radius of the foundation; G is the shear modulus of the halfspace; ν is its Poisson's ratio; and α_y and α_{θ} are dimensionless coefficients that depend on the period of the excitation, the dimensions of the foundation, and the properties of the supporting medium (Luco, 1974; Veletsos and Verbic, 1974; Veletsos and Wei, 1971). The shear modulus is related to the shear wave velocity, v_s , by the formula:

$$G = \frac{\gamma v_s^2}{g} \quad (C5.6-9)$$

in which γ is the unit weight of the material. The values of G , v_s , and ν should be interpreted as average values for the region of the soil that is affected by the forces acting on the foundation and should correspond to the conditions developed during the design earthquake. The evaluation of these quantities is considered further in subsequent sections. For statically loaded foundations, the stiffness coefficients α_y and α_{θ} are unity, and Eq. C5.6-7 and C5.6-8 reduce to:

$$K_y = \frac{8Gr}{2-\nu} \quad (C5.6-10)$$

and

$$K_{\theta} = \frac{8Gr^3}{3(1-\nu)} \quad (C5.6-11)$$

Studies of the interaction effects in structure-soil systems have shown that, within the ranges of parameters of interest for structures subjected to earthquakes, the results are insensitive to the period-dependency of α_y and that it is sufficiently accurate for practical purposes to use the static stiffness K_y , defined by Eq. C5.6-10. However, the dynamic modifier for rocking α_{θ} can significantly affect the response of building structures. In the absence of more detailed analyses, for ordinary building structures with an embedment ratio $d/r < 0.5$, the factor α_{θ} can be estimated as follows:

$R/v_s T$	α_{θ}
<0.05	1.0
0.15	0.85
0.35	0.7
0.5	0.6

where d equals depth of embedment and r can be taken as r_m defined in Eq. 5.6-8.

The above values were derived from the solution for α_{θ} by Veletsos and Verbic (1973). In this solution α_{θ} is a function of \tilde{T} . To relate α_{θ} to T , a correction for period lengthening (\tilde{T}/T) was made assuming $\bar{h}/r \square 0.5$ to 1.0 and Poisson's ratio $\nu = 0.4$.

Foundation embedment has the effect of increasing the stiffnesses K_y and K_{θ} . For embedded foundations for which there is positive contact between the side walls and the surrounding soil, K_y and K_{θ} may be determined from the following approximate formulas:

$$K_y = \left[\frac{8Gr}{2-\nu} \right] \left[1 + \left(\frac{2}{3} \right) \left(\frac{d}{r} \right) \right] \quad (C5.6-12)$$

and

$$K_{\theta} = \left[\frac{8Gr^3\alpha_{\theta}}{3(1-\nu)} \right] \left[1 + 2\left(\frac{d}{r}\right) \right] \quad (\text{C5.6-13})$$

in which d is the depth of embedment. These formulas are based on finite element solutions (Kausel, 1974).

Both analyses and available test data (Erden, 1974) indicate that the effects of foundation embedment are sensitive to the condition of the backfill and that judgment must be exercised in using Eq. C5.6-12 and C5.6-13. For example, if a structure is embedded in such a way that there is no positive contact between the soil and the walls of the structure, or when any existing contact cannot reasonably be expected to remain effective during the stipulated design ground motion, stiffnesses K_y and K_{θ} should be determined from the formulas for surface-supported foundations. More generally, the quantity d in Eq. C5.6-12 and C5.6-13 should be interpreted as the effective depth of foundation embedment for the conditions that would prevail during the design earthquake.

The formulas for K_y and K_{θ} presented above are strictly valid only for foundations supported on reasonably uniform soil deposits. When the foundation rests on a surface stratum of soil underlain by a stiffer deposit with a shear wave velocity (v_s) more than twice that of the surface layer (Wallace et al., 1999), K_y and K_{θ} may be determined from the following two generalized formulas in which G is the shear modulus of the soft soil and D_s is the total depth of the stratum. First, using Eq. C5.6-12:

$$K_y = \left[\frac{8Gr}{2-\nu} \right] \left[1 + \left(\frac{2}{3}\right)\left(\frac{d}{r}\right) \right] \left[1 + \left(\frac{1}{2}\right)\left(\frac{r}{D_s}\right) \right] \left[1 + \left(\frac{5}{4}\right)\left(\frac{d}{D_s}\right) \right] \quad (\text{C5.6-14})$$

Second, using Eq. C5.6-13:

$$K_{\theta} = \left[\frac{8Gr^3\alpha_{\theta}}{3(1-\nu)} \right] \left[1 + 2\left(\frac{d}{r}\right) \right] \left[1 + \left(\frac{1}{6}\right)\left(\frac{r}{D_s}\right) \right] \left[1 + 0.7\left(\frac{d}{D_s}\right) \right] \quad (\text{C5.6-15})$$

These formulas are based on analyses of a stratum supported on a rigid base (Elsabee et al., 1977; Kausel and Roesset, 1975) and apply for $r/D_s < 0.5$ and $d/r < 1$.

The information for circular foundations presented above may be applied to mat foundations of arbitrary shapes provided the following changes are made:

1. The radius r in the expressions for K_y is replaced by r_a (Eq. 5.6-7), which represents the radius of a disk that has the area, A_o , of the actual foundation.
2. The radius r in the expressions for K_{θ} is replaced by r_m (Eq. 5.6-8), which represents the radius of a disk that has the moment of inertia, I_o , of the actual foundation.

For footing foundations, stiffnesses K_y and K_{θ} are computed by summing the contributions of the individual footings. If it is assumed that the foundation behaves as a rigid body and that the individual footings are widely spaced so that they act as independent units, the following formulas are obtained:

$$K_y = \Sigma k_{yi} \quad (\text{C5.6-16})$$

and

$$K_{\theta} = \Sigma k_{xi} y_i^2 + \Sigma k_{\theta i} \quad (\text{C5.6-17})$$

The quantity k_{yi} represents the horizontal stiffness of the i^{th} footing; k_{xi} and $k_{\theta i}$ represent, respectively, the corresponding vertical and rocking stiffnesses; and y_i represents the normal distance from the centroid of the i^{th} footing to the rocking axis of the foundation. The summations are considered to extend over all footings. The contribution to K_{θ} of the rocking stiffnesses of the individual footings, $k_{\theta i}$, generally is small and may be neglected.

The stiffnesses k_{yi} , k_{xi} , and $k_{\theta i}$ are defined by the formulas:

$$k_{yi} = \left(\frac{8G_i r_{ai}}{2 - \nu} \right) \left(1 + \frac{2d}{3r} \right) \quad (\text{C5.6-18})$$

$$k_{yi} = \left(\frac{4G_i r_{ai}}{1 - \nu} \right) \left(1 + 0.4 \frac{d}{r} \right) \quad (\text{C5.6-19})$$

and

$$k_{\theta i} = \left(\frac{8G_i r_{mi}^3}{3(1 - \nu)} \right) \left(1 + 2 \frac{d}{r} \right) \quad (\text{C5.6-20})$$

in which d_i is the depth of effective embedment for the i^{th} footing; G_i is the shear modulus of the soil beneath the i^{th} footing; $r_{ai} = \sqrt{A_{oi} / \pi}$ is the radius of a circular footing that has the area of the i^{th} footing, A_{oi} ; and r_{mi} equals $\sqrt[4]{4I_{oi} / \pi}$ the radius of a circular footing, the moment of inertia of which about a horizontal centroidal axis is equal to that of the i^{th} footing, I_{oi} , in the direction in which the response is being evaluated.

For surface-supported footings and for embedded footings for which the side wall contact with the soil cannot be considered to be effective during the stipulated design ground motion, d_i in these formulas should be taken as zero. Furthermore, the values of G_i should be consistent with the stress levels expected under the footings and should be evaluated with due regard for the effects of the dead loads involved. This matter is considered further in subsequent sections. For closely spaced footings, consideration of the coupling effects among footings will reduce the computed value of the overall foundation stiffness. This reduction, in turn, will increase the fundamental natural period of the system, \tilde{T} , and increase the value of ΔV , the amount by which the base shear is reduced due to soil-structure interaction. It follows that the use of Eq. C5.6-16 and 5.6-17 will err on the conservative side in this case. The degree of conservatism involved, however, will partly be compensated by the presence of a basement slab that, even when it is not tied to the structural frame, will increase the overall stiffness of the foundation.

The values of K_y and K_θ for pile foundations can be computed in a manner analogous to that described in the preceding section by evaluating the horizontal, vertical, and rocking stiffnesses of the individual piles, k_{yi} , k_{xi} , and $k_{\theta i}$, and by combining these stiffnesses in accordance with Eq. C5.6-16 and C5.6-17.

The individual pile stiffnesses may be determined from field tests or analytically by treating each pile as a beam on an elastic subgrade. Numerous formulas are available in the literature (Tomlinson, 1994) that express these stiffnesses in terms of the modulus of the subgrade reaction and the properties of the pile itself. These stiffnesses sometimes are expressed in terms of the stiffness of an equivalent freestanding cantilever, the physical properties and cross-sectional dimensions of which are the same as those of the actual pile but the length of which is adjusted appropriately. The effective lengths of the equivalent cantilevers for horizontal motion and for rocking or bending motion are slightly different but are often assumed to be equal. On the other hand, the effective length in vertical motion is generally considerably greater.

The soil properties of interest are the shear modulus, G , or the associated shear wave velocity, v_s ; the unit weight, γ ; and Poisson's ratio, ν . These quantities are likely to vary from point to point of a construction site, and it is necessary to use average values for the soil region that is affected by the forces acting on the foundation. The depth of significant influence is a function of the dimensions of the foundation base and of the direction of the motion involved. The effective depth may be considered to extend to about $0.75r_a$ below the foundation base for horizontal motions, $2r_a$ for vertical motions, and to about $0.75r_m$ for rocking motion. For mat foundations, the effective depth is related to the total plan dimensions of the mat whereas for structures supported on widely spaced spread footings, it is related to the dimensions of the individual footings. For closely spaced footings, the effective depth may be determined by superposition of the "pressure bulbs" induced by the forces acting on the individual footings.

Since the stress-strain relations for soils are nonlinear, the values of G and v_s also are functions of the strain levels involved. In the formulas presented above, G should be interpreted as the secant shear modulus corresponding to the significant strain level in the affected region of the foundation soil. The approximate relationship of this modulus to the modulus G_o corresponding to small amplitude strains (of the order of 10^{-3} percent or less) is given in Table 5.6-1. The backgrounds of this relationship and of the corresponding relationship for v_s/v_{so} are identified below.

The low amplitude value of the shear modulus, G_o , can most conveniently be determined from the associated value of the shear wave velocity, v_{so} , by use of Eq. C5.6-9. The latter value may be determined approximately from empirical relations or more accurately by means of field tests or laboratory tests.

The quantities G_o and v_{so} depend on a large number of factors (Hardin, 1978), the most important of which are the void ratio, e , and the average confining pressure, $\bar{\sigma}_o$. The value of the latter pressure at a given depth beneath a particular foundation may be expressed as the sum of two terms as follows:

$$\bar{\sigma}_o = \bar{\sigma}_{os} + \bar{\sigma}_{ob} \quad (C5.6-21)$$

in which $\bar{\sigma}_{os}$ represents the contribution of the weight of the soil and $\bar{\sigma}_{ob}$ represents the contribution of the superimposed weight of the structure and foundation. The first term is defined by the formula:

$$\bar{\sigma}_{os} = \left(\frac{1 + 2K_o}{3} \right) \gamma' x \quad (C5.6-22)$$

in which x is the depth of the soil below the ground surface, γ' is the average effective unit weight of the soil to the depth under consideration, and K_o is the coefficient of horizontal earth pressure at rest. For sands and gravel, K_o has a value of 0.5 to 0.6 whereas for soft clays, $K_o \approx 1.0$. The pressures $\bar{\sigma}_{ob}$ developed by the weight of the structure can be estimated from the theory of elasticity (Poulos and Davis, 1974). In contrast to $\bar{\sigma}_{os}$ which increases linearly with depth, the pressures $\bar{\sigma}_{ob}$ decrease with depth. As already noted, the value of v_{so} should correspond to the average value of $\bar{\sigma}_o$ in the region of the soil that is affected by the forces acting on the foundation.

For clean sands and gravels having $e < 0.80$, the low-amplitude shear wave velocity can be calculated approximately from the formula:

$$v_{so} = c_1 (2.17 - e) (\bar{\sigma})^{0.25} \quad (C5.6-23)$$

in which c_1 equals 78.2 when $\bar{\sigma}$ is in lb/ft^2 and v_{so} is in ft/sec ; c_1 equals 160.4 when $\bar{\sigma}$ is in kg/cm^2 and v_{so} is in m/sec ; and c_1 equals 51.0 when $\bar{\sigma}$ is in kN/m^2 and v_{so} is in m/sec .

For angular-grained cohesionless soils ($e > 0.6$), the following empirical equation may be used:

$$v_{so} = c_2 (2.97 - e) (\bar{\sigma})^{0.25} \quad (C5.6-24)$$

in which c_2 equals 53.2 when $\bar{\sigma}$ is in lb/ft^2 and v_{so} is in ft/sec ; c_2 equals 109.7 when $\bar{\sigma}$ is in kg/cm^2 and v_{so} is in m/sec ; and c_2 equals 34.9 when $\bar{\sigma}$ is in kN/m^2 and v_{so} is in m/sec .

Equation C5.6-24 also may be used to obtain a first-order estimate of v_{so} for normally consolidated cohesive soils. A crude estimate of the shear modulus, G_o , for such soils may also be obtained from the relationship:

$$G_o = 1,000 s_u \quad (C5.6-25)$$

in which s_u is the shearing strength of the soil as developed in an unconfined compression test. The coefficient 1,000 represents a typical value, which varied from 250 to about 2,500 for tests on different soils (Hara et al., 1974; Hardin and Drnevich, 1975).

These empirical relations may be used to obtain preliminary, order-of-magnitude estimates. For more accurate evaluations, field measurements of v_{so} should be made. Field evaluations of the variations of v_{so}

throughout the construction site can be carried out by standard seismic refraction methods, the downhole or cross-hole methods, suspension logging, or spectral analysis with surface waves. Kramer (1996) provides an overview of these testing procedures. The disadvantage of these methods is that v_{so} is determined only for the stress conditions existing at the time of the test (usually $\bar{\sigma}_{so}$). The effect of the changes in the stress conditions caused by construction must be considered by use of Eq. C5.6-22, C5.6-23, and C5.6-24 to adjust the field measurement of v_{so} to correspond to the prototype situations. The influence of large-amplitude shearing strains may be evaluated from laboratory tests or approximated through the use of Table 5.6-1. This matter is considered further in the next two sections.

An increase in the shearing strain amplitude is associated with a reduction in the secant shear modulus, G , and the corresponding value of v_s . Extensive laboratory tests (for example, Vucetic and Dobry, 1991; Seed et al., 1984) have established the magnitudes of the reductions in v_s for both sands and clays as the shearing strain amplitude increases.

The results of such tests form the basis for the information presented in Table 5.6-1. For each severity of anticipated ground-shaking, represented by the effective peak acceleration coefficients (taken as $0.4S_{DS}$) a representative value of shearing strain amplitude was developed. A conservative value of v_s/v_{so} that is appropriate to that strain amplitude then was established. It should be emphasized that the values in Table 5.6-1 are first order approximations. More precise evaluations would require the use of material-specific shear modulus reduction curves and studies of wave propagation for the site to determine the magnitude of the soil strains induced.

It is satisfactory to assume Poisson's ratio for soils as: $\nu = 0.33$ for clean sands and gravels, $\nu = 0.40$ for stiff clays and cohesive soils, and $\nu = 0.45$ for soft clays. The use of an average value of $\nu = 0.4$ also will be adequate for practical purposes.

Regarding an alternative approach, note that Eq. 5.6-5 for the period \tilde{T} of structures supported on mat foundations was deduced from Eq. 5.6-3 by making use of Eq. C5.6-10 and C5.6-11, with Poisson's ratio taken as $\nu = 0.4$ and with the radius r interpreted as r_a in Eq. C5.6-10 and as r_m in Eq. C5.6-11. For a nearly square foundation, for which $r_a \approx r_m \approx r$, Eq. 5.6-5 reduces to:

$$\tilde{T} = T \sqrt{1 + 25\alpha \left(\frac{r\bar{h}}{v_s^2 T^2} \right)} \left[1 + \left(\frac{1.12\bar{h}^2}{\alpha_\theta r^2} \right) \right] \quad (\text{C5.6-26})$$

The value of the relative weight parameter, α , is likely to be in the neighborhood of 0.15 for typical structures.

5.6.2.1.2 Effective damping. Equation 5.6-9 for the overall damping factor of the elastically supported structure, $\tilde{\beta}$, was determined from analyses of the harmonic response at resonance of simple systems of the type considered in Figures C5.6-2 and 5.6-3. The result is an expression of the form (Bielak, 1975; Veletsos and Nair, 1975) of:

$$\tilde{\beta} = \beta_o + \frac{0.05}{\left(\frac{\tilde{T}}{T} \right)^3} \quad (\text{C5.6-27})$$

in which β_o represents the contribution of the foundation damping, considered in greater detail in the following paragraphs, and the second term represents the contribution of the structural damping. The latter damping is assumed to be of the viscous type. Equation C5.6-27 corresponds to the value of $\beta = 0.05$ used in the development of the response spectra for rigidly supported systems employed in Sec. 5.2.

The foundation damping factor, β_o , incorporates the effects of energy dissipation in the soil due to the following sources: the radiation of waves away from the foundation, known as radiation or geometric damping, and the hysteretic or inelastic action in the soil, also known as soil material damping. This

factor depends on the geometry of the foundation-soil contact area and on the properties of the structure and the underlying soil deposits.

For mat foundations of circular plan that are supported at the surface of reasonably uniform soils deposits, the three most important parameters which affect the value of β_o are: the ratio (\tilde{T}/T) of the fundamental natural periods of the elastically supported and the fixed-base structures, the ratio \bar{h}/r of the effective height of the structure to the radius of the foundation, and the damping capacity of the soil. The latter capacity is measured by the dimensionless ratio $\Delta W_s/W_s$, in which ΔW_s is the area of the hysteresis loop in the stress-strain diagram for a soil specimen undergoing harmonic shearing deformation and W_s is the strain energy stored in a linearly elastic material subjected to the same maximum stress and strain (that is, the area of the triangle in the stress-strain diagram between the origin and the point of the maximum induced stress and strain). This ratio is a function of the magnitude of the imposed peak strain, increasing with increasing intensity of excitation or level of strain.

The variation of β_o with \tilde{T}/T and \bar{h}/r is given in Figure 5.6-1 for two levels of excitation. The dashed lines, which are recommended for values of the effective peak ground acceleration (taken as $0.4S_{DS}$) equal to or less than 0.10, correspond to a value of $\Delta W_s/W_s \approx 0.3$, whereas the solid lines, which are recommended for values of effective peak ground acceleration equal to or greater than 0.20, correspond to a value of $\Delta W_s/W_s \approx 1$. These curves are based on the results of extensive parametric studies (Veletsos, 1977; Veletsos and Meek, 1974; Veletsos and Nair, 1975) and represent average values. For the ranges of parameters that are of interest in practice, however, the dispersion of the results is small.

For mat foundations of arbitrary shape, the quantity r in Figure 5.6-1 should be interpreted as a characteristic length that is related to the length of the foundation, L_o , in the direction in which the structure is being analyzed. For short, squatty structures for which $\bar{h}/L_o \leq 0.5$, the overall damping of the structure-foundation system is dominated by the translational action of the foundation, and it is reasonable to interpret r as r_a , the radius of a disk that has the same area as that of the actual foundation (see Eq. 5.6-7). On the other hand, for structures with $\bar{h}/L_o \geq 0.1$, the interaction effects are dominated by the rocking motion of the foundation, and it is reasonable to define r as the radius r_m of a disk whose static moment of inertia about a horizontal centroidal axis is the same as that of the actual foundation normal to the direction in which the structure is being analyzed (see Eq. 5.6-8).

Subject to the qualifications noted in the following section, the curves in Figure 5.6-1 also may be used for embedded mat foundations and for foundations involving spread footings or piles. In the latter cases, the quantities A_o and I_o in the expressions for the characteristic foundation length, r , should be interpreted as the area and the moment of inertia of the load-carrying foundation.

In the evaluation of the overall damping of the structure-foundation system, no distinction has been made between surface-supported foundations and embedded foundations. Since the effect of embedment is to increase the damping capacity of the foundation (Bielak, 1975; Novak, 1974; Novak and Beredugo, 1972) and since such an increase is associated with a reduction in the magnitude of the forces induced in the structure, the use of the recommended requirements for embedded structures will err on the conservative side.

There is one additional source of conservatism in the application of the recommended requirements to structures with embedded foundations. It results from the assumption that the free-field ground motion at the foundation level is independent of the depth of foundation embedment. Actually, there is evidence to the effect that the severity of the free-field excitation decreases with depth (Seed et al., 1977). This reduction is ignored both in Sec. 5.6 and in the requirements for rigidly supported structures presented in Sec. 5.2 and 5.3.

Equations 5.6-9 and C5.6-28, in combination with the information presented in Figure 5.6-1, may lead to damping factors for the structure-soil system, $\tilde{\beta}$, that are smaller than the structural damping factor, β . However, since the representative value of $\beta = 0.05$ used in the development of the design requirements

for rigidly supported structures is based on the results of tests on actual structures, it reflects the damping of the full structure-soil system, not merely of the component contributed by the superstructure. Thus, the value of $\tilde{\beta}$ determined from Eq. 5.6-9 should never be taken less than β , and a minimum value of $\tilde{\beta} = \beta = 0.05$ has been imposed. The use of values of $\tilde{\beta} > \beta$ is justified by the fact that the experimental values correspond to extremely small amplitude motions and do not reflect the effects of the higher soil damping capacities corresponding to the large soil strain levels associated with the design ground motions. The effects of the higher soil damping capacities are appropriately reflected in the values of β_o presented in Figure 5.6-1.

There are, however, some exceptions. For foundations involving a soft soil stratum of reasonably uniform properties underlain by a much stiffer, rock-like material with an abrupt increase in stiffness, the radiation damping effects are practically negligible when the natural period of vibration of the stratum in shear,

$$T_s = \frac{4D_s}{v_s} \quad (\text{C5.6-28})$$

is smaller than the natural period of the flexibly supported structure, \tilde{T} . The quantity D_s in this formula represents the depth of the stratum. It follows that the values of β_o presented in Figure 5.6-1 are applicable only when:

$$\frac{T_s}{\tilde{T}} = \frac{4D_s}{v_s \tilde{T}} \geq 1 \quad (\text{C5.6-29})$$

For

$$\frac{T_s}{\tilde{T}} = \frac{4D_s}{v_s \tilde{T}} < 1 \quad (\text{C5.6-30})$$

the effective value of the foundation damping factor, β'_o , is less than β_o , and it is approximated by the second degree parabola defined by Eq. 5.6-10.

For $T_s / \tilde{T} = 1$, Eq. 5.6-10 leads to $\beta'_o = \beta_o$ whereas for $T_s / \tilde{T} = 0$, it leads to $\beta'_o = 0$, a value that clearly does not provide for the effects of material soil damping. It may be expected, therefore, that the computed values of β'_o corresponding to small values of T_s / \tilde{T} will be conservative. The conservatism involved, however, is partly compensated by the requirement that $\tilde{\beta}$ be no less than $\tilde{\beta} = \beta = 0.05$.

5.6.2.2 and 5.6.2.3 Vertical distribution of seismic forces and other effects. The vertical distributions of the equivalent lateral forces for flexibly and rigidly supported structures are generally different. However, the differences are inconsequential for practical purposes, and it is recommended that the same distribution be used in both cases, changing only the magnitude of the forces to correspond to the appropriate base shear. A greater degree of refinement in this step would be inconsistent with the approximations embodied in the requirements for rigidly supported structures.

With the vertical distribution of the lateral forces established, the overturning moments and the torsional effects about a vertical axis are computed as for rigidly supported structures. The above procedure is applicable to planar structures and, with some extension, to three-dimensional structures.

5.6.3 Response spectrum procedure. Studies of the dynamic response of elastically supported, multi-degree-of-freedom systems (Bielak, 1976; Chopra and Gutierrez, 1974; Veletsos, 1977) reveal that, within the ranges of parameters that are of interest in the design of structures subjected to earthquakes, soil-structure interaction affects substantially only the response component contributed by the fundamental mode of vibration of the superstructure. In this section, the interaction effects are considered only in evaluating the contribution of the fundamental structural mode. The contributions of the higher modes are computed as if the structure were fixed at the base, and the maximum value of a response

quantity is determined, as for rigidly supported structures, by taking the square root of the sum of the squares of the maximum modal contributions.

The interaction effects associated with the response in the fundamental structural mode are determined in a manner analogous to that used in the equivalent lateral force procedure, except that the effective weight and effective height of the structure are computed so as to correspond exactly to those of the fundamental natural mode of the fixed-base structure. More specifically, \bar{W} is computed from:

$$\bar{W} = \bar{W}_1 = \frac{(\sum w_i \phi_{i1})^2}{\sum w_i \phi_{i1}^2} \quad (\text{C5.6-31})$$

which is the same as Eq. 5.3-2, and \bar{h} is computed from Eq. 5.6-13. The quantity ϕ_{i1} in these formulas represents the displacement amplitude of the i^{th} floor level when the structure is vibrating in its fixed-base, fundamental natural mode. The structural stiffness, \bar{k} , is obtained from Eq. 5.6-4 by taking $\bar{W} = \bar{W}_1$ and using for T the fundamental natural period of the fixed-base structure, T_1 . The fundamental natural period of the interacting system, \tilde{T}_1 , is then computed from Eq. 5.6-3 (or Eq. 5.6-5 when applicable) by taking $T = T_1$. The effective damping in the first mode, β , is determined from Eq. 5.6-9 (and Eq. 5.6-10 when applicable) in combination with the information given in Figure 5.6-1. The quantity \bar{h} in the latter figure is computed from Eq. 5.6-13.

With the values of \tilde{T}_1 and $\tilde{\beta}_1$ established, the reduction in the base shear for the first mode, ΔV_1 , is computed from Eq. 5.6-2. The quantities C_s and \tilde{C}_s in this formula should be interpreted as the seismic coefficients corresponding to the periods T_1 and \tilde{T}_1 , respectively; $\tilde{\beta}$ should be taken equal to $\tilde{\beta}_1$; and \bar{W} should be determined from Eq. C5.6-31.

The sections on lateral forces, shears, overturning moments, and displacements follow directly from what has already been noted in this and the preceding sections and need no elaboration. It may only be pointed out that the first term within the brackets on the right side of Eq. 5.6-14 represents the contribution of the foundation rotation.

5.6.3.3 Design values. The design values of the modified shears, moments, deflections, and story drifts should be determined as for structures without interaction by taking the square root of the sum of the squares of the respective modal contributions. In the design of the foundation, the overturning moment at the foundation-soil interface determined in this manner may be reduced by 10 percent as for structures without interaction.

The effects of torsion about a vertical axis should be evaluated in accordance with the requirements of Sec. 5.2.4 and the P -delta effects should be evaluated in accordance with the requirements of Sec. 5.2.6.2, using the story shears and drifts determined in Sec. 5.6.3.2.

Other methods of considering the effects of soil-structure interaction. The procedures proposed in the preceding sections for incorporating the effects of soil-structure interaction provide sufficient flexibility and accuracy for practical applications. Only for unusual structures and only when the requirements indicate that the interaction effects are of definite consequence in design, would the use of more elaborate procedures be justified. Some of the possible refinements, listed in order of more or less increasing complexity, are:

1. Improve the estimates of the static stiffnesses of the foundation, K_y and K_θ , and of the foundation damping factor, β_0 , by considering in a more precise manner the foundation type involved, the effects of foundation embedment, variations of soil properties with depth, and hysteretic action in the soil. Solutions may be obtained in some cases with analytical or semi-analytical formulations and in others by application of finite difference or finite element techniques. A concise review of available analytical formulations is provided in Gazetas (1991). It should be noted, however, that these

solutions involve approximations of their own that may offset, at least in part, the apparent increase in accuracy.

2. Improve the estimates of the average properties of the foundation soils for the stipulated design ground motion. This would require both laboratory tests on undisturbed samples from the site and studies of wave propagation for the site. The laboratory tests are needed to establish the actual variations with shearing strain amplitude of the shear modulus and damping capacity of the soil, whereas the wave propagation studies are needed to establish realistic values for the predominant soil strains induced by the design ground motion.
3. Incorporate the effects of interaction for the higher modes of vibration of the structure, either approximately by application of the procedures recommended in Bielak (1976), Roesset et al. (1973), and Tsai (1974) or by more precise analyses of the structure-soil system. The latter analyses may be implemented either in the time domain or by application of the impulse response functions presented in Veletsos and Verbic (1974). However, the frequency domain analysis is limited to systems that respond within the elastic range while the approach involving the use of the impulse response functions is limited, at present, to soil deposits that can adequately be represented as a uniform elastic halfspace. The effects of yielding in the structure and/or supporting medium can be considered only approximately in this approach by representing the supporting medium by a series of springs and dashpots whose properties are independent of the frequency of the motion and by integrating numerically the governing equations of motion (Parmelee et al., 1969).
4. Analyze the structure-soil system by finite element method (for example, Lysmer et al., 1981; Borja et al., 1992), taking due account of the nonlinear effects in both the structure and the supporting medium.

It should be emphasized that, while these more elaborate procedures may be appropriate in special cases for design verification, they involve their own approximations and do not eliminate the uncertainties that are inherent in the modeling of the structure-foundation-soil system and in the specification of the design ground motion and of the properties of the structure and soil.

REFERENCES

- Anderson, D. G., and F. E. Richart, Jr. 1976. "Effects of Straining on Shear Modulus of Clays." *Journal of the ASCE Geotechnical Engineering Division* 102 (679):975-987.
- Arias, A., and R. Husid. 1965. "Influence of Damping on Earthquake Response of Structures." *Revista del IDIEM* 1 (3). In Spanish.
- Ballard, R. F., and F. G. McLean. 1975. "Seismic Field Methods for In Situ Moduli." In *Proceedings of the Conference on In Situ Measurement of Soil Properties*, Vol. I, pp. 121-150. North Carolina State University.
- Bernal, D. 1987. "Amplification Factors for Inelastic Dynamic P-delta Effects in Earthquake Analysis." *Earthquake Engineering and Structural Dynamics*, 15:835-881.
- Bielak, J. 1976. "Modal Analysis for Building-Soil Interaction." *Journal of the ASCE Engineering Mechanics Division* 102 (EM5):771-786.
- Bielak, J. 1975. "Dynamic Behavior of Structures with Embedded Foundations." In *Earthquake Engineering and Structural Dynamics*, Vol. 3, pp. 259-274.
- Borja, R. I., H. A. Smith, W-H. Wu, and A. P. Amies. 1992. *A methodology for nonlinear soil-structure interaction effects using time-domain analysis techniques*, Report 101. Stanford, California: Blume Earthquake Engineering Center.
- Chang, G.A. and Mander, J.B., "Seismic Energy Based Fatigue Damage Analysis of Bridge Columns: Part II-Evaluation of Seismic Demand," NCEER-94-0013, National Center for Earthquake Engineering Research, State University of New York at Buffalo, 1994.

- Chopra, Anil K., *Dynamics of Structures: Theory and Application to Earthquake Engineering*, Prentice-Hall, Englewood Cliffs, New Jersey, 1995.
- Chopra, A. K., and J. A. Gutierrez. 1974. "Earthquake Analysis of Multistory Buildings Including Foundation Interaction." *Journal of Earthquake Engineering and Structural Dynamics* 3:65-67.
- Clough, R. W. and J. Penzien. 1975. *Dynamics of Structures*. New York: McGraw-Hill.
- Elsabee, F., I. Kausel, and J. M. Roesset. 1977. "Dynamic Stiffness of Embedded Foundations." In *Proceedings of the ASCE Second Annual Engineering Mechanics Division Specialty Conference*, pp. 40-43.
- Erden, S. M. 1974. Influence of Shape and Embedment on Dynamic Foundation Response. Thesis submitted in partial fulfillment of the requirements for the degree of Doctor of Philosophy, University of Massachusetts, Amherst.
- Gazetas, G. 1991. "Foundation Vibrations," in *Foundation Engineering Handbook*, 2nd edition, edited by H.-Y. Fang.
- Goel, R. K., and A. K. Chopra. 1998. "Period Formulas for Concrete Shear Wall Buildings." *Journal of Structural Engineering*, ASCE, April.
- Goel, R. K., and A. K. Chopra. 1997. "Period Formulas for Moment-Resisting Frame Buildings." *Journal of Structural Engineering*, ASCE, November.
- Hara, A., T. Ohta, M. Niwa, S. Tanaka, and T. Banno. 1974. "Shear Modulus and Shear Strength of Cohesive Soils." *Journal of the Japanese Society of Soil Mechanics and Foundation Engineering* 14 (3):1-24.
- Hardin, B. O. 1978. "The Nature of Stress-Strain Behavior of Soils," *Earthquake Engineering and Soil Dynamics*, ASCE, Vol. I, 3-90.
- Hardin, B. O., and V. P. Drnevich. 1975. "Shear Modulus and Damping in Soils: Design Equations and Curves." *Journal of the ASCE Soil Mechanics and Foundation Division* 98 (SM7):667-695.
- Jennings, P. C., and J. Bielak. 1973. "Dynamics of Building-Soil Interaction." *Bulletin of Seismology Society of America* 63 (1):9-48.
- Kausel, E. 1974. *Forced Vibrations of Circular Foundations on Layered Media*, Report R74-11. Cambridge: Massachusetts Institute of Technology.
- Kausel, E., and J. M. Roesset. 1975. "Dynamic Stiffness of Circular Foundations." *Journal of the ASCE Engineering Mechanics Division* 101 (EM6):771-785.
- Kramer, S. L. 1996. *Geotechnical Earthquake Engineering*. Upper Saddle River, New Jersey: Prentice-Hall.
- Kuribayashi, E., T. Iwasaki, and F. Tatsuoka. 1974. "Effects of Stress Conditions on Dynamic Properties of Sands." *Bulletin of the International Institute of Seismology and Earthquake Engineering* 12:117-130.
- Liu, S. C., and L. W. Fagel. 1971. "Earthquake Interaction by Fast Fourier Transform." *Journal of the ASCE Engineering Mechanics Division* 97 (EM4):1223-1237.
- Luco, J. E. 1974. "Impedance Functions for a Rigid Foundation on a Layered Medium." *Nuclear Engineering and Design* (31):204-217.
- Lysmer, J., M. Tabatabaie-Raissi, F. Tajirian, S. Vahdani, and F. Ostadan. 1981. *SASSI: A System for Analysis of Soil-Structures Interaction*, Report UCB/GT-81/02. Berkeley: University of California.
- Miranda, E. and Bertero, V.V., "Evaluation of Strength Reduction Factors for Earthquake Resistant Design," *Earthquake Spectra*, Vol. 10, No. 2, pp. 357-380, 1994.
- Nair, K., H. Gray, and N. C. Donovan. 1969. *Analysis of Pile Group Behavior*. ASTM Special Technical Publication 44.

- Nassar, A.A., and Krawinkler, H., *Seismic Demands for SDOF and MDOF Systems*, Report No. 95, the John A. Blume Earthquake Engineering Center, Stanford University, Stanford, California, June, 1991.
- Newmark, N. M., J. A. Blume, and K. K. Kapur. 1973. "Seismic Design Spectra for Nuclear Power Plants." *Journal of the ASCE Power Division* 99 (PO 2):873-889.
- Newmark, N. M., and E. Rosenblueth. 1971. *Fundamentals of Earthquake Engineering*. New York: Prentice-Hall.
- Novak, M. 1974. "Effect of Soil on Structural Response to Wind and Earthquake." In *Earthquake Engineering and Structural Dynamics*, Vol. 3, pp. 79-96.
- Novak, M., and Y. O. Beredugo. 1975. "Vertical Vibrations of Embedded Footings." *Journal of the ASCE Soil Mechanics and Foundations Division* 98 (SM12):1291-1310.
- Novak, M. 1974. "Dynamic Stiffness and Damping of Piles." *Canadian Geotechnical Journal* 11:574-598.
- Parmelee, R. A., D. S. Perelman, and S. L. Lee. 1969. "Seismic Response of Multistory Structures on Flexible Foundations." *Bulletin of the Seismological Society of America* 29:1061-1070.
- Poulos, H. G. and E. H. Davis. 1974. *Elastic Solutions for Soil and Rock Mechanics*. New York: Wiley and Sons.
- Rainer, J. H. 1975. "Simplified Analysis of Dynamic Structure-Ground Interaction." *Canadian Journal of Civil Engineering* 2 (3):345-356.
- Rainer, J. H. 1975. "Damping in Dynamic Structure-Foundation Interaction." *Canadian Geotechnical Journal* 12:13-25.
- Richart, F. E., J. R. Hall, Jr., and R. D. Woods. *Vibrations of Soils and Foundations*. Englewood Cliffs, New Jersey: Prentice-Hall.
- Roesset et al. 1973.
- Rutenburg, A. 1985. "Simplified P-delta Analysis for Asymmetric Structures." *Journal of the Structural Division, ASCE*, 108(ST9).
- Seed, H. B., R. T. Wong, I. M. Idriss, and K. Tokimatsu. 1984. "Moduli and Damping Factors for Dynamic Analyses of Cohesionless Soils." *Rpt. No. UCB/EERC-84/14*, Earthquake Engineering Research Center, Univ. of California, Berkeley.
- Seed, H. B., J. Lysmer, and R. Hwang. 1974. "Soil-Structure Interaction Analysis for Seismic Response." *Journal of the ASCE Geotechnical Engineering Division* 101 (GT5):439-457.
- Seed, H. B., R. V. Whitman, and J. Lysmer. 1977. "Soil-Structure Interaction Effects in the Design of Nuclear Power Plants." In *Structural and Geotechnical Mechanics, A Volume Honoring N. M. Newmark*, edited by W. J. Hall. Englewood Cliffs, New Jersey: Prentice-Hall.
- Stokoe, K. H., II, and R. D. Woods. 1975. "In Situ Shear Wave Velocity by Cross-Hole Method." *Journal of the ASCE Soil Mechanics and Foundations Division* 98 (SM5):443-460.
- Structural Engineers Association of California. 1968, 1973, 1974, 1976, and 1987. *Recommended Lateral Force Requirements and Commentary*. San Francisco: SEAOC.
- Thomson, W. T. 1965. *Vibration Theory and Application*. New York: Prentice-Hall.
- Tomlinson, M.J. 1994. *Pile Design and Construction Practice*, E&FN Spon, London, UK, 4th Edition.
- Tsai, N. C. 1974. "Modal Damping for Soil-Structure Interaction." *Journal of the ASCE Engineering Mechanics Division* 100 (EM2):323-341.
- Vaish, A. K., and A. K. Chopra. 1974. "Earthquake Finite Element Analysis of Structure-Foundation Systems." *Journal of the ASCE Engineering Mechanics Division* 100 (EM6):1011-1016.

- Veletsos, A. S., and V. V. Nair. 1975. "Seismic Interaction of Structures on Hysteretic Foundations." *Journal of the ASCE Structural Division* 101 (ST1):109-129.
- Veletsos, A. S. 1977. "Dynamics of Structure-Foundation Systems." In *Structural and Geotechnical Mechanics, A Volume Honoring N. M. Newmark*, edited by W. J. Hall, pp. 333-361. Englewood Cliffs, New Jersey: Prentice-Hall.
- Veletsos, A. S., and J. W. Meek. 1974. "Dynamic Behavior of Building Foundation Systems." *Earthquake Engineering and Structural Dynamics* 3 (2):121-138.
- Veletsos, A. S., and B. Verbic. 1973. "Vibration of Viscoelastic Foundations." *Earthquake Engineering and Structural Dynamics* 2 (1): 87-105.
- Veletsos, A. S., and Y. T. Wei. 1971. "Lateral and Rocking Vibration of Footings." *Journal of the ASCE Soil Mechanics and Foundations Division* 97 (SM9):1227-1248.
- Veletsos, A. S., and B. Verbic. 1974. "Basic Response Functions for Elastic Foundations." *Journal of the ASCE Engineering Mechanics Division* 100 (EM2):189-205.
- Vidic, T., Fajfar, P., and Fischinger, M. 1992. "A Procedure for Determining Consistent Inelastic Design Spectra," Proc. Workshop of Nonlinear Seismic Analysis of RC Structures, Bled, Slovenia, July, 1992.
- Vucetic, M., and R. Dobry. 1991. "Effect of Soil Plasticity on Cyclic Response." *J. Geotech. Engrg.* ASCE, 117(1), 89-107.
- Wallace, J. W., J. P. Stewart, and A. S. Whittaker, editors. 1999. *Building Vulnerability Studies: Modeling and Evaluation of Tilt-up and Steel Reinforced Concrete Buildings*, Report to PEER-PG&E Cooperative Research Program. Los Angeles: University of California Department of Civil and Environmental Engineering.
- Wiegel, R. L., Ed. 1970. *Earthquake Engineering*. New York: Prentice-Hall.
- Wilson, E. L., and A. Habibullah. 1987. "Static and Dynamic Analysis of Multi-story Buildings Including P-delta Effects." *Earthquake Spectra* 3(2).

This page is intentionally left blank.

Appendix to Chapter 5

NONLINEAR STATIC PROCEDURE

A5.2 NONLINEAR STATIC PROCEDURE

The nonlinear static procedure is intended to provide a simplified approach for directly determining the nonlinear response behavior of a structure at different levels of lateral displacements, ranging from initial elastic response through development of a failure mechanism and initiation of collapse. Response behavior is gauged by measurement of the strength of the structure, at various increments of lateral displacement.

Usually the shear resisted by the system at yield of the first element of the structure is defined as the “elastic strength,” although this may not correspond to yield of the entire structure. When traditional linear methods of design (using R factors) are employed, this elastic strength will not be less than the design base shear.

If a structure is subjected to larger lateral loads than that represented by the elastic strength, a number of elements will yield—eventually forming a mechanism. For most structures, multiple configurations of mechanisms are possible. The mechanism caused by the smallest set of forces is likely to appear before others do. That mechanism is considered to be the dominant mechanism. Standard methods of plastic or “limit” analysis can be used to determine the strength corresponding to such mechanisms. However, such “limit analysis” cannot determine the deformation at the onset of such a mechanism. If the yielding elements are able to strain harden, the mechanism will not allow an increase of deformations without some increase of lateral forces and the mechanism is stable. Moreover, it can be considered as a flexible version of the original frame structure. Figure CA5.2-1, which shows a plot of the lateral structural strength vs. deformation (or pushover curve) for a hypothetical structure, illustrates these concepts.

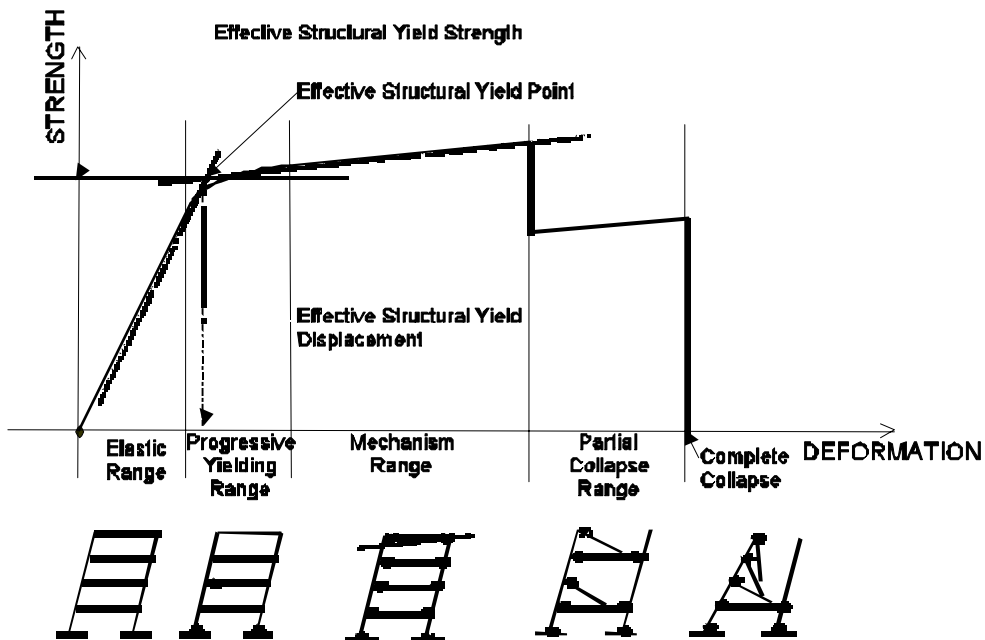

Figure CA5.2-1 Strength-deformation relation for a frame structure

If, after the structure develops a mechanism, it deforms an additional substantial amount, elements within the structure may fail (fracture, buckle, etc.) and thus cease to contribute strength to the structural system. In such cases, the strength of the structure will diminish with increasing deformation. In the event of failure of an essential element, or group of elements, the entire structure may lose capacity to carry the gravity or lateral loads. Such loss of load-carrying capacity can also occur if the lateral deformation becomes so great that the P -delta effects exceed the residual lateral stiffness of the structure. Such conditions are defined as collapse and the deformation associated with collapse is defined as the “ultimate deformation.” This deformation can be determined by the nonlinear static procedure and also by plastic or limit analysis.

As shown in Figure CA5.2-1, many structures exhibit a range of behavior between the development of first yielding and development of a mechanism. When the structure deforms while elements are yielding sequentially (shown as progressive yielding), the relation between external forces and deformations cannot be determined by simple limit analysis. For such a case, other methods of analysis are required. The purpose of nonlinear static procedure is to provide a simplified method of determining structural response behavior at deformation levels between those that can be conveniently analyzed using limit state methods.

A5.2.1 Modeling. In this procedure, the structure is modeled using elements having stiffness properties that are dependent on the amount of deformation imposed on the element. All elements that can be subjected to deformations or forces larger than those corresponding to yield should be modeled with nonlinear properties. At a minimum, nonlinear stiffness properties (using a bilinear model) should include initial elastic stiffness, yield strength (and yield deformation), and post-yield characteristics including the point of loss of strength (and associated deformation) or point of complete fracture or loss of stability.

A5.2.2 Lateral loads. The analysis is performed by applying an incrementally increasing pattern of lateral loads distributed throughout the structure. The analysis traces the internal distribution of loads and deformations as the load amplitude is progressively increased. Moreover it records the strength-deformation relation and the characteristic events occurring as the analysis progresses. The strength-deformation relation typically takes a shape similar to that shown in Figure CA5.2-1.

It should be noted that nonlinear static analysis can be used to determine the order of yielding of elements in the “progressive yielding range” (see Figure CA5.2-1) and the associated strengths and deformations. The analysis can also identify the deformations associated with fractures or failure of components and the entire structure. However, it is accurate only if the applied pattern of loads induces a pattern of deformation in the structure that is similar to that which will be induced by the earthquake ground motion. This can be controlled, to some extent, through application of an appropriate pattern of loads. However, this method is generally limited in applicability to structures that have limited higher-mode participation.

The force-deformation sequence predicted by the analysis is a function of the configuration of the set of monotonically increasing loads. In order to capture the dynamic behavior of the structure, the force-deformation relation should be properly defined as the instantaneous distribution of inertial forces when the maximum response of structure occurs. Therefore, the load configuration should be redefined at each point on the pushover curve, proportional to the instantaneous configuration of inertial forces. Such a configuration is dependent on the instantaneous modal characteristics of the structure and their combination. Since the structure is nonlinear, the instantaneous modal characteristics depend on the modified properties due to inelastic deformations, affecting the load distribution at each step, accordingly.

Such use of a varying, deformation-dependent load configuration would require almost as much labor and uncertainty as application of a full nonlinear response history procedure. Such effort would be inappropriate for the simplified approach that the nonlinear static procedure is intended to provide. Therefore, the load configuration and intensity are approximated in the nonlinear static procedures. Several approximations are available, including the following:

1. An approximate distribution proportional to the idealized elastic response model as used in the equivalent lateral force procedure:

$$F_i = \frac{w_i h_i^k}{\sum_j w_j h_j^k} V \quad (\text{CA5.2-1})$$

where, F , w , h and V are the story inertia force, story weight, story height, and base shear, respectively; k is a coefficient ranging between 1 and 2, as defined in *Provisions* Sec. 5.2.3.

2. A better approximation, using the dominant mode of vibration (such as the first mode in moderate height building structures):

$$F_i = \frac{w_i \phi_i}{\sum_i w_i \phi_i} V \quad (\text{CA5.2-2})$$

where, ϕ_i is the dominant mode shape. This approximation allows the three-dimensional distribution of inertia forces to be obtained when such considerations are important.

3. A still more complete approximation using several significant modes of vibration. In such cases the modes for which the total equivalent modal mass exceed 90 percent should be included. The load configuration is given by:

$$F_i = \frac{w_i \phi_{id} \left[\sum \left[(\Gamma_i / \Gamma_d) (S_{ai} / S_{ad}) \right]^2 \right]^{1/2}}{\sum w_i \phi_{id} \left[\sum \left[(\Gamma_i / \Gamma_d)^2 (S_{ai} / S_{ad}) \right]^2 \right]^{1/2}} V \quad (\text{CA5.2-3})$$

where, Γ_i and S_{ai} are the modal participation factor and the spectral acceleration, respectively, and subscript d indicates the dominant mode. ($\Gamma_i = \sum w_i \phi_i$; where the mode shapes, ϕ , are mass normalized—that is $\sum w_i \phi_i^2 / g = 1$.)

4. An approximation that takes into account both higher mode contributions and changes in the loading due to yielding of the structure. In this case the load configuration described by Eq. CA5.2-3) is calculated and reevaluated when the modal characteristics of the structure change as it yields. Such procedure has also termed an “adaptive push-over analysis.”

The *Provisions* adopt the simplest of these approaches, indicated as item 1 above, though use of the more complex approaches is not precluded. Nonlinear static analysis options exist in several commercially available and public-domain analysis platforms.

A5.2.3 Target displacement. The nonlinear analysis should be continued by increasing the amplitude of the pattern of lateral loads until the deflections at the control point exceeds 150 percent of the target displacement. The expected inelastic deflection at each level shall be determined by combining the elastic modal values as obtained from Sec. 5.3.5 and 5.3.6 multiplied by the factor

$$C = \frac{(1 - T_s / T_l)}{R_d} + (T_s / T_l) \quad (\text{CA5.2-4})$$

where T_s is the characteristic period of the response spectrum, defined as the period associated with the transition from the constant-acceleration segment of the spectrum to the constant-velocity segment of the spectrum and R_d is the ratio of the total design base shear to the fully yielded strength of the major mechanism, which can be obtained according to $R_d = R / \Omega_o$, with R and Ω_o given in Table 4.3-1. The combination shall be carried out by taking the square root of the sum of the squares of each of the modal values or by the complete quadratic combination technique.

The recommendation linking the expected inelastic deformation to the elastic is based on an approach originally suggested by Newmark and on later studies by several other researchers. These are described below.

In a 1991 study, Nassar and Krawinkler published simplified expressions that were derived from a study of mean strength reduction factors computed from fifteen ground motions recorded in the Western United States. The records used were obtained at alluvium and rock sites. The influence of the site conditions was not explicitly considered. The sensitivity of mean strength reduction factors to epicentral distance, yield level, strain-hardening ratio, and stiffness degradation was examined. The study concluded that epicentral distance and stiffness degradation have negligible influence on strength reduction factors and proposed the following relationship for the ratio of inelastic displacements to displacements predicted by elastic analysis:

$$R_d = \left[1 + \frac{1}{c} (r^c - 1) \right] / r \geq 1 \quad (\text{CA5.2-5})$$

where,

$$c = \frac{T^a}{1 + T^a} + \frac{b}{T} \quad (\text{CA5.2-6})$$

In the above, T , is the period of vibration of the structure and r is the strength ratio. R_d is defined above.

In 1994, Chang and Mander performed analytical studies based on an envelope of five recorded ground motions. The following inelastic dynamic magnification factor that relates the maximum inelastic displacement to the elastic spectral displacement was obtained.

$$R_D = \left(1 - \frac{1}{r} \right) \left(\frac{T_{PV}}{T} \right)^n + \frac{1}{r} \geq 1 \quad (\text{CA5.2-7})$$

where T_{PV} is the period at which the maximum spectral velocity response occurs, and

$$n = 1.2 + 0.025r \text{ for } T_{PV} \leq 1.2 \text{ sec.} \quad (\text{CA5.2-8})$$

$$n = 1.2 \text{ for } T_{PV} > 1.2 \text{ sec.} \quad (\text{CA5.2-9})$$

In 1992, Vidic, Fajfar, and Fischinger recommended simplified expressions derived from the study of the mean strength reduction factors computed from twenty ground motions recorded in the Western United States as well as in the 1979 Montenegro, Yugoslavia, earthquake. Systems with bilinear and stiffness degrading (Q-model) hysteric behavior and viscous damping proportional to the mass and the instantaneous stiffness were considered, resulting in the following expression:

$$R_D = \left(1 - \frac{1}{r} \right) \frac{T_0}{T} + \frac{1}{r} \geq 1 \quad (\text{CA5.2-10})$$

where T is the dominant period of structure, $T_0 = 0.65\mu^{0.3}T_I$, and

$$T_I = 2\pi \frac{\phi_{ev} V}{\phi_{ea} A} \quad (\text{CA5.2-11})$$

where V and A are the peak ground velocity and peak ground acceleration, respectively. For the 20 ground motions considered in the study, the mean amplification factors ϕ_{ea} and ϕ_{ev} are 2.5 and 2.0, respectively.

Miranda and Bertero (1994) suggested simplified expressions derived from the study of the mean strength reduction factors computed from 124 ground motions recorded on a wide range of soil conditions. The study considered 5-percent-damped bilinear systems undergoing displacement ductility ratios between 2 and 6. Based on the local site conditions at the recording station, ground motions were classified into three groups: rock sites, and soft soil sites. In addition to the influence of soil conditions, the study considered the influence of magnitude and epicentral distance on strength reduction factors. The study concluded that soil conditions influence the reduction factors significantly (particularly for soft soil sites)

and that magnitude and epicentral distance have a negligible effect on mean strength reduction factors. The study produced the following expression for the mean strength reduction factor:

$$R_D = \left(1 - \frac{1}{r}\right)\Phi + \frac{1}{r} \quad (\text{CA5.2-12})$$

with,

$$\Phi = 1 + \frac{1}{10T - \mu T} - \frac{1}{2T} \exp\left[-\frac{3}{2}\left(\ln T - \frac{3}{5}\right)^2\right] \quad (\text{CA5.2-13})$$

$$\Phi = 1 + \frac{1}{12T - \mu T} - \frac{2}{5T} \exp\left[-2\left(\ln T - \frac{1}{5}\right)^2\right] \quad (\text{CA5.2-14})$$

$$(\text{CA5.2-15})$$

where T is the period of vibration of the structure and T_g is the characteristic ground motion period.

The recommended formulation contained in the *Provisions* is a combination of the recommendations of Krawinkler et al and of Vidic et al with some simplification. The *Provisions* require that the analysis be continued until the deflection at the control point exceeds 150 percent of the target displacement in order to account for inaccuracy due to this simplification and because small variations in strength (due to modeling or due to imprecise construction) can lead to large displacement variations in the inelastic range.

A5.2.5 Design review. See *Commentary* Sec. 5.5.4.

This page is intentionally left blank.

Chapter 6 Commentary

ARCHITECTURAL, MECHANICAL, AND ELECTRICAL COMPONENT DESIGN REQUIREMENTS

6.1 GENERAL

6.1.1 Scope. The general requirements establish minimum design levels for architectural, mechanical, electrical, and other nonstructural systems and components recognizing occupancy use, occupant load, need for operational continuity, and the interrelation of structural and architectural, mechanical, electrical, and other nonstructural components. Several classes of components are not subject to the *Provisions*:

1. All components in Seismic Design Category A are exempted because of the lower seismic input for these items.
2. All mechanical and electrical components in Seismic Design Categories B and C are exempted if they have an importance factor (I_p) equal to 1.00 because of the low acceleration and the classification that they do not contain hazardous substances and are not required to function to maintain life safety.
3. All components in all Seismic Design Categories, weighing less than 400 pounds (1780 N), and mounted 4 ft (1.22 m) or less above the floor are exempted if they have an importance factor (I_p) equal to 1.00, because they do not contain hazardous substances, are not required to function to maintain life safety, and are not considered to be mounted high enough to be a life-safety hazard if they fall.

Storage racks are considered nonbuilding structures and are covered in *Provisions* Chapter 14. See *Commentary* Sec. 14.3.5.

Storage tanks are considered nonbuilding structures and are covered in *Provisions* Chapter 14. See *Commentary* Sec. 14.4.7.

When performing seismic design of nonstructural components, be aware that there may be important non-seismic requirements outside the scope of the building code, that may be affected by seismic bracing. For example, thermal expansion is often a critical design consideration in pressure piping systems, and bracing must be arranged in a manner that accommodates thermal movements. The design for seismic loads should not compromise the functionality, durability, or safety of the overall system, and this may require substantial collaboration and cooperation between the various disciplines in the design team. In some cases, such as essential facilities or hazardous environments, it may be appropriate to consider performance levels higher than what is required by the building code (for example, operability of a piping system, rather than leak tightness).

For some components, such as exterior walls, the wind design forces may be higher than the seismic design forces. Even when this occurs, the seismic detailing requirements may still govern the overall structural design. Whenever this is a possibility, it should be investigated early in the structural design process.

6.2 GENERAL DESIGN REQUIREMENTS

6.2.2 Component importance factor. The component importance factor (I_p) represents the greater of the life-safety importance of the component and the hazard-exposure importance of the structure. This

factor indirectly accounts for the functionality of the component or structure by requiring design for a higher force level. Use of higher I_p requirements together with application of the requirements in Sec. 6.4.2 and 6.4.3 should provide better, more functional component. While this approach will provide a higher degree of confidence in the probable seismic performance of a component, it may not be sufficient for all components. For example, individual ceiling tiles may still fall from the ceiling grid. Seismic qualification approaches presently in use by the Department of Energy (DOE) and the Nuclear Regulatory Commission (NRC) should be considered by the registered design professional and/or the owner when the consequences of failure would be unacceptable.

Components that could fall from the structure are among the most hazardous building components in an earthquake. These components may not be integral with the structural system and may cantilever horizontally or vertically from their supports. Critical issues affecting these components include their weight, their attachment to the structure, their breakage characteristics (glass) and their location (over an entry or exit, public walkway, atrium, or lower adjacent structure). Examples of items that may pose a falling hazard include parapets, cornices, canopies, marquees, glass, and precast concrete cladding panels. In addition, mechanical and electrical components may pose a falling hazard (for example, a rooftop tank or cooling tower, which if separated from the structure would fall to the ground).

Special consideration should be given to components that could block means of egress or exitways if they were to fall during an earthquake. The term “means of egress” has been defined in the same way throughout the country, since egress requirements have been included in building codes because of fire hazard. The requirements for exitways include intervening aisles, doors, doorways, gates, corridors, exterior exit balconies, ramps, stairways, pressurized enclosures, horizontal exits, exit passageways, exit courts, and yards. Example items that should be included when considering egress include walls around stairs and corridors, and veneers, cornices, canopies, and other ornaments above building exits. In addition, heavy partition systems vulnerable to failure by collapse, ceilings, soffits, light fixtures, or other objects that could fall or obstruct a required exit door or component (rescue window or fire escape) could be considered major obstructions. Examples of components that do not pose a significant falling hazard include fabric awnings and canopies and architectural, mechanical, and electrical components which, if separated from the structure, will fall in areas that are not accessible (in an atrium or light well not accessible to the public, for instance).

In Sec. 1.2.1 the intent is that Group III structures shall, in so far as practical, be provided with the capacity to function after an earthquake. To facilitate this, all nonstructural components and equipment in structures in Seismic Use Group III, and in Seismic Design Category C or higher, should be designed with an I_p equal to 1.5. All components and equipment are included because damage to vulnerable unbraced systems or equipment may disrupt operations following an earthquake, even if they are not “life-safety” items. Nonessential items can be considered “black boxes.” There is no need for component analysis as discussed in Sec. 6.4.2 and 6.4.3, since operation of these secondary items is not critical to the post-earthquake operability of the structure. Instead, the design may focus on their supports and attachments.

6.2.3 Consequential damage. Although the components included in Tables 6.3-1 and 6.4-1 are listed separately, significant interrelationships exist among them and should not be overlooked. For example, exterior, nonstructural, spandrel walls may shatter and fall on the streets or walks below, seriously hampering accessibility and egress functions. Further, the rupture of one component could lead to the failure of another that is dependent on the first. Accordingly, the collapse of a single component ultimately may lead to the failure of an entire system. Widespread collapse of suspended ceilings and light fixtures in a building may render an important space or major exit stairway unusable.

Consideration also was given to the design requirements for these components to determine how well they are conceived for their intended functions. Potential beneficial and/or detrimental interactions with the structure were examined. The interrelationship between components and their attachments were surveyed. Attention was given to the performance relative to each other of architectural, mechanical,

and electrical components; building products and finish materials; and systems within and without the building structure. It should be noted that the modification of one component in Table 6.3-1 or 6.4-1 could affect another and, in some cases, such a modification could help reduce the risk associated with the interrelated unit. For example, landscaping barriers around the exterior of certain buildings could decrease the risk due to falling debris although this should not be interpreted to mean that all buildings must have such barriers.

The design of components that are in contact with or in close proximity to structural or other nonstructural components must be given special study to avoid damage or failure when seismic motion occurs. An example is where an important element, such as a motor generator unit for a hospital, is adjacent to a non-load-bearing partition. The failure of the partition might jeopardize the motor generator unit and, therefore, the wall should be designed for a performance level sufficient to ensure its stability.

Where nonstructural wall components may affect or stiffen the structural system because of their close proximity, care must be exercised in selecting the wall materials and in designing the intersection details to ensure the desired performance of each component.

6.2.4 Flexibility. In the design and evaluation of support structures and the attachment of architectural components, flexibility should be considered. Components that are subjected to seismic relative displacements (that is, components that are connected to both the floor and ceiling level above) should be designed with adequate flexibility to accommodate imposed displacements. This is covered in Sec. 6.2.7. In the design and evaluation of equipment support structures and attachments, flexibility will reduce the fundamental frequency of the supported equipment and increase the amplitude of its induced relative motion. This lowering of the fundamental frequency of the supported component often will bring it into the range of the fundamental frequency of the supporting building or into the high energy range of the input motion. In evaluating the flexibility/stiffness of the component attachment, the effects of flexibility in the load path of the components should be considered especially in the region near the anchor points.

6.2.5 Component force transfer. It is required that components be attached to the structure and that all the required attachments be fully detailed in the design documents, or be specified in accordance with approved standards. These details should take into account the force levels and anticipated deformations expected or designed into the structure. For the purposes of the load path check, it is essential that detailed information concerning the components, including size, weight, and location of component anchors, be communicated to the registered design professional responsible for the structure during the design process.

The calculation of forces as prescribed in Sec. 6.2.6 recognizes the unique dynamic and structural characteristics of the components as compared to structures. Components typically lack the desirable attributes of structures (such as ductility, toughness, and redundancy) that permit the use of greatly reduced lateral design forces. This is reflected in the lower values for R_p given in Tables 6.3-1 and 6.4-1, as compared to R values for structures. In addition, components may exhibit unique dynamic amplification characteristics, as reflected in the values for a_p in Tables 6.3-1 and 6.4-1. Thus, for the calculation of the component integrity and connection to the supporting structure, greater forces are used, as a percentage of component mass, than are typically calculated for the overall seismic-force-resisting system. It is the intent of this provision that component forces be accommodated in the design of the structure as required to prevent local overstress of the immediate vertical and lateral load-carrying systems. Inasmuch as the component masses are included, explicitly or otherwise, in the design of the seismic-force-resisting system, it is generally sufficient for verification of a complete load path to check only for local overstress conditions in the vicinity of the component in question. One approach to achieve this is to check the capacity of the first structural element in the load path (for example, the floor beam directly under a component) for combined dead, live, operating, and seismic loads, using the horizontal and vertical loads from Sec. 6.2.6 for the seismic demand. This procedure is repeated for

each structural element or connection in the load path until the load case including horizontal and vertical loads from Sec. 6.2.6 no longer governs the design of the element. This will occur when the component design loads generated by Sec. 6.2.6 become small relative to the dead and live load demands on the structural element. Where component forces have increased due to the nature of the anchorage system, these load increases, which take the form of reductions in R_p , or increases in F_p , need not be considered in the check of the load path.

An area of concern that is often overlooked is the reinforcement and positive connection of housekeeping slabs to the supporting structure. Lack of such reinforcement and connections has led to costly failures in past earthquakes. Therefore, the housekeeping slabs must be considered as part of the continuous load path be adequately reinforced, and be positively fastened to the supporting structure.

The exact size and location of loads might not be known until the component is ordered. Therefore, the designer should make conservative assumptions in the design of the supporting structural elements. The design of the supporting structural elements must be checked once the final magnitude and location of the design loads have been established.

If an architectural component were to fail during an earthquake, the mode of failure probably would be related to faulty design of the component, interrelationship with another component that fails, interaction with the structural framing, deficiencies in its type of mounting, or inadequacy of its attachments or anchorage. The last is perhaps the most critical when considering seismic safety.

Building components designed without any intended structural function—such as infill walls—may interact with the structural framing and be forced to act structurally as a result of excessive building deformation. The build up of stress at the connecting surfaces or joints may exceed the limits of the materials. Spatial tolerances between such components thus become a governing factor. These requirements therefore emphasize the ductility and strength of the attachments for exterior wall elements and the interrelationship of elements.

Traditionally, mechanical equipment that does not include rotating or reciprocating components (such as tanks and heat exchangers) is anchored directly to the building structure. Mechanical and electrical equipment containing rotating or reciprocating components often is isolated from the structure by vibration isolators (such as rubber-in-shear, springs, or air cushions). Heavy mechanical equipment (such as large boilers) often is not restrained at all, and electrical equipment other than generators, which are normally isolated to dampen vibrations, usually is rigidly anchored (for example, switchgear and motor control centers). The installation of unattached mechanical and electrical equipment should be virtually eliminated for buildings covered by the *Provisions*.

Friction produced solely by the effects of gravity cannot be counted on to resist seismic forces as equipment and fixtures often tend to “walk” due to rocking when subjected to earthquake motions. This often is accentuated by vertical ground motions. Because such frictional resistance cannot be relied upon, positive restraint must be provided for each component.

6.2.6 Seismic forces. The design seismic force is dependent upon the weight of the system or component, the component amplification factor, the component acceleration at point of attachment to the structure, the component importance factor, and the component response modification factor.

The seismic design force equations presented originated with a study and workshop sponsored by the National Center for Earthquake Engineering Research (NCEER) with funding from the National Science Foundation (NSF) (Bachman et al., 1993). The participants examined recorded acceleration data in response to strong earthquake motions. The objective was to develop a “supportable” design force equation that considered actual earthquake data as well as component location in the structure, component anchorage ductility, component importance, component safety hazard upon separation from the structure, structural response, site conditions, and seismic zone. Additional studies have further revised the equation to its present form (Drake and Bachman, 1994 and 1995). In addition, the term C_a has been replaced by the quantity $0.4S_{DS}$ to conform to changes in Chapter 3. BSSC Technical

Subcommittee 8 believes that Eq. 6.2-1, 6.2-3, and 6.2-4 achieve the objectives without unduly burdening the practitioner with complicated formulations.

The component amplification factor (a_p) represents the dynamic amplification of the component relative to the fundamental period of the structure (T). It is recognized that at the time the components are designed or selected, the structural fundamental period is not always defined or readily available. It is also recognized that the component fundamental period (T_p) is usually only accurately obtained by expensive shake-table or pull-back tests. A listing is provided of a_p values based on the expectation that the component will usually behave in either a rigid or flexible manner. In general, if the fundamental period of the component is less than 0.06 sec, no dynamic amplification is expected. It is not the intention of the *Provisions* to preclude more accurate determination of the component amplification factor when reasonably accurate values of both the structural and component fundamental periods are available. Figure C6.2-1 is from the NCEER work and is an acceptable formulation for a_p as a function of T_p/T . Minor adjustments in the tabulated a_p values were made in the 1997 Edition to be consistent with the 1997 *Uniform Building Code*.

The component response modification factor (R_p) represents the energy absorption capability of the component's structure and attachments. Conceptually, the R_p value considers both the overstrength and deformability of the component's structure and attachments. In the absence of current research, it is believed these separate considerations can be adequately combined into a single factor. The engineering community is encouraged to address the issue and conduct research into the component response modification factor that will advance the state of the art. These values are judgmentally determined utilizing the collective wisdom and experience of the responsible committee. In general, the following benchmark values were used:

$R_p = 1.5$, low deformability element

$R_p = 2.5$, limited deformability element

$R_p = 3.5$, high deformability element

Minor adjustments in the tabulated R_p values were made in the 1997 Edition to correlate with F_p values determined in accordance with the 1997 *Uniform Building Code*. Researchers have proposed a procedure for validating values for R_p with respect to documented earthquake performance (Bachman and Drake, 1996).

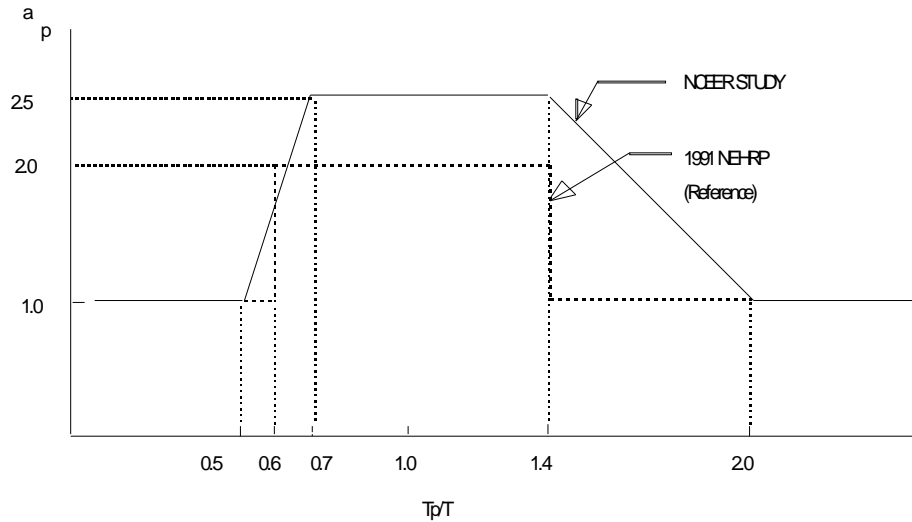

Figure C6.2-1 NCEER formulation for a_p as function of structural and component periods

Eq. 6.2-1 represents a trapezoidal distribution of floor accelerations within the structure, linearly varying from the acceleration at the ground ($0.4S_{DS}$) to the acceleration at the roof ($1.2S_{DS}$). The ground acceleration ($0.4S_{DS}$) is intended to be the same acceleration used as design input for the structure itself and includes site effects.

Examination of recorded in-structure acceleration data in response to large California earthquakes reveals that a reasonable maximum value for the roof acceleration is four times the input ground acceleration to the structure. Earlier work (Drake and Bachman, 1996, 1995 and 1996) indicated that the maximum amplification factor of four seems suitable (Figure C6.2-2). However, a close examination of recently recorded strong motion data at sites with peak ground accelerations in excess of $0.1g$ indicates that an amplification factor of three is more appropriate (Figure C6.2-3). In the lower portions of the structure (the lowest 20 percent of the structure), both the amplification factors of three and four do not bound the mean plus one standard deviation accelerations. However, the minimum design force in Eq. 6.2-4 provides a lower bound in this region.

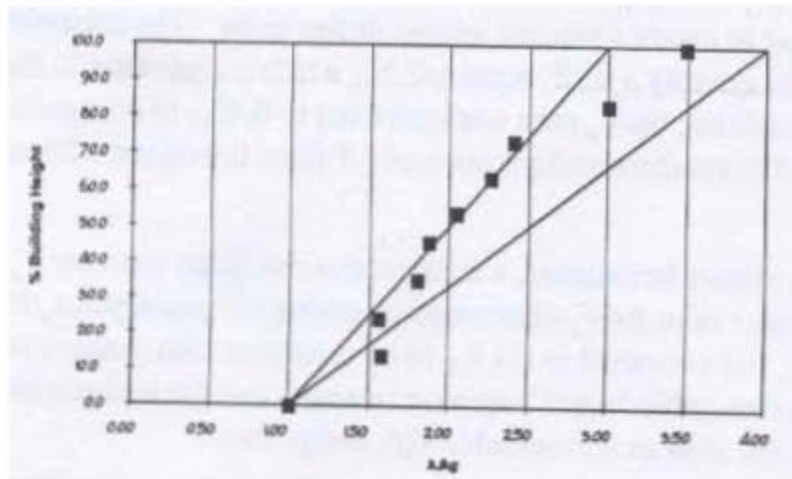

Figure C6.2-2 Revised NEHRP equation vs (Mean + 1σ) acceleration records -all sites

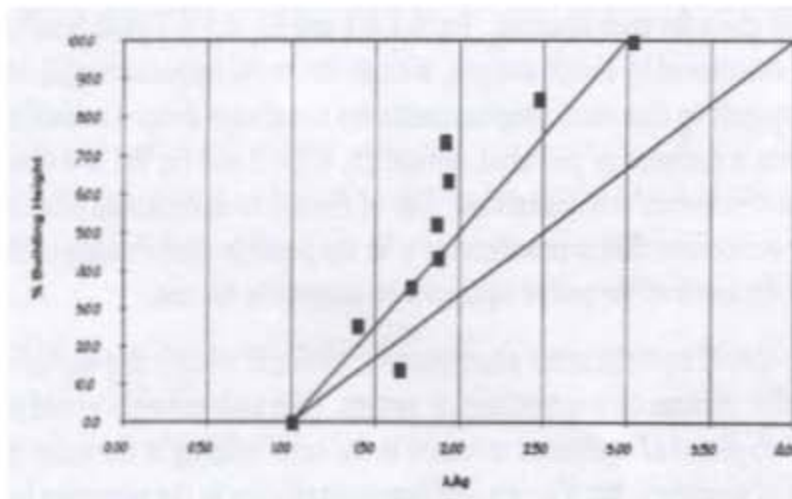

Figure C6.2-3 Revised NEHRP equation vs (Mean + 1σ) acceleration records - sites with $A_g \geq 0.1g$

At periods greater than T_s (where $T_s = S_{DI}/S_{DS}$), the acceleration response of structures ground reduces because the design ground motion acceleration response spectra beyond T_s starts to reduce by the ratio of T_s/T (where T is the fundamental period of the primary structure). Since this reduction in the design forces for the primary structure is accounted for in design force equations, it is justifiable to make a similar type of reduction in the design forces of non-structural components. However, in observing the actual in-structure response spectra of acceleration recordings measured at the roof levels of buildings with a range of fundamental periods, this reduction in response typically begins at periods about 25 percent greater than T_s . Therefore, the transition period, T_{flx} at the top of the primary structure at which forces begin reducing by a ratio of T_p/T has been lengthened by 25 percent to account for this observation. At the ground level ($z = 0$) the adjustment is 0 percent since the effect of the structure response has no influence on the non-structural component response. A linear interpolation is used between the top and bottom of the structure.

A lower limit for F_p is set to assure a minimal seismic design force. The minimum value for F_p was determined by setting the quantity $a_p A_p / R_p$ equal $0.3S_{DS}$ for consistency with current practice.

To meet the need for a simpler formulation, a conservative maximum value for F_p also was set. Eq. 6.2-3 is the maximum value for F_p determined by setting the quantity $a_p A_p / R_p$ equal to 4.0. Eq. 6.2-3 also serves as a reasonable “cutoff” equation to assure that the multiplication of the individual factors does not yield an unreasonably high design force.

To clarify the application of vertical seismic design forces in combination with horizontal design forces and service loads, a cross-reference was provided to Sec. 4.2.2. The value for F_p calculated in accordance with Chapter 6 should be substituted for the value of Q_E in Sec. 4.2.2.

For elements with points of attachment at varying heights, it is recommended that F_p be determined individually at each height (including minima) and the values averaged.

Alternatively for each point of attachment a force F_p shall be determined based on Eq. 6.2-1. Minima and maxima in Sec. 6.2.6 must be utilized in determining each F_p . The weight W_p used in determining each F_p should be based on the tributary weight of the component associated with the point of attachment. For designing the component, the attachment force F_p should be distributed relative to the component’s mass distribution over the area used to establish the tributary weight (in the instance of tilt-up walls, a uniform horizontal load would be applied half-way up the wall equal to F_p min.). With the exception of out-of-plane wall anchorage to flexible diaphragms, which is covered by Eq. 4.6-1, each anchorage force should be based on simple statistics determined using all the distributed loads applied to the complete component. Cantilever parapets that are part of a continuous element should be separately checked for parapet forces.

The seismic force on any component must be applied at the center of gravity of the component and must be assumed to act in any horizontal direction. Vertical forces on nonstructural components are specified in Sec. 6.2.6.

6.2.7 Seismic relative displacements. The seismic relative displacement equations were developed as part of the NCEER/NSF study and workshop described above. It was recognized that displacement equations were needed for use in the design of cladding, stairwells, windows, piping systems, sprinkler components, and other components that are connected to the structure(s) at multiple levels or points of connection.

Two equations are given for each situation. Eq. 6.2-5 and Eq. 6.2-7 produce “real” structural displacements as determined by elastic analysis, with no structural response modification factor (R) included. Recognizing that elastic displacements are not always defined or available at the time the component is designed or procured, default Eq. 6.2-6 and Eq. 6.2-8, which allow the use of structure drift limitations, also are provided. Use of these default equations must balance the need for a timely component design/procurement with the possible conservatism of their use. It is the intention that the lesser of the paired equations be acceptable for use.

The designer also should consider other situations where seismic relative displacements could impose unacceptable stresses on a component or system. One such example would be a component connecting two pieces of equipment mounted in the same building at the same elevation, where each piece of equipment has its own displacements relative to the mounting location. In this case, the designer must accommodate the total of the separate seismic displacements relative to the equipment mounting location. The height over which D_p , the displacement demand, must be accommodated is often less than the story height h_{sx} , and should be carefully considered. For example, a glazing system sandwiched between two rigid precast concrete spandrel panels may need to accommodate the entire displacement demand in less than 1/3 of the story height. Similar demands can occur when pipes, ducts and conduit that are connected to the top of a tall component are braced to the floor or roof above.

For some items, such as ductile piping, relative seismic displacements between support points generally are of more significance than forces. Piping made of ductile materials such as steel or copper can accommodate relative displacements by local yielding but with strain accumulations well below failure levels. However, components made of less ductile materials can only accommodate relative

displacement effects by use of flexible connections, avoiding local yielding. Further, it is the intent of the *Provisions* to consider the effects of seismic support relative displacements and displacements caused by seismic forces on mechanical and electrical component assemblies such as piping systems, cable and conduit systems, and other linear systems, and the equipment to which they attach. Impact of components should also be avoided although ductile materials have been shown to be capable of accommodating fairly significant impact loads. With protective coverings, ductile mechanical and electrical components and many more fragile components can be expected to survive all but the most severe impact loads.

6.2.8 Component anchorage. Depending on the specifics of the design condition, ductile design of anchors in concrete or masonry may be intended to satisfy one or all of the following objectives: (1) to ensure adequate load redistribution between anchors in a group, (2) to allow for anchor overload without precipitous failure, and/or (3) to dissipate seismic energy. Unless specific attention is paid to the conditions necessary to ensure the desired hysteretic response (adequate gauge length, anchor spacing, edge distance, steel properties, etc.), it is not recommended that anchors be relied upon for energy dissipation. Inasmuch as the anchor provides the transfer of load from a relatively deformable material (such as steel) to a low deformability material (such as concrete or masonry), achieving deformable, energy-absorbing behavior in the anchor itself is often difficult. On the other hand, the concept of providing a fuse, or deformable link, in the load path to the anchor is encouraged. This approach allows the designer to provide the necessary level of ductility and overstrength in the connection while at the same time protecting the anchor from overload and eliminates the need to balance steel strength and deformability in the anchor with variable edge distances and anchor spacings.

Previous restrictions on the anchor l/d ratio as a means of defining ductile vs. non-ductile anchors have been deleted from the *Provisions* in recognition of the difficulty in defining the conditions necessary for real ductile behavior. For example, a single anchor with the necessary embedment to force ductile failure of the anchor bolt in tension may still experience concrete fracture (a non-ductile failure mode) if the edge distance is small, if the anchor is placed in a group of tension-loaded anchors with reduced spacing, or if the anchor is loaded in shear instead of tension. In fact, many if not most anchor applications, such as building cladding attachments and large equipment anchorages, are subject primarily to shear loading. In these cases, even if the anchor steel is ductile, shear failure of the bolt may be non-ductile, particularly if the deformation of the anchor is constrained by rigid elements on either side of the joint. It is therefore left to the designer to establish the necessary criteria for ductile anchor failure.

Post-installed expansion and undercut anchors may now be qualified as suitable for seismic applications using the testing procedures outlined in ACI 355.2-01, *Evaluating the Performance of Post-Installed Mechanical Anchors in Concrete (355.2-01)* and *Commentary (355.2R-01)*. The design of qualified anchors in concrete is addressed in Sec. 9.6 of the *Provisions*. No such standard exists as yet for chemical anchors, and caution should be exercised in their use in earthquake environments, particularly with respect to the effects of earthquake-induced cracking of the concrete or masonry on anchor capacity. The capacity of anchors in masonry is rarely governed by steel capacity, and as such masonry anchors should in general be considered to be non-ductile. For this reason, the design of anchors in masonry should be carried out with an R_p of 1.5.

For purposes of the *Provisions*, a chemical anchor is a post-installed anchor rod, usually steel, which is inserted into a drilled hole in concrete or masonry together with a polymer or cementitious grout and which derives its tension capacity primarily from bond. On the other hand, reference to adhesives is intended to include steel plates and other structural elements adhered to the surface of another structural component with adhesive. An example of this type of application is the attachment of computer access floors base plates to a floor slab with epoxy. This type of connection is typically non-ductile.

Allowable loads for anchors should not be increased for earthquake loading. Possible reductions in allowable loads for particular anchor types to account for loss of stiffness and strength should be determined by means of appropriate dynamic testing.

Anchors that are used to support towers, masts, and equipment often are provided with double nuts to allow for leveling during installation. Where baseplate grout is provided at such double-nutted anchors, it should not be relied upon to carry loads since it can shrink and crack or is often omitted altogether. In this case, the anchors are loaded in tension, compression, shear, and flexure and should be designed accordingly. Prying forces on anchors, which result from a lack of rotational stiffness in the connected part, can be critical for anchor design and must be considered explicitly.

For anchorages that are not provided with a mechanism to transfer compression loads, the design for overturning must reflect the actual stiffness of the baseplate, equipment, housing, etc., in determining the location of the compression centroid and the distribution of uplift loads to the anchors.

Possible reductions in allowable loads for particular anchor types to account for loss of stiffness and strength should be determined through appropriate dynamic testing.

While the requirements do not prohibit the use of single anchor connections, it is considered good practice to use at least two anchors in any load-carrying connection whose failure might lead to collapse, partial collapse, or disruption of a critical inertial load path.

Tests have shown that there are consistent shear ductility variations between bolts anchored to drilled or punched plates with nuts and connections using welded, shear studs. Recommendations for design are not presently available but this issue should be considered in critical connections subject to dynamic or seismic loading.

It is important to relate the anchorage demands defined by Chapter 6 with the material capacities defined in the other chapters (e.g., Chapters 9 and 11).

6.2.8.5 Power-actuated fasteners. Generally, power-actuated fasteners in concrete tend to exhibit variations in load capacity that are somewhat larger than post-installed drilled anchors. Therefore, the suitability of power-actuated fasteners should be demonstrated by a simulated seismic test program prior to their use. When properly installed in steel, such fasteners are reliable, showing high capacities with very low variability.

6.2.9 Construction documents. The committee believes that each quality assurance activity specified in Chapter 2 should have a clearly defined basis. As a result, construction documents are required for all components for which Chapter 2 requires special inspection or testing.

The committee believes that, in order to provide a reasonable level of assurance that the construction and installation of components is consistent with the basis of the supporting seismic design, appropriate construction documents are needed. Of particular concern are systems involving multiple trades and suppliers. In these cases, it is important that a registered design professional prepare construction documents for use by the various trades and suppliers in the course of construction.

6.3 ARCHITECTURAL COMPONENTS

The requirements of Sec. 6.3 are intended to reduce the threat of life safety hazards posed by components and elements from the standpoint of stability and integrity. There are several circumstances where such components may pose a threat.

1. Where loss of integrity and/or connection failure under seismic motion poses a direct hazard in that the components may fall on building occupants.
2. Where loss of integrity and/or connection failure may result in a hazard for people outside of a building because components such as exterior cladding and glazing may fall on them.
3. Where failure or upset of interior components may impede access to a required exit.

The requirements are intended to apply to all of the circumstances listed above. Although the safety hazard posed by exterior cladding is obvious, judgment may be needed in assessing the extent to which the requirements should be applied to other hazards.

Property loss through damage to architectural components is not specifically addressed in the *Provisions*. Function and operation of a building also may be affected by damage to architectural components if it is necessary to cease operations while repairs are undertaken. In general, requirements to improve life-safety also will reduce property loss and loss of building function.

In general, functional loss is more likely to be affected by loss of mechanical or electrical components. Architectural damage, unless very severe, usually can be accommodated on a temporary basis. Very severe architectural damage results from excessive structural response that often also results in significant structural damage and building evacuation.

6.3.1 Forces and displacements. Components that could be damaged by or could damage other components and are fastened at multiple locations to a structure should be designed to accommodate seismic relative displacements. Such components include glazing, partitions, stairs, and veneers.

Certain types of veneer elements, such as aluminum or vinyl siding and trim, possess high deformability. These systems are generally light and can undergo large deformations without separating from the structure. However, care must be taken when designing these elements to ensure that the low deformability components that may be part of the curtain wall system, such as glazing panels, have been detailed to accommodate the expected deformations without failure.

Specific requirements for cladding are provided. Glazing, both exterior and interior, and partitions must be capable of accommodating story drift without causing a life-safety hazard. Design judgment must be used with respect to the assessment of life-safety hazard and the likelihood of life-threatening damage. Special detailing to accommodate drift for typical replaceable gypsum board or demountable partitions is not likely to be cost-effective, and damage to these components poses a low hazard to life safety. Nonstructural fire-resistant enclosures and fire-rated partitions may require some special detailing to ensure that they retain their integrity. Special detailing should provide isolation from the adjacent or enclosing structure for deformation equivalent to the calculated drift (relative displacement). In-plane differential movement between structure and wall is permitted. Provision also must be made for out-of-plane restraint. These requirements are particularly important in relation to the larger drifts experienced in steel or concrete moment frame structures. The problem is less likely to be encountered in stiff structures, such as those with shear walls.

Differential vertical movement between horizontal cantilevers in adjacent stories (such as cantilevered floor slabs) has occurred in past earthquakes. The possibility of such effects should be considered in the design of exterior walls.

6.3.2 Exterior nonstructural wall elements and connections. The *Provisions* requires that nonbearing wall panels that are attached to or enclose the structure be designed to resist the (inertial) forces and to accommodate movements of the structure resulting from lateral forces or temperature change. The force requirements often overshadow the importance of allowing thermal movement and may therefore require special detailing in order to prevent moisture penetration and allow thermal movements.

Connections should be designed so as to prevent the loss of load-carrying capacity in the event of significant yielding. Between points of connection, panels should be separated from the structure sufficiently to avoid contact due to seismic action.

The *Provisions* requires allowance for story drift. This required allowance can amount to 2 in. (50 mm) or more from one floor to the next and may present a greater challenge to the designer than requirements for the forces. In practice, separations between adjacent panels, intended to limit contact and resulting panel mis-alignment and/or damage under all but extreme building response, are limited to about 3/4 in.

(19 mm) for practical joint detailing with acceptable appearance. The *Provisions* calls for a minimum separation of 1/2 in. (13 mm). The design should be consistent with the manufacturing and construction tolerances of the materials used to achieve this dimension.

If wind loads govern, connectors and panels should allow for not less than two times the story drift caused by wind loads determined using a return period appropriate to the site location.

The *Provisions* requirements are in anticipation of frame yielding to absorb energy. Appropriate isolation can be achieved by means of slots, but the use of long rods that flex is preferable because this approach does not depend on precise installation to achieve the desired action. The rods must be designed to carry tension and compression in addition to induced flexural stresses. Care must be used in allowing inelastic bending in the rods. Threaded rods pushed into the strain-hardening region of the stress-strain curve are subject to brittle low-cycle fatigue failures. Floor-to-floor wall panels are usually rigidly attached to and move with the floor structure nearest the panel bottom. In this condition, isolation connections are used at the upper attachments so that panels translate with the load supporting structure below and are not subjected to large in-plane forces due to movement of the building. Panels also can be supported at the top with isolation connections at the bottom.

When determining the length of slot or displacement demand for the connection, the cumulative effect of tolerances in the supporting frame and cladding panel must be considered.

To minimize the effects of thermal movements and shrinkage on architectural cladding panels, the connection system is generally detailed to be statically determinate. As a result, cladding panel support systems often lack redundancy and failure of a single connection can have catastrophic consequences. In recognition of this, the *Provisions* require that fasteners be designed for approximately 4 times the required panel force and that the connecting member be ductile. This is intended to ensure that the energy absorption takes place in the connecting member and not at the connection itself and that the more brittle fasteners remain essentially elastic under seismic loading. The factor of 4 has been incorporated into the a_p and R_p factors in consideration of installation and material variability and the consequences of a brittle connection failure in a statically determinate system.

6.3.3 Out-of-plane bending. Most walls are subject to out-of-plane forces when a building is shaken by an earthquake. These forces and the bending they induce must be considered in the design of wall panels, nonstructural walls, and partitions. This is particularly important for systems composed of brittle materials or materials with low flexural strength. The conventional limits based upon deflections as a proportion of the span may be used with the applied force as derived in Sec. 6.2.6.

Judgment must be used in assessing the deflection capability of the component. The intent is that a heavy material (such as concrete block) or an applied finish (such as brittle heavy stone or tile) should not fail in a hazardous manner as a result of out-of-plane forces. Deflection in itself is not a hazard. A steel-stud partition might undergo considerable deflection without creating a hazard; but if the same partition supports a marble facing, a hazard might exist and special detailing may be necessary.

6.3.4 Suspended ceilings. Suspended ceiling systems usually are fabricated using a wide range of building materials with individual components having different material characteristics. Some systems are homogeneous whereas others incorporate suspension systems with acoustic tile or lay-in panels. Seismic performance during recent, large earthquakes in California has raised two concerns:

1. Support of the individual panels at walls and expansion joints, and
2. Interaction with fire sprinkler systems.

In an attempt to address these concerns, alternate methods were developed in a cooperative effort by representatives of the ceiling and fire sprinkler industries and registered design professionals. It is hoped that future research and investigation will result in further improvements in the *Provisions*.

Consideration must be given to the placement of seismic bracing, the relation of light fixtures and other loads placed into the ceiling diaphragm, and the independent bracing of partitions in order to effectively maintain the performance characteristics of the ceiling system. The ceiling system may require bracing and allowance for the interaction of components.

Dynamic testing of suspended ceiling systems constructed according to the requirements of current industry seismic standards (*UBC Standard 25-2*) performed by ANCO Engineers, Inc. (1983) has demonstrated that the splayed wires, even with the vertical compression struts, may not adequately limit lateral motion of the ceiling system due to the flexibility introduced by the straightening of the wire end loops. In addition, splay wires usually are installed slack to prevent unleveling of the ceiling grid and to avoid above-ceiling utilities. Not infrequently, bracing wires are omitted because of obstructions. Testing also has shown that system performance without splayed wires or struts was good if sufficient clearance is provided at penetrations and closure angles are wide enough.

The lateral seismic restraint for a non-rigidly braced suspended ceiling is primarily provided by the ceiling coming into contact with the perimeter wall. The wall provides a large contact surface to restrain the ceiling. The key to good seismic performance is that the width of the closure angle around the perimeter is adequate to accommodate ceiling motion and that penetrations, such as columns and piping, have adequate clearance to avoid concentrating restraining loads on the ceiling system. The behavior of an unbraced ceiling system is similar to that of a pendulum; therefore, the lateral displacement is approximately proportional to the level of velocity-controlled ground motion and the square root of the suspension length. Therefore, a new section has been added that permits exemption from force calculations if certain displacement criteria are met. The default displacement limit has been determined based on anticipated damping and energy absorption of the suspended ceiling system assuming minimal significant impact with the perimeter wall.

6.3.5 Access floors. Performance of computer access floors during past earthquakes and during cyclic load tests indicate that typical raised access floor systems may behave in a brittle manner and may exhibit little reserve capacity beyond initial yielding or failure of critical connections. Recent testing indicates that individual panels may “pop out” of the supporting grid during seismic motions. Consideration should be given to mechanically fastening the individual panels to the supporting pedestals or stringers in egress pathways.

For systems with floor stringers, it is acceptable practice to calculate the seismic force, F_p , for the entire access floor system within a partitioned space and then distribute the total force to the individual braces or pedestals. Stringerless systems need to be evaluated very carefully to ensure a viable seismic load path.

Overtuning effects for the design of individual pedestals is a concern. Each pedestal usually is specified to carry an ultimate design vertical load greatly in excess of the W_p used in determining the seismic force F_p . It is non-conservative to use the design vertical load simultaneously with the design seismic force when considering anchor bolts, pedestal bending, and pedestal welds to base plates. The maximum concurrent vertical load when considering overturning effects is therefore limited to the value of W_p used in determining F_p . “Slip on” heads are not mechanically fastened to the pedestal shaft and provide doubtful capacity to transfer overturning moments from the floor panels or stringers to the pedestal.

To preclude brittle failure, each element in the seismic load path must demonstrate the capacity for elastic or inelastic energy absorption. Buckling failure modes also must be prevented. Lesser seismic force requirements are deemed appropriate for access floors designed to preclude brittle and buckling failure modes.

6.3.6 Partitions. Partitions are sometimes designed to run only from floor to a suspended ceiling which provides doubtful lateral support. Partitions subject to these requirements must have independent

lateral support bracing from the top of the partition to the building structure or to a substructure attached to the building structure.

6.3.7 Glass in glazed curtain walls, glazed storefronts, and glazed partitions. Glass performance in earthquakes can fall into one of four categories:

1. The glass remains unbroken in its frame or anchorage.
2. The glass cracks but remains in its frame or anchorage while continuing to provide a weather barrier, and to be otherwise serviceable.
3. The glass shatters but remains in its frame or anchorage in a precarious condition, likely to fall out at any time.
4. The glass falls out of its frame or anchorage, either in fragments, shards, or whole panels.

Categories 1. and 2. provide both life safety and immediate occupancy levels of performance. In the case of category 2., even though the glass is cracked, it continues to provide a weather enclosure and barrier, and its replacement can be planned over a period of time. (Such glass replacement need not be performed in the immediate aftermath of the earthquake.) Categories 3. and 4. cannot provide for immediate occupancy, and their provision of a life safety level of performance depends on the post-breakage characteristics of the glass and the height from which it can fall. Tempered glass shatters into multiple, pebble-size fragments that fall from the frame or anchorage in clusters. These broken glass clusters are relatively harmless to humans when they fall from limited heights, but when they fall from greater heights they could be harmful.

The requirement that $\Delta_{fallout}$ not be less than $1.25ID_P$ is derived from *Earthquake Safety Design of Windows*, published in November 1982 by the Sheet Glass Association of Japan. Eq. 6.3-1 is based on a similar equation in Bouwkamp and Meehan (1960) that permits calculation of the story drift required to cause glass-to-frame contact in a given rectangular window frame. Both calculations are based on the principle that a rectangular window frame (specifically, one that is anchored mechanically to adjacent stories of the primary structural system of the building) becomes a parallelogram as a result of story drift, and that glass-to-frame contact occurs when the length of the shorter diagonal of the parallelogram is equal to the diagonal of the glass panel itself.

The 1.25 factor in the requirements described above reflect uncertainties associated with calculated inelastic seismic displacements in building structures. Wright (1989) stated that “post-elastic deformations, calculated using the structural analysis process, may well underestimate the actual building deformation by up to 30 percent. It would therefore be reasonable to require the curtain wall glazing system to withstand 1.25 times the computed maximum interstory displacement to verify adequate performance.” Therefore, Wright’s comments form the basis for employing the 1.25 factor in these requirements.

Introduction. Seismic design requirements for glass in building codes have traditionally been non-existent or have been limited to the general statement that “drift be accommodated.” No distinction has been made regarding the seismic performance of different types of glass, different frames, and different glazing systems. Yet, significant differences exist in the performance of various glass types subjected to simulated earthquake conditions. Controlled laboratory studies were conducted to investigate the cracking resistance and fallout resistance of different types of glass installed in the same storefront and mid-rise wall systems. Effects of glass surface prestress, lamination, wall system type, and dry versus structural silicone glazing were considered. Laboratory results revealed that distinct magnitudes of story drift cause glass cracking and glass fallout in each glass type tested. Notable differences in seismic resistance exist between glass types commonly used in contemporary building design.

Test rig and experimental plan. In-plane dynamic racking tests were performed using the rig shown in Figure C6.3-1. Rectangular steel tubes at the top and bottom of the facility are supported on roller assemblies, which permit only horizontal motion of the tubes. The bottom steel tube is driven by a

computer-controlled hydraulic ram, while the top tube is attached to the bottom tube by means of a fulcrum and pivot arm assembly. This mechanism causes the upper steel tube to displace the same amount as the lower steel tube, but in the opposite direction, which doubles the amount of story drift that can be imposed on a test specimen from ± 76 mm (± 3 in.) to ± 152 mm (± 6 in.). The test facility accommodated up to three glass test panels, each 1.5 m (5 ft) wide by 1.8 m (6 ft) high. A more detailed description of the dynamic racking test rig is included in Behr and Belarbi (1996).

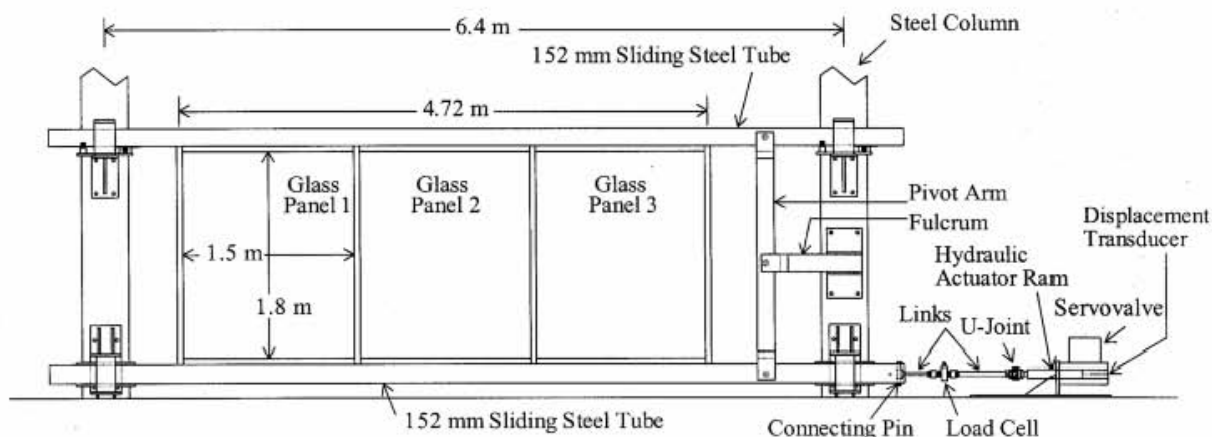

Figure C6.3-1 Dynamic racking test rig.

Several types of glass, shown in Table C6.3-1, were tested under simulated seismic conditions in the storefront and mid-rise dynamic racking tests. These glass types, along with the wall systems employed in the tests, were selected after polling industry practitioners and wall system designers for their opinions regarding common glass types and common wall system types employed in contemporary storefront and mid-rise wall constructions.

Storefront wall system tests. Tests were conducted on various glass types that were dry-glazed within a wall system, as commonly used in storefront applications. Loading histories for the storefront wall system tests were based on dynamic analyses performed on a “typical” storefront building that was not designed specifically for seismic resistance (Pantelides et al., 1996). Two types of tests were conducted on the storefront wall systems: (1) serviceability tests, wherein the drift loading history of the glass simulated the response of a storefront building structure to a “maximum probable” earthquake event; and (2) ultimate tests, wherein drift amplitudes were twice those of the serviceability tests, which was a simplified means of approximating the loading history of a “maximum credible” earthquake event. As indicated in Table C6.3-1, five glass types were tested, all dry-glazed in a storefront wall system. Three glass panels were mounted side by side in the test facility, after which horizontal (in-plane) racking motions were applied.

Table C6.3-1 Glass Types Included in Storefront and Mid-Rise Dynamic Racking Tests

Glass Type	Storefront Tests	Mid-Rise Tests
6 mm (1/4 in.) annealed monolithic	✓	✓
6 mm (1/4 in.) heat-strengthened monolithic		✓
6 mm (1/4 in.) fully tempered monolithic	✓	✓

6 mm (1/4 in.) annealed monolithic with 0.1 mm pet film (film not anchored to wall system frame)		✓
6 mm (1/4 in.) annealed laminated	✓	✓
6 mm (1/4 in.) heat-strengthened laminated		✓
6 mm (1/4 in.) heat-strengthened monolithic spandrel		✓
25 mm (1 in.) annealed insulating glass units	✓	✓
25 mm (1 in.) heat-strengthened insulating glass units		✓

The serviceability test lasted approximately 55 seconds and incorporated drift amplitudes ranging from ± 6 to ± 44 mm (± 0.25 to ± 1.75 in.). The drift pattern in the ultimate test was formed by doubling each drift amplitude in the serviceability test. Both tests were performed at a nominal frequency of 0.8 Hz.

Experimental results indicated that for all glass types tested, serviceability limit states associated with glass edge damage and gasket seal degradation in the storefront wall system were exceeded during the moderate earthquake simulation (that is, the serviceability test). Ultimate limit states associated with major cracking and glass fallout were reached for the most common storefront glass type, 6 mm (1/4 in.) annealed monolithic glass, during the severe earthquake simulation (that is, the ultimate test). This observation is consistent with a reconnaissance report of damage resulting from the Northridge Earthquake (EERI, 1994). More information regarding the storefront wall system tests is included in Behr, Belarbi, and Brown (1995). In addition to the serviceability and ultimate tests, increasing-amplitude “crescendo tests,” similar to those described below for the mid-rise tests, were performed at a frequency of 0.8 Hz on selected storefront glass types. Results of these crescendo tests are reported in Behr, Belarbi, and Brown (1995) and are included in some of the comparisons made below.

Mid-rise curtain wall system tests. Another series of tests focused on the behavior of glass panels in a popular curtain wall system for mid-rise buildings. All mid-rise glass types in Table C6.3-1 were tested with a dry-glazed wall system that uses polymeric (rubber) gaskets wedged between the glass edges and the curtain wall frame to secure each glass panel perimeter. In addition, three glass types were tested with a bead of structural silicone sealant on the vertical glass edges and dry glazing gaskets on the horizontal edges (that is, a “two-side structural silicone glazing system”). Six specimens of each glass type were tested.

Crescendo tests were performed on all mid-rise test specimens. As described by Behr and Belarbi (1996), the crescendo test consisted of a series of alternating “ramp-up” and “constant amplitude” intervals, each containing four sinusoidal-shaped drift cycles. Each drift amplitude “step” (that is, the increase in amplitude between adjacent constant amplitude intervals, which was achieved by completing the four cycles in the intermediary ramp-up interval) was ± 6 mm (± 0.25 in.). The entire crescendo test sequence lasted approximately 230 seconds. Crescendo tests on mid-rise glass specimens were conducted at 1.0 Hz for dynamic racking amplitudes from 0 to 114 mm (0 to 4.5 in.), 0.8 Hz for amplitudes from 114 to 140 mm (4.5 to 5.5 in.), and 0.5 Hz for amplitudes from 140 to 152 mm (5.5 to 6 in.). These frequency reductions at higher racking amplitudes were necessary to avoid exceeding the capacity of the hydraulic actuator ram in the dynamic racking test rig.

The drift magnitude at which glass cracking was first observed was called the “serviceability drift limit,” which corresponds to the drift magnitude at which glass damage would necessitate glass replacement. The drift magnitude at which glass fallout occurred was called the “ultimate drift limit,” which corresponds to the drift magnitude at which glass damage would become a life safety hazard. This ultimate drift limit for architectural glass is related to “ $A_{fallout}$ ” in Sec. 6.3.7 of the *Provisions*, noting that horizontal racking displacements (drifts) in the crescendo tests were typically applied to test specimens having panel heights of only 1.8 m (6 ft).

In addition to recording the serviceability drift limit and ultimate drift limit for each glass test specimen, the drift magnitude causing first contact between the glass panel and the aluminum frame was also recorded. To establish when this contact occurred, thin copper wires were attached to each corner of the glass panel and were connected to an electronics box. If the copper wire came into contact with the aluminum frame, an indicator light on an electronics box was actuated. Measured drifts causing glass-to-aluminum contact correlated well with those predicted by Eq. 6.3-1.

Glass failure patterns from crescendo tests. Glass failure patterns were recorded during each storefront test and mid-rise test. Annealed monolithic glass tended to fracture into sizable shards, which then fell from the curtain wall frame. Heat-strengthened monolithic glass generally broke into smaller shards than annealed monolithic glass, with the average shard size being inversely proportional to the magnitude of surface compressive prestress in the glass. Fully tempered monolithic glass shattered into much smaller, cube-shaped fragments. Annealed monolithic glass with unanchored 0.1 mm (4 mil) PET film also fractured into large shards, much like un-filmed annealed monolithic glass, but the shards adhered to the film. However, when the weight of the glass shards became excessive, the entire shard/film conglomeration sometimes fell from the glazing pocket as a unit. Thus, unanchored 0.1 mm PET film was not observed to be totally effective in terms of preventing glass fallout under simulated seismic loadings, which agrees with field observations made in the aftermath of the 1994 Northridge Earthquake (Gates and McGavin, 1998). Annealed and heat-strengthened laminated glass units experienced fracture on each glass ply separately, which permitted these laminated glass units to retain sufficient rigidity to remain in the glazing pocket after one (or even both), glass plies had fractured due to glass-to-aluminum contacts. Annealed and heat-strengthened laminated glass units exhibited the highest resistance to glass fallout during the dynamic racking tests.

Quantitative drift limit data from crescendo tests. Serviceability and ultimate drift limit data obtained during the crescendo tests are presented in four panels in Figure C6.3-2. Figure C6.3-2a shows the effects of glass surface prestress (that is, annealed, heat-strengthened and fully tempered glass) on seismic drift limits; Figure C6.3-2b shows the effects of lamination (that is, monolithic glass, monolithic glass with unanchored 0.1 mm PET film, and laminated glass); Figure C6.3-2c shows the effects of wall system type (that is, lighter, more flexible, storefront wall system versus the same glass types tested in a heavier, stiffer, mid-rise wall system); and Figure C6.3-2d shows the effects of structural silicone glazing (that is, dry glazing versus two-side structural silicone glazing). Each symbol plotted in Figure C6.3-2 is the mean value for specimens of a given glass type, along with \pm one standard deviation error bars. In those cases where error bars for a particular glass type overlap, only one side of the error bar is plotted. In cases where the glass panel did not experience fallout by the end of the crescendo test, a conservative ultimate drift limit magnitude of 152 mm (6 in.) (the racking limit of the test facility) is assigned for plotting purposes in Figure C6.3-2. (This ultimate drift limit, shown with a “▼” symbol in Figure C6.3-2, is related to the term “ $A_{fallout}$ ” in Sec. 6.3.7 of the *Provisions*.) No error bars are plotted for these “pseudo data points,” since the drift magnitude at which the glass panel would actually have experienced fallout could not be observed; certainly, the actual ultimate drift limits for these specimens are greater than ± 152 mm (± 6 in.).

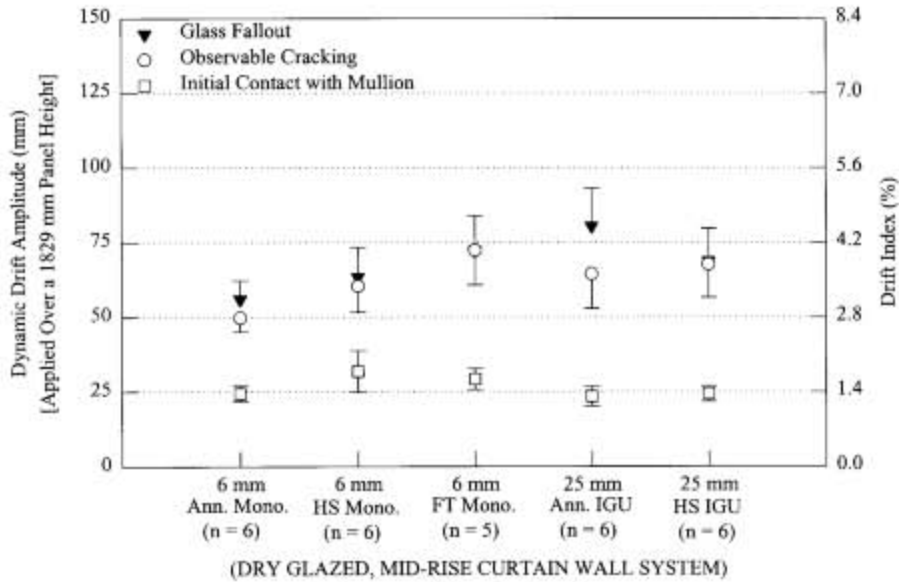

(a) Effects of Glass Surface Prestress

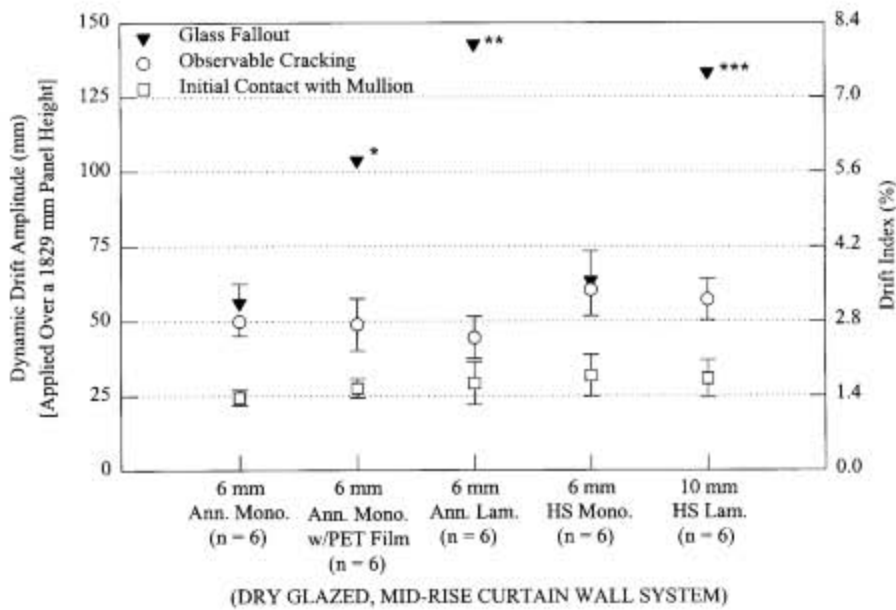

*1 of 6 specimens did not fall out. **5 of 6 specimens did not fall out. ***2 of 6 specimens did not fall out.

(b) Effects of Lamination

Figure C6.3-2 Seismic drift limits from crescendo tests on architectural glass

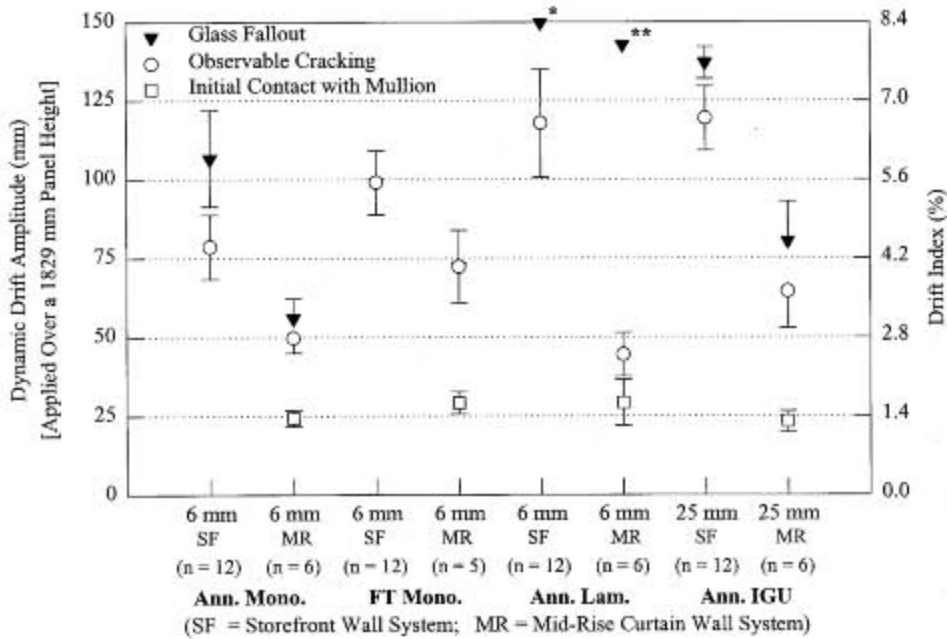

*8 of 12 specimens did not fall out. **5 of 6 specimens did not fall out.

(c) Effects of Wall System Type

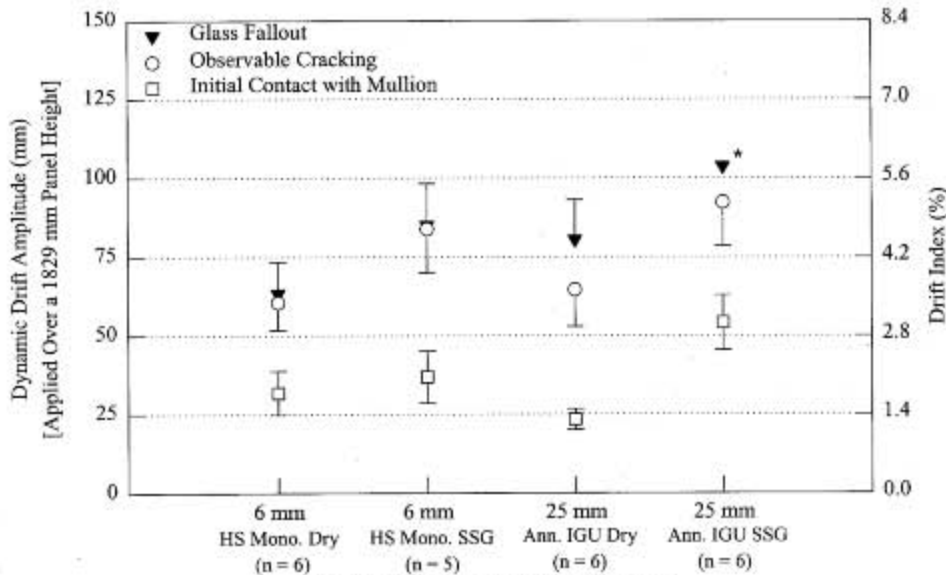

*1 of 6 specimens did not fall out.

(d) Effects of Structural Silicone Glazing

Figure C6.3-2 (continued) Seismic drift limits from crescendo tests on architectural glass

The ±152 mm (± 6 in.) racking limit of the test rig, when applied over the 1829 mm (72 in.) height of glazing panel specimens represents a severe story drift index of more than 8 percent. This 8 percent

drift index exceeds, by a significant margin, provisions in Sec. 4.5.1 (Table 4.5-1) that set allowable drift limits between 0.7 percent and 2.5 percent, depending on structure type and Seismic Use Group. Thus, the drift limits, Δ_a , in Table 4.5-1 are considerably lower than the racking limits of the laboratory facility used for the crescendo tests. In building design, however, values of $\Delta_{fallout}$ would need to be significantly higher than the story drifts exhibited by the primary building structure in order to provide an acceptable safety margin against glass fallout.

Summary observations from Figure C6.3-2. Effects of glass surface prestress - Figure C6.3-2a illustrates the effects of glass surface prestress on observed seismic drift limits. To eliminate all variables except for glass surface prestress, data from only the mid-rise curtain wall tests are plotted. Slight increases in cracking and fallout drift limits can be seen for 6 mm (0.25 in.) monolithic glass as the level of glass surface prestress increases from annealed to heat-strengthened to fully tempered glass. However, effects of glass surface prestress on observed seismic drift limits were statistically significant only when comparing 6 mm fully tempered monolithic glass to 6 mm annealed monolithic glass. All six of the 6 mm fully tempered monolithic glass specimens shattered when initial cracking occurred, causing the entire glass panels to fall out. Similar behavior was observed in four of the six 6 mm heat-strengthened monolithic glass specimens. No appreciable differences in seismic drift limits existed between annealed and heat-strengthened 25 mm (1 in.) insulating glass units.

Effects of lamination -- Figure C6.3-2b shows the effects of lamination configuration on seismic drift limits. Lamination had no appreciable effect on the drift magnitudes associated with first observable glass cracking. In a dry-glazed system, the base glass type (and not the lamination configuration) appeared to control the drift magnitude associated with glass cracking. However, lamination configuration had a pronounced effect on glass fallout resistance (that is, $\Delta_{fallout}$). Specifically, monolithic glass types were more prone to glass fallout than were either annealed monolithic glass with unanchored 0.1 mm PET film or annealed laminated glass. All six annealed monolithic glass panels experienced glass fallout during the tests; five of six annealed monolithic glass specimens with unanchored 0.1 mm PET film experienced fallout; only one of six annealed laminated glass panels experienced fallout.

Laboratory tests also showed that heat-strengthened laminated glass had higher fallout resistance than did heat-strengthened monolithic glass. Heat-strengthened monolithic glass panels fell out at significantly lower drift magnitudes than did heat-strengthened laminated glass units. Heat-strengthened laminated glass units tended to fall out in one large piece, instead of exhibiting the smaller shard fallout behavior of heat-strengthened monolithic glass.

Effects of wall system type -- Figure C6.3-2c illustrates the effects of wall system type on observed seismic drift limits. For all four glass types tested in both the storefront and mid-rise wall systems, the lighter, more flexible storefront frames allowed larger drift magnitudes before glass cracking or glass fallout than did the heavier, stiffer mid-rise curtain wall frames. This observation held true for all glass types tested in both wall system types.

Effects of structural silicone glazing -- As shown in Figure C6.3-2d, use of a two-side structural silicone glazing system increased the dynamic drift magnitudes associated with first observable glass cracking in both heat-strengthened monolithic glass and annealed insulating glass units. During the crescendo tests, glass panels were observed to “walk” horizontally across the frame after the beads of structural silicone sealant had sheared. Because the mid-rise curtain wall crescendo tests were performed on single glass panels, the glass specimen was unobstructed as it walked horizontally across the frame. In a multi-panel curtain wall assembly on an actual building, adjacent glass panels could collide, which could induce glass cracking at lower drift magnitudes than those observed in the single-panel tests performed in this study. It is also clear from Figure C6.3-2d that glass specimens with two-side structural silicone glazing exhibited higher resistance to glass fallout than did comparable dry-glazed glass specimens.

Conclusion. Dynamic racking tests showed that distinct and repeatable dynamic drift magnitudes were associated with glass cracking and glass fallout in various types of glass tested in storefront and mid-rise

wall systems. Seismic resistance varied widely between glass types commonly employed in contemporary building design. Annealed and heat-strengthened laminated glass types exhibited higher resistance to glass fallout than did monolithic glass types. Annealed monolithic glass with unanchored 0.1 mm PET film exhibited total fallout of the glass shard/adhesive film conglomeration in five out of six of the crescendo tests performed.

Glass panels glazed within stiffer aluminum frames were less tolerant of glass-to-aluminum collisions and were associated with glass fallout events at lower drift magnitudes than were the same glass types tested in a more flexible aluminum frame. Glazing details were also found to have significant effects on the seismic performance of architectural glass. Specifically, architectural glass within a wall system using a structural silicone glaze on two sides exhibited higher seismic resistance than did identical glass specimens dry-glazed on all four sides within a comparable wall framing system.

6.4 MECHANICAL AND ELECTRICAL COMPONENTS

The primary focus of these requirements is on the design of attachments and equipment supports for mechanical and electrical components.

The requirements are intended to reduce the hazard to life posed by the loss of component structural stability or integrity. The requirements should increase the reliability of component operation but do not directly address the assurance of functionality. For critical components where operability is vital, the requirements of Sec. 2.4.5 provide methods for seismically qualifying the component.

The design of mechanical and electrical components must consider two levels of earthquake safety. For the first safety level, failure of the mechanical or electrical component itself poses no significant hazard. In this case, the only hazard posed by the component is if the support and the means by which the component and its supports are attached to the building or the ground fails and the component could slide, topple, fall, or otherwise move in a manner that creates a hazard for persons nearby. In the first category, the intent of these requirements is only to design the support and the means by which the component is attached to the structure, defined in the Definitions as “supports” and “attachments.” For the second safety level, failure of the mechanical or electrical equipment itself poses a significant hazard. This could be a case either of failure of a containment having hazardous contents or contents required after the earthquake or of functional failure of a component required to remain operable after an earthquake. In this second category, the intent of these requirements is to provide guidance for the design of the component as well as the means by which the component is supported and attached to the structure. The requirements should increase the survivability of this second category of component but the assurance of functionality may require additional considerations.

Examples of this second category include fire protection piping or an uninterruptible power supply in a hospital. Another example involves the rupture of a vessel or piping that contains sufficient quantities of highly toxic or explosive substances such that a release would be hazardous to the safety of building occupants or the general public. In assessing whether failure of the mechanical or electrical equipment itself poses a hazard, certain judgments may be necessary. For example, small, flat-bottom tanks themselves may not need to be designed for earthquake loads, but the hazard of a large fluid spill associated with seismic failure of large, flat-bottom tanks suggests that the design of many, if not most, of such tanks should consider earthquake loads. Distinguishing between large and small, in this case, may require an assessment of potential damage caused by a spill of the fluid contents as outlined in Sec. 6.2.3 and Chapter 1 of ASCE-7

It is intended that the requirements provide guidance for the design of components for both conditions in the second category. This is primarily accomplished by increasing the design forces with an importance factor, I_p . However, this directly affects only structural integrity and stability. Function and operability of mechanical and electrical components may be affected only indirectly by increasing design forces. For complex components, testing or experience may be the only reasonable way to improve the assurance of function and operability. On the basis of past earthquake experience, it may

be reasonable to conclude that if structural integrity and stability are maintained, function and operability after an earthquake will be provided for many types of equipment components. On the other hand, mechanical joints in containment components (tanks, vessels, piping, etc.) may not remain leaktight in an earthquake even if leaktightness is re-established after the earthquake. Judgment may suggest a more conservative design related in some manner to the perceived hazard than would otherwise be provided by these requirements.

It is not intended that all equipment or parts of equipment be designed for seismic forces. Determination of whether these requirements need to be applied to the design of a specific piece of equipment or a part of that equipment will sometimes be a difficult task. When I_p is specified to be 1.0, damage to, or even failure of, a piece or part of a component is not a concern of these requirements so long as a hazard to life does not exist. Therefore, the restraint or containment of a falling, breaking, or toppling component (or its parts) by the use of bumpers, braces, guys, wedges, shims, tethers, or gapped restraints often may be an acceptable approach to satisfying these requirements even though the component itself may suffer damage. Judgment will be required if the intent of these requirements is to be fulfilled. The following example may be helpful: Since the threat to life is a key consideration, it should be clear that a nonessential air handler package unit that is less than 4 ft (1.2 m) tall bolted to a mechanical room floor is not a threat to life as long as it is prevented from significant motions by having adequate anchorage. Therefore, earthquake design of the air handler itself need not be performed. However, most engineers would agree that a 10-ft (3.0 m) tall tank on 6-ft (1.8 m) angles used as legs mounted on the roof near a building exit does pose a hazard. It is the intent of these requirements that the tank legs, the connections between the roof and the legs, the connections between the legs and the tank, and possibly even the tank itself be designed to resist earthquake forces. Alternatively, restraint of the tank by guys or bracing could be acceptable. Certain suspended components are exempt from lateral bracing requirements, provided they meet prescriptive force and interaction requirements.

It is not the intent of the *Provisions* to require the seismic design of shafts, buckets, cranks, pistons, plungers, impellers, rotors, stators, bearings, switches, gears, nonpressure retaining casings and castings, or similar items. Where the potential for a hazard to life exists, it is expected that design efforts will focus on equipment supports including base plates, anchorages, support lugs, legs, feet, saddles, skirts, hangers, braces, or ties.

Many mechanical and electrical components consist of complex assemblies of mechanical and/or electrical parts that typically are manufactured in an industrial process that produces similar or identical items. Such equipment may include manufacturer's catalog items and often are designed by empirical (trial-and-error) means for functional and transportation loadings. A characteristic of such equipment is that it may be inherently rugged. Rugged, as used herein, refers to an amplexness of construction that provides such equipment with the ability to survive strong motions without significant loss of function. By examining such equipment, an experienced design professional usually should be able to confirm such ruggedness. The results of an assessment of equipment ruggedness will be used in determining an appropriate method and extent of seismic design or qualification efforts.

It also is recognized that a number of professional and industrial organizations have developed nationally recognized codes and standards for the design and construction of specific mechanical and electrical components. In addition to providing design guidance for normal and upset operating conditions and various environmental conditions, some have developed earthquake design guidance in the context of the overall mechanical or electrical design. It is the intent of these requirements that such codes and standards having earthquake design guidance be used; normally the developers of such codes and standards are more familiar with the expected failure modes of the components for which they have developed design and construction rules. In particular, such codes and standards may be based on considerations that are not immediately obvious to the structural design professional. For example, in the design of industrial piping, seismic loads are not typically additive to thermal expansion loads. Given the potential for misunderstanding and mis-application of codes and standards specific to the design of mechanical and electrical systems, it is recommended that a registered design professional

familiar with these *Provisions*, as well as the those of the referenced code or standard used to evaluate the capacity of the mechanical or electrical components, should be involved in the review and acceptance of the seismic design process for such components. In addition, even if such codes and standards do not have earthquake design guidance, it is generally regarded that construction of mechanical and electrical equipment to nationally recognized codes and standards such as those approved by the American National Standards Institute provide adequate strength (with a safety margin often greater than that provided by structural codes) to accommodate all normal and upset operating loads. In this case, it could also be assumed that the component (especially if constructed of ductile materials) will not break up or break away from its supports in such a way as to pose a life-safety hazard. Earthquake damage surveys confirm this.

Specific guidance for selected components or conditions is provided in Sec. 6.4.5 through 6.4.9.

Testing is a well established alternative method of seismic qualification for small to medium size equipment. Several national standards have testing requirements adaptable for seismic qualification. AC 156, *Acceptance Criteria for Seismic Qualification Testing of Nonstructural Components*, is an acceptable shake table testing protocol, which meets the force requirements of the *Provisions* as well as ASCE 7-02.

6.4.1 Component period. Determination of the fundamental period of an item of mechanical or electrical equipment using analytical or in-situ testing methods can become very involved and can produce nonconservative results (that is, underestimated fundamental periods) if not properly performed.

When using analytical methods, it is absolutely essential to define in detail the flexibility of the elements of the equipment base, load path, and attachment to determine K_p . This base flexibility typically dominates equipment component flexibility and thus fundamental period.

When using test methods, it is necessary to ensure that the dominant mode of vibration of concern for seismic evaluation is excited and captured by the testing. This dominant mode of vibration typically cannot be discovered in equipment in-situ tests that measure only ambient vibrations. In order to excite the mode of vibration with the highest fundamental period by in-situ tests, relatively significant input levels of motion are required (that is, the flexibility of the base and attachment needs to be exercised). A procedure such as the resonant frequency search in AC 156 may be used to identify the dominant modes of vibration of the component.

Many types of mechanical components have fundamental periods below 0.06 sec and may be considered to be rigid. Examples include horizontal pumps, engine generators, motor generators, air compressors, and motor driven centrifugal blowers. Other types of mechanical equipment also are very stiff but may have fundamental periods up to approximately 0.125 sec. Examples of these mechanical equipment items include vertical immersion and deep well pumps, belt driven and vane axial fans, heaters, air handlers, chillers, boilers, heat exchangers, filters, and evaporators. These fundamental period estimates do not apply when the equipment is on vibration-isolator supports.

Electrical equipment cabinets can have fundamental periods of approximately 0.06 to 0.3 sec depending upon weight, stiffness of the enclosure assembly, flexibility of the enclosure base, and load path through to the attachment points. Tall, narrow motor control centers and switchboards lie in the upper end of this period range. Low- and medium-voltage switchgear, transformers, battery chargers, inverters, instrumentation cabinets, and instrumentation racks usually have fundamental periods ranging from 0.1 to 0.2 sec. Braced battery racks, stiffened vertical control panels, benchboards, electrical cabinets with top bracing, and wall-mounted panelboards have fundamental periods ranging from 0.06 to 0.1 sec.

6.4.2 and 6.4.3 Mechanical and electrical components. Past earthquakes have demonstrated that most mechanical and electrical equipment is inherently rugged and performs well provided that it is properly attached to the structure. This is because the operational and transportation loads for which the equipment is designed are typically larger than those due to earthquakes. For this reason, the

requirements focus primarily on equipment anchorage and attachments. However, it was felt that mechanical components required to maintain containment of flammable or hazardous materials should themselves be designed for seismic forces.

In addition, the reliability of equipment operability after an earthquake can be increased if the following items are also considered in design:

1. Internal assemblies, subassemblies, and electrical contacts are attached sufficiently to prevent their being subjected to differential movement or impact with other internal assemblies or the equipment enclosure.
2. Operators, motors, generators, and other such components that are functionally attached to mechanical equipment by means of an operating shaft or mechanism are structurally connected or commonly supported with sufficient rigidity such that binding of the operating shaft will be avoided.
3. Any ceramic or other nonductile components in the seismic load path are specifically evaluated.
4. Adjacent electrical cabinets are bolted together and cabinet lineups are prevented from banging into adjacent structural members.

Components that could be damaged or could damage other components and are fastened to multiple locations of a structure should be designed to accommodate seismic relative displacements. Examples of components that should be designed to accommodate seismic relative displacements include bus ducts, cable trays, conduit, elevator guide rails, and piping systems.

6.4.4 Supports and attachments. For some items such as piping, relative seismic displacements between support points generally are of more significance than inertial forces. Components made of ductile materials such as steel or copper can accommodate relative displacement effects by inelastically conforming to the support conditions. However, components made of less ductile materials can only accommodate relative displacement effects if appropriate flexibility or flexible connections are provided.

Of most concern are distribution systems that are a significant life-safety hazard and are routed between two separate building structures. Ductile components with bends and elbows at the building separation point or components that will be subject to bending stresses rather than direct tensile loads due to differential support motion are less prone to damage and are less likely to fracture and fall provided the supports can accommodate the imposed loads.

It is the intent of these requirements to ensure that all mechanical and electrical component supports be designed to accommodate the force and displacement effects prescribed. Component supports are differentiated here from component attachments to emphasize that the supports themselves, the structural members, braces, frames, skirts, legs, saddles, pedestals, cables, guys, stays, snubbers, and tethers, even if fabricated with and/or by the mechanical or electrical component manufacturer, should be designed for seismic forces. This is regardless of whether the mechanical or electrical component itself is designed for seismic loads. The intention is to prevent a component from sliding, falling, toppling, or otherwise moving such that the component would imperil life.

6.4.5 Utility and service lines. For essential facilities, auxiliary on-site mechanical and electrical utility sources are recommended. It is recommended that an appropriate clause be included if existing codes for the jurisdiction do not presently provide for it.

Sec. 6.4.5 requires that adequate flexibility be provided for utilities at the interface of adjacent and independent structures to accommodate anticipated differential displacement. It affects architectural and mechanical/electrical fittings only where water and energy lines pass through the interface. The displacements considered must include the C_d factor of Sec. 4.3.1 and should be in accordance with *Provisions* Sec. 6.2.7.

Consideration may be necessary for nonessential piping that carries quantities of materials that could damage essential utilities in the event of pipe rupture.

Following a review of information from the Northridge and Loma Prieta earthquakes and discussions with gas company personnel, automatic earthquake shutoff of gas lines at structure entry points is no longer required. The primary justification for this is the consensus opinion that shutoff devices tend to cause more problems than they solve. Commercially available shutoff devices are often susceptible to inadvertent shutoff caused by passing vehicles and other non-seismic vibrations. This leads to disruption of service and often requires that local gas companies reset such devices and relight any pilot lights. In an earthquake, the majority of shutoff devices which actuate will be attached to undamaged gas lines. This results in a huge relight effort for the local utility at a time when resources are typically at a premium. If the earthquake occurs during the winter, a greater life hazard may exist from a lack of gas supply than from potential gas leaks. In the future, as shutoff devices improve and gas-fired appliances which use pilots are phased out, it may be justified to require shutoff devices.

This is not meant to discourage individuals and companies from installing shutoff devices. In particular, individuals and companies who are capable of relighting gas-fired equipment should seriously consider installation of these devices. In addition, gas valves should be closed whenever leaks are detected.

6.4.6 HVAC ductwork. Experience in past earthquakes has shown that, in general, HVAC duct systems are rugged and perform well in strong shaking motions. Bracing in accordance with the Sheet Metal and Air Conditioning Contractors National Association SMACNA 80, SMACNA 95, and SMACNA 98 has been shown to be effective in limiting damage to duct systems under earthquake loads. Typical failures have affected system function only and major damage or collapse has been uncommon. Therefore, industry standard practices should prove adequate for most installations. Expected earthquake damage should be limited to opening of the duct joints and tears in the ducts. Connection details that are prone to brittle failures, especially hanger rods subject to large amplitude cycles of bending stress, should be avoided.

Some ductwork systems carry hazardous materials or must remain operational during and after an earthquake. Such ductwork system would be assigned a value of I_p greater than 1.0. A detailed engineering analysis for these systems should be performed.

All equipment attached to the ducts and weighing more than 75 lb (334 N), such as fans, humidifiers, and heat exchangers, should be braced independently of the duct. Unbraced in-line equipment can damage the duct by swinging and impacting it during an earthquake. Items attached to the duct (such as dampers, louvers, and air diffusers) should be positively supported by mechanical fasteners (not friction-type connections) to prevent their falling during an earthquake.

Where it is desirable to limit the deflection of duct systems under seismic load, bracing in accordance with the SMACNA references listed in Sec. 6.1.1 may be used.

6.4.7 Piping systems. Experience in past earthquakes has shown that, in general, piping systems are rugged and perform well in strong shaking motions. Numerous standards and guidelines have been developed covering a wide variety of piping systems and materials. Construction in accordance with current requirements of the referenced national standards have been shown to be effective in limiting damage to and avoiding loss of fluid containment in piping systems under earthquake conditions. It is therefore the intention of the *Provisions* that nationally recognized standards be used to design piping systems provided that the force and displacement demands are equal to or exceed those outlined in Sec. 6.2.6 and 6.2.7 and provision is made to mitigate seismic interaction issues not normally addressed in the national standards.

The following industry standards, while not adopted by ANSI, are in common use and may be appropriate reference documents for use in the seismic design of piping systems: SMACNA *Guidelines for the Seismic Restraint of Mechanical Systems* and ASHRAE CH 50-95 *Seismic Restraint Design Piping*.

6.4.8 Boilers and pressure vessels. Experience in past earthquakes has shown that, in general, boilers and pressure vessels are rugged and perform well in strong shaking motions. Construction in accordance with current requirements of the *ASME Boiler and Pressure Vessel Code* (ASME BPV) has been shown to be effective in limiting damage to and avoiding loss of fluid containment in boilers and pressure vessels under earthquake conditions. It is therefore the intention of the *Provisions* that nationally recognized codes be used to design boilers and pressure vessels provided that the seismic force and displacement demands are equal to or exceed those outlined in Sec. 6.2.6 and 6.2.7. Until such nationally recognized codes incorporate force and displacement requirements comparable to the requirements of Sec. 6.2.6 and 6.2.7, it is nonetheless the intention to use the design acceptance criteria and construction practices of those codes.

6.4.9 Elevators. The *ASME Safety Code for Elevators and Escalators* (ASME A17.1) has adopted many requirements to improve the seismic response of elevators; however, they do not apply to some regions covered by this chapter. These changes are to extend force requirements for elevators to be consistent with the *Provisions*.

6.4.9.2 Elevator machinery and controller supports and attachments. ASME A17.1 has no seismic requirements for supports and attachments for some structures and zones where the *Provisions* are applicable. Criteria are provided to extend force requirements for elevators to be consistent with the intent and scope of the *Provisions*.

6.4.9.3 Seismic switches. The purpose of seismic switches as used here is different from that of ASME A17.1, which has incorporated several requirements to improve the seismic response of elevators (such as rope snag point guard, rope retainer guards, and guide rail brackets) and which does not apply to some buildings and zones covered by the *Provisions*. Building motions that are expected in these uncovered seismic zones are sufficiently large to impair the operation of elevators. The seismic switch is positioned high in the structure where structural response will be the most severe. The seismic switch trigger level is set to shut down the elevator when structural motions are expected to impair elevator operations.

Elevators in which the seismic switch and counterweight derail device have triggered should not be put back into service without a complete inspection. However, in the case where the loss of use of the elevator creates a life-safety hazard, an attempt to put the elevator back into service may be attempted. Operating the elevator prior to inspection may cause severe damage to the elevator or its components.

The building owner should have detailed written procedures in place defining for the elevator operator/maintenance personnel which elevators in the facility are necessary from a post-earthquake life safety perspective. It is highly recommended that these procedures be in-place, with appropriate personnel training, prior to an event strong enough to trip the seismic switch.

Once the elevator seismic switch is reset, it will respond to any call at any floor. It is important that the detailed procedure include the posting of “out-of-service for testing” signs at each door at each floor, prior to resetting the switch. Once the testing is completed and the elevator operator/maintenance personnel are satisfied that the elevator is safe to operate, the signs can be removed.

6.4.9.4 Retainer plates. The use of retainer plates is a very low cost provision to improve the seismic response of elevators.

RELATED CONCERNS

Maintenance. Mechanical and electrical devices installed to satisfy the requirements of the *Provisions* (for example, resilient mounting components or certain protecting devices) require maintenance to ensure their reliability and to provide protection in case of a seismic event for which they are designed. Specifically, rubber-in-shear mounts or spring mounts (if exposed to weathering) may deteriorate with time and, thus, periodic testing is required to ensure that their damping action will be available during an earthquake. Pneumatic mounting devices and electric switchgear must be maintained free of dirt and corrosion. How a regulatory agency could administer such periodic inspections has not been determined, so requirements to cover these situations have not been included.

Tenant improvements. It is intended that the requirements in Chapter 6 also apply to newly constructed tenant improvements that are listed in Tables 6.3-1 and 6.4-1 and that are installed at any time during the life of the structure.

Minimum standards. Criteria represented in the *Provisions* represent minimum standards. They are designed to minimize hazard for occupants and to improve the likelihood of functioning of facilities required by the community to deal with the consequences of a disaster. They are not designed to protect the owner's investment, and the designer of the facility should review with the owner the possibility of exceeding these minimum standards so as to limit his economic risk.

The risk is particularly acute in the case of sealed, air-conditioned structures where downtime after a disaster can be materially affected by the availability of parts and labor. The parts availability may be significantly worse than normal because of a sudden increase in demand. Skilled labor also may be in short demand since available labor forces may be diverted to high priority structures requiring repairs.

Architect-Engineer design integration. The subject of architect-engineer design integration is raised here because it is believed that all members of the profession should clearly understand that Chapter 6 is a compromise based on concerns for enforcement and the need to develop a simple, straightforward approach. It is imperative that, from the outset, architectural input concerning definition of occupancy classification and the required level of seismic resistance be properly considered in the structural engineer's approach to seismic safety if the design profession as a whole is to make any meaningful impact on the public awareness of this matter. It is hoped that, as the design profession gains more knowledge and sophistication in the use of seismic design, a more comprehensive approach to earthquake design requirements will be developed.

REFERENCES

ANCO Engineers, Inc. 1983. *Seismic Hazard Assessment of Non-Structural Components—Phase I*, Final Report for National Science Foundation from ANCO Engineers, Inc., Culver City, California, September.

Bachman, R. E., and R. M. Drake. 1996. "A Study To Empirically Validate the Component Response Modification Factors in the 1994 *NEHRP Provisions* Design Force Equations for Architectural, Mechanical, and Electrical Components," letter report to the National Center for Earthquake Engineering Research, July.

Bachman, R. E., R. M. Drake, and P. J. Richter. 1993. *1994 Update to 1991 NEHRP Provisions for Architectural, Mechanical, and Electrical Components and Systems*, letter report to the National Center for Earthquake Engineering Research, February 22.

Behr, R.A., Belarbi, A. and Brown, A.T., 1995, "Seismic Performance of Architectural Glass in a Storefront Wall System," *Earthquake Spectra*, Vol. 11, No. 3, pp. 367-391.

Behr, R.A. and Belarbi, A., 1996, "Seismic Tests Methods for Architectural Glazing Systems," *Earthquake Spectra*, Vol. 12, No. 1, pp. 129-143.

Bouwkamp, J. G. and Meehan, J. F. 1960. "Drift Limitations Imposed by Glass," Proceedings of the Second World Conference on Earthquake Engineering. Tokyo, Japan. pp. 1763-1778.

Drake, R. M., and R. E. Bachman. 1996. "NEHRP Provisions for 1994 for Nonstructural Components," *ASCE Journal of Architectural Engineering*, March.

Drake, R. M., and R. E. Bachman. 1995. "Interpretation of Instrumented Building Seismic Data and Implications for Building Codes," in *Proceedings of the 1995 SEAOC Annual Convention*.

Drake, R. M., and R. E. Bachman. 1994. "1994 NEHRP Provisions for Architectural, Mechanical, and Electrical Components," in *Proceedings*, 5th United States National Conference on Earthquake Engineering.

Earthquake Engineering Research Institute (EERI), 1994, "Northridge Earthquake January 17, 1994: Preliminary Reconnaissance Report," ed. John F. Hall, Oakland, California, pp. 56-57.

Gates, W.E. and McGavin, G., 1998, "Lessons Learned from the 1994 Northridge Earthquake on the Vulnerability of Nonstructural Systems," Proceedings, Seminar on Seismic Design, Retrofit, and Performance of Nonstructural Components, ATC-29-1, January 22-23, 1998, San Francisco, California, Applied Technology Council, Redwood City, California, pp. 93-101.

Housner, G. W., and M. A. Haroun. 1980. "Seismic Design of Liquid Storage Tanks" in *ASCE Convention Proceedings*.

Pantelides, C.P., Truman, K.Z., Behr, R.A. and Belarbi, A., 1996, "Development of a Loading History for Seismic Testing of Architectural Glass in a Shop-Front Wall System," *Engineering Structures*, Vol. 18, No. 12, pp. 917-935.

Wright, P. D. 1989. "The Development of a Procedure and Rig for Testing the Racking Resistance of Curtain Wall Glazing"; Building Research Association of New Zealand (BRANZ) Study Report No. 17; p. 18.

Acknowledgment

The National Science Foundation (Grant No. CMS 9213172) provided major funding for the experimental results summarized in Sec. C6.3.7.

End note: The American Architectural Manufacturers Association (AAMA) has issued AAMA 501.4-2000: "Recommended Static Test Method for Evaluating Curtain Wall and Storefront Systems Subjected to Seismic and Wind Induced Interstory Drifts." In contrast with the dynamic displacements employed in the crescendo tests described in this section, static displacements are employed in AAMA's recommended test method. Correlations between the results of the static and dynamic test methods have not yet been established with regard to the seismic performance of architectural glazing systems.

Note that this section addresses glass in frames subject to interstory drift. Glass frames not subject to interstory drift, such as freestanding guards and screens, are not covered by this section.

This page is intentionally left blank.

Appendix to Chapter 6 Commentary

ALTERNATIVE PROVISIONS FOR THE DESIGN OF PIPING SYSTEMS

A6.1 Seismic Interaction. There are two types of seismic interactions: system interactions and spatial interactions. A system interaction is a spurious or erroneous signal resulting in unanticipated operating conditions, such as the spurious start-up of a pump motor or the unintended closure of a valve. Spatial interactions are interactions caused by the failure of a structure or component in close proximity. Spatial interactions can in turn be further divided into falling interactions, swing interactions, and spray interactions. A falling interaction is an impact on a critical component due to the fall of overhead or adjacent equipment or structure. A swing interaction is an impact due to the swing or rocking of adjacent component or suspended system. A spray interaction is due to the leakage of overhead or adjacent piping or vessels.

Any interaction involves two components, a source and a target. An interaction source is the component or structure that could fail and interact with the seismically designed component. An interaction target is a seismically qualified component that is being impacted, sprayed or spuriously activated. For an interaction to affect a seismically qualified component, it must be credible and significant. A credible interaction is one that can take place. For example, the fall of a ceiling panel located overhead from a motor control center is a credible interaction because the falling panel can reach and impact the motor control center. The target (the MCC) is said to be within the zone of influence of the source (the ceiling panel). A significant interaction is one that can result in damage to the target. For example, the fall of a light fixture on a 20" steel pipe may be credible (the light fixture being above the pipe) but may not be significant (the light fixture will not damage the steel pipe). In contrast, the overturning of a rack on an instrument panel is a significant interaction.

The process of considering seismic interactions begins with a interaction review. For new structures, this involves examination of the design drawings, to identify the interaction targets, and credible and significant sources of interaction. In many cases, the design documents may only locate components and systems in schematic terms. The actual location of, for example, piping and ductwork systems is determined in the field. In this case, and where work is being performed on an existing structure, it is necessary to begin the interaction review with a walk-down, typically with a photographic record. Based on the assembled data, supporting calculations to document credible and significant sources of interactions can be prepared.

In practice, it is only necessary to document credible and significant sources of interaction. It is not necessary to list and evaluate every single overhead or adjacent component in the area around the target, only those that could interact and whose interaction could damage the target. Because only credible and significant sources of interaction are documented, an important aspect of the interaction review is engineering judgment. The spatial interaction review should therefore be performed by experienced seismic design engineers.

Where system interactions are of importance the written input of a system engineer is in order.

This page is intentionally left blank.

Chapter 7 Commentary

FOUNDATION DESIGN REQUIREMENTS

7.1 GENERAL

7.1.1 Scope. The minimum foundation design requirements that might be suitable when any consideration must be given to earthquake resistance are set forth in Chapter 7. It is difficult to separate foundation requirements for minimal earthquake resistance from the requirements for resisting normal vertical loads. In order to have a minimum base from which to start, this chapter assumes compliance with all basic requirements necessary to provide support for vertical loads and lateral loads other than earthquake. These basic requirements include, but are not limited to, provisions for the extent of investigation needed to establish criteria for fills, slope stability, expansive soils, allowable soil pressures, footings for specialized construction, drainage, settlement control, and pile requirements and capacities. Certain detailing requirements and the allowable stresses to be used are provided in other chapters of the *Provisions* as are the additional requirements to be used in more seismically active locations.

7.2 GENERAL DESIGN REQUIREMENTS

7.2.2 Soil capacities. This section requires that the building foundation without seismic forces applied must be adequate to support the building gravity load. When seismic effects are considered, the soil capacities can be increased considering the short time of loading and the dynamic properties of the soil. It is noted that the Appendix to Chapter 7 introduces into the *Provisions* ultimate strength design (USD) procedures for the geotechnical design of foundations. The *Commentary* Appendix to Chapter 7 provides additional guidance and discussion of the USD procedures.

7.2.3 Foundation load-deformation characteristics. The Appendix to Chapter 7 (*Provisions* and *Commentary* (Sec. A7.2.3) provides guidance on modeling load-deformation characteristics of the foundation-soil system (foundation stiffness). The guidance contained therein covers both linear and nonlinear analysis methods.

7.3 SEISMIC DESIGN CATEGORY B

There are no special seismic provisions for the design of foundations for buildings assigned to Seismic Design Category B.

7.4 SEISMIC DESIGN CATEGORY C

Extra precautions are required for the seismic design of foundations for buildings assigned to Seismic Design Category C.

7.4.1 Investigation. This section reviews procedures that are commonly used for evaluating potential site geologic hazards due to earthquakes, including slope instability, liquefaction, and surface fault rupture. Geologic hazards evaluations should be carried out by qualified geotechnical professionals and documented in a written report.

Screening Evaluation. Evaluation of geologic hazard may initially consist of a screening evaluation. If the screening evaluation clearly demonstrates that a hazard is not present, then more detailed evaluations, using procedures such as those described in the following sections, need not be conducted. Reference to the following publications are suggested for guidelines on screening evaluations: California Division of Mines and Geology (1997) – slope instability; Blake et al. (2002) and Stewart et al. (2003) – slope instability; Martin and Lew (1999) – liquefaction; U.S. Army Corps of Engineers (1998) – slope instability; liquefaction; surface fault rupture. More detailed evaluation procedures such as those described below should be used if a hazard cannot be screened out.

Slope instability hazard. The stability of slopes composed of dense (nonliquefiable) or nonsaturated sandy soils or nonsensitive clayey soils can be determined using standard procedures.

For initial evaluation, the pseudostatic analysis may be used. (The deformational analysis described below, however, is now preferred.) In the pseudostatic analysis, inertial forces generated by earthquake shaking are represented by an equivalent static horizontal force acting on the slope. The seismic coefficient for this analysis should be the peak ground acceleration, a_{max} or $S_{DS}/2.5$. The factor of safety for a given seismic coefficient can be estimated by using traditional slope stability calculation methods. A factor of safety greater than one indicates that the slope is stable for the given lateral force level and further analysis is not required. A factor of safety of less than one indicates that the slope will yield and slope deformation can be expected and a deformational analysis should be made using the techniques discussed below.

Deformational analyses resulting in estimates of slope displacement are now accepted practice. The most common analysis, termed a Newmark analysis (Newmark, 1965), uses the concept of a frictional block sliding on a sloping plane or arc. In this analysis, seismic inertial forces are calculated using a time history of horizontal acceleration as the input motion. Slope movement occurs when the driving forces (gravitational plus inertial) exceed the resisting forces. This approach estimates the cumulative displacement of the sliding mass by integrating increments of movement that occur during periods of time when the driving forces exceed the resisting forces. Displacement or yield occurs when the earthquake ground accelerations exceed the acceleration required to initiate slope movement or yield acceleration. The yield acceleration depends primarily on the strength of the soil and the gradient and height and other geometric attributes of the slope. See Figure C7.4-1 for forces and equations used in analysis and Figure C7.4-2 for a schematic illustration for a calculation of the displacement of a soil block toward a bluff.

Acceptable methods for the determination of displacements on many projects involve the use of charts that show displacements for different acceleration ratios, where the acceleration ratio is defined as the ratio of yield acceleration to peak ground acceleration. Various charts have been developed, including those by Franklin and Chang (1977), Makdisi and Seed (1978), Wong and Whitman (1982), Hynes and Franklin (1984), Martin and Qiu (1994); and Bray and Rathje (1998). The selection between the different charts should be made on the basis of the type of slope and the degree of conservatism necessary for the project. A number of the chart methods were developed for the estimation of displacements for dams, and therefore, may be more suitable for embankment designs. Recommendations on the use of such procedures for typical building construction are presented by Blake et al. (2002).

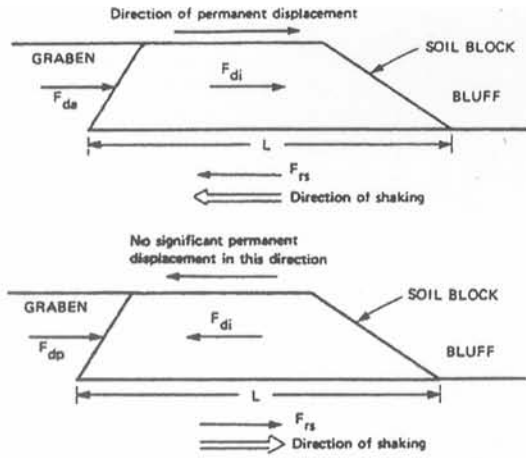

- F_{da} = driving force due to active soil pressure
- F_{di} = driving force due to earthquake inertia
- F_{rs} = resisting force due to soil shear strength
- F_{dp} = resisting force due to passive soil pressure
- $F_{di} = K_{max} W$

where K_{max} = maximum seismic coefficient and W = weight of soil block

$$F_{rs} = S_u L$$

where S_u = average undrained shear strength of soil and L = length of soil block

Yield seismic coefficient:

$$K_y = \frac{F_{rs} - F_{da}}{W}$$

Figure C7.4-1 Forces and equations used in analysis of translatory landslides for calculating permanent lateral displacements from earthquake ground motions (National Research Council, 1985; from Idriss, 1985)

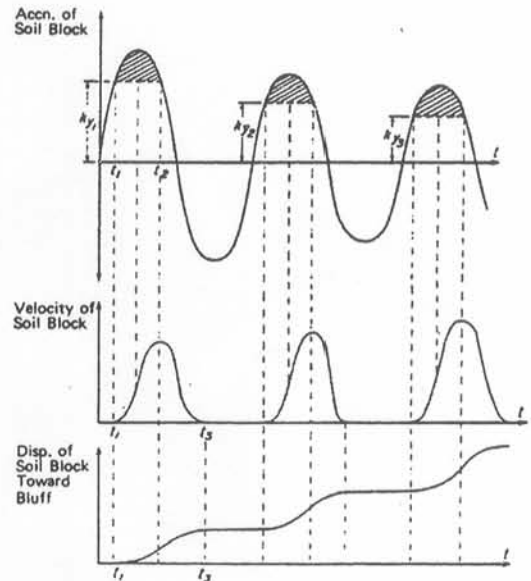
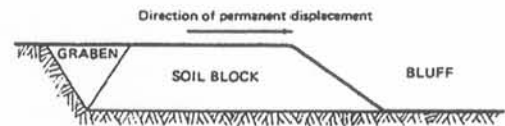

Figure C7.4-2 Schematic illustration for calculating displacement of soil block toward the bluff (National Research Council, 1985; from Idriss, 1985, adapted from Goodman and Seed, 1966)

Mitigation of slope instability hazard. With respect to slope instability, three general mitigative measures might be considered: design the structure to resist the hazard, stabilize the site to reduce the hazard, or choose an alternative site. Ground displacements generated by slope instability are similar in destructive character to fault displacements generating similar senses of movement: compression, shear, extension or vertical. Thus, the general comments on structural design to prevent damage given under mitigation of fault displacement apply equally to slope displacement. Techniques to stabilize a site include reducing the driving forces by grading and drainage of slopes and increasing the resisting forces by subsurface drainage, buttresses, ground anchors, reaction piles or shafts, ground improvement using densification or soil mixing methods, or chemical treatment.

Liquefaction hazard. Liquefaction of saturated granular soils has been a major source of building damage during past earthquakes. Loss of bearing strength, differential settlement, and horizontal displacement due to lateral spreads have been the direct causes of damage. Examples of this damage can be found in reports from many of the more recent earthquakes in the United States, including the 1964 Alaska, the 1971 San Fernando, the 1989 Loma Prieta, the 1994 Northridge, the 2001 Nisqually, and the 2003 Denali earthquakes. Similar damage was reported after the 1964 Niigata, the 1994 Hyogoken-Nanbu (Kobe), the 1999 Taiwan, and the 1999 Turkey earthquakes. As earthquakes occur in the future, additional cases of liquefaction-related damage must be expected. Design to prevent damage due to liquefaction consists of three parts: evaluation of liquefaction hazard, evaluation of potential ground displacement, and mitigating the hazard by designing to resist ground displacement or strength loss, by reducing the potential for liquefaction, or by choosing an alternative site with less hazard.

Evaluation of liquefaction hazard. Liquefaction hazard at a site is commonly expressed in terms of a factor of safety. This factor is defined as the ratio between the available liquefaction resistance, expressed in terms of the cyclic stresses required to cause liquefaction, and the cyclic stresses generated by the design earthquake. Both of these stress parameters are commonly normalized with respect to the effective overburden stress at the depth in question to define a cyclic resistance ratio (CRR) and a cyclic stress ratio induced by the earthquake (CSR).

The following possible methods for calculating the factor of safety against liquefaction have been proposed and used to various extents:

1. **Empirical Methods**—The most widely used method in practice involves empirical procedures. These procedures rely on correlations between observed cases of liquefaction and measurements made in the field with conventional exploration methods. Seed and Idriss (1971) first published the widely used “simplified procedure” utilizing the Standard Penetration Test (SPT). Since then, the procedure has evolved, primarily through summary papers by Professor H.B. Seed and his colleagues, and field test methods in addition to the SPT have been utilized in similar simplified procedures. These methods include cone penetrometer tests (CPTs), Becker hammer tests (BHTs), and shear wave velocity tests (SVTs). In 1996, a workshop sponsored by the National Center for Earthquake Engineering Research (NCEER) was convened by Professors T.L. Youd and I.M. Idriss with 20 experts to review and update the simplified procedure which had last been updated in 1985. The update of the simplified procedure that resulted from the NCEER workshop (termed herein the “Liquefaction Workshop”) is summarized in NCEER (1997) and in Youd et al. (2001). Martin and Lew (1999) focused on the implementation of this procedure in engineering practice, especially for southern California. The procedure described in NCEER (1997), Youd et al. (2001), and Martin and Lew (1999) using the Standard Penetration Test (SPT) is later summarized in this section.
2. **Analytical Methods**—Analytical methods are used less frequently to evaluate liquefaction potential – though they may be required for special projects or where soil conditions are not amenable to the empirical method. Analytical methods will also likely gain prominence with time as numerical methods and soil models improve and are increasingly validated. Originally (circa 1970s) the analytical method involved determination of the induced shearing stresses with a program such as SHAKE and comparing these stresses to results of cyclic triaxial or cyclic simple shear tests. Now the analytical method usually refers to a computer code that incorporates a soil model that calculates the buildup in pore water pressure. These more rigorous numerical methods include one-dimensional, nonlinear effective stress codes such as DESRA and SUMDES and two dimensional, nonlinear effective stress codes such as FLAC, TARA, and DYNAFLOW. This new generation of analytical methods has soil models that are fit to laboratory data or liquefaction curves derived from SPT information. The methods are limited by the ability to represent the soil model from either the laboratory or field measurements and by the complexity of the wave propagation mechanisms, including the ability to select appropriate earthquake records to use in the analyses.
3. **Physical Modeling**—These methods typically involved the use of centrifuges or relatively small-scale shaking tables to simulate seismic loading under well defined boundary conditions. More recently these methods have been expanded to include large laminar boxes mounted on very large

shake tables and full-scale field blast loading tests. Physical modeling of liquefaction is one of the main focus areas of the 2004-2014 Network for Earthquake Engineering Simulation (NEES) supported by the National Science Foundation. Soil used in the small-scale and laminar box models is reconstituted to represent different density and geometrical conditions. Because of difficulties in precisely modeling in-situ conditions at liquefiable sites, small-scale and laminar box models have seldom been used in design studies for specific sites. However, physical models are valuable for analyzing and understanding generalized soil behavior and for evaluating the validity of constitutive models under well defined boundary conditions. Recently, blast loading tests have been conducted to capture the in situ characteristics of the soil for research purposes (e.g., Treasure Island, California and in Japan). However, the cost and safety issues of this approach limits its use to only special design or research projects.

The empirical approach for evaluating liquefaction hazards based on the Liquefaction Workshop and described in NCEER (1997) and Youd et al. (2001) is summarized in the following paragraphs.

The first step in the liquefaction hazard evaluation using the empirical approach is usually to define the normalized cyclic shear stress ratio (CSR) from the peak horizontal ground acceleration expected at the site. This evaluation is made using the following simple equation:

$$CSR = 0.65 \left(a_{max}/g \right) \left(\sigma_o / \sigma'_o \right) r_d \quad (C7.4-1)$$

where (a_{max}/g) = peak horizontal acceleration at ground surface expressed as a decimal fraction of gravity, σ_o = the vertical total stress in the soil at the depth in question, σ'_o = the vertical effective stress at the same depth, and r_d = deformation-related stress reduction factor.

The peak ground acceleration, a_{max} , commonly used in liquefaction analysis is that which would occur at the site in the absence of liquefaction. Thus, the a_{max} used in Eq. C7.4-1 is the estimated rock acceleration corrected for soil site response but with neglect of excess pore-water pressures that might develop. The acceleration can be determined using the general procedure described in Sec. 3.3 and taking a_{max} equal to $S_{DS}/2.5$. Alternatively, a_{max} can be estimated from: (1) values obtained from the USGS national ground motion maps [see internet website <http://geohazards.cr.usgs.gov/eq/>] for a selected probability of exceedance, with correction for site effects using the F_a site factor in Sec. 3.3; or (2) from a site-specific ground motion analysis conforming to the requirements of Sec. 3.4.

The stress reduction factor, r_d , used in Eq. C7.4-1 was originally determined using a plot developed by Seed and Idriss (1971) showing the reduction factor versus depth. The consensus from the Liquefaction Workshop was to represent r_d by the following equations:

$$r_d = 1.0 - 0.00765z \text{ for } z \leq 9.15 \text{ m} \quad (C7.4-2)$$

$$r_d = 1.174 - 0.267z \text{ for } 9.15 \text{ m} < z \leq 23 \text{ m}$$

It should be noted that because nearly all the field data used to develop the simplified procedure are for depths less than 12 m, there is greater uncertainty in the evaluations at greater depths. The second step in the liquefaction hazard evaluation using the empirical approach usually involves determination of the normalized cyclic resistance ratio (CRR). The most commonly used empirical relationship for determining CRR was originally compiled by Seed et al. (1985). This relationship compares CRR with corrected Standard Penetration Test (SPT) resistance, $(N_1)_{60}$, from sites where liquefaction did or did not develop during past earthquakes. Figure C7.4-3 shows this relationship for Magnitude 7.5 earthquakes, with an adjustment at low values of CRR recommended by the Liquefaction Workshop. Similar relationships have been developed for determining CRR from CPT soundings, from BHT blowcounts, and from shear wave velocity data, as discussed by Youd et al. (2001) and as presented in detail in NCEER (1997). Only the SPT method is presented herein because of its more common use.

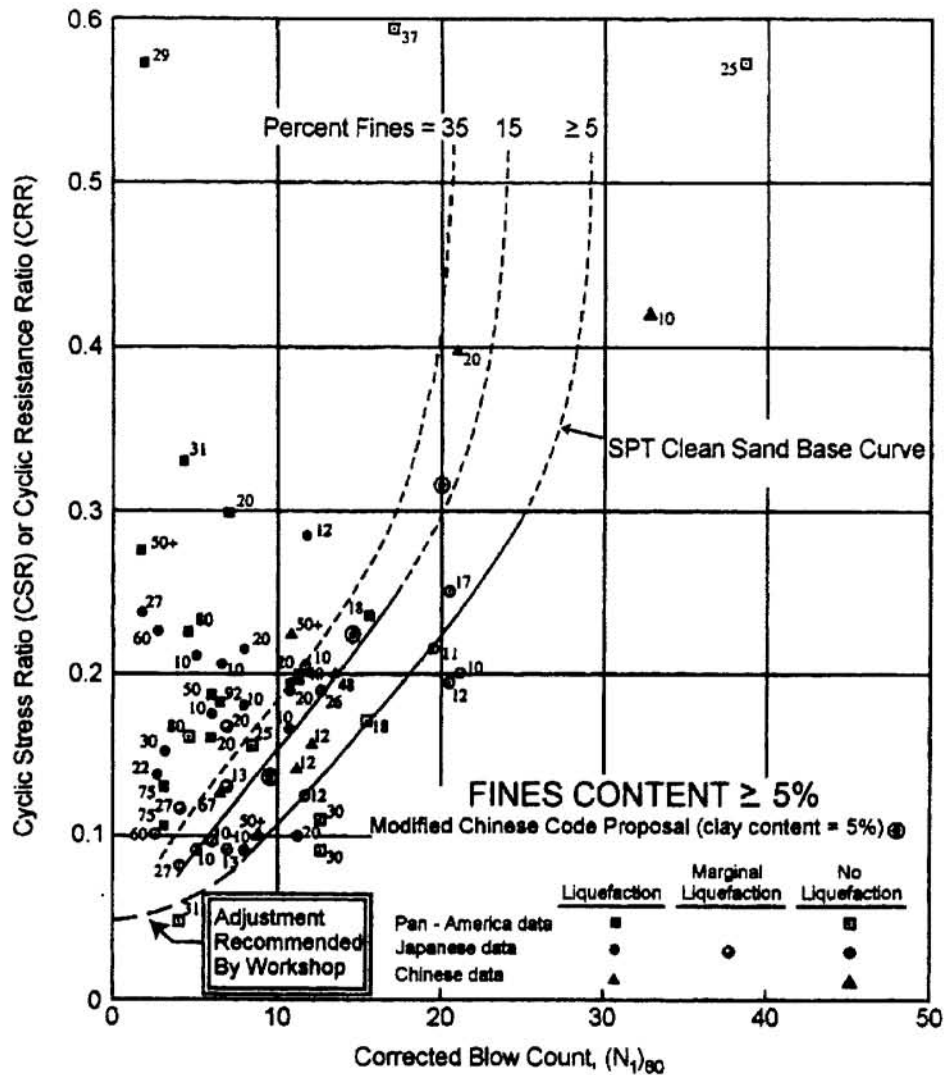

Figure C7.4-3. SPT clean sand base curve for magnitude 7.5 earthquakes with data from liquefaction case histories. (Modified from Seed et al., 1985). (NCEER, 1997; Youd et al., 2001).

In Figure C7.4-3, CRRs calculated for various sites are plotted against $(N_1)_{60}$, where $(N_1)_{60}$ is the SPT blowcount normalized for an overburden stress of 100 kPa and for an energy ratio of 60 percent. Solid symbols represent sites where liquefaction occurred and open symbols represent sites where surface evidence of liquefaction was not found. Curves were drawn through the data to separate regions where liquefaction did and did not develop. As shown, curves are given for soils with fines contents (FC) ranging from less than 5 to 35 percent.

While Figure C7.4-3 provides information about the variation in CRR with fines content, the preferred approach from the Liquefaction Workshop for adjusting for fines is to correct $(N_1)_{60}$ to an equivalent clean sand value, $(N_1)_{60cs}$ using the following equations:

$$(N_1)_{60cs} = \alpha + \beta(N_1)_{60} \tag{C7.4-3}$$

where α and β = coefficients determined from the following relationships:

- $\alpha = 0$ for $FC \leq 5\%$
- $\alpha = \exp[1.76 - (190/FC^2)]$ for $5\% < FC < 35\%$
- $\alpha = 5.0$ for $FC \geq 35\%$

$$\beta = 1.0 \text{ for FC} \leq 5\%$$

$$\beta = [0.99 + (\text{FC}^{1.5}/1,000)] \text{ for } 5\% < \text{FC} < 35\%$$

$$\beta = 1.2 \text{ for FC} \geq 35\%$$

Several other corrections are made to $(N_I)_{60}$, as represented in the following equation:

$$(N_I)_{60} = N_m C_N C_E C_B C_R C_S \quad (\text{C7.4-4})$$

where N_m = measured standard penetration resistance; C_N = factor to normalize N_m to a common reference effective overburden stress; C_E = correction for hammer energy ratio (ER); C_B = correction factor for borehole diameter; C_R = correction factor for rod length; and C_S = correction for samples with or without liners. Values given in Youd, et al., 2001) are shown in Table C.4-1. An alternative equation for C_n from that shown in the table (Youd, et al., 2001):

$$C_N = 2.2 / [1.2 + \sigma'_{vo}/Pa] \quad (\text{C7.4-5})$$

where the maximum value of C_N is equal to 1.7. The effective vertical stress, σ'_{vo} , is the stress at the time of the SPT measurement. Youd et al. (2001) caution that other means should be used to evaluate C_N if σ'_{vo} is greater than 300 kPa.

Factor	Equipment variable	Term	Correction
Overburden pressure	---	C_N	$(P_d/\sigma'_{vo})^{0.5}$
Overburden pressure	---	C_N	$C_N < 1.7$
Energy ratio	Donut hammer	C_E	0.5 – 1.0
Energy ratio	Safety hammer	C_E	0.7 – 1.2
Energy ratio	Automatic-trip Donut-type hammer	C_E	0.8 – 1.3
Borehole diameter	65 – 115 mm	C_B	1.0
Borehole diameter	150 mm	C_B	1.05
Borehole diameter	200 mm	C_B	1.15
Rod length	< 3	C_R	0.75
Rod length	3 – 4 m	C_R	0.8
Rod length	4 -6 m	C_R	0.85
Rod length	6 – 10 m	C_R	0.95
Rod length	10 – 30 m	C_R	1.0
Sampling method	Standard sampler	C_S	1.0
Sampling method	Sampler without liners	C_S	1.1 – 1.3

It is very important that the engineer consider these correction factors when conducting the liquefaction analyses. Failure to consider these corrections can result in inaccurate liquefaction estimates – leading

to either excessive cost to mitigate the liquefaction concern or excessive risk of poor performance during a design event – potentially resulting in unacceptable damage.

Special mention also needs to be made of the energy calibration term, C_E . This correction has a very significant effect on the $(N_1)_{60}$ used to compute CRR. The value of this correction factor can vary greatly depending on the SPT hammer system used in the field and on site conditions. For important sites where C_E could result in changes from liquefied to non liquefied, energy ratio measurements should be made. These measurements are relatively inexpensive and represent a small increase in overall field exploration costs. Many drilling contractors in areas that are seismically active provide calibrated equipment as part of their routine service.

Before computing the factor of safety from liquefaction, the CRR result obtained from Figure C7.4-3 (using the corrected SPT blow count identified in the equation for $(N_1)_{60}$) must be corrected for earthquake magnitude M if the magnitude differs from 7.5. The magnitude correction factor is shown in Figure C7.4-4. This plot was developed during the Liquefaction Workshop on the basis of input from experts attending the workshop. The range shown in Figure C7.4-4 is used because of uncertainties. The user should select a value consistent with the project risk. For M greater than 7.5 the factors recommended by Idriss (second from highest) should be used.

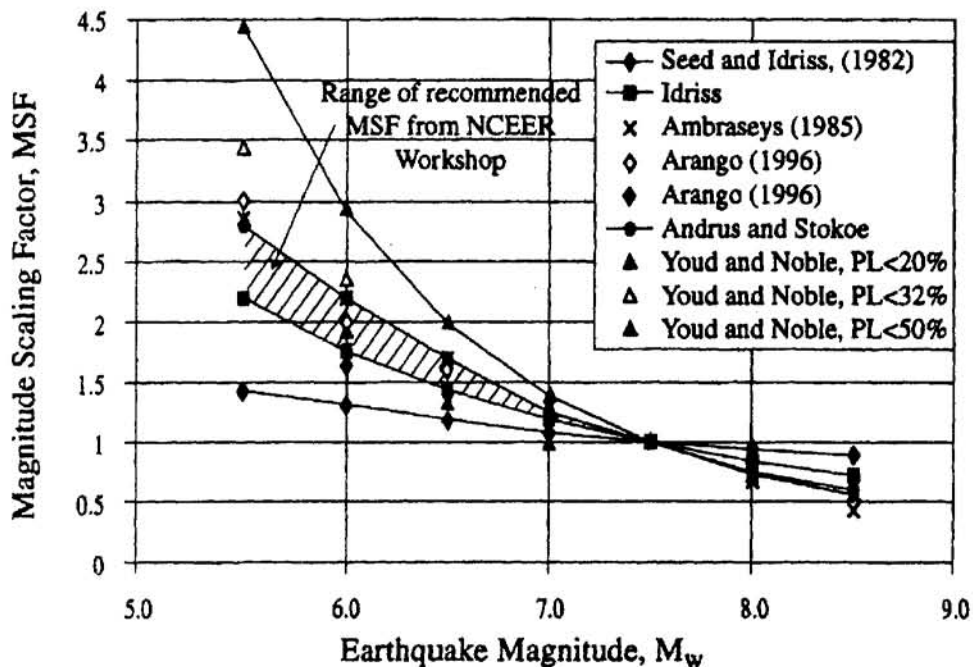

Figure C7.4-4. Magnitude scaling factors derived by various investigators. (NCEER, 1997; Youd et al., 2001)

The magnitude, M , needed to determine a magnitude scaling factor from Figure C7.4-4 should correspond to the Maximum Considered Earthquake (MCE). Where the general procedure for ground motion estimation is used (Sec. 3.3) and the MCE is determined probabilistically, the magnitude used in these evaluations can be obtained from deaggregation information available by latitude and longitude from the USGS website (<http://geohazards.cr.usgs.gov/eq/>). Where the general procedure (Sec. 3.3) is used and the MCE is bounded deterministically near known active fault sources (*Commentary Appendix A*), the magnitude of the MCE should be the characteristic maximum magnitude assigned to the fault in the construction of the MCE ground motion maps. Where the site-specific procedure for ground motion estimation is used (Sec. 3.4), the magnitude of the MCE should be similarly determined from the site-specific analysis. In all cases, it should be remembered that the likelihood of liquefaction at the site (as defined later by the factor of safety F_L in Eq. C7.4-6) is determined jointly by a_{max} and M and not by a_{max} alone. Because of the longer duration of strong ground-shaking, large distant earthquakes may in

some cases generate liquefaction at a site while smaller nearby earthquakes may not generate liquefaction even though a_{max} of the nearer events is larger than that from the more distant events.

The final step in the liquefaction hazard evaluation using the empirical approach involves the computation of the factor of safety (F_L) against liquefaction using the equation:

$$F_L = CRR/CSR \tag{C7.4-6}$$

If F_L is greater than one, then liquefaction should not develop. If at any depth in the sediment profile, F_L is equal to or less than one, then there is a liquefaction hazard. Although the curves shown in Figure C7.4-3 envelop the plotted data, it is possible that liquefaction may have occurred beyond the enveloped data and was not detected at ground surface. For this reason a factor of safety of 1.2 to 1.5 is usually appropriate for building sites – with the actual factor selected on the basis of the importance of the structure and the potential for ground displacement at the site.

Additional guidance on the selection of the appropriate factor of safety is provided by Martin and Lew 1999. They suggest that the following factors be considered when selecting the factor of safety:

1. The type of structure and its vulnerability to damage.
2. Levels of risk accepted by the owner or governmental regulations with questions related to design for life safety, limited structural damage, or essentially no damage.
3. Damage potential associated with the particular liquefaction hazards. Flow failures or major lateral spreads pose more damage potential than differential settlement. Hence factors of safety could be adjusted accordingly.
4. Damage potential associated with design earthquake magnitude. A magnitude 7.5 event is potentially more damaging than a 6.5 event.
5. Damage potential associated with SPT values; low blow counts have a greater cyclic strain potential than higher blowcounts.
6. Uncertainty in SPT- or CPT- derived liquefaction strengths used for evaluations. Note that a change in silt content from 5 to 15 percent could change a factor of safety from, say, 1.0 to 1.25.
7. For high levels of design ground motion, factors of safety may be indeterminate. For example, if $(N_1)_{60} = 20$, $M = 7.5$, and fines content = 35 percent, liquefaction strengths cannot be accurately defined due to the vertical asymptote on the empirical strength curve.

Martin and Lew (1999) indicate that the final choice of an appropriate factor of safety must reflect the particular conditions associated with the specific site and the vulnerability of site-related structures. Table C7.4-2 summarizes factors of safety suggested by Martin and Lew.

Table C7.4-2. Factors of safety for liquefaction hazard assessment (from Martin and Lew, 1999).

Consequences of Liquefaction	$(N_1)_{60cs}$	Factor of Safety
Settlement	≤ 15	1.1
	≥ 30	1.0
Surface Manifestations	≤ 15	1.2
	≥ 30	1.0
Lateral Spread	≤ 15	1.3
	≥ 30	1.0

As a final comment on the assessment of liquefaction hazards, it is important to note that soils composed of sands, silts, and gravels are most susceptible to liquefaction while clayey soils generally are not susceptible to this phenomenon. The curves in Figure C7.4-3 are valid for soils composed primarily of sand. The curves should be used with caution for soils with substantial amounts of gravel. Verified corrections for gravel content have not been developed; a geotechnical engineer, experienced in liquefaction hazard evaluation, should be consulted when gravelly soils are encountered. For soils containing more than 35 percent fines, the curve in Figure C7.4-3 for 35 percent fines should be used provided the following criteria are met (Seed and Idriss, 1982; Seed et al., 1983): the weight of soil particles finer than 0.005 mm is less than 15 percent of the dry weight of a specimen of the soil; the liquid limit of soil is less than 35 percent; and the moisture content of the in-place soil is greater than 0.9 times the liquid limit. If these criteria are not met, the soils may be considered nonliquefiable.

Evaluation of potential for ground displacements. Liquefaction by itself may or may not be of engineering significance. Only when liquefaction is accompanied by loss of ground support and/or ground deformation does this phenomenon become important to structural design. Surface manifestations, loss of bearing strength, ground settlement, flow failure and lateral spread are ground failure mechanisms that have caused structural damage during past earthquakes. These types of ground failure are described in Martin and Lew (1999), U.S. Army Corps of Engineers (1998) and National Research Council (1985) and are discussed below. The type of failure and amount of ground displacement are a function of several parameters including the looseness of the liquefied soil layer, the thickness and extent of the liquefied layer, the thickness and permeability of unliquefied material overlying the liquefied layer, the ground slope, and the nearness of a free face.

Surface Manifestations. Surface manifestations refer to sand boils and ground fissures on level ground sites. For structures supported on shallow foundations, the effects of surface manifestations on the structure could be tilting or cracking. Criteria are given by Ishihara (1985) for evaluating the influence of thickness of layers on surface manifestation of liquefaction effects for level sites. These criteria may be used for noncritical or nonessential structures on level sites not subject to lateral spreads (see later in this section). Additional analysis should be performed for critical or essential structures.

Loss of bearing strength. Loss of bearing strength can occur if the foundation is located within or above the liquefiable layer. The consequence of bearing failure could be settlement or tilting of the structure. Usually, loss of bearing strength is not likely for light structures with shallow footings founded on stable, nonliquefiable materials overlying deeply buried liquefiable layers, particularly if the liquefiable layers are relatively thin. Simple guidance for how deep or how thin the layers must be has not yet been developed. Martin and Lew (1999) provide some preliminary guidance based on the Ishihara (1985) method. Final evaluation of the potential for loss of bearing strength should be made by a geotechnical engineer experienced in liquefaction hazard assessment

Ground settlement. For saturated or dry granular soils in a loose condition, the amount of ground settlement could approach 3 to 4 percent of the thickness of the loose soil layer in some cases. This amount of settlement could cause tilting or cracking of a building, and therefore, it is usually important to evaluate the potential for ground settlement during earthquakes.

Tokimatsu and Seed (1987) published an empirical procedure for estimating ground settlement. It is beyond the scope of this commentary to outline that procedure which, although explicit, has several rather complex steps. The Tokimatsu and Seed procedure can be applied whether liquefaction does or does not occur. For dry cohesionless soils, the settlement estimate from Tokimatsu and Seed should be multiplied by a factor of 2 to account for multi-directional shaking effects as discussed by Martin and Lew (1999).

Flow failures. Flow failures or flow slides are the most catastrophic form of ground failure that may be triggered when liquefaction occurs. They may displace large masses of soils tens of meters. Flow slides occur when the average static shear stresses on potential failure surfaces are less than the average shear strengths of liquefied soil on these surfaces. Standard limit equilibrium static slope stability analyses may be used to assess flow failure potential with the residual strength of liquefied soil used as the strength parameter in the analyses.

The determination of residual strengths is very inexact, and consensus as to the most appropriate approach has not been reached to date. Two relationships for residual strength of liquefied soil that are often used in practice are those of Seed and Harder (1990) and Stark and Mesri (1992). A more complete discussion and references on this topic may be found in Martin and Lew (1999).

Lateral spreads. Lateral spreads are ground-failure phenomena that can occur on gently sloping ground underlain by liquefied soil. They may result in lateral movements in the range of a few centimeters to several meters. Earthquake ground-shaking affects the stability of gently sloping ground containing liquefiable materials by seismic inertia forces combined with static gravity forces within the slope and by shaking-induced strength reductions in the liquefiable materials. Temporary instability due to seismic inertia forces are manifested by lateral “downslope” movement. For the duration of ground shaking associated with moderate-to large-magnitude earthquakes, there could be many such occurrences of temporary instability during earthquake shaking, producing an accumulation of “downslope” movement.

Various analytical and empirical techniques have been developed to date to estimate lateral spread ground displacement; however, no single technique has been widely accepted or verified for engineering design. Three approaches are used depending on the requirements of the project: empirical procedures, simplified analytical methods, and more rigorous computer modeling. Empirical procedures use correlations between past ground displacement and site conditions under which those displacements occurred. Youd et al. (2002) present an empirical method that provides an estimate of lateral spread displacements as a function of earthquake magnitude, distance, topographic conditions, and soil deposit characteristics. As shown in Figure C7.4-5, the displacements estimated by the Youd et al. (2002) method are generally within a factor of two of the observed displacements. Bardet et al. (2002) present an empirical method having a formulation similar to that of Youd et al. (2002) but using fewer parameters to describe the soil deposit. The Bardet et al. (2002) model was developed to assess lateral spread displacements at a regional scale rather than for site-specific applications.

Simplified analytical techniques generally apply some form of Newmark’s analysis of a rigid body sliding on an infinite or circular failure surface with ultimate shear resistance estimated from the residual strength of the deforming soil. Additional discussion of the simplified Newmark method is provided in Sec. 7.4.1. More rigorous computer modeling typically involves use of nonlinear finite element or finite difference methods to predict deformations, such as with the computer code FLAC. Both the simplified Newmark method and the rigorous computer codes require considerable experience to obtain meaningful results. For example, the soil model within the nonlinear computer codes is often calibrated for only specific conditions. If the site is not characterized by these conditions, errors in estimating the displacement by a factor of two or more can easily occur.

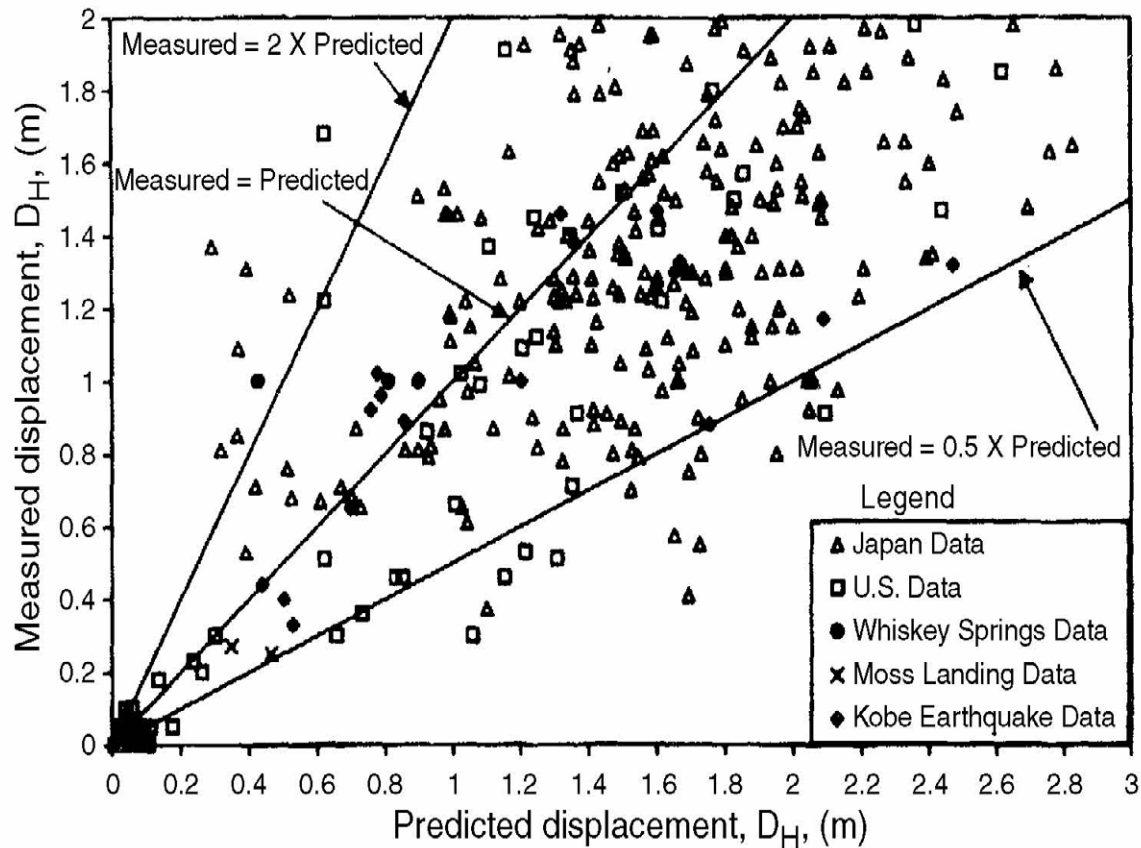

Figure C7.4-5. Measured versus predicted displacements for displacements up to 2 meters. (Youd et al., 2002).

Liquefaction-induced deformations are not directly proportional to ground motions and may be more than 50 percent higher for maximum considered earthquake ground motions than for design earthquake ground motions. The liquefaction potential and resulting deformations for ground motions consistent with the maximum considered earthquake should also be evaluated and, while not required in the *Provisions*, should be used by the registered design professional in checking for building damage that may result in collapse. In addition, Seismic Use Group III structures should be checked for their required post-earthquake condition.

Mitigation of liquefaction hazard. With respect to the hazard of liquefaction, three mitigative measures might be considered: design the structure to resist the hazard, stabilize the site to reduce the hazard, or choose an alternative site. Structural measures that are used to reduce the hazard include deep foundations, mat foundations, or footings interconnected with ties as discussed in Sec. 7.4.3. Deep foundations have performed well at level sites of liquefaction where effects were limited to ground settlement and ground oscillation with no more than a few inches of lateral displacement. Deep foundations, such as piles, may receive reduced soil support through the liquefied layer and may be subjected to transient lateral displacements across the layer. Well reinforced mat foundations also have performed well at localities where ground displacements were less than 1 ft, although re-leveling of the structure has been required in some instances (Youd, 1989). Strong ties between footings also should provide increased resistance to damage where differential ground displacements are less than a foot.

Evaluations of structural performance following two recent Japanese earthquakes, 1993 Hokkaido Nansei-Oki and 1995 (Kobe) Hyogo-Ken Nanbu, indicate that small structures on shallow foundations performed well in liquefaction areas. Sand boil eruptions and open ground fissures in these areas indicate minor effects of liquefaction, including ground oscillation and up to several tenths of a meter of lateral spread displacement. Many small structures (mostly houses, shops, schools, etc.) were

structurally undamaged although a few tilted slightly. Foundations for these structures consist of reinforced concrete perimeter wall footings with reinforced concrete interior wall footings tied into the perimeter walls at intersections. These foundations acted as diaphragms causing the soil to yield beneath the foundation which prevented fracture of foundations and propagation of differential displacements into the superstructure.

Similarly, well reinforced foundations that would not fracture could be used in U.S. practice as a mitigative measure to reduce structural damage in areas subject to liquefaction but with limited potential for lateral (< 0.3 m) or vertical (< 0.05 m) ground displacements. Such strengthening also would serve as an effective mitigation measure against damage from other sources of limited ground displacement including fault zones, landslides, and cut fill boundaries. Where slab-on-grade or basement slabs are used as foundation elements, these slabs should be reinforced and tied to the foundation walls to give the structure adequate strength to resist ground displacement. Although strengthening of foundations, as noted above, would largely mitigate damage to the structure, utility connections may be adversely affected unless special flexibility is built into these nonstructural components.

Another possible consequence of liquefaction to structures is increased lateral pressures against basement walls as discussed in Sec. 7.5.1. A common procedure used in design for such increased pressures is to assume that the liquefied material acts as a dense fluid having a unit weight of the liquefied soil. The wall then is designed assuming that hydrostatic pressure for the dense fluid acts along the total subsurface height of the wall. The procedure applies equivalent horizontal earth pressures that are greater than typical at-rest earth pressures but less than passive earth pressures. As a final consideration, to prevent buoyant rise as a consequence of liquefaction, the total weight of the structure should be greater than the volume of the basement or other cavity times the unit weight of liquefied soil. (Note that structures with insufficient weight to counterbalance buoyant effects could differentially rise during an earthquake.)

At sites where expected ground displacements are unacceptably large, ground modification to lessen the liquefaction or ground failure hazard or selection of an alternative site may be required. Techniques for ground stabilization to prevent liquefaction of potentially unstable soils include removal and replacement of soil; compaction of soil in place using vibrations, heavy tamping, compaction piles, or compaction grouting; buttressing; chemical stabilization with grout; and installation of drains. Further explanation of these methods is given by the National Research Council (1985).

Surface fault rupture hazard. Fault ruptures during past earthquakes have led to large surface displacements that are potentially destructive to engineered construction. Displacements, which range from a fraction of an inch to tens of feet, generally occur along traces of previously active faults. The sense of displacement ranges from horizontal strike-slip to vertical dip-slip to many combinations of these components. The following commentary summarizes procedures to follow or consider when assessing the hazard of surface fault rupture. Sources of detailed information for evaluating the hazard of surface fault rupture include Slemmons and dePolo (1986), the Utah Section of the Association of Engineering Geologists (1987), Swan et al. (1991), Hart and Bryant (1997), and California Geological Survey (2002). Other beneficial references are given in the bibliographies of these publications.

Assessment of surface faulting hazard. The evaluation of surface fault rupture hazard at a given site is based extensively on the concepts of recency and recurrence of faulting along existing faults. The magnitude, sense, and frequency of fault rupture vary for different faults or even along different segments of the same fault. Even so, future faulting generally is expected to recur along pre-existing active faults. The development of a new fault or reactivation of a long inactive fault is relatively uncommon and generally need not be a concern. For most engineering applications related to foundation design, a sufficient definition of an active fault is given in CDMG Special Publication 42 (Hart and Bryant, 1997): “An active fault has had displacement in Holocene time (last 11,000 years).”

As a practical matter, fault investigations should be conducted by qualified geologists and directed at the problem of locating faults and evaluating recency of activity, fault length, the amount and character of past displacements, and the expected amount and potential of future displacement. Identification and

characterization studies should incorporate evaluation of regional fault patterns as well as detailed study of fault features at and in the near vicinity (within a few hundred yards to a mile) of the site. Detailed studies often include trenching to accurately locate, document, and date fault features.

Suggested approach for assessing surface faulting hazard. The following approach should be used, or at least considered, in fault hazard assessment. Some of the investigative methods outlined below should be carried out beyond the site being investigated. However, it is not expected that all of the following methods would be used in a single investigation:

1. A review should be made of the published and unpublished geologic literature from the region along with records concerning geologic units, faults, ground-water barriers, etc.
2. A stereoscopic study of aerial photographs and other remotely sensed images should be made to detect fault-related topography/geomorphic features, vegetation and soil contrasts, and other lineaments of possible fault origin. The study of predevelopment aerial photographs is often essential to the detection of fault features.
3. A field reconnaissance study generally is required and should include observation and mapping of bedrock and soil units and structures, geomorphic surfaces, fault-related geomorphic features, springs, and deformation of man-made structures due to fault creep. Field study should be detailed within the site with less detailed reconnaissance of an area within a mile or so of the site.
4. Subsurface investigations usually are needed to evaluate location and activity of fault traces. These investigations may include trenches, test pits, and/or boreholes to permit detailed and direct observation of geologic units and faults.
5. The geometry of faults may be further defined by geophysical investigations including seismic refraction, seismic reflection, gravity, magnetic intensity, resistivity, ground penetrating radar, etc. These indirect methods require a knowledge of specific geologic conditions for reliable interpretation. Geophysical methods alone never prove the absence of a fault and they typically do not identify the recency of activity.
6. More sophisticated and more costly studies may provide valuable data where geological special conditions exist or where requirements for critical structures demand a more intensive investigation. These methods might involve repeated geodetic surveys, strain measurements, or monitoring of microseismicity and radiometric analysis (C^{14} , K-Ar), stratigraphic correlation (fossils, mineralogy) soil profile development, paleomagnetism (magnetostratigraphy), or other dating techniques (thermoluminescence, cosmogenic isotopes) to date the age of faulted or unfaulted units or surfaces. Probabilistic studies may be considered to evaluate the probability of fault displacement (Youngs et al., 2003).

The following information should be developed to provide documented support for conclusions relative to location and magnitude of faulting hazards:

1. Maps should be prepared showing the existence (or absence) and location of hazardous faults on or near the site. The distribution of primary and secondary faulting (fault zone width) and fault-related surface deformation should be shown.
2. The type, amount, and sense of displacement of past surface faulting episodes should be documented, if possible.
3. From this documentation, estimates of location, magnitude, and likelihood or relative potential for future fault displacement can be made, preferably from measurements of past surface faulting events at the site, using the premise that the general pattern of past activity will repeat in the future. Estimates also may be made from empirical correlations between fault displacement and fault length or earthquake magnitude published by Wells and Coppersmith (1994). Where fault segment length and sense of displacement are defined, these correlations may provide an estimate of future fault displacement (either the maximum or the average to be expected).
4. The degree of confidence and limitations of the data should be addressed.

There are no codified procedures for estimating the amount or probability of future fault displacements. Estimates may be made, however, by qualified earth scientists using techniques described above. Because techniques for making these estimates are not standardized, peer review of reports is useful to verify the adequacy of the methods used and the estimates reports, to aid the evaluation by the permitting agency, and to facilitate discussion between specialists that could lead to the development of standards.

The following guidelines are given for safe siting of engineered construction in areas crossed by active faults:

1. Where ordinances have been developed that specify safe setback distances from traces of active faults or active fault zones, those distances must be complied with and accepted as the minimum for safe siting of buildings. For example, the general setback requirement in California is a minimum of 50 ft from a well-defined zone containing the traces of an active fault. That setback distance is mandated as a minimum for structures near faults unless a site-specific special geologic investigation shows that a lesser distance could be safely applied (*California Code of Regulations*, Title 14, Division 2, Sec. 3603(a)).
2. In general, safe setback distances may be determined from geologic studies and analyses as noted above. Setback requirements for a site should be developed by the site engineers and geologists in consultation with professionals from the building and planning departments of the jurisdiction involved. Where sufficient geologic data have been developed to accurately locate the zone containing active fault traces and the zone is not complex, a 50-ft setback distance may be specified. For complex fault zones, greater setback distances may be required. Dip-slip faults, with either normal or reverse motion, typically produce multiple fractures within rather wide and irregular fault zones. These zones generally are confined to the hanging-wall side of the fault leaving the footwall side little disturbed. Setback requirements for such faults may be rather narrow on the footwall side, depending on the quality of the data available, and larger on the hanging wall side of the zone. Some fault zones may contain broad deformational features such as pressure ridges and sags rather than clearly defined fault scarps or shear zones. Nonessential structures may be sited in these zones provided structural mitigative measures are applied as noted below. Studies by qualified geologists and engineers are required for such zones to assure that building foundations can withstand probable ground deformations in such zones.

Mitigation of surface faulting hazards. There is no mitigative technology that can be used to prevent fault rupture from occurring. Thus, sites with unacceptable faulting hazard must either be avoided or structures designed to withstand ground deformation or surface fault rupture. In general practice, it is economically impractical to design a structure to withstand more than a few inches of fault displacement. Some buildings with strong foundations, however, have successfully withstood or diverted a few inches of surface fault rupture without damage to the structure (Youd, 1989; Kelson et al., 2001). Well reinforced mat foundations and strongly inter-tied footings have been most effective. In general, less damage has been inflicted by compressional or shear displacement than by vertical or extensional displacements.

7.4.2 Pole-type structures. The use of pole-type structures is permitted. These structures are inherently sensitive to earthquake motions. Bending in the poles and the soil capacity for lateral resistance of the portion of the pole embedded in the ground should be considered and the design completed accordingly.

7.4.3 Foundation ties. One of the prerequisites of adequate performance of a building during an earthquake is the provision of a foundation that acts as a unit and does not permit one column or wall to move appreciably with respect to another. A common method used to attain this is to provide ties between footings and pile caps. This is especially necessary where the surface soils are soft enough to require the use of piles or caissons. Therefore, the pile caps or caissons are tied together with nominal ties capable of carrying, in tension or compression, a force equal to $S_{DS}/10$ times the larger pile cap or column load.

A common practice in some multistory buildings is to have major columns that run the full height of the building adjacent to smaller columns in the basement that support only the first floor slab. The coefficient applies to the heaviest column load.

Alternate methods of tying foundations together are permitted (such as using a properly reinforced floor slab that can take both tension and compression). Lateral soil pressure on pile caps is not a recommended method because the motion is imparted from soil to structure (not inversely as is commonly assumed), and if the soil is soft enough to require piles, little reliance can be placed on soft-soil passive pressure to restrain relative displacement under dynamic conditions.

If piles are to support structures in the air or over water (such as in a wharf or pier), batter piles may be required to provide stability or the piles may be required to provide bending capacity for lateral stability. It is up to the foundation engineer to determine the fluidity or viscosity of the soil and the point where lateral buckling support to the pile can be provided (that is, the point where the flow of the soil around the piles may be negligible).

7.4.4 Special pile requirements. Special requirements for piles, piers, or caissons in Seismic Design Category C are given in this section. Provisions for pile anchorage to the pile cap or grade beam and transverse reinforcement detailing requirements for concrete piles are provided. The anchorage requirements are intended to assure that the connection to the pile cap does not fail in a brittle manner under moderate ground motions. Moderate ground motions could result in pile tension forces or bending moments which could compromise shallow anchorage embedment. Shallow anchorages in pile caps may consist of short lengths of reinforcing bars or bare structural steel pile sections. Loss of pile anchorage could result in unintended increases in vertical seismic force resisting element drifts from rocking, potential overturning instability of the superstructure, and loss of shearing resistance at the ground surface. Anchorage by shallow embedment of the bare steel pile section is not recommended due to the degradation of the concrete bond from cracking as a result of the cyclic loading from the moderate ground motions. Exception to this is permitted for steel pipe piles filled with concrete when the connection is made with reinforcing bar dowels properly developed into the pile and pile cap. The confinement of the interior concrete by the “hoop” stresses of the circular pile section was judged to be sufficient to prevent concrete pullout from that section. Using this method of connection, the structural steel pipe section should be embedded into the pile cap for a short distance or else the pile should be designed as an uncased concrete pile. End anchorage detailing requirements for transverse reinforcement generally follow that required by ACI 318, Chapter 21 to assure that no loss of confinement of the transverse reinforcement occurs in concrete piles since verification of pile damage after moderate ground motions is difficult or not done.

7.4.4.1 Uncased concrete piles. The uncased concrete piles category has been expanded to include auger-cast piles which are now subject to the same reinforcement requirements as other cast-in-place concrete piles. The longitudinal reinforcement within a pile has prescriptive termination point minimums intended for firm soils and is required to extend at least the full flexural length. The longitudinal reinforcement should extend past the flexural length by its development length requirement. The flexural length has been defined as that length of a pile from bottom of pile cap to a point where 0.4 times the concrete section cracking moment exceeds the calculated flexural demand. The 0.4 factor is analogous to a material resistance factor in strength design. This definition implies the plain concrete section will be resisting some minimal amount of moment demand beyond the “flexural” length. Where the pile is subject to significant uplift forces, it is recommended that the longitudinal reinforcement extend the full length of the pile.

Increased transverse reinforcement requirements are given for the potential plastic hinge zone immediately below the pile cap. The potential plastic hinge zone was taken to be three pile diameters below the pile cap to allow for varied soil site classes. The transverse reinforcement detailing for this zone is similar to that required for concrete intermediate moment frames at hinge regions and is expected to provide a displacement ductility of approximately 4. Beyond the potential plastic hinge region, the curvature ductility demand is not considered to exceed that provided by the nominal moment capacity of the section for non-earthquake loads.

7.4.4.4 Precast (non-prestressed) concrete piles. For precast concrete piles, the longitudinal reinforcement is specified to extend the full length of the pile so there is no need to determine the flexural length. Transverse reinforcement spacing within the potential plastic hinge zone is required for the length of three pile diameters at the bottom of pile cap. Particular attention should be taken where piles cannot be driven to or are overdriven beyond the anticipated end bearing point elevation. The transverse reinforcement size and spacing in this region is the same as the uncased concrete pile. Transverse reinforcement spacing outside the potential plastic hinge zone is specified to be no greater than 8 inches to conform with current building code minimums for this pile type.

7.4.4.5 Precast-prestressed piles. The transverse reinforcement requirements are primarily taken from the PCI Committee Report (1993) on precast prestressed concrete piling for geographic regions subject to low to moderate ground motions. The amount of transverse reinforcement was relaxed for the pile region greater than 20 feet (6m) below the pile cap to one-half of that required above. It was judged that the reduced transverse reinforcement would be sufficient to resist the reduced curvature demands at that point. Particular attention should be taken where piles cannot be driven to or are overdriven beyond the anticipated end bearing point elevation so that the length of the confining transverse reinforcement is maintained.

Equation (7.4-1), originally from ACI 318, has always been intended to be a lower bound spiral transverse reinforcement ratio for larger diameter columns. It is independent of the member section properties and can therefore be applied to large or small diameter piles. For cast-in-place piles and prestressed concrete piles, the resulting spiral reinforcement ratios from this formula are considered to be sufficient to provide moderate ductility capacities.

High strength hard drawn wire with higher yield strengths is permitted to be used for transverse circular spiral reinforcement of precast prestressed concrete piles. Pile test specimens using this type of transverse reinforcement include the research done by Park and Hoat Joen (1990). High strength hard drawn wire has yield strengths between 150 and 200 ksi. f_{yh} is conservatively limited to 85 ksi for this steel because hard drawn wire has limited ductility.

7.5 SEISMIC DESIGN CATEGORIES D, E, AND F

For Seismic Design Category D, E, or F construction, all the preceding provisions for Seismic Design Category C applies for the foundations, but the earthquake detailing is generally more severe and demanding.

7.5.1 Investigation. In addition to the potential site hazards discussed in *Provisions* Sec. 7.4.1, consideration of lateral pressures on earth retaining structures shall be included in investigations for Seismic Design Categories D, E, and F.

Earth retaining structures. Increased lateral pressures on retaining structures during earthquakes have long been recognized; however, design procedures have not been prescribed in U.S. model building codes. Waterfront structures often have performed poorly in major earthquake due to excess pore water pressure and liquefaction conditions developing in relatively loose, saturated granular soils. Damage reports for structures away from waterfronts are generally limited with only a few cases of stability failures or large permanent movements (Whitman, 1991). Due to the apparent conservatism or overstrength in static design of most walls, the complexity of nonlinear dynamic soil-structure interaction, and the poor understanding of the behavior of retaining structures with cohesive or dense granular soils, Whitman (1991) recommends that “engineers must rely primarily on a sound understanding of fundamental principles and of general patterns of behavior.”

Seismic design analysis of retaining walls is discussed below for two categories of walls: “yielding” walls that can move sufficiently to develop minimum active earth pressures and “nonyielding” walls that do not satisfy this movement condition. The amount of movement to develop minimum active pressure is very small. A displacement at the top of the wall of 0.002 times the wall height is typically sufficient to develop the minimum active pressure state. Generally, free-standing gravity or cantilever

walls are considered to be yielding walls (except massive gravity walls founded on rock), whereas building basement walls restrained at the top and bottom are considered to be nonyielding.

Yielding walls. At the 1970 Specialty Conference on Lateral Stresses in the Ground and Design of Earth Retaining Structures, Seed and Whitman (1970) made a significant contribution by reintroducing and reformulating the Monobe-Okabe (M-O) seismic coefficient analysis (Monobe and Matsuo, 1929; Okabe, 1926), the earliest method for assessing the dynamic lateral pressures on a retaining wall. The M-O method is based on the key assumption that the wall displaces or rotates outward sufficiently to produce the minimum active earth pressure state. The M-O formulation is expressed as:

$$P_{AE} = (1/2)\gamma H^2 (1 - k_v) K_{AE} \quad (C7.5-1)$$

where: P_{AE} is the total (static + dynamic) lateral thrust, γ is unit weight of backfill soil, H is height of backfill behind the wall, k_v is vertical ground acceleration divided by gravitational acceleration, and K_{AE} is the static plus dynamic lateral earth pressure coefficient which is dependent on (in its most general form) angle of friction of backfill, angle of wall friction, slope of backfill surface, and slope of back face of wall, as well as horizontal and vertical ground acceleration. The formulation for K_{AE} is given in textbooks on soil dynamics (Prakash, 1981; Das, 1983; Kramer, 1996) and discussed in detail by Ebeling and Morrison (1992).

Seed and Whitman (1970), as a convenience in design analysis, proposed to evaluate the total lateral thrust, P_{AE} , in terms of its static component (P_A) and dynamic incremental component (ΔP_{AE}):

$$P_{AE} = P_A + \Delta P_{AE} \quad (C7.5-2a)$$

or

$$K_{AE} = K_A + \Delta K_{AE} \quad (C7.5-2b)$$

or

$$\Delta P_{AE} = (1/2)\gamma H^2 \Delta K_{AE} \quad (C7.5-2c)$$

Seed and Whitman (1970), based on a parametric sensitivity analysis, further proposed that for practical purposes:

$$\Delta K_{AE} = (3/4)K_h \quad (C7.5-3a)$$

$$\Delta P_{AE} = (1/2)\gamma H^2 (3/4)k_h = (3/8)k_h \gamma H^2 \quad (C7.5-3b)$$

where k_h is horizontal ground acceleration divided by gravitational acceleration. It is recommended that k_h be taken equal to the site peak ground acceleration that is consistent with design earthquake ground motions as determined in *Provisions* Sec. 7.5.2 (that is, $k_h = S_{DS}/2.5$). Eq. C7.5-3a and C7.5-3b generally are referred to as the simplified M-O formulation.

Since its introduction, there has been a consensus in geotechnical engineering practice that the simplified M-O formulation reasonably represents the dynamic (seismic) lateral earth pressure increment for yielding retaining walls. For the distribution of the dynamic thrust, ΔP_{AE} , Seed and Whitman (1970) recommended that the resultant dynamic thrust act at $0.6H$ above the base of the wall (that is, inverted trapezoidal pressure distribution).

Using the simplified M-O formulation, a yielding wall may be designed using either a limit-equilibrium force approach (conventional retaining wall design) or an approach that permits movement of the wall up to tolerable amounts. Richards and Elms (1979) introduced a method for seismic design analysis of yielding walls considering translational sliding as a failure mode and based on tolerable permanent displacements for the wall. There are a number of empirical formulations for estimating permanent displacements under a translation mode of failure; these have been reviewed by Whitman and Liao (1985). Nadim (1980) and Nadim and Whitman (1984) incorporated the failure mode of wall tilting as well as sliding by employing coupled equations of motion, which were further formulated by

Siddharthan et al. (1992) as a design method to predict the seismic performance of retaining walls taking into account both sliding and tilting. Alternatively, Prakash and others (1995) described design procedures and presented design charts for estimating both sliding and rocking displacements of rigid retaining walls. These design charts are the results of analyses for which the backfill and foundation soils were modeled as nonlinear viscoelastic materials. A simplified method that considers rocking of a wall on a rigid foundation about the toe was described by Steedman and Zeng (1996) and allows the determination of the threshold acceleration beyond which the wall will rotate. A simplified procedure for evaluating the critical threshold accelerations for sliding and tilting was described by Richards and others (1996).

Application of methods for evaluating tilting of yielding walls has been limited to a few case studies and back-calculation of laboratory test results. Evaluation of wall tilting requires considerable engineering judgment. Because the tilting mode of failure can lead to instability of a yielding retaining wall, it is suggested that this mode of failure be avoided in the design of new walls by proportioning the walls to prevent rotation in order to displace only in the sliding mode.

Nonyielding walls. Wood (1973) analyzed the response of a rigid nonyielding wall retaining a homogeneous linear elastic soil and connected to a rigid base. For such conditions, Wood established that the dynamic amplification was insignificant for relatively low-frequency ground motions (that is, motions at less than half of the natural frequency of the unconstrained backfill), which would include many or most earthquake problems.

For uniform, constant k_h applied throughout the elastic backfill, Wood (1973) developed the dynamic thrust, ΔP_E , acting on smooth rigid nonyielding walls as:

$$\Delta P_E = F k_h \gamma H^2 \quad (\text{C7.5-4a})$$

The value of F is approximately equal to unity (Whitman, 1991) leading to the following approximate formulation for a rigid nonyielding wall on a rigid base:

$$\Delta P_E = k_h \gamma H^2 \quad (\text{C7.5-4b})$$

As for yielding walls, the point of application of the dynamic thrust is taken typically at a height of $0.6H$ above the base of the wall.

It should be noted that the model used by Wood (1973) does not incorporate any effect on the pressures of the inertial response of a superstructure connected to the top of the wall. This effect may modify the interaction between the soil and the wall and thus modify the pressures from those calculated assuming a rigid wall on a rigid base. The subject of soil-wall interaction is addressed in the following sections. This section also provides further discussion on the applicability of the Wood and the M-O formulations.

Soil-structure-interaction approach and modeling for wall pressures. Lam and Martin (1986), Soydemir and Celebi (1992), Veletsos and Younan (1994a and 1994b), and Ostadan and White (1998), among others, argue that the earth pressures acting on the walls of embedded structures during earthquakes are primarily governed by soil-structure interaction (SSI) and, thus, should be treated differently from the concept of limiting equilibrium (that is, M-O method). Soil-structure interaction includes both a kinematic component—the interaction of a massless rigid wall with the adjacent soil as modeled by Wood (1973)—and an inertial component—the interaction of the wall, connected to a responding superstructure, with the adjacent soil. Detailed SSI analyses incorporating kinematic and inertial interaction may be considered for the estimation of seismic earth pressures on critical walls. Computer programs that may be utilized for such analyses include FLUSH (Lysmer et. al, 1975) and SASSI (Lysmer et al., 1981).

Ostadan and White (1998) have observed that for embedded structures subjected to ground shaking, the characteristics of the wall pressure amplitudes vs. frequency of the ground motion were those of a single-degree-of-freedom (SDOF) system and proposed a simplified method to estimate the magnitude

and distribution of dynamic thrust. Results provided by Ostadan and White (1998) utilizing this simplified method, which were also confirmed by dynamic finite element analyses, indicate that, depending on the dynamic properties of the backfill as well as the frequency characteristics of the input ground motion, a range of dynamic earth pressure solutions would be obtained for which the M-O solution and the Wood (1973) solution represent a “lower” and an “upper” bound, respectively.

Chang and others (1990) have found that dynamic earth pressures recorded on the wall of a model nuclear reactor containment building were consistent with dynamic pressures predicted by the M-O solution. Analysis by Chang and others indicated that the dynamic wall pressures were strongly correlated with the rocking response of the structure. Whitman (1991) has suggested that SSI effects on basement walls of buildings reduce dynamic earth pressures and that M-O pressures may be used in design except where structures are founded on rock or hard soil (that is, no significant rocking). In the latter case, the pressures given by the Wood (1973) formulation would appear to be more applicable. The effect of rocking in reducing the dynamic earth pressures on basement walls also has been suggested by Ostadan and White (1998). This condition may be explained if it is demonstrated that the dynamic displacements induced by kinematic and inertial components are out of phase.

Effect of saturated backfill on wall pressures. The previous discussions are limited to backfills that are not water-saturated. In current (1999) practice, drains typically are incorporated in the design to prevent groundwater from building up within the backfill. This is not practical or feasible, however, for waterfront structures (such as quay walls) where most of the earthquake-induced failures have been reported (Seed and Whitman, 1970; Ebeling and Morrison, 1992; ASCE-TCLEE, 1998).

During ground shaking, the presence of water in the pores of a backfill can influence the seismic loads that act on the wall in three ways (Ebeling and Morrison, 1992; Kramer, 1996): (1) by altering the inertial forces within the backfill, (2) by developing hydrodynamic pressures within the backfill and (3) by generating excess porewater pressure due to cyclic straining. Effects of the presence of water in cohesionless soil backfill on seismic wall pressures can be estimated using formulations presented by Ebeling and Morrison (1992).

A soil liquefaction condition behind a wall may under the design earthquake have a pronounced effect on the wall pressures during and for some time after the earthquake. At present (1999), there is no general consensus established for estimating lateral earth pressures for liquefied backfill conditions. One simplified and probably somewhat conservative approach is to treat the liquefied backfill as a heavy viscous fluid exerting a hydrostatic pressure on the wall. In this case, the viscous fluid has the total unit weight of the liquefied soil. If unsaturated soil is present above the liquefied soil, it is treated as a surcharge that increases the fluid pressure within the underlying liquid soil by an amount equal to the thickness times the total unit weight of the surcharge soil. In addition to these “static” fluid pressures exerted by a liquefied backfill, hydrodynamic pressures can be exerted by the backfill. The magnitude of any such hydrodynamic pressures would depend on the level of shaking following liquefaction. Hydrodynamic effects may be estimated using formulations presented by Ebeling and Morrison (1992).

7.5.3 Foundation ties. The additional requirement is made that spread footings on soft soil profiles should be interconnected by ties. The reasoning explained above under Sec. 7.4.3 also applies here.

7.5.4 Special pile and grade beam requirements. For Seismic Design Categories D, E, and F, additional pile reinforcement over that specified for Seismic Design Category C buildings is required. Adequate pile ductility is required and provision must be made for additional reinforcement to ensure, as a minimum, full ductility in the upper portion of the pile.

Special consideration is required in the design of concrete piles subject to significant bending during earthquake shaking. Bending can become crucial to pile design where portions of the foundation piles are supported in soils such as loose granular materials and/or soft soils that are susceptible to large deformations and/or strength degradation. Severe pile bending problems may result from various combinations of soil conditions during strong ground shaking, for example:

1. Soil settlement at the pile-cap interface either from consolidation of soft soil prior to the earthquake or from soil compaction during the earthquake can create a free-standing short column adjacent to the pile cap.
2. Large deformations and/or reduction in strength resulting from liquefaction of loose granular materials can cause bending and/or conditions of free-standing columns.
3. Large deformations in soft soils can cause varying degrees of pile bending. The degree of pile bending will depend upon thickness and strength of the soft soil layer(s) and/or the properties of the soft/stiff soil interface(s).

Such conditions can produce shears and/or curvatures in piles that may exceed the bending capacity of conventionally designed piles and result in severe damage. Analysis techniques to evaluate pile bending are discussed by Margason and Holloway (1977) and Mylonakis (2001) and these effects on concrete piles are further discussed by Shepard (1983). For homogeneous, elastic media and assuming the pile follows the soil, the free-field curvature (soil strains without a pile present) can be estimated by dividing the peak ground acceleration by the square of the shear wave velocity of the soil, although considerable judgment is necessary in utilizing this simple relationship in a layered, inelastic profile with pile-soil interaction effects. Norris (1994) discusses methods to assess pile-soil interaction with regard to pile foundation behavior.

The designer needs to consider the variation in soil conditions and driven pile lengths in providing for pile ductility at potential high curvature interfaces. Interaction between the geotechnical and structural engineers is essential.

It is prudent to design piles to remain functional during and following earthquakes in view of the fact that it is difficult to repair foundation damage. The desired foundation performance can be accomplished by proper selection and detailing of the pile foundation system. Such design should accommodate bending from both reaction to the building's inertial loads and those induced by the motions of the soils themselves. Examples of designs of concrete piles include:

1. Use of a heavy spiral reinforcement and
2. Use of exterior steel liners to confine the concrete in the zones with large curvatures or shear stresses.

These provide proper confinement to ensure adequate ductility and maintenance of functionality of the confined core of the pile during and after the earthquake.

Design of piles incorporates the same R force reduction factor as the superstructure and therefore implies inelasticity in the foundations and piles. Therefore, piles should be designed with similar ductility requirements as the superstructure. Foundations in SDC D, E, and F are expected to experience strong ground motions and large pile curvatures. Inertial pile-soil-structure interaction may produce plastic hinging in the piles near the bottom of the pile cap. Kinematic soil-pile-structure interaction will result in some bending moments and shearing forces throughout the length of the pile and will be higher at interfaces between stiff and soft soil strata. Inertial pile-soil-structure interaction will be particularly severe in soft soils and liquefiable soils located near the pile cap. This could result in plastic hinging of the pile in reverse curvature near the pile cap and for this reason the potential plastic hinge region is extended to seven pile diameters from the pile cap in the *Provisions*.

Precast prestressed concrete piles are exempted from the concrete special moment frame detailing requirements adapted for concrete piles since these provisions were never intended for slender precast prestressed concrete elements and will result in unbuildable piles. Piles with substantially less confinement reinforcement than required by ACI 318 equation 10-6 have been proven through cyclic testing to have adequate performance (Park and Hoat Joen, 1990). Transverse steel requirements for the precast prestressed concrete piles are given in Section 7.5.4.4.

Where grade beams have the strength to resist the load combination with overstrength, which simulates

expected foundation demands under a yielding structure, detailing similar to the beams of the Special Moment Frame is not required. This “strong grade beam” provision could apply to both cantilever column systems and frame systems with the objective of avoiding the inelastic response or plastic hinging of the grade beam where it would be difficult to detect and repair after being subjected to strong ground motions.

Anchorage of the pile to the pile cap should be designed to permit energy dissipating mechanisms, such as pile slip at the pile-soil-interface, while maintaining a competent connection to the pile cap. A “least” capacity design approach is used for this purpose based on the pile section strength, not to exceed the load combination with overstrength, which simulates expected foundation demands under a yielding structure. A similar approach is also used for pile splice design.

Provisions are given to establish requirements as to when different pile analysis methods should be used. Short piles and long slender piles embedded in the earth behave differently when subject to lateral forces and displacements. Long slender pile response depends on its interaction with the soil considering the non-linear response of the soil. Long slender piles should be analyzed for lateral loads considering the nonlinear interaction of the shaft and soil. The nonlinearity is typically considered in the soil and not the pile. Numerous design aid curves and computer programs are available for this type of analysis, and such an analysis is not uncommon in practice (e.g. Ensoft, 2000a). This type of analysis is necessary to obtain realistic pile moments, forces and deflections. More sophisticated analyses which also consider nonlinear behavior or plastic hinging in the pile itself as well as nonlinearity in the soil for actual earthquake ground motions is still in the research realm. For pile length-to-diameter ratios less than or equal to 6, the pile can be treated as a rigid body simplifying the analysis. A method assuming a rigid body and linear soil response for lateral bearing is in current building codes. A more accurate and comprehensive approach using this method is given in a study by Czerniak (1957).

The effects of groups of piles, where closely spaced, should be taken into account for the soil vertical and horizontal response. As groups of closely spaced piles move laterally, failure zones for individual piles overlap and horizontal strength and stiffness response of the pile-soil system is reduced. Reduction factors or “*p-multipliers*” are needed to account for these groups of closely spaced piles. For a pile center-to-center spacing of three pile diameters, reduction factors of 0.6 for the leading pile row and 0.4 for the trailing pile rows are recommended by Rollins et al. (1999). Computer programs are available to analyze group effects, (e.g. Ensoft, 2000b).

Batter pile systems that are partially embedded have historically performed poorly under strong ground motions (Gerwick and Fotinos, 1992). Failure of battered piles has been attributed to neglecting the potential loading on the piles from ground deformation and also to an erroneous assumption that the lateral loads will be resisted by the axial response of piles leading to neglect of the induced moments in the pile at the pile cap (Lam and Bertero, 1990). Difficulties in examining fully embedded batter piles have led to uncertainties of the extent of damage for this type of foundation. Batter piles are considered as limited ductile systems by their nature and should be designed using the load combination with overstrength. Due to eccentricities inherent in batter pile configurations, moment resisting connections to the pile cap are required to resolve the statics. Otherwise the superstructure will have to resolve the eccentricities by resisting moments induced by the foundation under lateral forces. This concept is clearly illustrated in EQE Engineering (1991).

7.5.4.1 Uncased concrete piles. The uncased concrete piles category has been expanded to include auger-cast piles which are now subject to the same reinforcement requirements as other cast-in-place concrete piles. The longitudinal reinforcement within a pile has prescriptive termination point minimums intended for firm soils and is required to extend at least the full flexural length. The longitudinal reinforcement should extend past the flexural length by its development length requirement. The flexural length has been defined as that length of a pile from bottom of pile cap to a point where 0.4 times the concrete section cracking moment exceeds the calculated flexural demand. The 0.4 factor is analogous to a material resistance factor in strength design. This definition implies the plain concrete section will be resisting some minimal amount of moment demand beyond the “flexural” length. Where the pile is subject to significant uplift forces, it is recommended that the longitudinal

reinforcement extend the full length of the pile.

Increased transverse reinforcement requirements are given for the potential plastic hinge zone immediately below the pile cap and for regions beyond that zone. The potential plastic hinge zone was taken to be three pile diameters below the pile cap to allow for the varied soil site classes from A through D. For soil site classes E and F, the potential plastic hinge zone is taken to be seven diameters in length as given in Section 7.5.4. The transverse reinforcement detailing for these zones is similar to that required for concrete Special Moment Frames at hinge regions and is expected to provide a displacement ductility of approximately 5 to 6 depending upon the axial load. However, recent studies and testing has substantiated that the soil will contribute substantially to the confinement of the concrete pile section in firm soils. Chai and Hutchison (1998) found that in-situ lateral load testing of 16 inch diameter conventionally reinforced circular piles performed to displacement ductilities from approximately 3 to 4 using a spiral steel reinforcement ratio of 0.0057. Further testing of the same piles but with a spiral steel reinforcement ratio of 0.0106 produced improved displacement ductilities and no spiral fracture failure which occurred in the prior piles tested with the lower spiral ratio. These circular spiral ratios are considerably less than those required by ACI 318 for columns in Seismic Design Category D. ACI 318 equation 10-6 would require a spiral reinforcement ratio of at least 0.0175 depending on the concrete core diameter. Budek, Benzoni and Priestley (1997) found that testing of 24 inch diameter circular conventionally reinforced concrete piles with a transverse (circular) reinforcement ratio of 0.006 offered adequate performance up to a displacement ductility of 4. Their conclusions indicate that the soil confinement can play a significant role in the pile shaft response. As a result of these studies, full confinement reinforcement intended for superstructure columns is not necessary for in-ground pile foundations, except for soil site classes E and F and liquefiable soils. Beyond the potential plastic hinge region, the curvature ductility demand is not considered to exceed that provided by the nominal moment capacity of the section for nominal earthquake loads.

7.5.4.4 Precast-prestressed piles. The transverse reinforcement requirements are primarily taken from the PCI Committee Report (1993) on precast prestressed concrete piling for geographic regions subject to strong ground motions. The circular spiral transverse reinforcement equations recommended for precast prestressed concrete piles given in Park and Hoat Joen (1990) are the basis for the provisions. These equations make the curvature ductility capacity dependent on the pile axial load. A reduction of 50% in the normally required circular spiral reinforcement from those equations (similar to ACI 318 equation 10-6) was sufficient to achieve a displacement ductility of 4. The reduced circular spiral transverse reinforcement requirement is the basis for the PCI Piling Committee's final provisions.

High strength hard drawn wire with higher yield strengths is permitted to be used for transverse circular spiral reinforcement of precast prestressed concrete piles. Pile test specimens using this type of transverse reinforcement include the research done by Park and Hoat Joen (1990). High strength hard drawn wire has yield strengths between 150 and 200 ksi. f_{yh} is conservatively limited to 85 ksi for this steel because hard drawn wire has limited ductility.

7.5.4.5 Steel Piles. AISC Seismic (2002), Part I, Section 8.6 provides seismic design and detailing provisions for steel H-piles which should be used in conjunction with these provisions.

REFERENCES

- AISC, 2002, "*Seismic Provisions for Structural Steel Buildings*", American Institute of Steel Construction, Chicago, Illinois.
- American Society of Civil Engineers, Technical Committee on Lifeline Earthquake Engineering. 1998. *Seismic Guidelines for Ports*, edited by S. D. Werner, Monograph 12.
- Bardet, J.P., Tobita, T., Mace, N., and Hu, J., 2002, Regional modeling of liquefaction-induced ground deformation, *Earthquake Spectra*, 18(1), 19-46.
- Blake, T.F., Hollingsworth, R.A., and Stewart, J.P., editors 2002, Recommended procedures for implementation of DMG Special Publication 117 Guidelines for analyzing and mitigating landslide

- hazards in California, Southern California Earthquake Center, University of Southern California, Los Angeles, California, 130 p.
- Bray, J.D., and Rathje, E.M. 1998, Earthquake-induced displacements of solid-waste landfills, *Journal of Geotechnical and Geoenvironmental Engrg.*, ASCE, 124, 242-253.
- Budek, A., Benzoni, G. and Priestley, M.J.N., 1997, "The Effect of External Confinement and Transverse Reinforcement on Plastic Hinges in Cast-in-place Pile Shafts - Experimental Results", Report No. SSRP - 97/04, University of California, San Diego.
- California Department of Conservation, Division of Mines and Geology, 1997, Guidelines for Evaluating and Mitigating Seismic Hazards in California.
- California Geological Survey, 2002, Guidelines for evaluating the hazard of surface fault rupture: California Geological Survey Note 49, 4 p.
- Chai, Y. H. and Hutchison, T. C., "Large Scale Lateral Load Tests of Reinforced Concrete Bridge Piles in Cohesionless Soil", SEAOC 1998 Convention Proceedings.
- Chang, C. Y., M. S. Power, C. M. Mok, Y. K. Tang, and H. T. Tang. 1990. "Analysis of Dynamic Lateral Earth Pressures Recorded on Lotung Reactor Containment Model Structure," in *Proceedings, Fourth U.S. National Conference on Earthquake Engineering*, pp. 643-652. EERI.
- Czerniak, E., "Resistance to Overturning of Single Short Piles", 1957, ASCE Journal of the Structural Division, Vol 83, ST-2.
- Das, B. M. 1983. *Fundamentals of Soil Dynamics*. New York: Elsevier.
- Ebeling, R. M., and E. E. Morrison. 1992. *The Seismic Design of Waterfront Retaining Structures*, Technical Report ITL-92-11. Vicksburg, Mississippi: Corps of Engineers Waterways Experiment Station.
- Ensoft, Inc., 2000b, Computer Program GROUP, Version 5.0, A Program for the Analysis of a Group of Piles Subjected to Axial and Lateral Loading, User's Manual and Technical Manual, Austin, Texas.
- Ensoft, Inc., 2000a, Computer Program LPILE Plus Version 4.0, A Program for the Analysis of Piles and Drilled Shafts under Lateral Loads, User's Manual and Technical Manual, Austin, Texas.
- EQE Engineering ,1991 "Structural Concepts and Details for Seismic Design", UCRL-CR-106554, Dept. of Energy.
- Franklin, A.G. and Chang, F.K., 1977, "Earthquake Resistance of Earth and Rock-Fill Dams; Permanent Displacements of Earth Embankments by Newmark Sliding Block Analysis," Miscellaneous Paper S-71-17, Report 5, U.S. Army Waterways Experiment Station, CE, Vicksburg, MS.
- Gerwick, Jr., B., Fotinos, G., 1992, "Drilled Piers and Driven Piles for Foundations in Areas of High Seismicity", SEAONC Fall Seminar, October 29.
- Goodman, R.E. and Seed, H.B., 1966, Earthquake-induced displacements in Sand embankments, ASCE Journal of Soil Mechanics and Foundation, v. 92, no. SM2, p. 125-146.Hart, E.W., and Bryant, W.A., 1997 (revised), Fault-rupture hazard zones in California: California Department of Conservation, Division of Mines and Geology (now California geological Survey) Special Publication 42, 38 p.
- Hart, E.W., and Bryant, W.A., 1997 (revised), Fault-rupture hazard zones in California: California Department of Conservation, Division of Mines and Geology (now California Geological Survey) Special Publication 42, 38p.
- Hynes, M.E. and Franklin, A.G., 1984, "Rationalizing the Seismic Coefficient Method," Miscellaneous Paper GL-84-13, U.S. Army Waterways Experiment Stations, Vicksburg, MS, July, 21 p.
- Idriss, I. M. 1985 "Evaluating Seismic Risk in Engineering Practice." In *Proceedings of the 11th International Conference on Soil Mechanics and Foundation Engineering*, Vol. 1, p. 155.

- Ishihara, Kenji. 1985. "Stability of Natural Deposits During Earthquakes." In *Proceedings of the 11th International Conference on Soil Mechanics and Foundation Engineering*, San Francisco, Vol. 1, pp. 321-376.
- Kelson, K.I., Kang, K.-H., Page, W.D., Lee, C.-T., and Cluff, L.S., 2001, Representative styles of deformation along the Chelungpu fault from the 1999 Chi-Chi (Taiwan) Earthquake: Geomorphic characteristics and responses of man-made structures: *Bulletin of the Seismological Society of America*, v. 91, no. 5, p. 930-952.
- Kramer, S. L. 1996. *Geotechnical Earthquake Engineering*. New Jersey: Prentice Hall.
- Lam, I., and G. R. Martin. 1986. *Seismic Design of Highway Bridge Foundations—Design Procedures and Guidelines*, Report FHWA/RD-86/102. Washington, D.C.: FHWA.
- Lam, I., Bertero, V., 1990 "Aseismic Design of Pile Foundations for Port Facilities", *Proceedings of the POLA Seismic Workshop on Seismic Engineering*, March 21-23, San Pedro, California, Port of Los Angeles.
- Lysmer, J., M. Tabatabai-Rassi, F. Jajirian, S. Vahdani, and F. Ostadan. 1981. *SASSI — A System for Analysis of Soil-Structure Interaction*, Report UCB/GT/81-02. Berkeley: University of California Department of Engineering.
- Lysmer, J., T. Udka, C. P. Tsai, and H. B. Seed. 1975. *FLUSH: A Computer Program for Approximate 2-D Analysis of Soil-Structure Interaction Problems*, Report EERC 75-30. Berkeley: University of California, Earthquake Engineering Research Center.
- Makdisi, F. T., and H. B. Seed. 1978. "Simplified Procedure for Estimating Dam and Embankment Earthquake-Induced Deformations." *Journal of Geotechnical Engineering ASCE* 104(GT7):849-867.
- Margason, E., and M. Holloway. 1977. "Pile Bending During Earthquakes." In *Proceedings of the 6th World Conference on Earthquake Engineering, New Delhi*.
- Martin, G.R., and Qiu, P., 1994, "Effects of Liquefaction on Vulnerability Assessment," NCEER Highway Project on Seismic Vulnerability of New and Existing Highway Construction, One Year Research Tasks – Technical Research Papers, 1994.
- Martin, G.R., and Lew, M. 1999, "Recommended Procedures for Implementation of DMG Special Technical Publication 117, Guidelines for Analyzing and Mitigating Liquefaction in California," Southern California Earthquake Center, University of Southern California, March, 63 p.
- Martin, G.R., and Lam, I.P., 2000, "Earthquake Resistant Design of Foundations: Retrofit of Existing Foundations," *Proceedings, GeoEng 2000, International Conference on Geological and Geotechnical Engineering*, Melbourne, Australia, November.
- Monobe, N., and H. Matsuo. 1929. "On the Determination of Earth Pressures During Earthquakes." In *Proceedings, World Engineering Congress*.
- Mylonakis, G., 2001, Seismic pile bending at soil-layer interfaces, *Soils and Foundations*, 41 (4), 47-58.
- Nadim, F. 1980. "Tilting and Sliding of Gravity Retaining Walls," MS thesis, Department of Civil Engineering, Massachusetts Institute of Technology, Cambridge.
- Nadim, F., and R. V. Whitman. 1984. "Coupled Sliding and Tilting of Gravity Retaining Walls During Earthquakes." In *Proceedings of the Eighth World Conference on Earthquake Engineering*, pp. 477-484. National Research Council, Committee on Earthquake Engineering. 1985. *Liquefaction of Soils During Earthquakes*. Washington, D.C.: National Academy Press.
- National Center for Earthquake Engineering Research (NCEER). 1997. *Proceedings of the NCEER Workshop on Evaluation of Liquefaction Resistance of Soils*, Technical Report NCEER-97-0022, 276 p.

- National Research Council. 1985. *Liquefaction of Soils During Earthquakes*, National Academy Press, 240p.
- Newmark, N.M. 1965. "Effects of earthquakes on dams and embankments," *Geotechnique*, London, England v.5, no.2.
- Norris, G. M. 1994. "Seismic Bridge Pile Foundation Behavior," in *Proceedings, International Conference on Design and Construction of Deep Foundations*, FHWA, Vol. 1.
- Okabe, S. 1926. "General Theory of Earth Pressure," *Journal of the Japan Society of Civil Engineers* 12,1.
- Ostadan, F., and W. H. White. 1998. *Lateral Seismic Soil Pressure—An Updated Approach*. In *Preproceedings of UJNR Workshop on Soil-Structures Interaction*, U.S. Geological Survey, Menlo Park, California.
- Park, R. and Hoat Joen, P., 1990. "Simulated Seismic Load Tests on Prestressed Concrete Piles and Pile-Pile Cap Connections", *PCI Journal*, November-December.
- Prakash, S. 1981. *Soil Dynamics*. New York: McGraw-Hill Book Co.
- Prakash, S., Y. Wu, and E. A. Rafnsson. 1995. *Displacement Based Aseismic Design Charts for Rigid Walls*. Rolla, Missouri: Shamsheer Prakash Foundation.
- Precast Concrete Institute, 1993. "Recommended Practice for Design, Manufacture and Installation of Prestressed Concrete Piling", *PCI Committee on Pre-stressed Concrete Piling*, *PCI Journal*, March-April.
- Richards, R. J., and D. Elms. 1979. "Seismic Behavior of Gravity Retaining Walls." *Journal of the Geotechnical Engineering Divisions, ASCE* 105(GT4): 449-464.
- Richards, R., K. L. Fishman, and R. Devito. 1996. "Threshold Accelerations for Rotation or Sliding of Bridge Abutments," *Journal of Geotechnical Engineering, ASCE* 105, GT4, 449-464.
- Robertson, P.K., and Wride, C.E. 1998. "Evaluation of cyclic liquefaction potential using the cone penetration test," *Canadian Geotechnical Journal*, Ottawa, 35(3), 442-459.
- Rollins, Kyle M., Peterson, K.T., Weaver, T.J., Sparks, Andrew E., 1999. *Static and dynamic lateral load behavior on a full-scale pile group in clay*, Brigham Young University, Provo, Utah and the Utah Department of Transportation, Salt Lake City, Utah, 23 June.
- Seed, H. B., and I. M. Idriss. 1971. "Simplified Procedure for Evaluating Soil Liquefaction Potential." *Journal of the ASCE Soil Mechanics and Foundations Division* 97(SM9):1249-1273.
- Seed, H. B., K. Tokimatsu, L. F. Harder, and R. M. Chung. 1985. *The Influence of SPT Procedures in Soil Liquefaction Resistance Evaluations*, Report UBC/EERC-84/15. Berkeley, California: Earthquake Engineering Research Center.
- Seed, H. B., I. M. Idriss, and I. Arango. 1983. "Evaluation of Liquefaction Potential Using Field Performance Data." *ASCE Journal of Geotechnical Engineering* 109(3):458-482.
- Seed, H. B., and I. M. Idriss. 1982. *Ground Motions and Soil Liquefaction During Earthquakes*, Vol. 5 of *Engineering Monographs on Earthquake Criteria, Structural Design, and Strong Motion Records*. El Cerrito, California: Earthquake Engineering Research Institute.
- Seed, R. B., and L. F. Harder. 1990. "SPT-Based Analysis of Cyclic Pore Pressure Generation and Undrained Residual Strength." In *Proceedings of the H. Bolton Seed Memorial Symposium*, Vol. 2, pp. 351-376.
- Seed, H. B., and R. V. Whitman. 1970. "Design of Earth Retaining Structures for Dynamic Loads," in *Proceedings, ASCE Specialty Conference on Lateral Stresses in the Ground and Design of Earth-Retaining Structures*, pp. 103-147. Ithaca, New York: Cornell University.
- Shepard, D. A. 1983. "Seismic Design of Concrete Piling." *PCI Journal* (March/April).

- Siddarthan, R., S. Ara, and G. Norris. 1992. "Simple Rigid Plastic Model for Seismic Tilting of Rigid Walls," *Journal of Structural Engineering*, ASCE, 469-487.
- Slemmons, D.B., and dePolo, C.M., 1986, Evaluation of active faulting and associated hazards, in *Studies in Geophysics—Active Tectonics*: National Academy Press, Washington, D.C., p. 45-62.
- Soydemir, C., and M. Celebi. 1992. "Seismic Design of Buildings with Multi-Level Basements," in *Proceedings*, Tenth World Conference on Earthquake Engineering, Madrid Spain, Vol. 6, pp. 1731-1734.
- Stark, T.D., and Mesri, G., 1992. "Undrained Shear Strength of Liquefied Sands for Stability Analysis", *Journal of Geotechnical Engineering*, American Society of Civil Engineers, v. 118, no. 11, p. 1727-1747.
- Steedman, R. S., and X. Zeng. 1996. "Rotation of Large Gravity Retaining Walls on Rigid Foundations Under Seismic Loading." In *Analysis and Design of Retaining Walls Against Earthquakes*, ASCE Geotechnical Special Publication 60, edited by S. Prakash, pp. 38-56. New York: ASCE.
- Stewart, J.P., Blake, T.M., and Hollingsworth, R.A., 2003, A screen analysis procedure for seismic slope stability: *Earthquake Spectra*, 19 (3).
- Swan, F.H., Stepp, J.C., McGuire, R.K., 1991, Assessment of the potential for tectonic fault rupture for high-level nuclear waste repositories: *Quarterly Journal of Engineering Geology*, v. 24, p. 337-346.
- Tokimatsu, K., and H. B. Seed. 1987. "Evaluation of Settlements in Sands Due to Earthquake Shaking." *Journal of Geotechnical Engineering* ASCE 113(8):861-878.
- U.S. Army Corps of Engineers, 1988. *Seismic Design for Buildings*, TI-809-04, Appendix F, Geologic Hazards Evaluations.
- Utah Section of the Association of Engineering Geologists, 1987, Guidelines for evaluating surface fault rupture hazard in Utah: Utah Geological and Mineral Survey Miscellaneous Publication N, 2 p.
- Veletsos, A., and A. H. Younan. 1994a. "Dynamic Soil Pressure on Rigid Vertical Walls," *Earthquake Engineering and Soil Dynamics*, 23:275-301.
- Veletsos, A. and Younan, A. H. 1994b. "Dynamic Modeling and Response of Soil-Wall Systems," *Journal of Geotechnical Engineering*, ASCE, 120:12.
- Wells, D.L., and Coppersmith, K.J., 1994, "New Empirical Relationships Among Magnitude, Rupture Area, and Surface Displacement," *Bulletin of the Seismological Society of America*, Vol, 84, p. 974-1002.
- Whitman, R. V. 1991. "Seismic Design of Earth Retaining Structures," in *Proceedings*, Second International Conference on Recent Advances in Geotechnical Earthquake Engineering and Soil Dynamics, St. Louis, Missouri.
- Whitman, R. V., and S. Liao. 1985. *Seismic Design of Retaining Walls*, Miscellaneous Paper GL-85-1. Vicksburg, Mississippi: Corps of Engineers Waterways Experiment Station.
- Wong, C.P. and Whitman, R.V., 1982. "Seismic Analysis and Improved Seismic Design Procedure for Gravity Retaining Walls," Research Report 82-83, Department of Civil Engineering, Massachusetts Institute of Technology, Cambridge, MA.
- Wood, J. H. 1973. *Earthquake-Induced Soil Pressures on Structures*, Report EERL 73-05. Pasadena: California Institute of Technology.
- Youd, T. L. 1989. "Ground Failure Damage to Buildings During Earthquakes." In *Foundation Engineering—Current Principles and Practices*, Vol. 1, pp. 758-770. New York: American Society of Civil Engineers.

Youd, T.L., and Noble, S.K., 1997, Magnitude scaling factors, *Proc. NCEER Workshop on Evaluation of Liquefaction Resistance of Soils*, National Center for Earthquake Engineering Research, State University of New York at Buffalo, 149-165.

Youd, T.L., Hansen, C.M., and Bartlett, S.F., 2002, Revised multilinear regression equations for prediction of lateral spread displacement, *ASCE Journal of Geotechnical and Geoenvironmental Engineering*, 128:12, p. 1007-1017.

Youd, T.L., Idriss, I.M., Andrus, R.D., Arango, I., Castro, G., Christian, J.T., Dobry, R., Finn, W., D.L. Harder, L.F., Jr., Hynes, M.E., Ishihara, K., Koester, J.P., Liao, S.S.C., Marcuson, W. F., III, Martin, G.R. Mitchell, J.K., Moriwaki, Y., Power, M.S., Robertson, P.K., Seed, R.B., and Stokoe, K.H., II, 2001. Liquefaction resistance of soils: Summary Report from the 1996 NCEER and 1998 NCEER/NSF Workshops on Evaluation of Liquefaction Resistance of Soils, *Journal of Geotechnical Geoenvironmental Engineering*, ASCE, 127 (10), p. 817-833.

Youngs, R.R., Arabasz, W.J., Anderson, R.E., Ramelli, A.R., Ake, J.P., Slemmons, D.B., McCalpin, J.P., Doser, D.I., Fridrich, C.J., Swan III, F.H., Rogers, A.M., Yount, J.C., Anderson, L.W., Smith, K.D., Bruhn, R.L., Kneupfer, P.L.K., Smith, R.B., dePolo, C.M., O'Leary, D.W., Coppersmith, K.J., Pezzopane, S.K., Schwartz, D.P., Whitney, J.W., Olig, S.S., and Toro, G.R., 2003, A methodology for probabilistic fault displacement hazard analysis (PFDHA): *Earthquake Spectra*, v. 19, no. 1, p. 191-219.

Appendix to Chapter 7

GEOTECHNICAL ULTIMATE STRENGTH DESIGN OF FOUNDATIONS AND FOUNDATION LOAD-DEFORMATION MODELING

A7.2 GENERAL DESIGN REQUIREMENTS

A7.2.2. Foundation load capacities. In current geotechnical engineering practice, foundation design is based on allowable stresses, with allowable foundation load capacities, Q_{as} , for dead plus live loads based on limiting static settlements and providing a large factor of safety against exceeding ultimate capacities. In current practice, allowable soil stresses for dead plus live loads are increased by one-third for load combinations that include wind or seismic forces. The one-third increase is overly conservative if the allowable stresses for dead plus live loads are far below ultimate soil capacity.

This appendix provides guidance for the direct use of ultimate foundation load capacity, Q_{us} , for load combinations including seismic effects. It is required that foundations be capable of resisting loads with acceptable deformations considering the short duration of seismic loading, the dynamic properties of the soil, and the ultimate load capacities, Q_{us} , of the foundations under vertical, lateral, and rocking loading.

A7.2.2.1. Determination of ultimate foundation load capacities. For competent soils that are not expected to degrade in strength during seismic loading (e.g., due to partial or total liquefaction of cohesionless soils or strength reduction of sensitive clays), use of static soil strengths is recommended for determining ultimate foundation load capacities, Q_{us} . Use of static strengths is somewhat conservative for such soils because rate-of-loading effects tend to increase soil strengths for transient loading. Such rate effects are neglected because they may not result in significant strength increase for some soil types and are difficult to confidently estimate without special dynamic testing programs. The assessment of the potential for soil liquefaction or other mechanisms for reducing soil strengths is critical, because these effects may reduce soil strengths greatly below static strengths in susceptible soils.

The best-estimated ultimate vertical load capacity of footings, Q_{us} , should be determined using accepted foundation engineering practice. In the absence of moment loading, the ultimate vertical load capacity of a rectangular footing of width B and length L may be written as

$$Q_{us} = q_c BL$$

where q_c = ultimate soil bearing pressure.

For rigid footings subject to moment and vertical load, contact stresses become concentrated at footing edges, particularly as footing uplift occurs. The ultimate moment capacity, M_{us} , of the footing as limited by the soil is dependent upon the ratio of the vertical load stress, q , to the ultimate soil bearing pressure q_c . Assuming that contact stresses are proportional to vertical displacements and remain elastic up to q_c , it can be shown that uplift will occur prior to plastic yielding of the soils when q/q_c is less than 0.5. If q/q_c is greater than 0.5, then the soil at the toe will yield prior to uplift. This is illustrated in Figure CA7.2.2-1. In general the ultimate moment capacity of a rectangular footing may be expressed as:

$$M_{us} = \frac{LP}{2} \left(1 - \frac{q}{q_c} \right)$$

where

$P =$ Vertical Load
 $q = \frac{P}{BL}$
 $B =$ Footing width, and
 $L =$ Footing length in direction of rotation

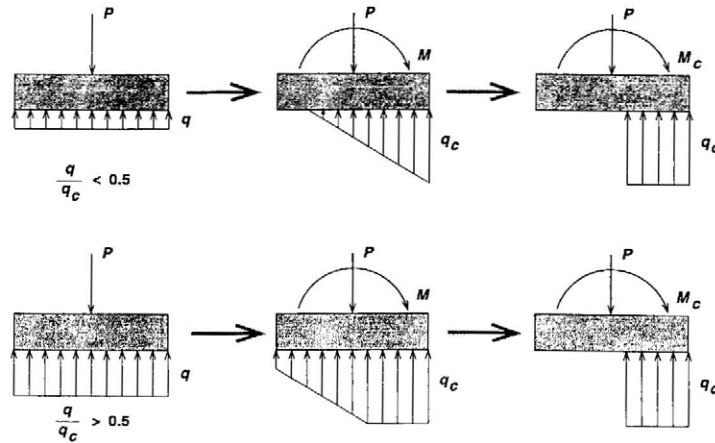

Figure CA7.2.2-1.

The ultimate lateral load capacity of a footing may be assumed equal to the sum of the best-estimated ultimate soil passive resistance against the vertical face of the footing plus the best-estimated ultimate soil friction force on the footing base. The determination of ultimate passive resistance should consider the potential contribution of friction on the face of the footing on the passive resistance.

For piles, the best-estimated ultimate vertical load capacity (for both axial compression and axial tensile loading) should be determined using accepted foundation engineering practice. When evaluating axial tensile load capacity, consideration should be given to the capability of pile cap and splice connections to take tensile loads.

The ultimate moment capacity of a pile group should be determined assuming a rigid pile cap, leading to an initial triangular distribution of axial pile loading from applied overturning moments. However, full axial capacity of piles may be mobilized when computing ultimate moment capacity, in a manner analogous to that described for a footing in Figure CA7.2.2-1. The ultimate lateral capacity of a pile group may be assumed equal to the best-estimated ultimate passive resistance acting against the edge of the pile cap and the additional passive resistance provided by piles.

Resistance factors, ϕ , are provided to factor ultimate foundation load capacities, Q_{us} , to reduced capacities, ϕQ_{us} , used to check foundation acceptance criteria. The values of ϕ recommended in the *Provisions* are higher than those recommended in some codes and specifications for long-term static loading. The development of resistance factors for static loading has been based on detailed reliability studies and on calibrations to give designs and factors of safety comparable to those given by allowable stress design. As indicated in the first paragraph of this section, mobilized strengths for seismic loading conditions are expected to be somewhat higher than the static strengths specified for use in obtaining values of Q_{us} , especially for cohesive soils. In the absence of any detailed reliability studies for seismic loading conditions, Values of ϕ equal to 0.8 and 0.7 were selected for cohesive and cohesionless soils, respectively, where geotechnical site investigations, including laboratory or insitu tests, are conducted,

and values of ϕ equal to 1.0 and 0.9 were selected where full-scale field testing of prototype foundations are conducted. These values are comparable to the values of 0.8 (for soil strengths determined based on a comprehensive site soil investigation including soil sampling and testing) and 0.9 (for soil strengths determined by site loading testing using plate bearing or near full scale foundation element testing) recommended by the SEAOC Seismology Committee Ad Hoc Foundation Committee (2001).

A7.2.2.2 Acceptance criteria. The factored load capacity, ϕQ_{us} , provides the basis for the acceptance criteria, particularly for the linear analysis procedures. The mobilization of ultimate capacity in the nonlinear analysis procedures does not necessarily mean unacceptable performance as structural deformations due to foundation displacements may be tolerable, as discussed by Martin and Lam (2000). For the nonlinear analysis procedures, it is also prudent to evaluate structural behavior utilizing parametric increases in foundation load capacities above Q_{us} by a factor of $1/\phi$, to check potential changes in structural ductility demands.

A7.2.3 Foundation load-deformation modeling. Analysis methods described in Sec. 5.3 (response spectrum procedure) and Sec. 5.4 (linear response history procedure), permit the use of realistic assumptions for foundation stiffness, as opposed to the assumption of a fixed base. In addition, the nonlinear response history procedure (Sec. 5.5) and the nonlinear static procedure (Appendix to Chapter 5) permit the use of realistic assumptions for the stiffness and load-carrying characteristics of the foundations. Guidance for flexible foundation (non-fixed base) modeling for the above analysis procedures are described herein.

Foundation load-deformation behavior characterized by stiffness and load capacity may significantly influence the seismic performance of a structure, with respect to both load demands and distribution among structural elements (ATC 1996, NEHRP 1997a, 1997b). This is illustrated schematically in Figure CA 7.2.3-1. While it is recognized that the load-deformation behavior of foundations is nonlinear, an equivalent elasto-plastic representation of load-deformation behavior is often assumed, as illustrated in Figure CA 7.2.3-2. To allow for variability and uncertainty in the selection of soil parameters and analysis methods used to determine stiffness and capacity, a range of parameters for foundation modeling should be used to permit sensitivity evaluations.

Foundation stiffness and strength affect various structural components differently.

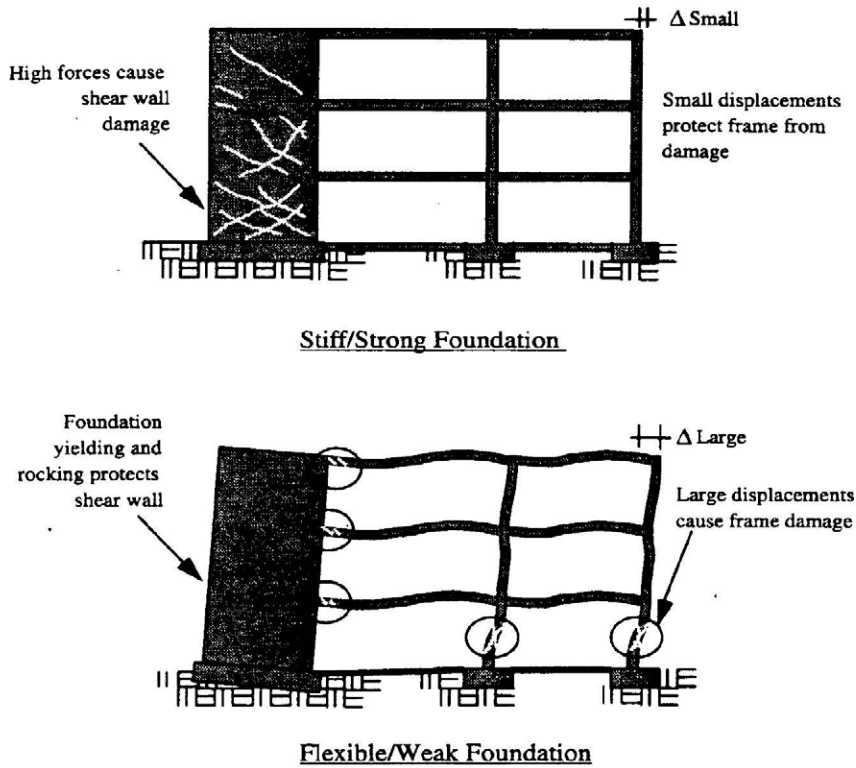

***Stiff/strong is not always favorable;
nor is flexible/weak always conservative.***

Figure CA7.2.3-1.

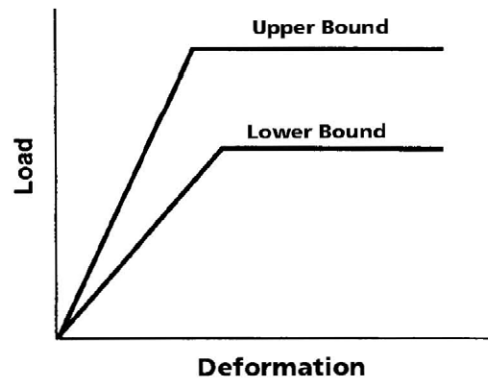

Figure CA7.2.3-2.

Consider the spread footing shown in Figure CA 7.2.3-3 with an applied vertical load (P), lateral load (H), and moment (M). The soil characteristics might be modeled as two translational springs and a rotational spring, each characterized by a linear elastic-stiffness and a plastic capacity. The use of a Winkler spring model acting in conjunction with the foundation to eliminate the rotational spring may also be used, as shown in Figure CA7.2.3-4. The Winkler model can capture more accurately progressive mobilization of plastic capacity during rocking behavior. Note the lateral action is normally uncoupled from the vertical and rotational action. Many foundation systems are relatively stiff and strong in the horizontal direction, due to passive resistance against the face of footings or basement walls, and friction beneath footings and floor slabs. Comparisons of horizontal stiffness of the foundation and the structure can provide guidance on the need to include horizontal foundation stiffness in demand or capacity analyses. In general, foundation rocking has the most influence on structural response. Slender shear wall structures founded on strip footings, in particular, are most sensitive to the effects of foundation rocking.

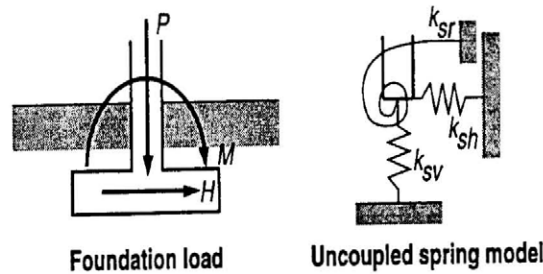

Figure CA7.2.3-3.

Assuming a shallow footing foundation may be represented by an embedded rigid plate in an elastic half-space, classical elastic solutions may be used to compute the uncoupled elastic stiffness parameters. Representative solutions are described in *Commentary* to Sec. 5.6. Solutions developed by Gazetas (1991) are also often used, as described in ATC (1996). Dynamic soil properties (i.e. properties consistent with seismic wave velocities and associated moduli of the soils as opposed to static soil moduli) should be used in dynamic soil solutions. The effects of nonlinearity on dynamic soil properties should be incorporated using the reduction factors in Sec. 5.6.2.1.1 or based on a site-specific study.

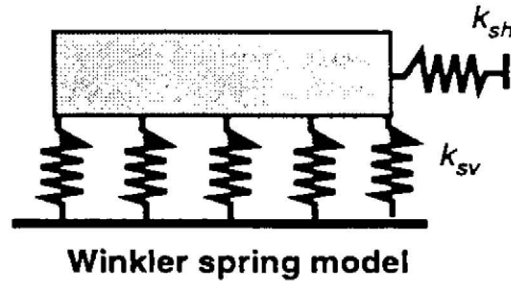

Figure CA 7.2.3-4.

In the case of pile groups, the uncoupled spring model shown in Figure CA 7.2.3-3 may also be used, where the footing represents the pile cap. In the case of the vertical and rotational springs, it can be assumed that the contribution of the pile cap is relatively small compared to the contribution of the piles. In general, mobilization of passive pressures by either the pile caps or basement walls will control lateral spring stiffness. Hence, estimates of lateral spring stiffness can be computed using elastic solutions as for footings. In instances where piles may contribute significantly to lateral stiffness (i.e., very soft soils, battered piles), solutions using beam-column pile models are recommended.

Axial pile group stiffness spring values, k_{sv} , are generally in the range given by:

$$k_{sv} = \sum_{n=1}^N \frac{0.5AE}{L} \quad \text{to} \quad \sum_{n=1}^N \frac{2AE}{L}$$

where

A = Cross-sectional area of a pile,

E = Modulus of elasticity of piles,

L = Length of piles, and

N = Number of piles in group.

Values of axial stiffness depend on complex nonlinear interaction of the pile and soil (NEHRP, 1997b). For simplicity, best estimate values of AE/L and $1.5 AE/L$ are recommended for piles where axial capacity is primarily controlled by end bearing and side friction, respectively.

The rocking spring stiffness values, k_{sr} , about each horizontal pile cap axis may be computed by assuming each axial pile spring acts as a discrete Winkler spring. The rotational spring constant (moment per unit rotation) is then given by:

$$k_{sr} = \sum_{n=1}^N k_{vn} S_n^2$$

where

k_{vn} = Axial stiffness of the nth pile, and

S_n = Distance between nth pile and axis of rotation.

The effects of group action and the influence of pile batter are not accounted for in the above equations. These effects should be evaluated if judged significant.

Design Examples. In order to study and illustrate the effects of the change from allowable stress to ultimate strength design of foundations a series of examples were generated. The examples compared the size of foundations resulting from ultimate strength designs (USD) according the new procedures with those that would be obtained from conventional allowable stress designs (ASD).

The examples were based upon a single six-story reinforced concrete building with shear walls and gravity frame (see Figure 7.2.3-5). One set of examples was for a shallow spread footing design beneath a shear wall. The other set applied to deep CIDH piers placed beneath the same wall. For each set of examples, individual designs reflected a range of soil strengths and ASD factors of safety. The vertical loads were not changed, but two levels of seismic overturning demand were imposed.



Example spread footing

Note: For a detailed description see *ATC 40 vol.2*

Example
CIDH piers

Figure 7.2.3-5 Example building.

While is not possible to generalize the results of these examples to apply universally, they are representative of the effects of the change to USD for a realistic case study. For the spread footing foundation the area of the footing for USD compared to that for ASD is controlled by the factor of safety applied to the soil strength for vertical loads. This reduction ranged from 0% to 20 percent for a low FOS (2) up to 25 percent to 40 percent for a high FOS (4). This is not surprising; where ASD uses a high factor of safety and is thus most conservative, USD results in a smaller footing size. However, the footing size cannot be smaller than that required for allowable stresses for static design under vertical dead plus live loads. For the pier example, the required length for USD was actually about 50 percent greater than for ASD for a low FOS (1.5) and up to 40 percent less for a high FOS (4).

REFERENCES

ATC, 1996, *ATC 40, Seismic Evaluation and Retrofit of Concrete Buildings*, 2 Volumes, The Applied Technology Council, Redwood City, CA.

Gazetas, G. (1991), "Foundation Vibrations," *Foundation Engineering Handbook*, 2nd Edition, Van Nostrand Reinhold, Edited by Hsai-Yang Fang.

Martin, G.R. and Lam, I.P., 2000, "Earthquake Resistant Design of Foundations: Retrofit of Existing Foundations," *Proceedings*, GeoEng 2000, International Conference on Geological and Geotechnical Engineering, Melbourne, Australia, November.

NEHRP, 1997a, and 1997b, *National Earthquake Hazard Reduction Program Guidelines and Commentary for the Seismic Rehabilitation of Buildings*, developed for the Building Seismic Safety Council for the Federal Emergency Management Agency, (Publications FEMA 273 and 274).

SEAOC Seismology Committee, Ad Hoc Foundations Committee, 2001, "USD/LRFD/Limit State Approach to Foundation Design", *Proceedings* of the 70th Annual SEAOC Convention, San Diego, California.

Chapter 8 Commentary

STEEL STRUCTURE DESIGN REQUIREMENTS

8.1 GENERAL

8.1.2 References. The reference documents presented in this section are the current specifications for the design of steel members, systems, and components in buildings as approved by the American Institute of Steel Construction (AISC), the American Iron and Steel Institute (AISI), the American Society of Civil Engineers (ASCE) and the Steel Joist Institute (SJI).

Revise the AISC Seismic Commentary Sec. C9.3 as follows: At the end of the second paragraph add the following: “This provision requires that the panel zone be proportioned using the method used to proportion the panel zone thickness of successfully tested connections. This should not be construed to mean that the thickness is required to be the same as the tested connection, only that the same method must be used to proportion it. For example, if the test were performed on a one-sided connection and the same beam and column sizes were used in a two-sided connection, the panel zone would be twice as thick as that of the tested connection.”

8.2 GENERAL DESIGN REQUIREMENTS

8.2.1 Seismic Design Categories B and C. Structures assigned to Seismic Design Categories B and C do not require the same level of ductility capacity to provide the required performance as those assigned to the higher categories. For this reason, such structures are permitted to be designed using the requirements of any of the listed references, provided that the lower R value specified in Table 4.3-1 is used. Should the registered design professional choose to use the higher R values in the table, the detailing requirements for the higher Seismic Design Categories must be used.

8.2.2 Seismic Design Categories D, E, and F. Structures assigned to these categories must be designed in anticipation of significant ductility demands that may be placed on the structures during their useful life. Therefore, structures in these categories are required to be designed to meet special detailing requirements as referenced in this section.

8.4 COLD-FORMED STEEL

The allowable stress and allowable load levels in AISI are incompatible with the force levels calculated in accordance with these *Provisions*. It is therefore necessary to modify the provisions of AISI for use with the *Provisions*. ANSI/ASCE 8 and SJI are both based on LRFD and thus are consistent with the force levels in the *Provisions*. As such, only minor modifications are needed to correlate those load factors for seismic loads to be consistent with the *Provisions*. The modifications of all of the reference documents affect only designs involving seismic loads.

8.4.2 Light-frame walls. The provisions of this section apply to buildings framed with cold-formed steel studs and joists. Lateral resistance is typically provided by diagonal bracing (braced frames) or wall sheathing material. This section is only required for use in Seismic Design Categories D, E, and F. The required strength of connections is intended to assure that inelastic behavior will occur in the connected members prior to connection failure. Since pull-out of screws is a sudden or brittle type of failure, designs using pull-out to resist seismic loads are not permitted. Where diagonal members are used to resist lateral forces, the resulting uplift forces must be resolved into the foundation or other frame members without relying on the bending resistance of the track web. This often is accomplished by directly attaching the end stud(s) to the foundation, frame, or other anchorage device.

Table 8.4-1 presents nominal shear values for plywood and oriented strand board attached to steel stud wall assemblies. Design values are determined by multiplying the nominal values by a phi (ϕ) factor as presented in Sec. 8.4.2.5. These nominal values are based upon tests performed at Santa Clara University (Serrette, 1996). The test program included both cyclic and static tests; however, the values presented in Table 8.4-1 are based upon the cyclic tests as they are intended for use in seismic resistance. In low seismic areas where wind loads dominate, nominal values have been recommended for wind resistance by AISI based upon monotonic tests (Serrette, 1996). The cyclic tests were performed using the assemblies that static testing showed to be the most critical. The cyclically tested assemblies consisted of 3.5 by 1.625 in. C studs fabricated with ASTM A446 Grade A (33 ksi) material with a minimum base metal thickness of 0.033 in. Since the tests were conducted, ASTM A446 Grade A has been redesignated ASTM A653 SQ Grade 33. The test panels were 4 ft wide and 8 ft high, the sheathing material was applied vertically to only a single side of the studs, and there was no sheathing or bracing applied to the other side.

The cyclic tests were performed using a sequential phase displacement protocol under development at the time of the test by an ad hoc Committee of the Structural Engineers Association of Southern California. Nominal values were conservatively established by taking the lowest load in the last set of stable hysteretic loops. It is expected that subsequent testing of steel stud shear wall assemblies will reduce or modify some of the restrictive limits currently proposed for the use of the system such as the nominal maximum thickness of the studs of 0.043 in., the maximum aspect ratio of 2:1, and the ability to use sheathing on both sides of the wall.

8.4.4 Steel deck diaphragms. Since the design values for steel deck are based on allowable loads, it is necessary to present a method of deriving design strengths. Two ϕ values are presented: 0.60 for steel deck that is mechanically attached and 0.50 for welded steel deck. These factors are consistent with current proposals being circulated for inclusion in updates of ANSI/ASCE 8.

8.5 STEEL CABLES

The allowable stress levels of steel cable structures specified in ASCE 19 are modified for seismic load effects.

8.6 RECOMMENDED PROVISIONS FOR BUCKLING-RESTRAINED BRACED FRAMES

8.6.3 Commentary on Buckling-Restrained braced Frames (BRBF)

8.6.3.1. Scope. Buckling-restrained braced frames are a special class of concentrically braced frames. Just as in Special Concentrically Braced Frames (SCBF), the centerlines of BRBF members that meet at a joint intersect at a point to form a complete vertical truss system that resists lateral forces. BRBF have more ductility and energy absorption than SCBFs because overall brace buckling, and its associated strength degradation, is precluded at forces and deformations corresponding to the design story drift. See AISC Sections 13 and 14 for the effects of buckling in SCBF. AISC Seismic Figure C13.1 shows possible BRBF bracing configurations; note that neither x-bracing nor k-bracing is an option for BRBF.

BRBF are characterized by the ability of bracing elements to yield inelastically in compression as well as in tension. In BRBF the bracing elements dissipate energy through stable tension-compression yield cycles (Clark et. al, 1999). Figure C8.6.3.2 shows the characteristic hysteretic behavior for this type of brace as compared to that of a buckling brace. This behavior is achieved through limiting buckling of the steel core within the bracing elements. Axial stress is de-coupled from flexural buckling resistance; axial load is confined to the steel core while the buckling restraining mechanism, typically a casing, resists overall brace buckling and restrains high-mode steel core buckling (rippling).

Buckling-restrained braced frames are composed of columns, beams, and bracing elements, all of which are subjected primarily to axial forces. Braces of BRBF are composed of a steel core and a

buckling-restraining system encasing the steel core. Figure C8.6.3.1 shows a schematic of BRBF bracing element (adapted from Tremblay et al., 1999). More examples of BRBF bracing elements are found in Watanabe et al., 1988; Wada et. al., 1994; and Clark et al., 1999. The steel core within the bracing element is intended to be the primary source of energy dissipation. During a moderate to severe earthquake the steel core is expected to undergo significant inelastic deformations.

BRBF can provide elastic stiffness that is comparable to that of EBF or SCBF. Full-scale laboratory tests indicate that properly designed and detailed bracing elements of BRBF exhibit symmetrical and stable hysteretic behavior under tensile and compressive forces through significant inelastic deformations (Watanabe et. al, 1988; Wada et. al, 1998; Clark et. al, 1999; Tremblay et. al, 1999). The ductility and energy dissipation capability of BRBF is expected to be comparable to that of SMF and greater than that of SCBF. This high ductility is attained by limiting buckling of the steel core.

The axial yield strength of the core, $P_{y_{sc}}$, can be defined without dependence on other variables. This ability to control $P_{y_{sc}}$ significantly reduces the adverse effects of relying on nominal yield strength values. Careful proportioning of braces throughout the building height can result in specification of required $P_{y_{sc}}$ values that meet all of the strength and drift requirements of the applicable building code.

These provisions are based on the use of brace designs qualified by testing. They are intended to ensure that braces are used only within their proven range of deformation capacity, and that yield and failure modes other than stable brace yielding are precluded at the maximum inelastic drifts corresponding to the design earthquake. For analyses performed using linear methods, the maximum inelastic drifts for this system are defined as those corresponding to 150 percent of the design story drift. For nonlinear time-history analyses, the maximum inelastic drifts can be taken directly from the analyses results. This approach is consistent with the linear analysis equations for design story drift in the *1997 Uniform Building Code* and the *2003 NEHRP Recommended Provisions*. It is also noted that the consequences of loss of connection stability due to the actual seismic displacements exceeding the calculated values may be severe; braces are therefore required to have a larger deformation capacity than directly indicated by linear static analysis.

These provisions have been written assuming that future editions of *NEHRP Recommended Provisions* and of national codes will define system coefficients and limits for BRBFs. The assumed values for the response modification coefficient, system over strength factor, are deflection amplification factor are 8, 2, and 5.5 respectively. Height limits matching those for eccentrically braced frames are also expected.

The design engineer utilizing these provisions is strongly encouraged to consider the effects of configuration and proportioning of braces on the potential formation of building yield mechanisms. It is also recommended that engineers refer to the following documents to gain further understanding of this system: Watanabe et al., 1988, Reina et al., 1997, Clark et al., 1999, Tremblay et al., 1999, and Kalyanaraman et al., 1998.

During the planning stages of either a subassembly or uniaxial brace test, certain conditions may exist that cause the test specimen to deviate from the parameters established in the testing appendix. These conditions may include:

- Availability of beam, column, and brace sizes that reasonably match those to be used in the actual building frame
- Test set-up limitations in the laboratory
- Actuator and reaction-block capacity of the laboratory
- Transportation and field-erection constraints
- Actuator to subassembly connection conditions that require reinforcement of test

specimen elements not reinforced in the actual building frame

In certain cases, both building official and qualified peer reviewer may deem such deviations acceptable. The cases in which such deviations are acceptable are project-specific by nature and, therefore, do not lend themselves to further description in this *Commentary*. For these specific cases, it is recommended that the engineer of record demonstrate that the following objectives are met:

- Reasonable relationship of scale
- Similar design methodology
- Adequate system strength
- Stable buckling-restraint of the steel core
- Adequate rotation capacity
- Adequate cumulative strain capacity

8.6.3.2. Bracing Members

8.6.3.2.1 Composition

8.6.3.2.1.1 Steel Core. The steel core is composed of a yielding segment and steel core projections; it may also contain transition segments between the projections and yielding segment. The area of the yielding segment of the steel core is expected to be sized so that its yield strength is fairly close to the demand calculated from the applicable building code base shear. Designing braces close to the predicted required strengths will help ensure distribution of yielding over multiple stories in the building. Conversely, over-designing some braces more than others (e.g., by using the same size brace on all floors), may result in an undesirable concentration of inelastic deformations in only a few stories. The length and area of the yielding segment, in conjunction with the lengths and areas of the non-yielding segments, determine the stiffness of the brace. The yielding segment length and brace inclination also determines the strain demand corresponding to the design story drift.

In typical brace designs, a projection of the steel core beyond its casing is necessary in order to accomplish a connection to the frame. Buckling of this unrestrained zone is an undesirable yield mode and must therefore be precluded.

In typical practice, the designer specifies the core plate dimensions as well as the steel material and grade. The steel stress-strain characteristics may vary significantly within the range permitted by the steel specification, potentially resulting in significant brace overstrength. This overstrength must be addressed in the design of connections as well as of frame beams and columns.

In order to reduce this source of overstrength, the designer may choose to specify a brace capacity corresponding to a defined displacement (typically 150 percent of the design story drift) in the design documents. In addition, the designer may specify a limited range of acceptable yield stress in order to more strictly define the permissible range of core plate area. The brace supplier may then select the final core plate dimensions to meet the capacity requirement using the mill certificate or the results of a coupon test. The designer should be aware that this approach may result in a deviation from the calculated brace axial stiffness. The maximum magnitude of the deviation is dependant on the range of acceptable material yield stress. Designers following this approach should consider the possible range of stiffness in the building analysis in order to adequately address both the building period and expected drift.

8.6.3.2.1.2 Buckling-Restraining System. This term describes those elements providing brace stability against overall buckling. This includes the casing as well as elements connecting the core. The adequacy of the buckling-restraining system must be demonstrated by testing.

8.6.3.2.2 Testing. Testing of braces is considered necessary for this system. The applicability of

tests to the designed brace is defined in Sec. 8.6.3.7. Sec. 9.2a, which describes in general terms the applicability of tests to designs, applies to BRBF.

BRBF designs require reference to successful tests of a similarly-sized test specimen and of a brace subassembly that includes rotational demands. The former is a uniaxial test intended to demonstrate adequate brace hysteretic behavior. The latter is intended to verify the general brace design concept and demonstrate that the rotations associated with frame deformations do not cause failure of the steel core projection, binding of the steel core to the casing, or otherwise compromise the brace hysteretic behavior. A single test may qualify as both a subassembly and a brace test subject to the requirements of Sec. 8.6.3.7; for certain frame-type subassembly tests, obtaining brace axial forces may prove difficult and separate brace tests may be necessary. A sample subassembly test is shown in Figure C8.6.3.5 (from Tremblay, 1999).

Tests cited serve another function in the design of BRBF: the maximum forces that the brace can deliver to the system are determined from test results. Calculation of these maximum forces is necessary for connection design and for the design of beams in V- and inverted-V configurations (see Sec. 8.6.3.4.1.3). In order to permit a realistic design of these beams, two separate calculations are made. The compression-strength adjustment factor, β , accounts for the compression overstrength (with respect to tension strength) noted in buckling-restrained braces in recent testing (SIE, 1999). The tension strength adjustment factor, ω , accounts for material overstrength (R_y) and strain hardening. Figure C-8.3.6.3 shows a diagrammatic bilinear force-displacement relationship in which the compression strength adjustment factor β and the tension-strength adjustment factor ω are related to brace forces and nominal material yield strength. These quantities are defined as:

$$\beta = \frac{\beta \omega F_y A}{\omega F_y A} = \frac{P_{\max}}{T_{\max}}$$

$$\omega = \frac{\omega F_y A}{F_y A} = \frac{T_{\max}}{F_y A}$$

where P_{\max} is the maximum compression force and T_{\max} is the maximum tension force within deformations corresponding to 150 percent of the Design Story Drift (these deformations are defined as $1.5D_{bm}$ in the Appendix on testing). The acceptance criteria for testing require that values of β and ω be greater than or equal to 1.0 for buckling-restrained braces.

8.6.3.2.3 Quality Assurance. The design provisions for BRBF's are predicated on reliable brace performance. In order to assure this performance, a quality assurance plan is required. These measures are in addition to those covered in the code of standard practice and Sec. 18. Examples of measures that may provide quality assurance are:

- Special inspection of brace fabrication.
- Inspection may include confirmation of fabrication and alignment tolerances, as well as NDT methods for evaluation of the final product.
- Brace manufacturer's participation in a recognized quality certification program.
- Certification should include documentation that the manufacturer's quality assurance plan is in compliance with the requirements of the BRBF Provisions, the Seismic Provisions for Structural Steel Buildings, and the Code of Standard Practice. The manufacturing and quality control procedures should be equal to, or better, than those used to manufacture brace test specimens.

8.6.3.3 Bracing Connections. Bracing connections must not yield at force levels corresponding to the yielding of the steel core; they are therefore designed for the maximum force that can be expected from the brace. In the actual building frame, the use of slip-critical bolts designed at factored loads is encouraged (but not required) to greatly reduce the contribution of bolt slip to the total inelastic deformation in the brace. Because of the way bolt capacities are calibrated, the engineer should recognize that the bolts are going to slip at load demands 30 percent lower than published factored capacities. This slippage is not considered to be detrimental to behavior of the BRBF system and is consistent with the design approach found elsewhere in Sec. 7.2 of AISC Seismic. See also commentary on Sec. C7.2 of AISC Seismic. Bolt holes may be drilled or punched subject to the requirements of LRFD Specification Sec. M2.5.

8.6.3.4 Special Requirements Related to Bracing Configuration

8.6.3.4.1. In SCBF, V-bracing has been characterized by a change in deformation mode after one of the braces buckles. This is due to the negative post-buckling stiffness, as well as the difference between tension and compression capacity, of traditional braces. Since buckling-restrained braces do not exhibit the negative secant stiffness associated with post-buckling deformation, and have only a small difference between tension and compression capacity, the practical requirements of the design provisions for this configuration are relatively minor. Figure C8.6.3.4 shows the deformation mode that develops after one brace has yielded but before the yielding of the opposite brace completes the mechanism. This mode involves flexure of the beam and elastic axial deformation of the un-yielded brace; it also involves inelastic deformation of the yielded brace that is much greater than the elastic deformation of the opposing brace. The drift range that corresponds to this deformation mode depends on the flexural stiffness of the beam. Therefore, where V-braced frames are used, it is required that a beam be provided that has sufficient stiffness, as well as strength, to permit the yielding of both braces within a reasonable story drift considering the difference in tension and compression capacities determined by testing.

The beam is expected to undergo this deflection, which is permanent, during moderate seismic events; a limit is therefore applied to this deflection. Additionally, the required brace deformation capacity must include the additional deformation due to beam deflection under this load. Since other requirements such as the brace testing protocol (Sec. 8.6.3.7.6.3) and the stability of connections (Sec. 8.6.3.3.3) depend on this deformation, engineers will find significant incentive to avoid flexible beams in this configuration. Where the special configurations shown in Figure C13.3 of AISC Seismic are used, the requirements of this section are not relevant.

8.6.3.5 Columns. Columns in BRBF are required to have compact sections because some inelastic rotation demands are possible. Columns are also required to be designed considering the maximum force that the adjoining braces are expected to develop.

8.6.3.6 Beams. Like columns, beams in BRBF are required to have compact sections because some inelastic rotation demands are possible. Likewise, they are also required to be designed considering the maximum force that the adjoining braces are expected to develop.

8.6.3.7.1 Scope and Purpose. Development of the testing requirements in these provisions was motivated by the relatively small amount of test data on this system available to structural engineers. In addition, no data from the response of BRBFs to severe ground motion is available. Therefore, the seismic performance of these systems is relatively unknown compared to more conventional steel-framed structures.

The behavior of a buckling restrained brace frame differs markedly from conventional braced frames and other structural steel seismic-force-resisting systems. Various factors affecting brace performance under earthquake loading are not well understood and the requirement for testing is intended to provide assurance that the braces will perform as required, and also to enhance the overall state of knowledge of these systems.

It is recognized that testing of brace specimens and subassemblages can be costly and time-consuming. Consequently, this Chapter has been written with the simplest testing requirements possible, while still providing reasonable assurance that prototype BRBFs based on brace specimens and subassemblages tested in accordance with these provisions will perform satisfactorily in an actual earthquake.

It is not intended that these provisions drive project-specific tests on a routine basis for building construction projects. In most cases, tests reported in the literature, or supplied by the brace manufacturer, can be used to demonstrate that a brace and subassemblage configuration satisfies the strength and inelastic rotation requirements of these provisions. Such tests, however, should satisfy the requirements of this Chapter.

The provisions have been written allowing submission of data on previously tested, based on similarity conditions. As the body of test data for each brace type grows, the need for additional testing is expected to diminish. The provisions allow for manufacturer-designed braces, through the use of the design methodology.

Most testing programs developed for primarily axial-load-carrying components focus largely on uniaxial testing. However, these provisions are intended to direct the primary focus of the program toward testing of a subassemblage that imposes combined axial and rotational deformations on the brace specimen. This reflects the view that the ability of the brace to accommodate the necessary rotational deformations cannot be reliably predicted by analytical means alone. Subassemblage test requirements are discussed more completely in Sec. 8.6.3.7.4.

Where conditions in the actual building differ significantly from the test conditions specified in this Chapter, additional testing beyond the requirements described herein may be needed to assure satisfactory brace performance. Prior to developing a test program, the appropriate regulatory agencies should be consulted to assure the test program meets all applicable requirements.

8.6.3.7.2 Symbols. The provisions require the introduction of several new variables. The quantity Δ_{bm} represents both an axial displacement and a rotational quantity. Both quantities are determined by examining the profile of the building at the design story drift, Δ_m and extracting joint lateral and rotational deformation demands.

Determining the maximum rotation imposed on the braces used in the building may require significant effort. The engineer may prefer to select a reasonable value (i.e., interstory drift), which can be simply demonstrated to be conservative for each brace type, and is expected to be within the performance envelope of the braces selected for use on the project.

The brace deformation at first significant yield is used in developing the test sequence described in Sec. 8.6.3.7.6.3. The quantity is required to determine the actual cumulative inelastic deformation demands on the brace. If the nominal yield stress of the steel core were used to determine the test sequence, and significant material over-strength were to exist, the total inelastic deformation demand imposed during the test sequence would be overestimated.

8.6.3.7.3 Definitions. Two types of testing are referred to in this Chapter. The first type is subassemblage testing, described in Sec. 8.6.3.7.4, an example of which is illustrated in Figure C8.6.3.5.

The second type of testing described in Sec. 8.6.3.7.5 as brace specimen testing is permitted to be uniaxial testing.

8.6.3.7.4 Subassemblage Test Specimen. The objective of subassemblage testing is to verify the ability of the brace, and in particular its steel core extension and buckling restraining mechanism, to accommodate the combined axial and rotational deformation demands without failure.

It is recognized that subassemblage testing is more difficult and expensive than uniaxial testing of brace specimens. However, the complexity of the brace behavior due to the combined rotational and

axial demands, and the relative lack of test data on the performance of these systems, indicates that subassembly testing should be performed.

Subassembly testing is not intended to be required for each project. Rather, it is expected that brace manufacturers will perform the tests for a reasonable range of axial loads, steel core configurations, and other parameters as required by the provisions. It is expected that this data will subsequently be available to engineers on other projects. Manufacturers are therefore encouraged to conduct tests that establish the device performance limits to minimize the need for subassembly testing on projects.

Similarity requirements are given in terms of measured axial yield strength of both the prototype and the test specimen braces. This is better suited to manufacturer's product testing than to project-specific testing. Comparison of mill certificate or coupon test results is a way to establish a similarity between the Subassembly Test Specimen brace and the Prototype braces. Once similarity is established, it is acceptable to fabricate Test Specimens and Prototype braces from different heats of steel.

A variety of subassembly configurations are possible for imposing combined axial and rotational deformation demands on a test specimen. Some potential subassemblies are shown in Figure C8.3.6. The subassembly need not include connecting beams and columns provided that the test apparatus duplicates, to a reasonable degree, the combined axial and rotational deformations expected at each end of the brace.

Rotational demands may be concentrated in the steel core extension in the region just outside the buckling restraining mechanism. Depending on the magnitude of the rotational demands, limited flexural yielding of the steel core extension may occur. Rotational demands can also be accommodated by other means, such as tolerance in the buckling restraint layer or mechanism, elastic flexibility of the brace and steel core extension, or through the use of pins or spherical bearing assemblies. It is in the engineer's best interest to include in a subassembly testing all components that contribute significantly to accommodating rotational demands. The use of pins, while accommodating rotational demands, creates the potential for instability; and should be carefully considered by the engineer.

It is intended that the subassembly test specimen be larger in axial-force capacity than the Prototype. However, the possibility exists for braces to be designed with very large axial forces. Should the brace yield force be so large as to make subassembly testing impractical, the engineer is expected to make use of the provisions that allow for alternate testing programs, based on building official approval and qualified peer review. Such programs may include, but are not limited to, non-linear finite element analysis, partial specimen testing, and reduced-scale testing, in combination with full-scale uniaxial testing where applicable or required.

The steel core material was not included in the list of requirements. The more critical parameter, calculated margin of safety for the steel core projection stability, is required to meet or exceed the value used in the prototype. The method of calculating the steel core projection stability should be included in the design methodology.

8.6.3.7.5 Brace Test Specimen. The objective of brace test specimen testing is to establish basic design parameters for the BRBF system.

It is recognized that the fabrication tolerances used by brace manufacturers to achieve the required brace performance may be tighter than those used for other fabricated structural steel members. The engineer is cautioned against including excessively prescriptive brace specifications, as the intent of these provisions is that the fabrication and supply of the braces is achieved through a performance-based specification process. It is considered sufficient that the manufacture of the test specimen and the prototype braces be conducted using the same quality control and assurance procedures, and the braces be designed using the same design methodology.

The engineer should also recognize that manufacturer process improvements over time may result in some manufacturing and quality control and assurance procedures changing between the time of manufacture of the brace test specimen and of the prototype. In such cases reasonable judgment is required.

If the steel core or steel core projection is not biaxially symmetric, the engineer should ensure that the same orientation is maintained in both the test specimen and the prototype.

The allowance of previous test data (similarity) to satisfy these provisions is less restrictive for uniaxial testing than for subassembly testing. Subassembly test specimen requirements are described in Sec. C8.6.3.7.4.

A considerable number of uniaxial tests have been performed on some brace systems and the engineer is encouraged, wherever possible, to submit previous test data to meet these provisions. Relatively few Subassembly tests have been performed. This type of testing is considered a more demanding test of the overall brace performance.

8.6.3.7.5.4 Connection Details. In many cases it will not be practical or reasonable to test the exact brace connections present in the prototype. These provisions are not intended to require such testing. In general, the demands on the steel core extension to gusset-plate connection are well defined due to the known axial capacity of the brace and the limited flexural capacity of the steel core extension. The subsequent design of the bolted or welded connection is relatively well-understood and it is not intended that these connections become the focus of the testing program.

For the purposes of utilizing previous test data to meet the requirements of this Chapter, the requirements for similarity between the brace and subassembly brace test specimen can be considered to exclude the steel core extension connection to frame.

8.6.3.7.5.5 Materials. The intent of the provisions is to allow test data from previous test programs to be presented where possible. See Sec.8.6.3.7.4 for additional commentary.

8.6.3.7.5.7 Bolts. For the brace test specimen, it is crucial to treat the ultimate load that can be expected in the braces as the load at which bolt slippage should be prevented. Prevention of bolt slippage increases the chances of achieving a successful test and protects laboratory setup. In terms of the nomenclature used by the Research Council on Structural Connections (RCSC), prevention of bolt slippage implies using service-level load capacities when sizing bolted connections. Bolted connections sized using service-level capacities per RCSC will provide at least a 90 percent reliability that the bolts will not slip at the maximum force developed by the braces during the test.

The intent of this provision is to ensure that the bolted end-connections of the brace test specimen reasonably represent those of the prototype. It is possible that due to fabrication or assembly constraints variations in faying-surface preparation, bolt-hole fabrication, and bolt size may occur. In certain cases, such variations may not be detrimental to the qualification of a successful cyclic test. Final acceptability of variations in brace-end bolted connection rest on the opinion of the building official or qualified peer reviewer.

8.6.3.7.6.3 Loading Sequence. The subassembly test specimen is required to undergo combined axial and rotational deformations similar to those in the prototype. It is recognized that identical braces, in different locations in the building, will undergo different maximum axial and rotational deformation demands. In addition, the maximum rotational and axial deformation demands may be different at each end of the brace. The engineer is expected to make simplifying assumptions to determine the most appropriate combination of rotational and axial deformation demands for the testing program.

Some subassembly configurations will require that one deformation quantity be fixed while the other is varied as described in the test sequence above. In such a case, the rotational quantity may be applied and maintained at the maximum value, and the axial deformation applied according to the

test sequence. The engineer may wish to perform subsequent tests on the same subassembly specimen to bound the brace performance.

The loading sequence requires each tested brace to achieve ductilities corresponding to 1.5 times the design story drift and a cumulative inelastic axial ductility capacity of 140. Both of these requirements are based on a study in which a series nonlinear dynamic analyses was conducted on model buildings in order to investigate the performance of this system; the ductility capacity requirement represents a mean of response values and the cumulative ductility capacity requirement is a mean plus standard deviation value (Sabelli, 2001). In that study, buildings were designed and models of brace hysteresis selected so as to maximize the demands on braces. It is therefore believed that these requirements are more severe than the demands that typical braces in typical designs would face under their design-basis ground motion, perhaps substantially so. It is also expected that as more test data and building analysis results become available these requirements may be revisited.

The ratio of brace yield deformation (D_{by}) to the brace deformation corresponding to the design story drift (D_{bm}) must be calculated in order to define the testing protocol. This ratio is typically the same as the ratio of the displacement amplification factor (as defined in the applicable building code) to the actual overstrength of the brace; the minimum overstrength is defined in Sec. 8.6.3.2.1.1.1. Engineers should note that there is a minimum brace deformation demand corresponding to 1% story drift (8.6.3.7.2); provision of overstrength beyond that required to so limit the design story drift may not be used as a basis to reduce the testing protocol requirements.

Table C8.6.3.7.1 shows an example brace test protocol. For this example, it is assumed that the brace deformation corresponding to the design story drift is four times the yield deformation; it is also assumed that the design story drift is larger than the 1 percent minimum. The test protocol is then constructed from steps 1-4 of Sec. 8.6.3.7.6.3. In order to calculate the cumulative inelastic deformation, the cycles are converted from multiples of brace deformation at the design story drift (D_{bm}) to multiples of brace yield deformation (D_{by}). Since the cumulative inelastic drift at the end of the $1.5D_{bm}$ cycles is less than the minimum of $140D_{by}$ required for brace tests, additional cycles to D_{bm} are required. At the end of three such cycles, the required cumulative inelastic deformation has been reached.

Table C8.6.3.7.1 Example Brace Testing Protocol

Cycle Deformation	Deformation Inelastic Deformation	Inelastic	Cumulative
6 @ $D_{by} = 0D_{by}$	$= 6*4*(D_{by} - D_{by})$	$= 0D_{by}$	$0D_{by}$
4 @ $0.5D_{bm} = 16D_{by}$	$= 4 @ 2.0D_{by}$	$= 4*4*(2.0D_{by} - D_{by})$	$= 16D_{by} \quad 0D_{by} \quad +16D_{by}$
4 @ $D_{bm} = 64D_{by}$	$= 4 @ 4.0D_{by}$	$= 4*4*(4.0D_{by} - D_{by})$	$= 48D_{by} \quad 16D_{by} \quad +48D_{by}$
2 @ $1.5D_{bm} = 104D_{by}$	$= 2 @ 6.0D_{by}$	$= 2*4*(6.0D_{by} - D_{by})$	$= 40D_{by} \quad 64D_{by} \quad +40D_{by}$
3 @ $D_{bm} = 140D_{by}$	$= 3 @ 4.0D_{by}$	$= 3*4*(4.0D_{by} - D_{by})$	$= 36D_{by} \quad 104D_{by} \quad +36D_{by}$

$$\text{Cumulative Inelastic Deformation at End of Protocol} = 140 D_{by}$$

Dynamically applied loads are not required by these provisions. The use of slowly applied cyclic loads, widely described in the literature for brace specimen tests, is acceptable for the purposes of these provisions. It is recognized that dynamic loading can considerably increase the cost of testing, and that few laboratory facilities have the capability to apply dynamic loads to very large-scale test specimens. Furthermore, the available research on dynamic loading effects on steel test specimens has not demonstrated a compelling need for such testing.

If rate-of-loading effects are thought to be potentially significant for the steel core material used in the prototype, it may be possible to estimate the expected change in behavior by performing coupon tests at low (test cyclic loads) and high (dynamic earthquake) load rates. The results from brace tests would then be factored accordingly.

8.6.3.7.8 Materials Testing Requirements. Tension testing of the steel core material used in the manufacture of the test specimens is required. In general, there has been good agreement between coupon test results and observed tensile yield strengths in full-scale uniaxial tests. Material testing required by this appendix is consistent with that required for testing of beam-to-column moment connections. For further information on this topic refer to Section CS8 of AISC Seismic.

8.6.3.7.10 Acceptance Criteria. The acceptance criteria are written so that the minimum testing data that must be submitted is at least one subassembly test and at least one uniaxial test. In most cases the subassembly test also qualifies as a uniaxial test provided the requirements of Sec. 8.6.3.7.5 are met. If project specific subassembly testing is to be performed it may be simplest to perform two subassembly tests to meet the requirements of this section. For the purposes of these requirements a single subassembly test incorporating two braces in a chevron or other configuration is also considered acceptable.

Depending on the means used to connect the test specimen to the subassembly or test apparatus, and the instrumentation system used, bolt slip may appear in the load vs. displacement history for some tests. This may appear as a series of spikes in the load vs. displacement plot and is not generally a cause for concern, provided the behavior does not adversely affect the performance of the brace or brace connection.

These acceptance criteria are intended to be minimum requirements. The 1.3 limit in Sec. 8.6.3.7.10.5 is essentially a limitation on β . These provisions were developed assuming that $\beta < 1.3$ so this provision has been included in the test requirements. Most currently available braces should be able to satisfy this requirement.

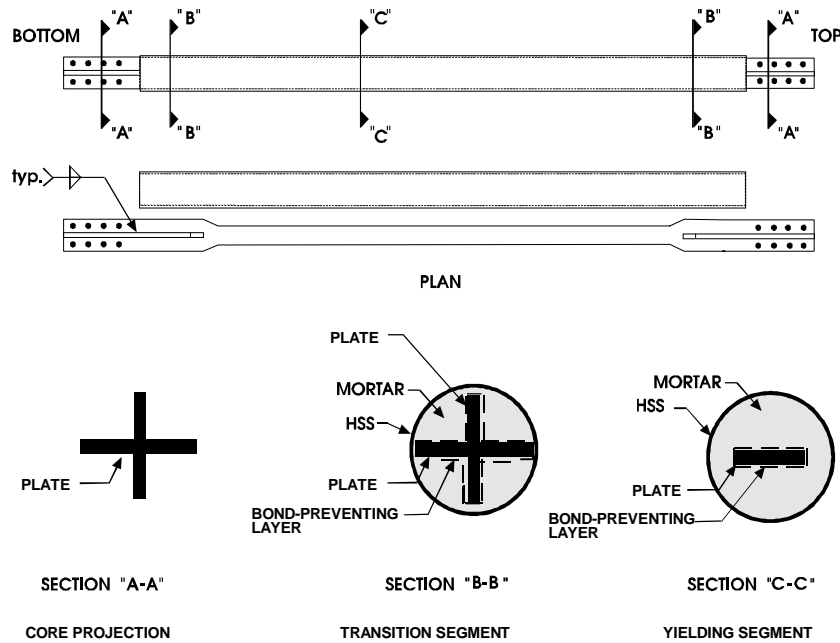

Figure C8.6.3.1 Detail of a Buckling Restrained Brace (Courtesy of R. Tremblay).

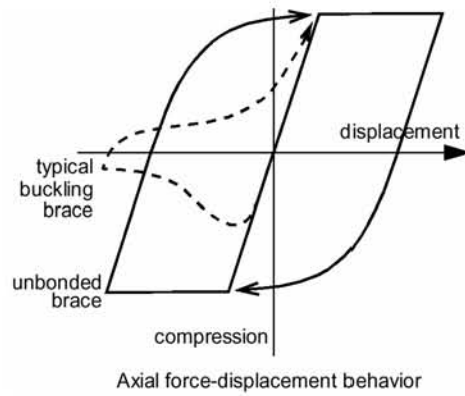

Figure 8.6.3.2 Detail of buckling-restrained (unbonded) brace hysteretic behavior (Courtesy of Seismic Isolation Engineering).

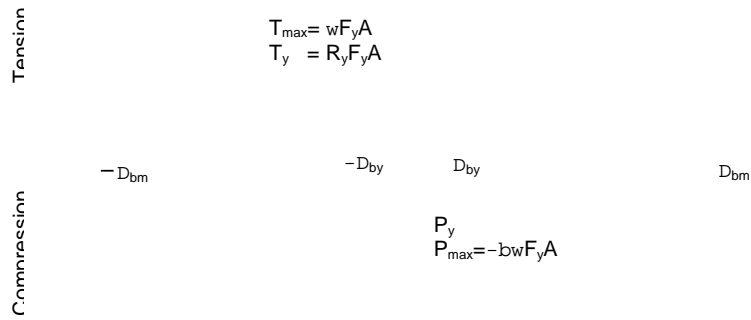

Figure C8.6.33 Diagram of brace force-displacement.

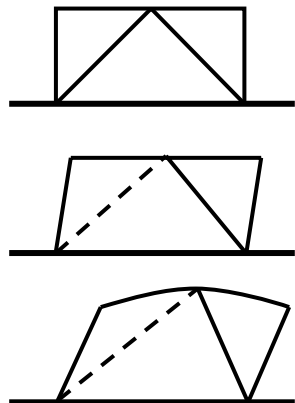

Figure C8.6.3.4 Post-yield, pre-mechanism change in deformation mode for V- and Inverted-V BRBF.

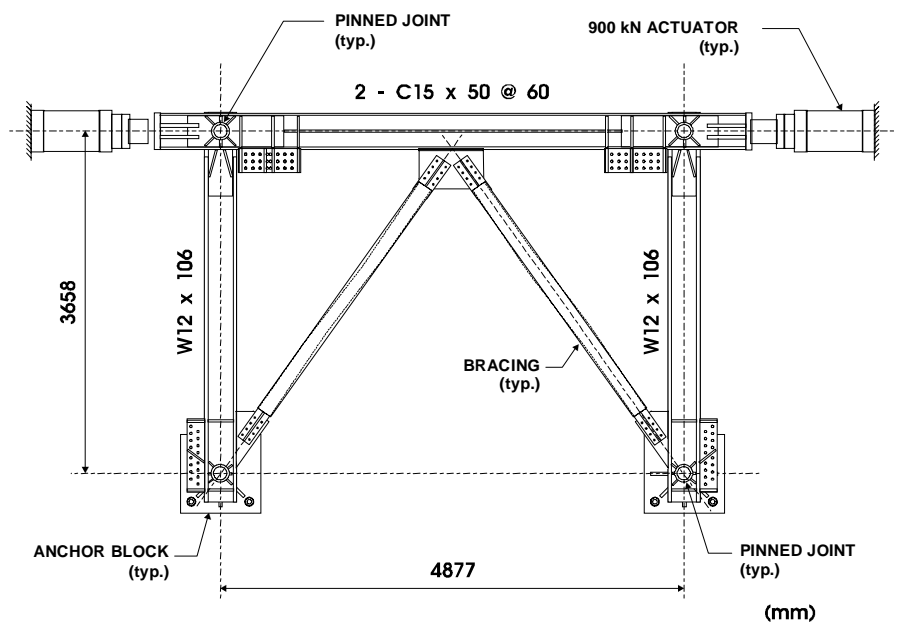
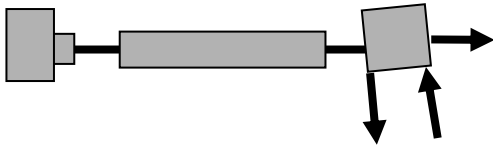

Figure C8.6.3.5 Example of test subassemblage.



Eccentric Loading of Brace



Loading of Brace with Constant Imposed

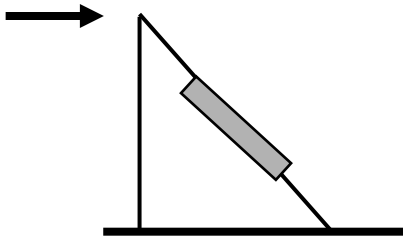

Loading of Brace and Column

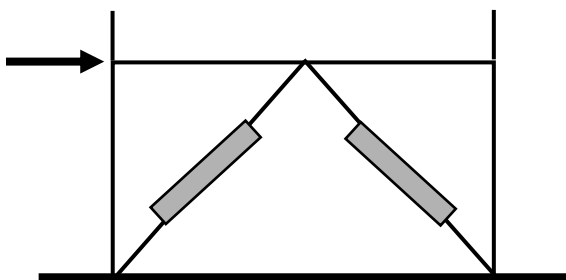

Loading of Braced Frame

Figure C8.6.3.6 Schematic of possible test subassemblages.

8.7. SPECIAL STEEL PLATE WALLS

8.7.3 Scope. These provisions for SSPWs are intended for use in conjunction with AISC Seismic.

In special steel plate walls (SSPWs), the slender unstiffened steel plates (webs) connected to surrounding horizontal and vertical boundary elements (i.e., HBEs and VBEs) are designed to yield and behave in a ductile hysteretic manner during earthquakes. All HBEs are also rigidly connected to the VBEs with moment resisting connections able to develop the expected plastic moment of the HBEs. Each web must be surrounded by boundary elements.

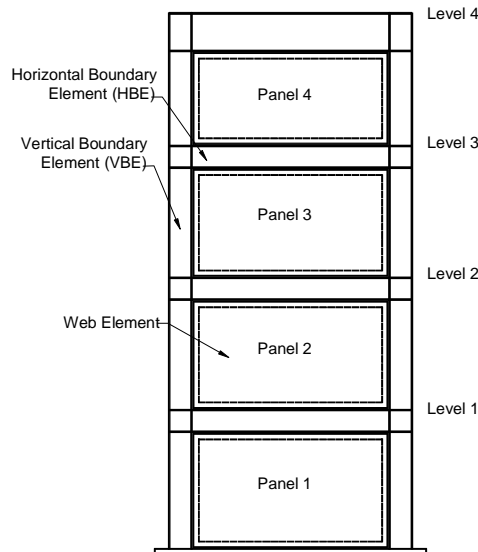

Figure C8.7.3.1 Schematic of Special Steel Plate Walls.

Experimental research on SSPWs subjected to cyclic inelastic quasi-static and dynamic loading (Thorburn, et al., 1983; Timler and Kulak, 1983; Tromposch and Kulak, 1987; Roberts and Sabouri-Ghomi, 1992; Cassese et al., 1993; Driver et al., 1997; Elgaaly 1998; Rezai, 1999; Lubell et al., 2000;) has demonstrated their ability to behave in a ductile manner and dissipate significant amounts of energy. This has been confirmed by analytical studies using finite element analysis and other analysis techniques (Sabouri-Ghomi and Roberts, 1992; Elgaaly et al., 1993; Elgaaly and Liu, 1997; Driver et al., 1997).

Yielding of the webs occurs by development of tension field action at an angle close to 45° from the vertical, and buckling of the plate in the orthogonal direction. Past research shows that the sizing of VBEs and HBEs in a SSPW makes it possible to develop this tension field action across the entire webs. Except for cases with very stiff HBEs and VBEs, yielding in the webs develops in a progressive manner across each panel. Because the webs do not yield in compression, continued yielding upon repeated cycles of loading is contingent upon the SSPW being subjected to progressively larger drifts, except for the contribution of plastic hinging developing in the HBEs to the total system hysteretic energy. In past research (Driver et al. 1997), the yielding of boundary elements contributed approximately 25-30 percent of the total load strength of the system.

With the exception of plastic hinging at the ends of HBEs, the surrounding horizontal and vertical boundary elements are designed to remain essentially elastic when the webs are fully yielded. Plastic hinging at the ends of HBEs is needed to develop the plastic collapse mechanism of this system. Plastic hinging in the middle of HBEs, which could partly prevent yielding of the webs, is deemed undesirable. Cases of both desirable and undesirable yielding in VBEs have been observed in past testing. In absence of a theoretical formulation to quantify the conditions leading to acceptable yielding (and supporting experimental validation of this formulation), the conservative requirement of elastic VBE response is justified.

Research literature often compares the behavior of steel plate walls to that of a vertical plate girder, indicating that the webs of a SSPW resist shears by tension field action (similarly to the webs of a plate girder) and that the VBEs of a SSPW resist overturning moments (similarly to the flanges of a plate girder). While this analogy is useful in providing a conceptual understanding of the behavior of SSPWs, many significant differences exist in the behavior and strength of the two systems. Past research shows that the use of structural shapes for the VBEs and HBEs in SSPWs (as well as other dimensions and details germane to SSPWs) favorably impacts orientation of the angle of development of the tension field action, and makes possible the use of very slender webs (having negligible diagonal compressive strength). Sizeable top and bottom HBEs are also required in SSPWs to anchor the significant tension fields that develop at these ends of the structural system. Limits imposed on the maximum web slenderness of plate girders to prevent flange buckling, or due to transportation requirements, are also not applicable to SSPWs which are constructed differently. For these reasons, the use of Appendix G in AISC LRFD Specifications for the design of SSPW is not appropriate.

8.7.4 Webs. The specified minimum yield stress of steel used for SSPW is per Sec. 6.1. However, the webs of SSPWs could also be of special highly ductile low yield steel having specified minimum yield in the range of 12 to 33 ksi.

8.7.4.1. The lateral shears are carried by tension fields that develop in the webs stressing in the direction α , defined in Sec. 8.7.4. To determine α , when the HBEs and VBEs boundary elements of a web are not identical, the average of HBE areas may be taken in the calculation of A_b , and the average of VBE areas and inertias may be respectively used in the calculation A_c , and I_c .

Plastic shear strength of panels is given by $0.5 R_y F_y t_w L_{cf} \sin 2 \alpha$. Nominal strength is obtained by dividing this value by a system overstrength, as defined by FEMA 369, and taken as 1.2 for SSPWs (Berman and Bruneau 2003).

The above plastic shear strength is obtained from the assumption that, for purposes of analysis, each web may be modeled by a series of inclined pin-ended strips Figure C8.7.4-1, oriented at angle α . Past research has shown this model to provide realistic results, as shown in Figure C8.7.4-2 for example, provided at least 10 equally spaced strips are used to model each panel.

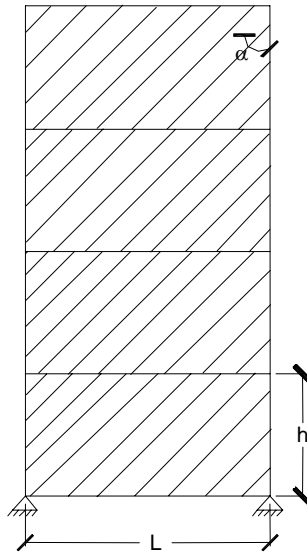
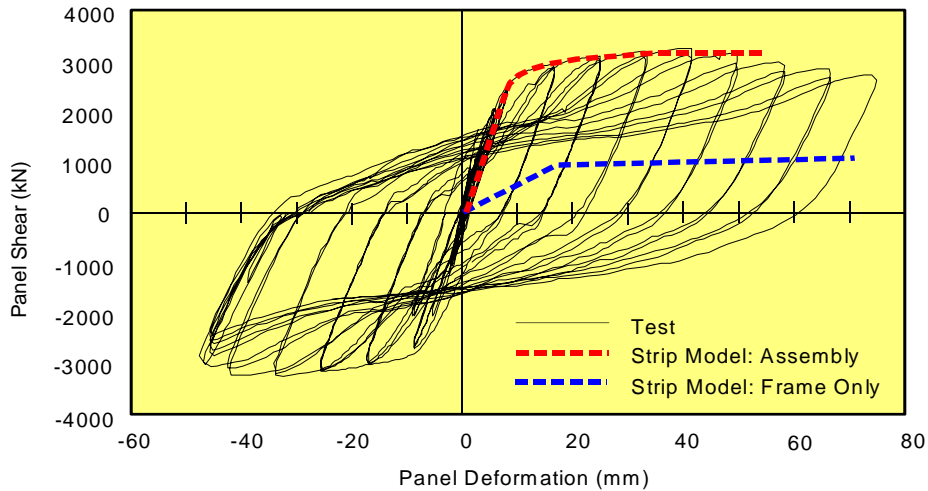

Figure C8.7.4-1 Strip model of a SSPW.



DRIVER ET. AL.'S TEST RESULTS FOR
LOWER PANEL OF MULTI-STOREY SSPW FRAME

Figure C8.7.4-2 Comparison of Experimental Results and
Strength predicted by Strip Model (Driver et al. 1997).

8.7.4.2 Panel Aspect Ratio. Past research shows that modeling SSPWs with strips is reasonably accurate for panel aspect ratios of L/h that exceed 0.8 (Rezai 1999). Additional horizontal intermediate boundary elements could be introduced in SSPW to modify the L/h of panels having such an aspect ratio less than 0.8.

No theoretical upper bound exists on L/h (provided sufficiently stiff HBEs can be provided), but a maximum value of 2.5 is specified on the basis that past research has not investigated the seismic behavior of SSPWs having L/h greater than 2.0. Excessive flexibility of HBEs is of concern for L/h ratio beyond the specified limit. For conditions beyond the specified limits, other FEM methods shall be used which correlate with published test data.

8.7.4.2 Openings in webs. Large openings in webs create significant local demands and thus must have HBE and VBE in a similar fashion as the remainder of the system. When openings are required, SSPWs can be subdivided in smaller SSPW segments by using HBEs and VBEs bordering the openings. SSPWs with holes in the web not surrounded by HBEs/VBEs have not been tested. The provisions will allow other openings that can be justified by analysis or testing.

8.7.4.4 Maximum Slenderness Ratio for Plates. A limit on the slenderness of plate elements in SSPW is needed to ensure that adequate cyclic ductility is provided. The limit provided is consistent with successful tests of this system.

8.7.5 Connections of Webs to Boundary Elements. The required strength of web connections to the surrounding HBEs and VBEs shall develop the expected tensile strength of the webs. Net-sections shall also provide this strength for the case of bolted connections.

The strip model can be used to model the behavior of SSPWs and the tensile yielding of the webs at angle α . A single angle of inclination taken as the average for all the panels may be used to analyze the entire wall. The expected tensile strength of the web strips shall be defined as

$$R_y F_y A_s$$

where A_s is the area of a strip, equal to

$$A_s = (L \cos \alpha + H \sin \alpha) / n$$

where L and H are the width and height of a panel, n is the number of strips per panel, and n shall be taken greater than or equal to 10.

This analysis method has been shown, though correlation with physical test data, to adequately predict SSPW performance. It is recognized, however, that other advanced analytical techniques (such as the Finite Element Method (FEM)) may also be used for design of SSPWs. If such non-linear (geometric and material) FEM models are used, they should be calibrated against published test results to ascertain reliability for application.

8.7.6 Horizontal and Vertical Boundary Elements (HBEs and VBEs). Per capacity design principles, all edge boundary elements (HBEs and VBEs) shall be designed to resist the maximum forces generated by the tension field action of the webs fully yielding. Axial forces, shears, and moments develop in the boundary elements of the SSPW as a result of the response of the system to the overall overturning and shear, and this tension field action in the webs. Actual web thickness must be considered for this calculation, because webs thicker than required may have been used due to availability, or minimum thickness required for welding.

At the top panel of the wall, the vertical components of the tension field shall be anchored to the HBE. The HBE shall have sufficient strength to allow development of full tensile yielding across the panel width.

At the bottom panel of the wall, the vertical components of the tension field shall be anchored to the HBE. The HBE shall have sufficient strength to allow development of full tensile yielding across the panel width. This may be accomplished by continuously anchoring the HBE to the foundation.

For intermediate HBEs of the wall, the anticipated variation between the top and bottom web normal stresses acting on the HBE is usually small, or null when webs in the panel above and below the HBE have identical thickness. While top and bottom HBEs are typically of substantial size, intermediate HBEs are relatively smaller.

Beyond the exception mentioned in Sec. 8.7, in some instances, the engineer may be able to justify yielding of the boundary elements by demonstrating that the yielding of this edge boundary element will not cause reduction on the SSPW shear capacity to support the demand and will not cause a failure in vertical gravity carrying capacity.

Forces and moments in the members (and connections), including those resulting from tension field action, may be determined from a plane frame analysis. The web is represented by a series of inclined pin-ended strips, as described in C8.7.4-1. A minimum of 10 equally spaced pin-ended strips per panel will be used in such an analysis.

A number of analytical approaches are possible to achieve capacity design and determine the same forces acting on the vertical boundary elements. Some example methods applicable to SSPWs follow. In all cases, actual web thickness must be considered, for reasons described earlier.

Non-linear push-over analysis

A model of the SSPW can be constructed in which bi-linear elasto-plastic web elements of strength $R_y F_y A_s$ are introduced in the direction α . Bi-linear plastic hinges can also be introduced at the ends of the horizontal boundary elements. Standard push-over analysis conducted with this model will provide axial forces, shears, and moments in the boundary frame when the webs develop yielding. Separate checks are required to verify that plastic hinges do not develop in the horizontal boundary elements, except at their ends.

Combined linear elastic computer programs and capacity design concept

The following four-step procedure provides reasonable estimates of forces in the boundary elements of SSPW systems.

Lateral Forces: Use combined model, boundary elements and web elements, to come up with the demands in the web and the boundary elements based on the code required base shear. The web elements shall not be considered as vertical-load carrying elements.

Gravity Load (Dead Load and Live Load): Apply gravity loads to a model with only gravity frames. The web elements shall not be considered as vertical-load carrying elements.

Without any overstrength factors, design the boundary elements using the demands based on combination forces of the above steps 1 and 2.

Boundary Element Capacity Design Check: Check the boundary element for the maximum capacity of the web elements in combination with the maximum possible axial load due to over-turning moment. Use the axial force obtained from step 1 above and multiply by overstrength factor Ω_o . Apply load from web elements ($R_y F_y A_s$) in the direction of α . For this capacity design check use material strength reduction factor of 1.0.

Indirect Capacity Design Approach

The CSA-S16-02 (CSA 2002) proposes that loads in the vertical boundary members can be determined from the gravity loads combined with the seismic loads increased by the amplification factor,

$$B = V_e / V_u$$

where

V_e = expected shear strength, at the base of the wall, determined for the web thickness supplied

$$= 0.5 R_y F_y t_w L \sin 2\alpha$$

V_u = factored lateral seismic force at the base of the wall

In determining the loads in VBEs, the amplification factor, B , need not be taken as greater than R .

The VBE design axial forces shall be determined from overturning moments defined as follows:

(i) the moment at the base is $B \cdot M_u$, where M_u is the factored seismic overturning moment at the base of the wall corresponding to the force V_u ;

(ii) the moment $B \cdot M_u$ extends for a height H but not less than two stories from the base; and

(iii) the moment decreases linearly above a height H to B times the overturning moment at one story below the top of the wall, but need not exceed R times the factored seismic overturning moment at the story under consideration corresponding to the force V_u .

The local bending moments in the VBEs due to tension field action in the web shall be multiplied by the amplification factor B .

Preliminary Design

For preliminary proportioning of HBEs, VBEs, and webs, a SSPW wall may be approximated by a vertical truss with tension diagonals. Each web is represented by a single diagonal tension brace within the story. For an assumed angle of inclination of the tension field, the web thickness, t_w , may be taken as:

$$t_w = \frac{2A\Omega_s \sin \theta}{L \sin 2\alpha}$$

where

A = area of the equivalent tension brace

θ = angle between the vertical and the longitudinal axis of the equivalent diagonal brace

L = the distance between VBE centerlines

α = assumed angle of inclination of the tension field measured from the vertical per Sec. 8.7.4

Ω_s = the system overstrength factor as defined by FEMA 369 and taken as 1.2 for SSPWs (Berman and Bruneau 2003).

Determination of A is originally estimated from an equivalent brace size to meet the structure's drift requirements.

8.7.6.3 Boundary Element Compactness. Some amount of local yielding is expected in the HBEs and VBEs to allow development of the plastic mechanism of SSPW systems. For that reason, HBEs and VBEs shall comply with the requirements in AISC Seismic Table I-8-1 for SMFs.

8.7.6.5 Lateral Bracing. Providing stability of SSPW systems boundary elements is necessary for proper performance of the system. The lateral bracing requirements for HBEs are provided

to be consistent with beams in SMFs for both strength and stiffness. In addition, all intersections of HBEs and VBEs must be braced to ensure stability of the entire panel.

8.7.6.7 Panel Zone. Panel zone requirements are not imposed for intermediate HBEs. These are expected to be small HBEs connecting to sizeable VBEs. The engineer should use judgment to identify special situations in which the panel zone adequacy of VBEs next to intermediate HBEs should be verified.

8.7.6.8 Stiffness of Vertical Boundary Elements. This requirement is intended to prevent excessive in-plane flexibility and buckling of VBEs. Opportunity exists for future research to confirm or improve the applicability this requirement.

REFERENCES

- Astaneh, A., 1998, "Seismic Behavior and Design of Gusset Plates for Braced Frames," Steel Tips, Structural Steel Education Council, Moraga, California.
- Astaneh-Asl, A., and Zhao, Q. (2002) "Cyclic Behavior of Steel Shear Wall Systems", Proceedings, 2002 Annual Stability Conference, Structural Stability Research Council, April 25-27, Seattle.
- Astaneh-Asl, A. (2001) "Seismic Behavior and Design of Steel Shear Walls", Steel Technical Information and Product Services Report (Steel TIPS), Structural Steel Educational Council, Moraga, California. (available at www.aisc.org).
- Berman, J., Bruneau, M. (2003). "Plastic Analysis and Design of Steel Plate Shear Walls", ASCE Journal of Structural Engineering, (in press).
- Caccese, V., Elgaaly, M., and Chen, R., (1993), "Experimental Study of Thin Steel-Plate Shear Walls Under Cyclic Load", Journal of Structural Engineering, ASCE, Vol. 119, No. 2, Feb. 1993, pp. 573-587.
- Clark, P., Aiken, I., Kasai, K., Ko, E., and Kimura, I., 1999, "Design Procedures for Buildings Incorporating Hysteretic Damping Devices," *Proceedings 68th Annual Convention*, pp. 355-371, Structural Engineers Association of California, Sacramento, CA.
- Clark, P., Kasai, K., Aiken, I., Kimura, I., 1999, "Evaluation of Simplified Design Approaches for Structures with Yielding Steel Braces for Energy Dissipation," *Proceedings of the 1999 Annual Meeting of the Los Angeles Tall Buildings Structural Design Council*, Los Angeles, CA.
- Driver, R.G., Kulak, G.L., Kennedy, D.J.L., and Elwi, A.E. (1997), "Seismic Behavior of Steel Plate Shear Walls", Structural Engineering Report No. 215, Department of Civil Engineering, University of Alberta, Edmonton, Alberta, Canada.
- Elgaaly M. (1998), "Thin Steel Plate Shear Walls Behavior and Analysis", *Thin Walled Structures*, Vol. 32, pp. 151-180.
- Elgaaly, M., Caccese, V., and Du, C. (1993), "Postbuckling Behavior of Steel-Plate Shear Walls Under Cyclic Loads", Journal of Structural Engineering, ASCE, Vol. 119, No. 2, Feb. 1993, pp. 588-605.
- Elgaaly, M., and Lui, Y., (1997), "Analysis of Thin-Steel-Plate Shear Walls", Journal of Structural Engineering, ASCE, Vol. 123, No. 11, Nov. 1997, pp 1487-1496.
- Kalyanaraman, V., Sridhara, B.N., Mahadevan, K., 1994, "Sleeved Column System," *Proceedings of the SSRC Task Group Meetings and Task Force Sessions*, Lehigh University, Bethlehem, PA.

- Kalyanaraman, V., Sridhara, B.N., Thairani, V., 1998, "Core Loaded Earthquake Resistant Bracing Design," *Proceedings of the 2nd International Conference on Steel Construction*, San Sebastian, Spain.
- Kalyanaraman, V., Sridhara, B.N., Mahadevan, K., Thairani, V., and Ramachandran, B., 1988, A Sleeved Bracing System for Earthquake Resistant Design of Tall Buildings, Symposium on Earthquake Engineering, Univ. of Roorkee Dec. 17-19, 1998.
- Kasai, K., Fu, Y., and Watanabe, A., 1998, "Passive Control Systems for Seismic Damage Mitigation," *Journal of Structural Engineering*, Vol. 124, No. 5, (May), pp. 501-512, American Society of Civil Engineers, Reston, VA.
- Lubell, A.S., Prion, H.G.L., Ventura, C.E., and Rezai, M. (2000), "Unstiffened Steel Plate Shear Wall Performance Under Cyclic Loading", *Journal of Structural Engineering*, ASCE, Vol. 126, No.4, April 2000, pp. 453-460.
- Prasad, B. 1992, "Experimental Investigation of Sleeved Column," *Proceedings of the 33rd Structural Dynamics and Materials Conference*, American Institute of Aeronautics and Astronautics, Dallas.
- Reina, P., and Normile, D., 1997, "Fully Braced for Seismic Survival," *Engineering News-Record*, July 21, pp. 34-36, The McGraw Hill Companies, New York, NY.
- Rezai, M. (1999), "Seismic Behavior of Steel Plate Shear Walls by Shake Table Testing", Ph.D. Dissertation, University of British Columbia, Vancouver, British Columbia, Canada.
- Roberts, T.M., and Sabouri-Ghomi, S. (1992), "Hysteretic Characteristics of Unstiffened Perforated Steel Plate Shear Walls", *Thin Walled Structures*, Vol. 14, pp. 139-151.
- Sabelli, R., 2001, "Research on Improving the Design and Analysis of Earthquake-Resistant Steel Braced Frames," EERI/FEMA NEHRP Fellowship Report, Oakland, California.
- Sabouri-Ghomi, S., and Roberts, T.M. (1992), "Nonlinear Dynamic Analysis of Steel Plate Shear Walls Including Shear and Bending Deformations", *Engineering Structures*, Vol. 14, No. 3, pp. 309-317.
- Seismic Isolation Engineering for Nippon Steel Corporation, 1999, "Tests of Nippon Steel Corporation Unbonded Braces." Report to Ove Arup & Partners, California.
- Seismic Isolation Engineering, 1999," Report on Pre-Prototype Tests of Yielding Braces," California.
- Serrette, R. 1996. Shear Wall Values for Light Weight Steel Framing. American Iron and Steel Institute.
- Sridhara, B.N., 1990, "Sleeved Column-As a Basic Compression Member," *4th International Conference of Steel Structures and Space Frames*, Singapore.
- Thorburn, L.J., Kulak, G.L., and Montgomery, C.J. (1983), "Analysis of Steel Plate Shear Walls", *Structural Engineering Report No. 107*, Department of Civil Engineering, University of Alberta, Edmonton, Alberta, Canada.
- Timler, P.A. and Kulak, G.L. (1983), "Experimental Study of Steel Plate Shear Walls", *Structural Engineering Report No. 114*, Department of Civil Engineering, University of Alberta, Edmonton, Alberta, Canada.
- Tremblay, R., Degrange, G., and Blouin, J., 1999, "Seismic Rehabilitation of a Four-Storey Building with a Stiffened Bracing System," *Proc. 8th Can. Conf. on Earthquake Engrg.*, Canadian Association for Earthquake Engineering, Vancouver, B.C., 549-554.

Tromposch, E.W., and Kulak, G.L. (1987), "Cyclic and Static Behaviour of Thin Panel Steel Plate Shear Walls", Structural Engineering Report No. 145, Department of Civil Engineering, University of Alberta, Edmonton, Alberta, Canada.

Wada, A., Connor, J., Kawai, H., Iwata, M., and Watanabe, A., 1994, "Damage Tolerant Structure," *ATC-15-4 Proceedings of Fifth US-Japan Workshop on the Improvement of Building Structural Design and Construction Practices*, pp. 27-39, Applied Technology Council, Redwood City, CA.

Wada, A., Saeki, E., Takeuchi, T., and Watanabe, A., c. 1998, "Development of Unbonded Brace," Nippon Steel's Unbonded Braces (promotional document), pp. 1-16, Nippon Steel Corporation Building Construction and Urban Development Division, Tokyo, Japan.

Watanabe, A., Hitomi Y., Saeki, E., Wada, A., and Fujimoto, M., 1988, "Properties of Brace Encased in Buckling-Restraining Concrete and Steel Tube," *Proceedings of Ninth World Conference on Earthquake Engineering*, Vol. IV, pp. 719-724, Japan Association for Earthquake Disaster Prevention, Tokyo-Kyoto, Japan.

This page is intentionally left blank.

Chapter 9 Commentary

CONCRETE STRUCTURE DESIGN REQUIREMENTS

9.1 GENERAL

9.1.2 References. The main concern of Chapter 9 is the proper detailing of reinforced concrete construction for earthquake resistance. The bulk of the detailing requirements in this chapter are contained in ACI 318. The commentary for ACI 318 contains a valuable discussion of the rationale behind detailing requirements and is not repeated here.

9.2 GENERAL DESIGN REQUIREMENTS

9.2.1 Classification of shear walls. In the 2000 *Provisions*, shearwalls are classified by the amount and type of detailing required. This classification was developed to facilitate assigning shearwalls to seismic design categories.

9.2.2 Modifications to ACI 318. The modifications noted for ACI 318 are: changes in load factors necessary to coordinate with the equivalent yield basis of this document, additional definitions and provisions necessary for seismic design requirements for structural systems composed of precast elements, and changes that incorporate certain features of the detailing requirements for reinforced concrete that have been adopted into the 1997 *Uniform Building Code* and the 2000 *International Building Code*.

Procedures for design of a seismic-force-resisting structural system composed of precast elements interconnected predominately by dry joints require prior acceptance testing of modules of the generic structural system because with the existing state-of-knowledge, it is inappropriate to propose code provisions without such verification.

The complexity of structural systems, configurations, and details possible with precast concrete elements requires:

1. Selecting functional and compatible details for connections and members that are reliable and can be built with acceptable tolerances;
2. Verifying experimentally the inelastic force-deformation relationships for welded, bolted, or grouted connections proposed for the seismic resisting elements of the building; and
3. Analyzing the building using those connection relationships and the inelastic reversed cyclic loading effects imposed by the anticipated earthquake ground motions.

Research conducted to date (Cheok and Lew, 1991; Elliott et al, 1992; Englekirk, 1987; French et al, 1989; BSSC, 1987; Hawkins and Englekirk, 1987; Jayashanker and French, 1988; Mast, 1992; Nakaki and Englekirk, 1991; Neille, 1977; New Zealand Society, 1991; Pekau and Hum, 1991; Powell et al, 1993; Priestley, 1991; Priestley and Tao, 1992; Stanton et al, 1986; Stanton et al, 1991) documents concepts for design using dry connections and the behavior of structural systems and subassemblages composed of precast elements both at and beyond peak strength levels for nonlinear reversed cyclic loadings.

Use of prestressing tendons. Sec. 9.2.2.1.4 defines conditions under which prestressing tendons can be used, in conjunction with deformed reinforcing bars, in frames resisting earthquake forces. As documented in Ishizuka and Hawkins (1987), if those conditions are met no modification is necessary to the R and C_d factors of Table 4.3-1 when prestressing is used. Satisfactory seismic performance can be obtained when prestressing amounts greater than those permitted by Sec. 9.2.2.1.4 are used. However, as documented by Park and Thompson (1977) and Thompson and Park (1980) and as required by the combination of New Zealand Standards 3101:1982 and 4203:1992, ensuring satisfactory performance requires modification of the R and C_d factors.

9.3 SEISMIC DESIGN CATEGORY B

Special details for ductility and toughness are not required in Seismic Design Category B.

9.3.1 Ordinary moment frames. Since ordinary frames are permitted only in Seismic Design Categories A and B, they are not required to meet any particular seismic requirements. Attention should be paid to the often overlooked requirement for joint reinforcement in Sec.11.11.2 of ACI 318.

9.4 SEISMIC DESIGN CATEGORY C

A frame used as part of the seismic-force-resisting system in Seismic Design Category C is required to have certain details that are intended to help sustain integrity of the frame when subjected to deformation reversals into the nonlinear range of response. Such frames must have attributes of intermediate moment frames. Structural (shear) walls of buildings in Seismic Design Category C are to be designed in accordance with the requirements of ACI 318.

9.4.1.1 Moment frames. The concept of moment frames for various levels of hazard zones and of performance is changed somewhat from the provisions of ACI 318. Two sets of moment frame detailing requirements are defined in ACI 318, one for “regions of high seismic risk” and the other for “regions of moderate seismic risk.” For the purposes of this document, the “regions” are made equivalent to Seismic Design Categories in which “high risk” means Seismic Design Categories D and E and “moderate risk” means Seismic Design Category C. This document labels these two frames the “special moment frame” and the “intermediate moment frame,” respectively.

The level of inelastic energy absorption of the two frames is not the same. The *Provisions* introduce the concept that the R factors for these two frames should not be the same. The preliminary version of the *Provisions* (ATC 3-06) assigned the R for ordinary frames to what is now called the intermediate frame. In spite of the fact that the R factor for the intermediate frame is less than the R factor for the special frame, use of the intermediate frame is not permitted in the higher Seismic Design Categories (D, E, and F). On the other hand, this arrangement of the *Provisions* encourages consideration of the more stringent detailing practices for the special frame in Seismic Design Category C because the reward for use of the higher R factor can be weighed against the higher cost of the detailing requirements. The *Provisions* also introduce the concept that an intermediate frame may be part of a dual system in Seismic Design Category C.

The differences in the performance basis of the requirements for the two types of frames might be summarized briefly as follows (see the commentary of ACI 318 for a more detailed discussion of the requirement for the special frame):

1. The shear strength of beams and columns must not be less than that required when the member has yielded at each end in flexure. For the special frame, strain hardening and other factors are considered by raising the effective tensile strength of the bars to 125 percent of specified yield. For the intermediate frame, an escape clause is provided in that the calculated shear using double the prescribed seismic force may be substituted. Both types require the same minimum amount and maximum spacing of transverse reinforcement throughout the member.
2. The shear strength of joints is limited and special provisions for anchoring bars in joints exist for special moment frames but not intermediate frames. Both frames require transverse reinforcement in joints although less is required for the intermediate frame.
3. Closely spaced transverse reinforcement is required in regions of potential hinging (typically the ends of beams and columns) to control lateral buckling of longitudinal bars after the cover has spalled. The spacing limit is slightly more stringent for columns in the special frame.
4. The amount of transverse reinforcement in regions of hinging for special frames is empirically tied to the concept of providing enough confinement of the concrete core to preserve a ductile response.

These amounts are not required in the intermediate frame and, in fact, for beams stirrups may be used in lieu of hoops.

5. The special frame must follow the strong column/weak beam rule. Although this is not required for the intermediate frame, it is highly recommended for multistory construction.
6. The maximum and minimum amounts of reinforcement are limited to prevent rebar congestion and to assure a nonbrittle flexural response. Although the precise limits are different for the two types of frames, a great portion of practical, buildable designs will satisfy both.
7. Minimum amounts of continuous reinforcement to account for moment reversals are required by placing lower limits on the flexural strength at any cross section. Requirements for the two types of frames are similar.
8. Locations for splices of reinforcement are more tightly controlled for the special frame.
9. In addition, the special frame must satisfy numerous other requirements beyond the intermediate frame to assure that member proportions are within the scope of the present research experience on seismic resistance and that analysis, design procedures, qualities of the materials, and inspection procedures are at the highest level of the state of the art.

9.5 SEISMIC DESIGN CATEGORIES D, E, AND F

The requirements conform to current practice in the areas of highest seismic hazard.

9.6 ACCEPTANCE CRITERIA FOR SPECIAL PRECAST STRUCTURAL WALLS BASED ON VALIDATION TESTING

9.6.1. Notation

Symbols additional to those in Chapter 21 of ACI 318 are defined:

A_h = area of hysteresis loop

E_1, E_2 = peak lateral resistance for positive and negative loading, respectively, for third cycle of loading sequence.

f_l = live load factor defined in 9.6.2.3.

h_w = height of column of test module, in. or mm.

K, K' = initial stiffness for positive and negative loading, respectively, for first cycle

θ_1, θ_2 = drift ratios at peak lateral resistance for positive and negative loading, respectively, for third cycle of loading sequence..

θ_1', θ_2' = drift ratios for zero lateral load for unloading at stiffness K, K' from peak positive and negative lateral resistance, respectively, for third cycle of loading sequence. (Figure C9.6.2.4)

Δ = lateral displacement, in. or mm. See Figures. C9.6.2.2.1, C9.6.2.2.2 and C9.6.2.2.3

Δ_a = allowable story drift, in. or mm. See Table 9.5.2.8 of SEI/ASCE 7-02

9.6.2 Definitions

9.6.2.1 Coupling elements. Coupling elements are connections provided at specific intervals along the vertical boundaries of adjacent structural walls. Coupled structural walls are stiffer and stronger than the same walls acting independently. For cast-in-place construction effective coupling elements are typically coupling beams having small span-to-depth ratios. The inelastic behavior of such beams is normally controlled by their shear strength. For precast construction, effective coupling elements can be precast beams connected to the adjacent structural walls either by post-tensioning, ductile mechanical devices, or grouted-in-place reinforcing bars. The resultant coupled construction can be either emulative of cast-in-

place construction or non-emulative(jointed). However, for precast construction coupling beams can also be omitted and mechanical devices used to connect directly the vertical boundaries of adjacent structural walls^{2,3}.

9.6.2.2 Drift ratio. The definition of the drift ratio, θ , is illustrated in Figure C9.6.2.2.1 for a three panel wall module. The position of the module at the start of testing, with only its self-weight acting, is indicated by broken lines. The module is set on a horizontal foundation support that is centered at A and is acted on by a lateral force H applied at the top of the wall. The self-weight of the wall is distributed uniformly to the foundation support. However, under lateral loading, that self-weight and any axial gravity load acting at the top of the wall cause overturning moments on the wall that are additional to the overturning moment Hh_w and can affect deformations. The chord AB of the centroidal axis of the wall is the vertical reference line for drift measurements.

For acceptance testing a lateral force H is applied to the wall through the pin at B. Depending on the geometric and reinforcement characteristics of the module that force can result in the module taking up any one, or a combination, of the deformed shapes indicated by solid lines in Figures C9.6.2.2.1, C9.6.2.2.2 and C9.6.2.2.3.

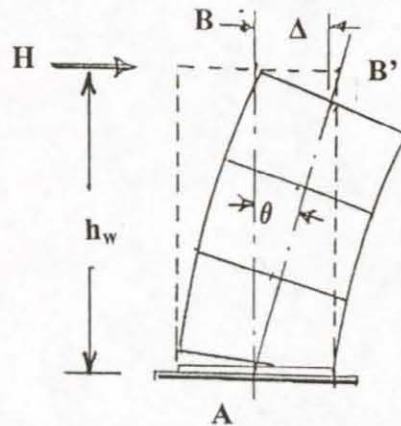

Fig. C9.6.2.2.1 Definition of drift ratio θ .

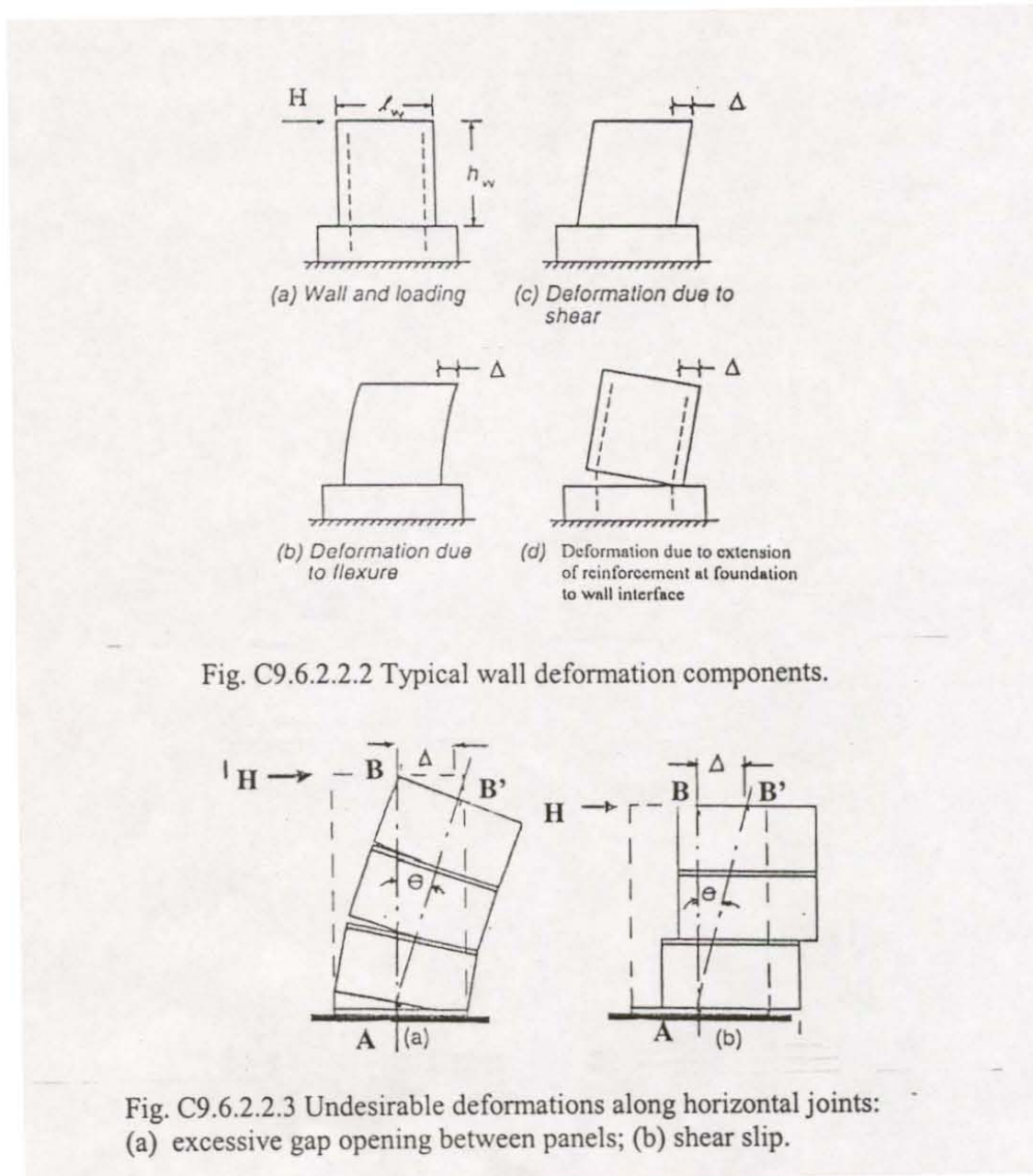

Fig. C9.6.2.2.2 Typical wall deformation components.

Fig. C9.6.2.2.3 Undesirable deformations along horizontal joints:
(a) excessive gap opening between panels; (b) shear slip.

Figure C9.6.2.2.2 illustrates several possible components of the displacement Δ for a wall that is effectively solid while Figure C9.6.2.2.3 illustrates two possibly undesirable components of the displacement Δ . Regardless of the mode of deformation of the wall, the lateral force causes the wall at B to displace horizontally by an amount Δ . The drift ratio is the angular rotation of the wall chord with respect to the vertical and for the setup shown equals Δ / h_w where h_w is the wall height and is equal to the distance between the foundation support at A and the load point at B.

Where prestressing steel is used in wall members, the stress f_{ps} in the reinforcement at the nominal and the probable lateral resistance shall be calculated in accordance with Sec. 18.7 of ACI 318.

9.6.2.3 Global toughness. These provisions describe acceptance criteria for special precast structural walls based on validation testing. The requirements of Sec. 21.2.1.5 of ACI 318 concerning toughness cover both to the energy dissipation of the wall system which, for monolithic construction, is affected primarily by local plastic hinging behavior and the toughness of the prototype structure as a whole. The

latter is termed “global toughness” in these provisions and is a condition that does not apply to the walls alone. That global toughness requirement can be satisfied only through analysis of the performance of the prototype structure as a whole when the walls perform to the criteria specified in these provisions.

The required gravity load for global toughness evaluations is the value given by these provisions. For conformity with Sec. 9.2.1 of ACI 318, UBC 1997, IBC 2003 and NFPA 5000, the required gravity load is $1.2D + f_l L$ where the seismic force is additive to gravity forces and $0.9D$ where the seismic force counteracts gravity forces. D is the effect of dead loads, L is the effect of live loads, and f_l is a factor equal to 0.5 except for garages, areas occupied as places of public assembly, and all areas where the live load is greater than 100 psf (4.79 kN/m²) where f_l equals 1.0.

9.6.2.5 Relative energy dissipation ratio. This concept is illustrated in Figure C9.6.2.5 for the third loading cycle to the limiting drift ratio required by Sec. 9.6.7.4, 9.6.7.5 or 9.6.7.6, as appropriate.

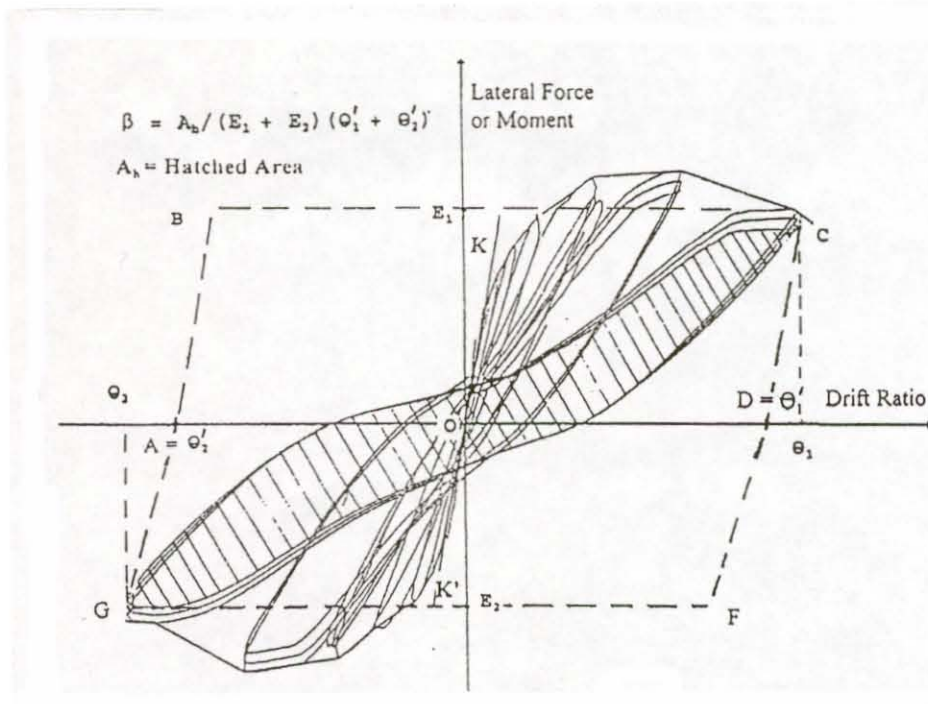

Fig. C9.6.2.5 Relative energy dissipation ratio.

For Figure C9.6.2.5, it is assumed that the test module has exhibited different initial stiffnesses, K and K' , for positive and negative lateral forces and that the peak lateral resistances for the third cycle for the positive and negative loading directions, E_1 and E_2 , also differ. The area of the hysteresis loop for the third cycle, A_h , is hatched. The circumscribing figure consists of two parallelograms, ABCD and DFGA. The slopes of the lines AB and DC are the same as the initial stiffness, K , for positive loading and the slopes of the lines DF and GA are the same as the initial stiffness, K' , for negative loading. The relative energy dissipation ratio concept is similar to the equivalent viscous damping concept used in Sec. 13.9.3 of the 2000 NEHRP Provisions and Commentary for required tests of seismic isolation systems.

For a given cycle the relative energy dissipation ratio, β , is the area, A_h , inside the lateral force-drift ratio loop for the module, divided by the area of the effective circumscribing parallelograms ABCD and DFGA. The areas of the parallelograms equal the sum of the absolute values of the lateral force strengths, E_1 and E_2 , at the drift ratios θ_1 and θ_2 multiplied by the sum of the absolute values for the drift ratios θ_1' and θ_2' .

9.6.3 Scope and general requirements. While only ACI Committee 318 can determine the requirements necessary for precast walls to meet the provisions of Sec. 21.2.1.5 of ACI 318, Sec. 1.4 of

ACI 318 already permits the building official to accept wall systems, other than those explicitly covered by Chapter 21 of ACI 318, provided specific tests, load factors, deflection limits, construction procedures and other pertinent requirements have been established for acceptance of such systems consistent with the intent of the code. The purpose of these provisions is to provide a framework that establishes the specific tests, load factors, deflection limits and other pertinent requirements appropriate for acceptance, for regions of high seismic risk or for structures assigned to high seismic performance or design categories, of precast wall systems, including coupled wall systems, not satisfying all the requirements of Chapter 21 of ACI 318. For regions of moderate seismic risk or for structures assigned to intermediate seismic performance or design categories, less stringent provisions than those specified here are appropriate.

These provisions assume that the precast wall system to be tested has details differing from those prescribed by Sec. 21.7 of ACI 318 for conventional monolithic reinforced concrete construction. Such walls may, for example, involve the use of precast elements, precast prestressed elements, post-tensioned reinforcement, or combinations of those elements and reinforcement.

For monolithic reinforced concrete walls a fundamental design requirement of Chapter 21 of ACI 318 is that walls with h_w/l_w exceeding 1.0 be proportioned so that their inelastic response is dominated by flexural action on a critical section located near the base of the wall. That fundamental requirement is retained in these provisions. The reason is that tests on modules, as envisioned in these provisions, cannot be extrapolated with confidence to the performance of panelized walls of proportions differing from those tested for the development of Chapter 21 of ACI 318 if the shear-slip displacement pattern of Figure C9.6.2.2.3, or the shear deformation response of Figure C9.6.2.2.2, governs the response developed in the test on the module. Two other fundamental requirements of Chapter 21 of ACI 318 are for ties around heavily strained boundary element reinforcement and the provision of minimum amounts of uniformly distributed horizontal and vertical reinforcement in the web of the wall. Ties around boundary element reinforcement to inhibit its buckling in compression are required where the strain in the extreme compression fiber is expected to exceed some critical value. Minimum amounts of uniformly distributed horizontal and vertical reinforcement over the height and length of the wall are required to restrain the opening of inclined cracks and allow the development of the drift ratios specified in Sec. 9.6.7.4, 9.6.7.5 and 9.6.7.6. Deviations from those tie and distributed reinforcement requirements are possible only if a theory is developed that can substantiate reasons for such deviations and that theory is tested as part of the validation testing.

9.6.3.1. These provisions are not intended for use with existing construction or for use with walls that are designed to conform to all the requirements of Sec. 21.7 of ACI 318. The criteria of these provisions are more stringent than those for walls designed to Sec. 21.7 of ACI 318. Some walls designed to 21.7, and having low height to length ratios, may not meet the drift ratio limits of Eq. 9.6.1 because their behavior may be governed by shear deformations. The height to length ratio of 0.5 is the least value for which Eq. 9.6.1 is applicable.

9.6.3.3. For acceptance, the results of the tests on each module must satisfy the acceptance criteria of Sec. 9.6.9. In particular, the relative energy dissipation ratio calculated from the measured results for the third cycle between the specified limiting drift ratios must equal or exceed 1/8. For uncoupled walls, relative energy dissipation ratios increase as the drift ratio increases. Tests on slender monolithic walls have shown relative energy dissipation ratios, derived from rotations at the base of the wall, of about 40-45 percent at large drifts. The same result has been reported even where there has been a significant opening in the web of the wall on the compression side. For 0.020 drift ratios and walls with height to length ratios of 4, relative energy dissipation ratios have been computed as 30, 18, 12, and 6 percent, for monolithic reinforced concrete, hybrid reinforced/post-tensioned prestressed concrete with equal flexural strengths provided by the prestressed and deformed bar reinforcement, hybrid reinforced/post-tensioned prestressed concrete with 25 percent of the flexural strength provided by deformed bar reinforcement and 75 percent by the prestressed reinforcement, and post-tensioned prestressed concrete special structural walls, respectively. Thus, for slender precast uncoupled walls of emulative or non-emulative design it is to be anticipated that at least 35 percent of the flexural capacity at the base of the wall needs to be

provided by deformed bar reinforcement if the requirement of a relative energy dissipation ratio of 1/8 is to be achieved. However, if more than about 40 percent of the flexural capacity at the base of the wall is provided by deformed bar reinforcement, then the self-centering capability of the wall following a major event is lost and that is one of the prime advantages gained with the use of post-tensioning. For squat walls with height to length ratios between 0.35 and 0.69 the relative energy dissipation has been reported¹³ as remaining constant at 23 percent for drifts between that for first diagonal cracking and that for a post-peak capacity of 80 percent of the peak capacity. Thus, regardless of whether the behavior of a wall is controlled by shear or flexural deformations a minimum relative energy dissipation ratio of 1/8 is a realistic requirement.

For coupled wall systems, theoretical studies and tests have demonstrated that the 1/8 relative energy dissipation ratio can be achieved by using central post-tensioning only in the walls and appropriate energy dissipating coupling devices connecting adjacent vertical wall boundaries.

9.6.3.3.4. The SEI/ASCE 7-02 allowable story drift limits are the basis for the drift limits of IBC 2003 and NFPA 5000. Allowable story drifts, Δ_a , are specified in Table 1617.3 of IBC 2003 and likely values are discussed in the Commentary to Sec. 9.6.7.4. The limiting initial drift ratio consistent with Δ_a equals $\Delta_d/\phi C_d h_w$, where ϕ is the strength reduction factor appropriate to the condition, flexure or shear, that controls the design of the test module. For example, for Δ_d/h_w equal to 0.015, the required deflection amplification factor C_d of 5, and ϕ equal to 0.9, the limiting initial drift ratio, corresponding to B in Figure C9.6.9.1, is 0.0033. The use of a ϕ value is necessary because the allowable story drifts of the IBC are for the design seismic load effect, E , while the limiting initial drift ratio is at the nominal strength, E_n , which must be greater than E/ϕ . The load-deformation relationship of a wall becomes significantly non-linear before the applied load reaches E_n . While the load at which that non-linearity becomes marked depends on the structural characteristics of the wall, the response of most walls remains linear up to about 75 percent of E_n .

9.6.3.3.5. The criteria of Sec. 9.6.9 are for the test module. In contrast, the criterion of Sec. 9.6.3.3.5 is for the structural system as a whole and can be satisfied only by the philosophy used for the design and analysis of the building as a whole. The criterion adopted here is similar to that described in the last paragraph of R21.2.1 of ACI 318 and the intent is that test results and analyses demonstrate that the structure, after cycling three times through both positive and negative values of the limiting drift ratio specified in Sec. 9.6.7.4, 9.6.7.5 or 9.6.7.6, as appropriate, is still capable of supporting the gravity load specified as acting on it during the earthquake.

9.6.4 Design procedure

9.6.4.1. The test program specified in these provisions is intended to verify an existing design procedure for precast structural walls for a specific structure or for prequalifying a generic type of special precast wall system for construction in general. The test program is not for the purpose of creating basic information on the strength and deformation properties of such systems for design purposes. Thus, the test modules should not fail during the validation testing, a result that is the opposite of what is usually necessary during testing in the development phase for a new or revised design procedure. For a generic precast wall system to be accepted based on these provisions, a rational design procedure is to have been developed prior to this validation testing. The design procedure is to be based on a rational consideration of material properties and force transfer mechanisms, and its development will usually require preliminary and possibly extensive physical testing that is not part of the validation testing. Because special wall systems are likely to respond inelastically during design-level ground shaking, the design procedure must consider wall configuration, equilibrium of forces, compatibility of deformations, the magnitudes of the lateral drifts, reversed cyclic displacements, the relative values of each limiting engineering design criteria (shear, flexure and axial load) and use appropriate constitutive laws for materials that include considerations of effects of cracking, loading reversals and inelasticity.

The effective initial stiffness of the structural walls is important for calculating the fundamental period of the prototype structure. The procedure used to determine the effective initial stiffness of the walls is to be

verified from the validation test results as described in Sec. 9.6.7.11.

Provisions Sec. 9.6.4.1.1 through 9.6.4.1.3 state the minimum procedures to be specified in the design procedure prior to the start of testing. The Authority Having Jurisdiction may require that more details be provided in the design procedure than those of Sec. 9.6.4.1.1 through 9.6.4.1.3 prior to the start of testing.

9.6.4.2. The justification for the small number of test modules, specified in Sec. 9.6.5.1 is that a previously developed rational design procedure is being validated by the test results. Thus, the test modules for the experimental program must be designed using the procedure intended for the prototype wall system and strengths must be predicted for the test modules before the validation testing is started.

9.6.5 Test modules.

9.6.5.1. One module must be tested for each limiting engineering design criterion, such as shear, or axial load and flexure, for each characteristic configuration of walls. Thus, in accordance with 9.6.4.3 if the test on the module results in a maximum shear stress of $3 \sqrt{f_c'}$ then the maximum shear stress that can be used in the prototype is that same value. Each characteristic in-plane configuration of walls, or coupled walls, in the prototype structure must also be tested. Thus, as a minimum for one-way structural walls, two modules with the configuration shown in Figure C9.6.2.2.1, and, for one way coupled walls, two modules with the configuration shown in either Figure C9.6.5.1(a) or in Figure C9.6.5.1(b), must be tested. In addition, if intersecting wall systems are to be used then the response of the wall systems for the two orthogonal directions needs to be tested. For two-way wall systems and coupled wall-frame systems, testing of configurations other than those shown in Figures C9.6.2.2.1 and C9.6.5.1 may be appropriate when it is difficult to realistically model the likely dominant earthquake deformations using orthogonal direction testing only.

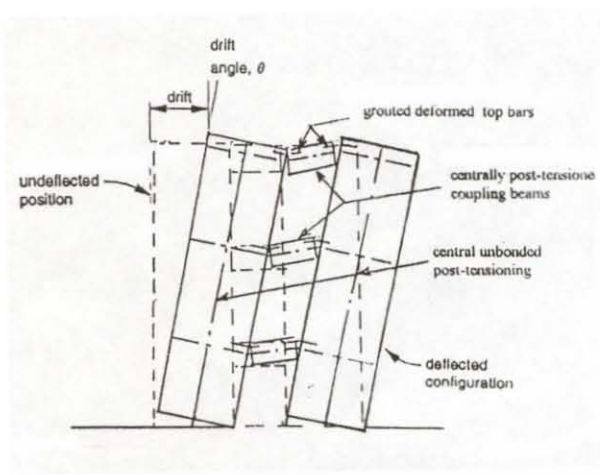

Fig. C9.6.5.1(a) Coupled wall test module with coupling beams.

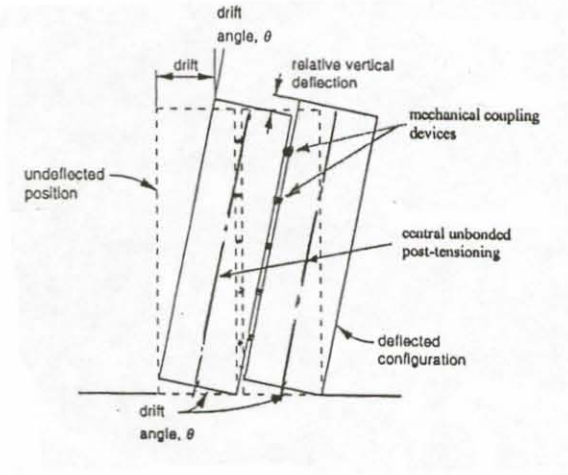

Fig. C9.6.5.1(b) Coupled wall test module with vertical mechanical couplers.

This provision should not be interpreted as implying that only two tests will need to be made to qualify a generic system. During the development of that system it is likely that several more tests will have been made, resulting in progressive refinements of the mathematical model used to describe the likely performance of the generic structural wall system and its construction details. Consequently, only one test of each module type for each limiting engineering design condition, at a specified minimum scale and subjected to specific loading actions, may be required to validate the system. Further, as stated in Sec. 9.6.9.1, if any one of those modules for the generic wall system fails to pass the validation testing

required by these provisions, then the generic wall system has failed the validation testing

In most prototype structures, a slab is usually attached to the wall and, as demonstrated by the results of the PRESS building test, the manner in which the slab is connected to the wall needs to be carefully considered. The connection needs to be adequate to allow the development of story drifts equal to those anticipated in these provisions. However, in conformity with common practice for the sub-assembly tests used to develop the provisions of Chapter 21 of ACI 318, there is no requirement for a slab to be attached to the wall of the test module. The effect of the presence of the slab should be examined in the development program that precedes the validation testing.

9.6.5.3. Test modules need not be as large as the corresponding walls in the prototype structure. The scale of the test modules, however, must be large enough to capture all the complexities associated with the materials of the prototype wall, its geometry and reinforcing details, load transfer mechanisms, and joint locations. For modules involving the use of precast elements, for example, scale effects for load transfer through mechanical connections should be of particular concern. The issue of the scale necessary to capture fully the effects of details on the behavior of the prototype should be examined in the development program that precedes the validation testing.

9.6.5.4. It is to be expected that for a given generic precast wall structure, such as an unbonded centrally post-tensioned wall constructed using multiple precast or precast pretensioned concrete wall panels, validation testing programs will initially use specific values for the specified strength of the concrete and reinforcement in the walls, the layout of the connections between panels, the location of the post-tensioning, the location of the panel joints, and the design stresses in the wall. Pending the development of an industry standard for the design of such walls, similar to the standard for special hybrid moment frames, specified concrete strengths, connection layouts, post-tensioning amounts and locations, etc., used for such walls will need to be limited to the values and layouts used in the validation testing programs.

9.6.5.5. For walls constructed using precast or precast/prestressed panels and designed using non-emulative methods, the response under lateral load can change significantly with joint opening (Figure C9.6.2.2.2(d) and Figure C9.6.2.2.3(a)). The number of panels used to construct a wall depends on wall height and design philosophy. If, in the prototype structure, there is a possibility of horizontal joint opening under lateral loading at a location other than the base of the wall, then the consequences of that possibility need to be considered in the development and validation test programs. Joint opening at locations other than the base can be prevented through the use of capacity design procedures.

9.6.5.6. The significance of the magnitude of the gravity load that acts simultaneously with the lateral load needs to be addressed during the validation testing if the development program suggests that effect is significant.

9.6.5.7. Details of the connection of walls to the foundation are critical, particularly for non-emulative wall designs. The deformations that occur at the base of the wall due to plastic hinging or extension of the reinforcing bars or post-tensioning steel crossing the wall to foundation interface, (Figure C9.6.2.2.2(d)), are in part determined by details of the anchorage and the bonding of those reinforcements on either side of the interface. Grout will be normally used to bed panels on the foundation and the characteristics of that grout in terms of materials, strength and thickness, can have a large effect on wall performance. The typical grout pad with a thickness of 1 inch (25 mm) or less can be expected to provide a coefficient of friction of about 0.6 under reversed loadings. Pads with greater thickness and without fiber reinforcement exhibit lesser coefficients of friction. Adequate frictional resistance is essential to preventing undesirable shear-slip deformations of the type shown in Figure C9.6.2.2.3(b).

9.6.5.8. The geometry of the foundations need not duplicate that used in the prototype structure. However, the geometric characteristics of the foundations (width, depth and length) need to be large enough that they do not influence the behavior of the test module.

9.6.6 Testing agency. In accordance with the spirit of the requirements of Sec. 1.3.5 and 1.4 of ACI 318, it is important that testing be carried out by a recognized independent testing agency, approved by the

agency having jurisdiction and that the testing and reporting be supervised by a registered design professional familiar with the proposed design procedure and experienced in testing and seismic structural design.

9.6.7 Test method. The test sequence is expressed in terms of drift ratio, and the initial ratio is related to the likely range of linear elastic response for the module. That approach, rather than testing at specific drift ratios of 0.005, 0.010, etc., is specified because, for modules involving prestressed concrete, the likely range of elastic behavior varies with the prestress level.

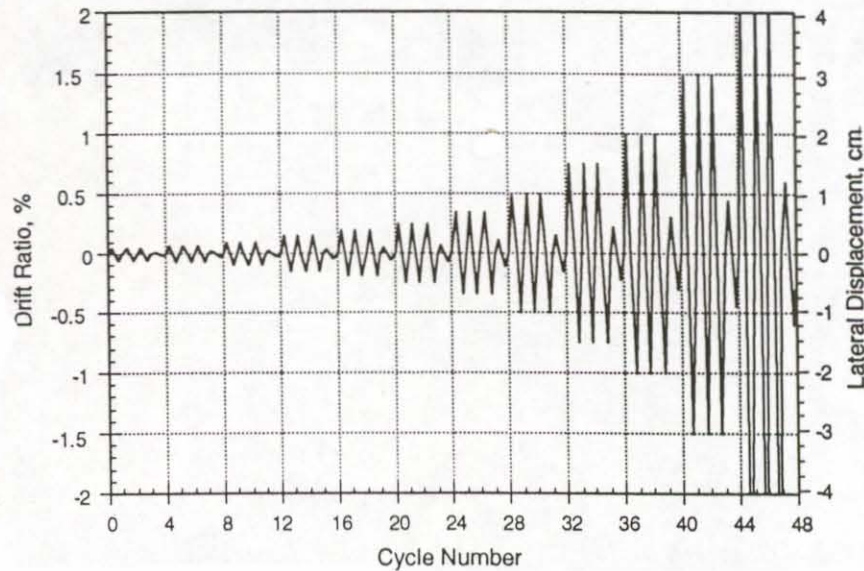

Fig. C9.6.7 Example of specified test sequence.

An example of the test sequence specified in Sec. 9.6.7.2 through 9.6.7.6 is illustrated in Figure C9.6.7. The sequence is intended to ensure that displacements are increased gradually in steps that are neither too large nor too small. If steps are too large, the drift capacity of the system may not be determined with sufficient accuracy. If the steps are too small, the system may be unrealistically softened by loading repetitions, resulting in artificially low maximum lateral resistances and artificially high maximum drifts. Also, when steps are too small, the rate of change of energy stored in the system may be too small compared with the change occurring during a major event. Results, using such small steps, can mask undesirable brittle failure modes that might occur in the inelastic response range during a major event. Because significant diagonal cracking is to be expected in the inelastic range in the web of walls, and in particular in squat walls, the pattern of increasing drifts used in the test sequence can markedly affect diagonal crack response in the post-peak range of behavior.

The drift capacity of a building in a major event is not a single quantity, but depends on how that event shakes the structure. In the forward near field, a single pulse may determine the maximum drift demand, in which case a single large drift demand cycle for the test module would give the best estimation of the drift capacity. More often, however, many small cycles precede the main shock and that is the scenario represented by the specified loading.

There is no requirement for an axial load to be applied to the wall simultaneously with the application of the lateral displacements. In many cases it will be conservative not to apply axial load because, in general, the shear capacity of the wall and the resistance to slip at the base of the wall increase as the axial load on the wall increases. However, as the height of the wall increases and the limiting drift utilized in the design of the wall increases, the likelihood of extreme fiber crushing in compression at maximum drift increases, and the importance of the level of axial load increases. The significance of the level of

axial loading should be examined during the development phase.

9.6.7.4. For the response of a structure to the design seismic shear force, current building codes such as UBC-97, IBC 2003 or NFPA 5000, or recommended provisions such as 2000 *Provisions*, SEI/ASCE 7-02 and FEMA 273 specify a maximum allowable drift. However, structures designed to meet that drift limit may experience greater drifts during an earthquake equal to the design basis earthquake and are likely to experience greater drifts during an earthquake equal to the maximum credible earthquake. In addition to the characteristics of the ground motion, actual drifts will depend on the strength of the structure, its initial elastic stiffness, and the ductility expected for the given lateral load resisting system. Specification of suitable limiting drifts for the test modules requires interpretation and allowance for uncertainties in the assumed ground motions and structural properties.

In IBC 2003, the design seismic shear force applied at the base of a building is related directly to its weight and the design elastic response acceleration, and inversely to a response modification factor, R . That R factor increases with the expected ductility of the lateral force resisting system of the building. Special structural walls satisfying the requirements of Sec. 21.2 and 21.7 are assigned an R value of 6 when used in a building frame system and a value of 5 when used in a bearing wall system. They are also assigned allowable story drift ratios that are dependent on the hazard to which the building is exposed. When the design seismic shear force is applied to a building, the building responds inelastically and the resultant computed drifts, (the design story drifts), must be less than a specified allowable drift. Additional guidance is given in FEMA 356 where the deformations for rectangular walls with height to length ratios greater than 2.5, and flanged wall sections with height to length ratios greater than 3.5, are to be assumed to be controlled by flexural actions. When structural walls are part of a building representing a substantial hazard to human life in the event of a failure, the allowable story drift ratio for shear controlled walls is 0.0075 and for flexure controlled walls is a function of the plastic hinge rotation at the base of the wall. For flexure controlled walls values range up to a maximum of about 0.02 for walls with confined boundary elements with low reinforcement ratios and shear stress less than $3\sqrt{f'_c}$

To compensate for the use of the R value, IBC Sec. 1617.4.6 requires that the drift determined by an elastic analysis for the code-prescribed seismic forces be multiplied by a deflection amplification factor, C_d , to determine the design story drift and that the design story drift must be less than the allowable story drift. In building frame systems, structural walls satisfying the requirements of Sec. 21.7 of ACI 318 are assigned a C_d value of 5. However, research⁸ has found that design story drift ratios determined in the foregoing manner may be too low. Drift ratios of 6 times IBC-calculated values, (rather than 5), are more representative of the upper bounds to expected drift ratios. The value of 6 is also in agreement with the finding that the drift ratio of an inelastic structure is approximately the same as that of an elastic structure with the same initial period. For flexure controlled walls the value of 6/5 times the present IBC limits on calculated drift ratio, would lead to a limit on real drift ratios of up to 0.024.

Duffy et al. reviewed experimental data for shear walls to define post-peak behavior and limiting drift ratios for walls with height to length ratios between 0.25 and 3.5. Seo et al. re-analyzed the data of Duffy et al. together with data from tests conducted subsequent to the analysis of Duffy et al. Duffy et al. established that for squat walls with web reinforcement satisfying ACI 318-02 requirements and height to length ratios between 0.25 and 1.1, there was a significant range of behavior for which drifts were still reliable in the post-peak response region. Typically the post-peak drift increased by 0.005 for a 20 percent degradation in capacity under cyclic loading. For greater values of degradation, drifts were less reliable. That finding has also been confirmed through tests conducted by Hidalgo et al.¹³ on squat walls with effective height to length ratios ranging between 0.35 and 1.0. Values of the drift ratio of the walls at inclined cracking and at peak capacity varied little with web reinforcement. By contrast, drifts in the post-peak range were reliable to a capacity equal to 80 percent of the peak capacity and were 0.005 greater than the drifts at peak capacity provided the walls contained horizontal and vertical web reinforcement equal to 0.25 percent.

From an analysis of the available test data, and from theoretical considerations for a wall rotating

flexurally about a plastic hinge at its base, Seo et al concluded that the limiting drift at peak capacity increased almost linearly with the height to length ratio of the wall. When the additional post peak drift capacity for walls with adequate web reinforcement was added to the drift at peak capacity, then the total available drift capacity in percent was given by the following equation:

$$1.0 \leq 0.67[h_w/l_w] + 0.5 \leq 3.0$$

where h_w is the height of the wall, and l_w is the length of the wall. The data from the tests of Hidalgo et al. suggest that while that formula is correct for squat walls the lower limit on drift can be decreased to 0.8 as specified in these provisions and that the use of that formula should be limited to walls with height to length ratios equal to or greater than 0.5. For wall height to length ratios less than 0.5 the behavior is controlled principally by shear deformations, (Figure C9.6.2.2.2(c)), and Eq. 9.6.1 should not be used. The upper value of 0.030 for the drift ratio was somewhat optimistic because the data were for walls with height to length ratios equal to or less than 3.5 and subsequent tests have shown that the upper limit of 2.5, as specified in Eq. 9.6.1, is a more realistic limit.

9.6.7.5. The design capacity for coupled wall systems must be developed by the drift ratio corresponding to that for the wall with the least h_w/l_w value. However, it is desirable that testing be continued to the drift given by Eq. 9.6.1 for the wall with the greatest h_w/l_w in order to assess the reserve capacity of the coupled wall system.

9.6.7.6. The drift limits of Eq. 9.6.1 are representative of the maximum that can be achieved by walls designed to ACI 318. The use of smaller drift limits is appropriate if the designer wishes to use performance measures less than the maximum permitted by ACI 318. Examples are the use of reduced shear stresses so that the likelihood of diagonal cracking of the wall is minimized or reduced compressive stresses in the boundary elements of the wall so that the risk of crushing is reduced. Non-linear time history analyses for the response to a suite of maximum considered earthquake (MCE) ground motions, rather than 1.5 times a suite of the corresponding design basis earthquake (DBE) ground motions, is required because the drifts for the response to the MCE motion can be significantly larger than 1.5 times the drifts for the response to the DBE motions.

9.6.7.10. In many cases, data additional to the minimum specified in Sec. 9.6.7.7 may be useful to confirm both design assumptions and satisfactory response. Such data include relative displacements, rotations, curvatures, and strains.

9.6.8 Test report.

The test report must be sufficiently complete and self-contained for a qualified expert to be satisfied that the tests have been designed and carried out in accordance with these criteria, and that the results satisfy the intent of these provisions. Sec.9.6.8.1.1 through 9.6.8.1.11 state the minimum evidence to be contained within the test report. The Authority having Jurisdiction or the registered design professional supervising the testing may require that additional test information be reported.

9.6.9 Test module acceptance criteria.

The requirements of this clause apply to each module of the test program and not to an average of the results of the program. Figure C9.6.9.1 illustrates the intent of this clause.

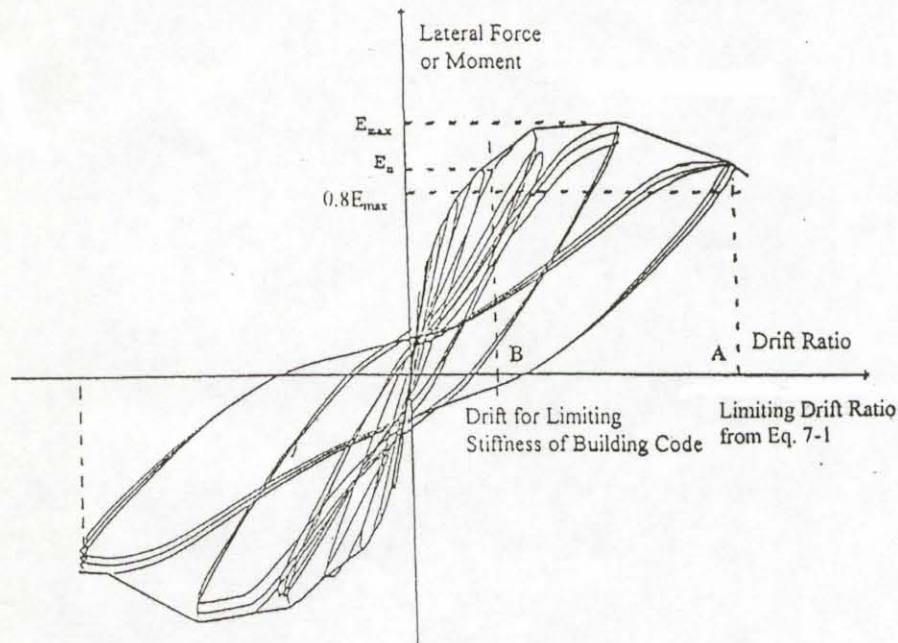

Fig. C9.6.9.1 Quantities used in evaluating acceptance criteria.

9.6.9.1.1. Where nominal strengths for opposite loading directions differ, as is likely for C-, L- or T-shaped walls, the criterion of Sec. 9.6.9.1.1 applies separately to each direction.

9.6.9.1.2. At high cyclic-drift ratios, strength degradation is inevitable. To limit the level of degradation so that drift ratio demands do not exceed anticipated levels, a maximum strength degradation of $0.20E_{max}$ is specified. Where strengths differ for opposite loading directions, this requirement applies independently to each direction.

9.6.9.1.3. If the relative energy dissipation ratio is less than $1/8$, there may be inadequate damping for the building as a whole. Oscillations may continue for some time after an earthquake, producing low-cycle fatigue effects, and displacements may become excessive.

If the stiffness becomes too small around zero drift ratio, the structure will be prone to large displacements for small lateral force changes following a major earthquake. A hysteresis loop for the third cycle between peak drift ratios of $1/10$ times the limiting drift ratio given by Eq. 9.6.1, that has the form shown in Figure C9.6.9.1, is acceptable. At zero drift ratio, the stiffnesses for positive and negative loading are about 11 percent of the initial stiffnesses. Those values satisfy Sec. 9.6.9.1.3. An unacceptable hysteresis loop form would be that shown in Figure C9.6.9.1.3 where the stiffness around zero drift ratio is unacceptably small for both positive and negative loading.

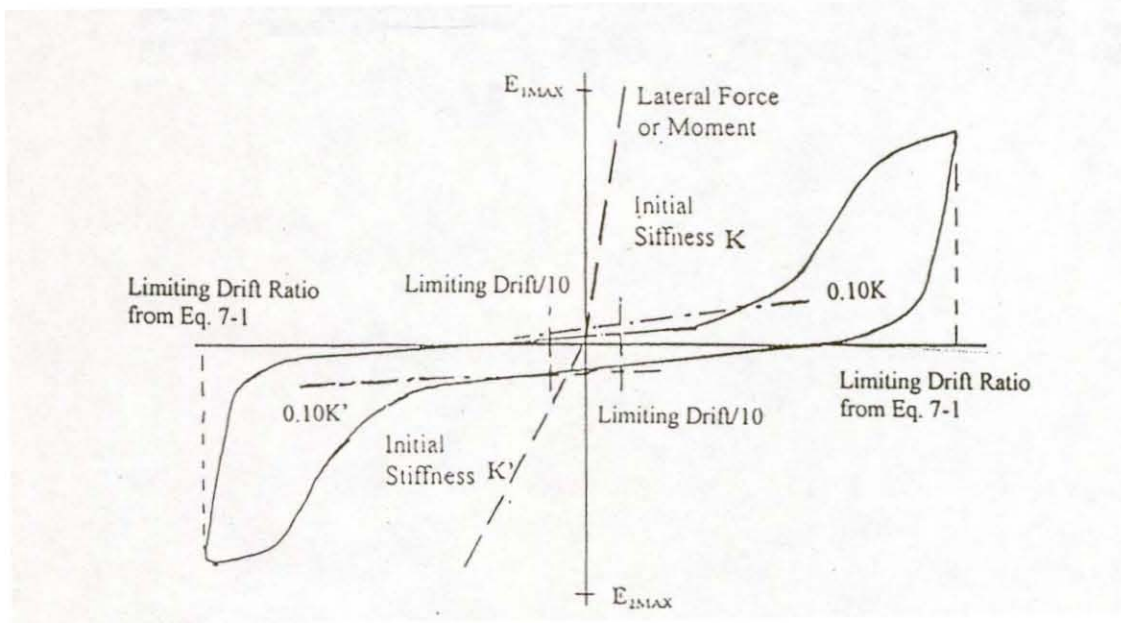

Figure C 9.6.9.1.3 Unacceptable hysteretic behavior

REFERENCES

- ACI Innovation Task Group I and Collaborators. 2001. Acceptance Criteria for Moment Frames Based on Structural Testing (T1.1-01) and Commentary(T1.1R-01). American Concrete Institute, Farmington Hills, MI, 2001, 10p.
- ACI Innovation Task Group I and Collaborators. 2001 "Special Hybrid Moment Frames Composed of Discretely Jointed Precast and Post-Tensioned Concrete Members (ACI T1.2-XX) and Commentary (ACI T1.2R-XX)," *ACI Structural Journal*, 98 (5):771-784.
- Ali, A. and J.K. Wight. 1990. Reinforced Concrete Structural Walls with Staggered Opening Configurations Under Reversed Cyclic Loading, Report UMCE 90-05, Department of Civil Engineering, University of Michigan, Ann Arbor, MI.
- Building Seismic Safety Council. 1987. *Guide to Use of NEHRP Recommended Provisions in Earthquake Resistant Design of Buildings*, 1985 Edition. Washington, D.C.: FEMA.
- Building Seismic Safety Council, *NEHRP Recommended Provisions for Seismic Regulations for New Buildings and Other Structures*, 2000. FEMA 368 and 369. Washington, D.C.
- Cheok, G. S., and H. S. Lew. 1991. "Performance of Precast Concrete Beam-to-Column Connections Subject to Cyclic Loading," *PCI Journal*, 36, (3):56-67.
- Duffy, T.A., A.Goldman, and C.R. Farrar. 1993. "Shear Wall Ultimate Drift Limits," Report NUREG/CR-6104, LA-12649-MS. U.S. Nuclear Regularity Commission.
- Elliott, K. S., G. Davies, and W. Omar. 1992. "Experimental and Theoretical Investigation of Precast Concrete Hollow-Cored Slabs Used as Horizontal Floor Diaphragms," *The Structural Engineer*, 70, (10):175-187.
- Englekirk, R. E. 1987. "Concepts for the Development of Earthquake Resistant Ductile Frames of Precast Concrete," *PCI Journal*, 32, (1).
- Federal Emergency Management Agency. 2000. NEHRP Guidelines for the Seismic Rehabilitation of

- Buildings, Chapter 6, Concrete, FEMA 356 and 357.
- French, C. W., M. Hafner, and V. Jayashanker. 1989. "Connections Between Precast Elements - Failure Within Connection Region," *ASCE Journal of Structural Engineering*, 115, (12):3171-3192.
- Hawkins, N. M., and R. E. Englekirk. 1987. "U.S.-Japan Seminar on P/C Concrete Construction in Seismic Zones," *PCI Journal*, 32,(2).
- Hidalgo, P.A.,C.A. Ledezma, and R.A. Jordan. 2002. "Seismic Behavior of Squat Reinforced Concrete Shear Walls," *Earthquake Spectra*, 18 (2): 287-308.
- Hutchinson, R.L., S.H. Rizkalla, M. Lau, and M. Heuvel, 1991. "Horizontal Post-Tensioned Connections for Precast Concrete Bearing Shear Walls," *PCI Journal*, 36,(3):.64-76.
- International Code Council. 2003. International Building Code, Falls Church, VA.
- International Conference of Building Officials, Uniform Building Code. 1997, Vol. 2, Structural Engineering Design Provisions. Whittier, CA.
- Ishizuka, T., and N. M. Hawkins. 1987. "Effect of Bond Deterioration on the Seismic Response of Reinforced and Partially Prestressed Concrete and Ductile Moment Resistant Frames," SM87-2, University of Washington, Department of Civil Engineering.
- Jayashanker, V., and C. E. French. 1988. "An Interior Moment Resistant Connection Between Precast Elements Subjected to Cyclic Lateral Loads," *Structural Engineering Report No. 87-10*, Minneapolis: University of Minnesota.
- Kurama, Y.C. 2002. "Hybrid Post-Tensioned Precast Concrete Walls for Use in Seismic Regions." *PCI Journal*, 47, (5): 36-59.
- Mast, R. F. 1992. "A Precast Concrete Frame System for Seismic Zone Four," *PCI Journal* 37(1):50-64.
- Nakaki, S. D., and R. E. Englekirk. 1991. "PRESSSS Industry Seismic Workshops: Concept Development," *PCI Journal* 36(5):54-61.
- National Fire Protection Association . 2003. Building Construction and Safety Code, NFPA 5000, Quincy, MA.
- Neille, D. S. 1977. "Behavior of Headed Stud Connections for Precast Concrete Connections for Precast Concrete Panels Under Monotonic and Cycled Shear Loading," thesis submitted in partial fulfillment of the requirements of Doctor of Philosophy, University of British Columbia.
- New Zealand Society for Earthquake Engineering. 1991. "Guidelines for the Use of Structural Precast Concrete in Buildings."
- Park, R., and K. J. Thompson. 1977. "Cyclic Load Tests on Prestressed and Partially Prestressed Beam-Column Joints," *PCI Journal* 22(5):84-110.
- PCI Ad Hoc Committee on Precast Walls. 1997. "Design for Lateral Force Resistance with Precast Concrete Shear Walls, *PCI Journal*, 42, (2): 44-65.
- Pekau, O. A., and D. Hum. 1991. "Seismic Response of Friction-Jointed Precast Panel Shear Walls," *PCI Journal* 36(2):56-71.
- Powell, G., F. Filippou, V. Prakash, and S. Campbell. 1993. "Analytical Platform for Precast Structural Systems," *In Proceedings, ASCE Structures Congress '93*. New York: ASCE.
- Priestley, M. J. N. 1991. "Overview of PRESSSS Research Program," *PCI Journal* 36(4):50-57.
- Priestley, M. J. N., and J. T. Tao. 1993. "Seismic Response of Precast Prestressed Concrete Frames with Partially Debonded Tendons," *PCI Journal* 38(1):58-69.
- Priestley, M.J.N., S. Sritharan, J. Conley, and S. Pampanin. 1999. "Preliminary Results and Conclusions

from the PRESSS Five-Story Precast Concrete Test Building,” *PCI Journal*, 44,(6): 42-67.

Schultz, A.E. and R.A. Magana. 1996. “Seismic Behavior of Connections in Precast Concrete Walls,” Paper SP 162-12. Mete A. Sozen Symposium, pp.273-311, ACI SP 162. American Concrete Institute, Farmington Hills, MI.

Seo, S-Y., L-H Lee, and N.M. Hawkins. 1998. “ The Limiting Drift and Energy Dissipation Ratio for Shear Walls Based on Structural Testing,” *Journal of the Korean Concrete Institute*,10, (6): 335-343.

Stanton, J. F., T. R. Hicks, and N. M. Hawkins. 1991. “PRESSS Project 1.3: Connection Classification and Evaluation,” *PCI Journal* 36(5):62-71.

Stanton, J.F. and S.D. Nakaki, 2002. “Design Guidelines for Precast Concrete Seismic Structural Systems-Unbonded Post-Tensioned Split Walls” PRESSS Report 01/03-09, UW Report SM 02-02, Department of Civil Engineering, University of Washington, Seattle, WA..

Taylor, C.P., P.E. Cote, and J.W. Wallace. “ Design of Slender Reinforced Concrete Walls with Openings,” *ACI Structural Journal*, 95, (4): 420-433.

Thompson, K. J., and R. Park. 1980. “Seismic Response of Partially Prestressed Concrete,” *ASCE Journal of the Structural Division*, 106(ST8):1755-1775.

Uang, C-M., and A. Maarouf.1993. “Seismic Displacement Amplification Factor in Uniform Building Code,” SEAONC Research Bulletin Board, BB93-3, pp. B1-B2, and “Displacement Amplification Factor for Seismic Design Provisions,” *Proc. Structures Congress*, ASCE, Vol.1, pp. 211-216. Irvine, CA

This page is intentionally left blank.

Appendix to Chapter 9

UNTOPPED PRECAST DIAPHRAGMS

Although not directly addressed in the code, untopped precast components have been used as diaphragms in high seismic regions. Untopped hollow-core planks with grouted joints and end chords have performed successfully both in earthquakes and in laboratory tests, (Elliot et al., 1992; Menegotto, 1994; Priestley et al., 1999). Experience has also demonstrated the unsuccessful use of cast-in-place concrete topping as diaphragms (Iverson and Hawkins, 1994). Where problems have occurred, they have not been inherently with the precast construction, but the result of a failure to address fundamental requirements of structural mechanics.

This section provides conditions that are intended to ensure that diaphragms composed of precast components are designed with attention to the principles required for satisfactory behavior. Each condition addresses requirements that should be considered for all diaphragms, but which are particularly important in jointed construction. Specific attention should be paid to providing a complete load path that considers force transfer across all joints and connections.

A9.2 DESIGN REQUIREMENTS

A9.2.1 Configuration. Out-of-plane offsets in the vertical elements of the seismic-force-resisting system place particularly high demands on the diaphragm in providing a continuous load path. Untopped precast diaphragms are not suitable for this condition. It must be recognized that the demand on diaphragms in buildings with these plan irregularities requires special attention. In accordance with Sec. 4.6.3.2 the design force for the diaphragm should be increased by at least 25 percent when such irregularities are present in structures assigned to Seismic Design Category D, E, or F.

A9.2.2 Diaphragm demand. Following the principle that the diaphragm is not generally an appropriate location for inelastic behavior and, in particular, for untopped precast diaphragms, specific direction is provided that elastic models should be used for diaphragm analysis. Connections are subject to a combination of load effects (Fleischman et al., 1998). The distribution of loads may change after yielding, and therefore the design of the diaphragm should avoid yielding.

Since the diaphragm is not generally an appropriate location for inelastic behavior, it should be designed to a level of strength that is intended to ensure that the ductility and yield strength of the seismic-force-resisting system can be mobilized before the diaphragm yields. While research (Fleischman et al., 1998) suggests that the diaphragm demand will not exceed twice the equivalent lateral forces used for the vertical system design, Table 4.3-1 prescribes an overstrength factor, Ω_o , and Sec. 4.3.3 prescribes a redundancy factor, ρ , for the systems that should be used. If an analysis of the probable strength of the seismic-force-resisting system is made to determine a lower demand on the diaphragm, the design force used should still be sufficient to attempt to ensure that the diaphragm remains elastic. For that reason a 1.25 factor is specified.

A9.2.3 Mechanical connections. Although the design procedures prescribed in these sections are intended to ensure elastic behavior at the level of the code design forces, it is recognized that catastrophic events may exceed code requirements. Under such circumstances, it is important that the connections possess ductility under reversed cyclic loading. The intent, in these sections, is for the connection capacity to be limited by steel yielding of the connector and not by brittle concrete failure or weld fracture.

Substantiating experimental evidence to demonstrate through testing and evaluation that mechanical connections satisfy the principles specified in ACI T1.1-01 and ATC-24, and can develop the required capacity and ductility, should meet the following criteria:

Test Procedures:

1. Prior to testing, a design procedure should have been developed for prototype connections having the generic form that is to be tested for acceptance.
2. That design procedure should be used to proportion the test specimens.
3. Specimens should not be less than two-thirds scale.
4. Test specimens should be subject to a sequence of reversing cycles having increasing limiting displacements.
5. Three fully reversed cycles should be applied at each limiting displacement.
6. The maximum load for the first sequence of three cycles should be 75 percent of the calculated nominal strength of the connection, E_n .
7. The stiffness of the connection should be defined as 75 percent of the calculated nominal strength of the connection divided by the corresponding measured displacement, δ_m .
8. Subsequent to the first sequence of three cycles, limiting displacements should be incremented by values not less than 1.0, and not more than 1.25 times δ_m .

Acceptance Criteria:

1. The connection should develop a strength, E_{max} , greater than its calculated nominal strength, E_n .
2. The strength, E_{max} , should be developed at a displacement not greater than $3\delta_m$.
3. For cycling between limiting displacements not less than $3\delta_m$, the peak force for the third loading cycle for a given loading direction should not be less than $0.8 E_{max}$ for the same loading direction.

Results of reversed cyclic loading tests on typical connections are reported in Spencer (1986) and Pincheira et al. (1998).

A9.2.4 Cast-in-place strips. Successful designs may include a combination of untopped precast components with areas of concrete topping in locations of high force demand or concentration. Such topping can allow for continuity of reinforcement across joints. For such designs, the requirements for topping slab diaphragms apply to the topped portions.

A9.2.5 Deformation compatibility. An important element in the *Provisions* is attention to deformation compatibility requirements. Reduction in effective shear and flexural stiffness for the diaphragm is appropriate in evaluating the overall effects of drift on elements that are not part of the seismic-force-resisting system. This approach should encourage the use of more vertical elements to achieve shorter spans in the diaphragm and result in improved system redundancy and diaphragm continuity. Redundancy will also improve the overall behavior should any part of the diaphragm yield in a catastrophic event.

REFERENCES

- Elliot, K. S., G. Davies, and W. Omar. 1992. "Experimental and Theoretical Investigation of Precast Concrete Hollow-cored Slabs Used as Horizontal Floor Diaphragms." *The Structural Engineer*, 70 (10) 175-187.
- Fleischman, R. B., R. Sause, S. Pessiki, and A. B. Rhodes. 1998. "Seismic Behavior of Precast Parking Structure Diaphragms." *PCI Journal*, 43 (1): 38-53.
- Iverson, J. K., and N. M. Hawkins. 1994. "Performance of Precast/Prestressed Concrete Building Structures During the Northridge Earthquake," *PCI Journal* 39(2): 38-55.
- Menegotto, M. 1994. "Seismic Diaphragm Behavior of Untopped Hollow-Core Floors," *Proceedings, F.I.P. Congress*, Washington, D.C.

Pincheira, J. A., M. G. Oliva, and F. I. Kusumo-Rahardjo. 1998. "Tests on Double Tee Flange Connectors Subject to Monotonic and Cyclic Loading," *PCI Journal*, 43 (3): 82-96.

Priestley, M. J. N., S. Sritharan, J. R. Conley, and S. Pampanin. 1999. "Preliminary Results and Conclusions from the PRESSS Five-Story Precast Concrete Test Building." *PCI Journal*, 44 (6).

Spencer, R. 1986. "Earthquake Resistant Connections for Low Rise Precast Concrete Buildings," *Proceedings, U.S.-Japan Seminar on Precast Concrete Construction in Seismic Zones*, Vol. 1, Japan Concrete Institute.

This page is intentionally left blank.

Chapter 10 Commentary

COMPOSITE STEEL AND CONCRETE STRUCTURE DESIGN REQUIREMENTS

10.1 GENERAL

The 1994 Edition of the *NEHRP Recommended Provisions* included a new chapter on composite steel and concrete structures. The requirements in that chapter have been updated and incorporated in Part II of the 1997 Edition of the *AISC Seismic Provisions*. This edition of the *NEHRP Recommended Provisions* includes by reference Part II of the *AISC Seismic Provisions (1997)* together with the underlying AISC-LRFD (1999) and ACI 318 (1999) standards. Part II of the *AISC Seismic Provisions* provides definitions for composite systems consistent with the system designations in Table 4.3-1 and specifies requirements for the seismic design of composite systems and components.

10.4 SEISMIC DESIGN CATEGORIES D, E, AND F

In general, available research shows that properly detailed composite elements and connections can perform as well as, or better than, structural steel and reinforced concrete components. However, due to the lack of design experience with certain types of composite structures in high seismic risk areas, usage of composite systems in Seismic Design Categories D and above requires documentation (substantiating evidence) that the proposed system will perform as intended by Part II of the *AISC Seismic Provisions* and as implied by the R values in Table 4.3-1. It is intended that the substantiating evidence consist of a rational analysis that considers force transfer between structural steel, reinforced concrete, and composite elements and identifies locations in the structure required to sustain inelastic deformations and dissipate seismic energy. Design of composite members and connections to sustain inelastic deformations must be based on models and criteria substantiated by test data. For many composite components, test data and design models are available and referenced in the commentary to the *AISC Seismic Provisions – Part II (1997)*.

This page is intentionally left blank.

Chapter 11 Commentary

MASONRY STRUCTURE DESIGN REQUIREMENTS

11.1.2 References. The main concern of Chapter 11 is the proper detailing of masonry construction for earthquake resistance. The bulk of the detailing requirements in this chapter are contained in ACI 530/ASCE 5/TMS 402. The commentary for ACI 530/ASCE 5/TMS 402 contains a valuable discussion of the rationale behind detailing requirements that is not repeated here.

11.2.1.5.1 Shear keys. Shear keys provide resistance to the movement of shear walls when yielding of the reinforcing steel occurs. This phenomenon was observed in tests by Klingner. (Leiva and Klingner 1991). There has been no field verification of shear wall movement under seismic events. The shear key requirements are based on judgment and sizes are based on current construction procedures.

11.2.2.3 Article 1.3 permits the use of structural clay wall-tile meeting the requirements of ASTM C 34. At the time of publication, it was felt that the existing detailing requirements for masonry elements did not adequately address the brittle nature of clay wall-tile units.

11.2.2.11 The nominal shear strength of coupling beams must be equal to the shear caused by development of a full yield hinge at each end of the coupling beams. This nominal shear strength is estimated by dividing the sum of the calculated yield moment capacity of each end of the coupling beams, M_1 and M_2 , by the clear span length, L .

A coupling beam may consist of a masonry beam and a part of the reinforced concrete floor system. Reinforcement in the floor system parallel to the coupling beam should be considered as a part of the coupling beam reinforcement. The limit of the minimum width of floor that should be used is six times the floor slab thickness. This quantity of reinforcement may exceed the limits of Sec. 3.2.3.5 but should be used for the computation of the normal shear strength.

11.2.2.12 The theory used for design of beams has a limited applicability to deep beams. Shear warping of the cross section and a combination of diagonal tension stress and flexural tension stress in the body of the deep beam requires that deep beam theory be used for design of members that exceed the specified limits of span to depth ratio. Analysis of wall sections that are used as beams generally will result in a distribution of tensile stress that requires the lower one-half of the beam section to have uniformly distributed reinforcement. The uniform distribution of reinforcement resists tensile stress caused by shear as well as flexural moment.

The flexural reinforcement for deep beams must meet or exceed the minimum flexural reinforcement ratio of Sec. 3.2.4.3.2. Additionally, horizontal and vertical reinforcement must be distributed throughout the length and depth of deep beams and must provide reinforcement ratios of at least $0.0007bd$. Distributed flexural reinforcement may be included in the calculations of the minimum distributed reinforcement ratios.

11.2.2.13 Corrugated sheet metal ties are prohibited from use in Seismic Design Categories E and F due to their decreased capacity in transferring loads.

11.2.2.14 Masonry pryout refers to a failure mode of a shear anchor in which the embedded end of the anchor moves opposite to the direction of applied shear, prying out a roughly semi-conical body of masonry (concrete, as applicable) behind the anchor. It is not the same as a "breakout," which refers to a failure mode of a shear anchor in which a body of masonry (or concrete, as applicable) is broken off between the anchor and a free edge, in the direction of applied shear.

11.4 GLASS-UNIT MASONRY AND MASONRY VENEER

Chapters 11 and 12 of ACI 530-95/ASCE 5-95/TMS 402-95 were introduced into the 1997 *Provisions* to address design of glass-unit masonry and masonry veneer. Direct reference is made to these chapters for design requirements. Investigations of seismic performance have shown that architectural components meeting these requirements perform well (Jalil, Kelm, and Klingner, 1992; and Klingner, 1994).

11.5 PRESTRESSED MASONRY

Allowable stress provisions are set forth in MSJC Chapter 4. There are no strength design provisions for prestressed masonry. There is a paucity of data on the cyclic testing of prestressed shear walls. There is only one published report of cyclic testing of prestressed shear walls in-plane using a testing protocol similar to the sequential phased displacement method used in the TCCMaR program. This report considers specimens both partially and fully grouted using only prestressed bar reinforcing. There is no published in-plane cyclic test data using prestressed strand, nor any published data using prestressed reinforcing in combination with mild steel reinforcing. There is some additional unpublished data on in-plane testing of prestressed masonry shear walls using prestressed bars only.

The data shows that solid grouted prestressed masonry shear walls subjected to in-plane cyclic displacements perform as an essentially elastic system with stiffness degradation in each cycle. Little energy is dissipated in the hysteresis loops. Although reasonably large displacements can be reached, there is essentially no ductile behavior. The data on partially grouted walls is sparse and shows inability to reach large displacement before failure. The data shows that MSJC Eq. 3-21 provides a reasonable estimate for the shear capacity for solid grouted walls.

The TCCMaR research showed that the ductility of a masonry wall loaded in-plane was highly dependent on the level of axial load and the amount of reinforcing. Ductile behavior declines significantly at axial loads in excess of 100 psi; ductile behavior also declines significantly when the reinforcement ratio is high. The addition of prestressing to a wall with mild steel reinforcing will decrease the ductility.

Because of the limited data and the potential for non-ductile, prestressed masonry shear walls are restricted to Seismic Design Categories A and B and the R factor is set at 1½. As more research becomes available, these restrictions could be eased.

11.6 ANCHORING TO MASONRY

This section covers cast-in-place headed anchor bolts and bent-bar anchors (J- or L-bolts) in grout. General background information on this topic is given in CEB, 1995.

The tensile capacity of a headed anchor bolt is governed by yield and fracture of the anchor steel or by breakout of a roughly conical volume of masonry starting at the anchor head and having a fracture surface oriented at 45 degrees to the masonry surface. Steel capacity is calculated using the effective tensile stress area of the anchor (that is, including the reduction in area of the anchor shank due to threads). Masonry breakout capacity is calculated using expressions adapted from concrete design, which use a simplified design model based on a stress of $4\sqrt{f'_m}$ uniformly distributed over the area of that right circular cone, projected onto the surface of the masonry. Reductions in breakout capacity due to nearby edges or adjacent anchors are computed in terms of reductions in those projected areas (Brown and Whitlock, 1983).

The tensile capacity of a bent-bar anchor bolt (J- or L-bolt) is governed by yield and fracture of the anchor steel, by tensile cone breakout of the masonry, or by straightening and pullout of the anchor from the masonry. Capacities corresponding to the first two failure modes are calculated as for headed anchor bolts. Pullout capacity is calculated as proposed by Shaikh (1996). Possible contributions to tensile pullout capacity due to friction are neglected.

The tensile breakout capacity of a headed anchor is usually much greater than the pullout capacity of a J- or L-bolt. The designer is encouraged to use headed anchors when anchor tensile capacity is critical.

The shear capacity of a headed or a bent-bar anchor bolt is governed by yield and fracture of the anchor steel or by masonry shear breakout. Steel capacity is calculated using the effective tensile stress area (that-is, threads are conservatively assumed to lie in the critical shear plane). Shear breakout capacity is calculated as proposed by Brown and Whitlock, 1983.

Under static shear loading, bent-bar anchor bolts (J- or L-bolts) do not exhibit straightening and pullout. Under reversed cyclic shear, however, available research suggests that straightening and pullout may occur. Headed anchor bolts are recommended for such applications (Malik et al., 1982).

REFERENCES

- Abboud, B. E., X. Lu, and F. C. Schmitt. 1993. "An Evaluation of Three Current Deflection Methods for Predicting the Lateral Deflection of Masonry Walls." In *Proceedings of the Sixth North American Masonry Conference*, Philadelphia, Pennsylvania, pp.73-85.
- Abboud, B. E., and A. A. Hamid. 1987. "A Comparative Study of the Flexural Behavior of Reinforced Block Masonry and Reinforced Concrete Using Small Scale Model Walls." In *Proceedings of the Fourth North American Masonry Conference*, Los Angeles, California.
- Abboud, B. E., A. A. Hamid, and H. G. Harris. 1990. "Small Scale Modeling of Concrete Block Masonry Structures," *ACI Structural Journal* 87(2):145-155.
- Abboud, B. E. 1987. *The Use of Small Scale Direct Models for Concrete Block Masonry Assemblages and Slender Reinforced Walls Under Out-of-Plane Loads*, Doctoral Thesis, Drexel University, Philadelphia, Pennsylvania.
- Blondet, J. M., R. L. Mayes, T. E. Kelley, R. R. Villablanca, and R. E. Klingner. 1989. *Performance of Engineered Masonry in the Chilean Earthquake of March 3, 1985: Implications for U.S. Design Practice*. Austin: Phil Ferguson Structural Engineering Laboratory, University of Texas.
- Brown, R. H., and A. R. Whitlock. 1983. "Strength of Anchor Bolts in Grouted Masonry," *ASCE Journal of Structural Engineering* 109(6).
- CEB. 1995. "Design of Fastenings in Concrete (Draft CEB Guide, Parts 1 to 3)" and "Fastenings for Seismic Retrofitting (State-of-the-Art Report on Design and Application)," Task Group 3.5 (Embedments), Euro-International Concrete Committee (CEB), *CEB Bulletin D'Information* 226. Comite Euro-International du Beton.
- Chen, S. W., P. A. Hidalgo, R. L. Mayes, R. W. Clough, and H. D. McNiven. 1978. *Cyclic Loading Tests of Masonry Single Piers*, Vol. 2, EERC Report UCB/EERC-78/27. Berkeley: University of California Earthquake Engineering Research Center.
- Fattal, S. G. 1993a. *Strength of Partially Grouted Masonry Shear Walls*, Report NIST 5147. Gaithersburg, Maryland: National Institute of Standards and Technology.
- Fattal, S. G. 1993b. *The Effect of Critical Parameters on the Behavior of Partially Grouted Masonry Shear Walls Under Lateral Loads*, NIST Report NISTIR 5116. Gaithersburg, Maryland: National Institute of Standards and Technology.
- Fattal, S. G., and D. R. Todd. 1991. *Ultimate Strength of Masonry walls: Prediction vs. Test Results*, NIST Report NISTIR 4633. Gaithersburg, Maryland: National Institute of Standards and Technology.
- Hamid, A. A., M. K. Hatem, H. G. Harris, and B. E. Abboud. 1990. "Hysteretic Response and Ductility of Reinforced Concrete Masonry Walls Under Out-of-Plane Loading." In *Proceedings of the Fifth North American Conference*, Urbana, Illinois, pp. 397-410.

- Hamid, A. A., B. E. Abboud, M. W. Farah, M. K. Hatem, and H. G. Harris. 1989. "Response of Reinforced Block Masonry Walls to Out-of-Plane Static Loads." In *U.S.-Japan Coordinated Program For Masonry Building Research*, Report 3.2(a). Drexel University.
- He, L., and N. Priestley. 1992. *Seismic Behavior of Flanged Masonry Shear Walls - Final Report*, TCCMaR Report 4.1-2.
- Hidalgo, P. A., R. L. Mayes, H. D. McNiven, and R. W. Clough. 1978. *Cyclic Loading Tests of Masonry Single Piers*, Vol. 1 and 3, EERC Report UCB/EERC-78/27 and 79/12. Berkeley, University of California Earthquake Engineering Research Center.
- Horton, R. T., and M. K. Tadros. 1990. "Deflection of Reinforced Masonry Members," *ACI Structural Journal* 87(4):73-85.
- Jail, I., W. Kelm, and R. E. Klingner. 1992. *Performance of Masonry and Masonry Veneer Buildings in the Loma Prieta Earthquake*, PMSEL Report 92-1. Austin: University of Texas, Department of Civil Engineering.
- Klingner, R. E. 1994. *Performance of Masonry Structures in the Northridge, California, Earthquake of January 17, 1991*. Boulder, Colorado: The Masonry Society.
- Leiva, G., and R. Klingner. 1991. *In-Plane Seismic Resistance of Two-story Concrete Masonry Shear Walls with Openings*, TCCMaR Report 3.1(c)-2.
- Limin, H., and N. Priestley. 1988. *Seismic Behavior of Flanged Masonry Shear Walls*, TCCMaR Report 4.1-1.
- Malik, J. B., J. A. Mendonca, and R. E. Klingner. 1982. "Effect of Reinforcing Details on the Shear Resistance of Short Anchor Bolts Under Reversed Cyclic Loading," *Journal of the American Concrete Institute, Proceedings*, 79, (1): 3-11.
- Matsumura, A. 1987. "Shear Strength of Reinforced Hollow Unit Masonry Walls." In *Proceedings of the 4th North American Masonry Conference*, Los Angeles, California.
- Mayes, R. L., Y. Omote, and R. W. Clough. 1976. *Cyclic Shear Tests of Masonry Piers*, Vol. 1, Report 76-8. Berkeley: University of California Earthquake Engineering Research Center.
- Merryman, K., G. Leiva, N. Antrobus, and R. Klingner. 1989. *In-Plane Seismic Resistance of Two-story Concrete Masonry Coupled Shear Walls*, TCCMaR Report 3.1(c)-1.
- Okamoto, S., Y. Yamazaki, T. Kaminosono, M. Teshigawara, and H. Hirashi. 1987. "Seismic Capacity of Reinforced Masonry Walls and Beams in Wind and Seismic Effects." In *Proceedings of the 18th joint Meeting, U.S. - Japan Panel on Wind and Seismic Effects*, ed. by N. J. Raufaste, Report NBSIR 87-3540. Gaithersburg, Maryland: National Institute of Standards and Technology.
- Priestley, N., and H. Limin. 1990. "Seismic Response of T-Section Masonry Shear Walls." *TMS Journal* 9(1):10-19.
- Seible, F., G. A. Hegemier, M. J. N. Priestley, G. R. Kingsley, A. Kurkchubasche, and A. Igarashi. 1992. *The U.S. - TCCMaR Five-story Full Scale Masonry Research Building Test - Preliminary Report*, TCCMaR Report 9.2-4.
- Shaikh, A. Fattah. 1996. *Design of Hooked Anchor bolts in Concrete and Masonry: Proposed Code Provisions and Commentary*. Prepared for the National Codes and Standards Council, 1996.
- Shing, P. B., J. Noland, H. Spaeh, E. Klammerus, and M. Schuller. 1991. *Response of Singlestory Reinforced Masonry Shear Walls to In-Plane Lateral Loads*, TCCMaR Report 3.1(a)-2.
- Shing, P. B., M. Schuller, and V. S. Hoskere. 1990. "In-Plane Resistance of Masonry Shear Walls," *ASCE Journal of Structural Engineering* 116(3).

Sveinsson, B. I., H. D. McNiven, and H. Sucuoglu. 1985. *Cyclic Shear Tests of Masonry Piers*, Vol. 4, Report UCB/EERC 85-15. Berkeley: University of California Earthquake Engineering Research Center.

Wolde-Tinsae, A. M., R. H. Atkinson, and A. A. Hamid. 1993. "State-of-the-Art Modulus of Elasticity of Masonry." In *Proceedings of the Sixth North American Masonry Conference*. Boulder, Colorado: The Masonry Society.

The following Technical Coordinating Committee for Masonry Research task reports not specifically cited but providing the substantiating data for the strength design criteria presented in this chapter are available through the Earthquake Engineering Research Center Library in Richmond, California (phone 415-231-9403):

Task No. Author(s) and Title

- 1.1-1: Atkinson and Kingsley, *Comparison of the Behavior of Clay & Concrete Masonry in Compression*, September 1985. 151 pgs.
- 1.2(a)-1: Hamid, A. A., G. F. Assis, and H. G. Harris, *Material Models for Grouted Block Masonry*, August 1988. 67 pgs.
- 1.2(a)-2: Assis, G. F., A. A. Hamid, and H. G. Harris, *Material Models for Grouted Block Masonry*, August 1989. 134 pgs.
- 1.2(b)-1: Young, J. M., and R. H. Brown, *Compressive Stress Distribution of Grouted Hollow Clay Masonry Under Strain Gradient*, May 1988, 170 pgs.
- 1.3-1: Atkinson, R. H., *An Assessment of Current Material Test Standards for Masonry Limit States Design Methods*, June 1991. 38 pgs.
- 2.1-1: Hart, G., and M. Basharkhah, *Slender Wall Structural Engineering Analysis Computer Program* (Shwall, Version 1.01), September 1987. 68 pgs.
- 2.1-2: Hart, G., and M. Basharkhah, *Shear Wall Structural Engineering Analysis Computer Program* (Shwall, Version 1.01). September 1987. 75 pgs.
- 2.1-3: Nakaki, D., and G. Hart, *Uplifting Response of Structures Subjected to Earthquake Motions*, August 1987. 200 pgs.
- 2.1-4: Hart, G., N. Sajjad, and M. Basharkhah, *Inelastic Column Analysis Computer Program* (INCAP, Version 1.01), March 1988.
- 2.1-5: Hong, W. K., G. C. Hart, and R. E. Englekirk, *Force-Deflection Evaluation and Models for University of Colorado Flexural Walls*, December 1989.
- 2.1-6: Hart, G. C., J. W. Jaw, and Y. K. Low, *SCM Model for University of Colorado Flexural Walls*, December 1989. 31 pgs.
- 2.1-7: Hart, G. C., N. Sajjad, and M. Basharkhah, *Inelastic Masonry Flexural Shear Wall Analysis Computer Program*, February 1990. 41 pgs.
- 2.1-8: Hart, G. C., R. Englekirk, M. Srinivasan, S. C. Huang, and D. J. Drag, *Seismic Performance Study, DPC Gymnasium, Elastic Time History Analysis Using SAP90*, February 1992. 41 pgs.
- 2.1-9: Hart, G. C., R. Englekirk, M. Srinivasan, S. C. Huang, and D. J. Drag, *Seismic Performance Study, TMS Shopping Center, Elastic Time History Analysis Using SAP90*, February 1992. 42 pgs.
- 2.1-10: Hart, G. C., R. Englekirk, J. W. Jaw, M. Srinivasan, S. C. Huang, and D. J. Drag, *Seismic Performance Study, RCJ Hotel, February 1992*. 51 pgs.

- 2.1-11: Hart, G. C., R. Englekirk, M. Srinivasan, S. C. Huang, and D. J. Drag, *Performance Study, 2-Story Masonry Wall-Frame Building*, February 1992. 112 pgs.
- 2.1-12: Hart, G. C., R. Englekirk, J. W. Jaw, M. Srinivasan, S. C. Huang, and D. J. Drag, *Seismic Performance Study, Designed by Tentative Limit States Design Standard*, February 1992. 75 pgs.
- 2.2-1: Ewing, R. D., A. El-Mustapha, and J. Kariotis, *FEM/I - A Finite Element Computer Program for the Nonlinear Static Analysis of Reinforced Masonry Building Components*, December 1987 (Revised June 1990). 124 pgs.
- 2.2-2: Ewing, R. D., *Parametric Studies on Reinforced Masonry Shear Walls Using FEM/I, A Nonlinear Finite Element Analysis Program*, March 1992.
- 2.2-3: Ewing, R. D., *Finite Element Analysis of Reinforced Masonry Building Components Designed by a Tentative Masonry Limit States Design Standard*, March 1992. 48 pgs.
- 2.3-1: Ewing, R., J. Kariotis, and A. El-Mustapha, *LPM/I, A Computer Program for the Nonlinear, Dynamic Analysis of Lumped Parameter Models*, August, 1987. 200 pgs.
- 2.3-2: Kariotis, J., A. El-Mustapha, and R. Ewing, *Influence of Foundation Model on the Uplifting of Structures*, July 1988. 50 pgs.
- 2.3-3: Kariotis, J., A. Rahman, and A. El-Mustapha, *Investigation of Current Seismic Design Provisions for Reinforced Masonry Shear Walls*, January 1990. 48 pgs.
- 2.3-4: Kariotis, J., A. Rahman, O. Waqfi, and R. Ewing, *Version 1.03 LPM/I - A Computer Program for the Nonlinear, Dynamic Analysis of Lumped Parameter Models*, February 1992. 227 pgs.
- 2.3-5: Kariotis, J., O. Waqfi, and R. Ewing, R., *A Computer Program Using Beam Elements for the Nonlinear, Dynamic Analysis of Lumped Parameter Models*, February 1992. 96 pgs.
- 2.3-6: Kariotis, J., and O. Waqfi, *Comparison of the Dynamic Response of a Damped MDOF Nonlinear Beam Model with an Equivalent SDOF Hysteretic Model*, April 1992. 88 pgs.
- 2.3-7: Kariotis, J., and O. Waqfi, *Recommended Procedure for Calculation of the Balanced Reinforcement Ratio*, February 1992. 73 pgs.
- 2.4(b)-1: Button, M. R., and R. L. Mayes, *Out-of-Plane Seismic Response of Reinforced Masonry Walls: Correlation of Full-Scale Test and Analytical Model Results*, March 1991. 65 pgs.
- 3.1(a)-1: Scrivener, J., *Summary of Findings of Cyclic Tests on Masonry Piers*, June 1986. 7 pgs.
- 3.1(a)-2: Shing, P. B., J. Noland, H. Spaeh, E. Klamerus, and M. Schuller, *Response of Single-Story Reinforced Masonry Shear Walls to In-Plane Lateral Loads*, January 1991. 136 pgs.
- 3.1(b)-1: Seible, F., and H. LaRovere, *Summary of Pseudo Dynamic Testing*, February 1987. 46 pgs.
- 3.1(b)-2: Igarashi, A., F. Seible, and G. Hegemier, *Development of the Generated Sequential Displacement Procedure and the Simulated Seismic Testing of the TCCMaR Three-Story In-Plane Walls*, June 1993.
- 3.1(c)-1: Merryman, K., G. Leiva, B. Antrobus, and R. Klingner, *In-Plane Seismic Resistance of Two-Story Concrete Masonry Coupled Shear Walls*, September 1989. 176 pgs.
- 3.1(c)-2: Leiva, G., and R. Klingner, *In-plane Seismic Resistance of Two-story Concrete Masonry Shear Walls with Openings*, August 1991. 326 pgs.
- 3.2(a)-1: Hamid, A., B. Abboud, M. Farah, K. Hatem, and H. Harris, *Response of Reinforced Block Masonry Walls to Out-of-Plane Static Loads*, September 1989. 120 pgs.

- 3.2(b)-1: Agbabian, M., S. Adham, S. Masri, V. Avanesian, and V. Traina, *Out-of-Plane Dynamic Testing of Concrete Masonry Walls*, Vol. 1 and 2, July 1989. 220 pgs.
- 3.2(b)-2: Blondet, M., and R. L. Mayes, *The Transverse Response of Clay Masonry Walls Subjected to Strong Motion Earthquakes*, Vol. 1: General Information, April 1991. 172 pgs.
- 3.2(b)-2: Blondet, M., and R. L. Mayes, *The Transverse Response of Clay Masonry Walls Subjected to Strong Motion Earthquakes*, Vol. 2: Walls No. 4 and 6 (Group 1), April 1991. 267 pgs.
- 3.2(b)-2: Blondet, M., and R. L. Mayes, *The Transverse Response of Clay Masonry Walls Subjected to Strong Motion Earthquakes*, Vol. 3: Walls No. 8, 9, 10 and 11 (Group 2), April 1991. 310 pgs.
- 3.2(b)-2: Blondet, M., and R. L. Mayes, *The Transverse Response of Clay Masonry Walls Subjected to Strong Motion Earthquakes*, Vol. 4: Walls No. 3, 5, and 7 (Group 3), April 1991. 256 pgs.
- 4.1-1: He, L., and M. J. N. Priestley, *Seismic Behavior of Flanged Masonry Shear Walls*, May 1988. 119 pgs.
- 4.1-2: He, L., and M. J. N. Priestley, *Seismic Behavior of Flanged Masonry Shear Walls - Final Report*, November 1992. 279 pgs.
- 4.2-1: Hegemier, G., and H. Murakami, *On the Behavior of Floor-to-Wall Intersections in Concrete Masonry Construction*, Part I: Experimental.
- 4.2-2: Hegemier, G., and H. Murakami, *On the Behavior of Floor-to-Wall Intersections in Concrete Masonry Construction*, Part II: Theoretical.
- 5.1-1: Porter, M., and A. Sabri, *Plank Diaphragm Characteristics*, July 1990. 226 pgs.
- 5.2-1: Porter, M., F. Yeomans, and A. Johns, *Assembly of Existing Diaphragm Data*, July 1990. 142 pgs.
- 6.2-1: Scrivener, J., *Bond of Reinforcement in Grouted Hollow-Unit Masonry: A State-of-the-Art*, June 1986. 53 pgs.
- 6.2-2: Soric, Z., and L. Tulin, *Bond Splices in Reinforced Masonry*, August 1987. 296 pgs.
- 7.1-1: Paulson, T., and D. Abrams, *Measured Inelastic Response of Reinforced Masonry Building structures to Earthquake Motions*, October 1990. 294 pgs.
- 8.1-1: Hart, G., *A Limit State Design Method for Reinforced Masonry*, June 1988.
- 8.1-2: Hart, G., *Expected Value Design in the Context of a Limit State Design Methodology*, February 1990.
- 8.2-1: Hart, G., and G. T. Zorapapel, *Reliability of Concrete Masonry Wall Structures*, December 1991. 229 pgs.
- 8.2-2: Hart, G., and N. Sajjad, *Confinement in Concrete Masonry*, December 1990.
- 8.2-3: Hart, G., and J. Jang, *Seismic Performance of Masonry Wall Frames*, December 1991.
- 9.1-1: Kariotis, J. C., and A. W. Johnson, *Design of Reinforced Masonry Research Building*, September 1987. 42 pgs.
- 9.1-2: Kariotis, J. C., and O. M. Waqfi, *Trial Designs Made in Accordance with Tentative Limit States Design Standards for Reinforced Masonry Buildings*, February 1992. 184 pgs.
- 9.2-1: Seible, F., *Report on Large Structures Testing Facilities in Japan*, September 1985. 120 pgs.

- 9.2-2: Seible, F., *Design and Construction of the Charles Lee Powell Structural Systems Laboratory*, November 1986. 65 pgs.
- 9.2-3: Seible, F., *The Japanese Five-story Full Scale Reinforced Masonry Building Test*, January 1988. 100 pgs.
- 9.2-4: Seible, F., G. A. Hegemier, M. J. N. Priestley, G. R. Kingsley, A. Kurkchubasche, and A. Igarashi, *The U.S. - TCCMaR Five-story Full Scale Masonry Research Building Test - Preliminary Report*, October 1992. 58 pgs.
- 11.1-1: TCCMaR, *Summary Report: U.S. Coordinated Program for Masonry Building Research*, September 1985 to August 1986. 190 pgs.
- 11.1-2: TCCMaR, *Status Report: U.S. Coordinated Program for Masonry Building Research*, November 1988. 170 pgs.

Chapter 12 Commentary

WOOD STRUCTURE DESIGN REQUIREMENTS

12.1 GENERAL

12.1.2 References. Wood construction practices have not been codified in a form that is standard throughout the country. The 2003 *Provisions* incorporates by reference the *AF&PA ASD/LRFD Supplement, Special Design Provisions for Wind and Seismic (SDPWS)* and the *2003 International Residential Code (IRC)*. Many wood frame structures are a combination of engineered wood and “conventional” light-frame construction. Wood also is used in combination with other materials (American Institute of Timber Construction, 1985; Breyer, 1993; Faherty and Williamson, 1989; Hoyle and Woeste, 1989; Somayaji, 1992; Stalnaker and Harris, 1989). The requirements of the model building codes were used as a resource in developing the requirements introduced in the 1991 *Provisions* and further modified since then. The general requirements of Chapter 12 cover construction practices necessary to provide a performance level of seismic resistance consistent with the purposes stated in Chapter 1. These requirements also may be related to gravity load capacity and wind force resistance which is a natural outgrowth of any design procedure. For the 2003 *Provisions*, the reference documents continue to be grouped according to their primary focus into three subsections: Sec. 12.1.2.1, Engineered Wood Construction; Sec. 12.1.2.2, Conventional Construction; and Sec. 12.1.2.3, Materials Standards.

12.2 DESIGN METHODS

Prior to the publication of AF&PA/ASCE 16, typical design of wood frame structures followed the American Forest and Paper Association (AF&PA) *National Design Specification for Wood Construction* (NDS) (AF&PA, 1991). The NDS is based on “allowable” stresses and implied factors of safety. However, the design procedure provided by the *Provisions* was developed on the premise of the resistance capacity of members and connections at the yield level (ASCE, 1988; Canadian Wood Council, 1990 and 1991; Keenan, 1986). In order to accommodate this difference in philosophy, the 1994 and prior editions of the *Provisions* made adjustments to the tabulated “allowable” stresses in the reference documents.

With the completion of the *Load and Resistance Factor Standard for Engineered Wood Construction* (AF&PA/ASCE, 1995), the modifications and use of an “allowable” stress based standard was no longer necessary. Therefore, the 1997 *Provisions* included the LRFD standard by reference (AF&PA/ASCE 16) and used it as the primary design procedure for engineered wood construction. The use of AF&PA/ASCE 16 continues in the 2003 *Provisions*.

Conventional light-frame construction, a prescriptive method of constructing wood structures, is allowed for some design categories. These structures must be constructed according to the requirements set forth in Sec. 12.4 and applicable reference documents. If the construction deviates from these prescriptive requirements, the engineered design requirements of Sec. 12.2 and 12.3 and AF&PA/ASCE 16 must be followed. If a structure that is classified as conventional construction contains some structural elements that do not meet the requirements of conventional construction, the elements in question can be engineered without changing the rest of the structure to engineered construction. The extent of design to be provided must be determined by the responsible registered design professional; however, the minimum acceptable extent is often taken to be force transfer into the element, design of the element, and force transfer out of the element. This does not apply to a structure that is principally an engineered structure with minor elements that could be considered conventional. When more than one braced wall line or diaphragm in any area of a conventional residence requires design, the nature of the construction may have changed, and engineered design

might be appropriate for the entire seismic-force-resisting system. The absence of a ceiling diaphragm may also create a configuration that is non-conventional. The requirement for engineering portions of a conventional construction structure to maintain lateral-force resistance and stiffness is added to provide displacement compatibility.

Alternate strength of members and connections. It remains the intent of the *Provisions* that load and resistance factor design be used. When allowable stress design is to be used, however, the factored resistance of members and connections subjected to seismic forces acting alone or in combination with other prescribed loads shall be determined using a capacity reduction factor, ϕ , times 2.16 times the allowable stresses permitted in the *National Design Specification for Wood Construction* (NDS) and supplements (AF&PA, 1991). The allowable stresses used shall not include a duration of load factor, C_D . The value of the capacity reduction factor, ϕ , shall be as follows:

Wood members

In flexure	$\phi = 1.00$
In compression	$\phi = 0.90$
In tension	$\phi = 1.00$
In shear and torsion	$\phi = 1.00$

Connectors

Anchor bolts, bolts, lag bolts, nails, screws, etc.	$\phi = 0.85$
Bolts in single shear in members of a seismic-force-resisting system	$\phi = 0.40$

These “soft” conversions from allowable stress design values to load and resistance factor design values first appeared in Sec. 9.2 in the 1994 *Provisions*. An alternative method of calculating soft conversions is provided in ASTM D 5457-93. The reader is cautioned, however, that the loads and load combinations to be used for conversion are not specified so it is incumbent upon the user to determine appropriate conversion values. Wood frame structures assigned to Seismic Design Category A, other than one- and two-family dwellings, must comply with Sec. 12.4 or if engineered need only comply with the reference documents and Sec. 1.5. Exceptions addressing one- and two-family detached dwellings appear in Sec.

12.2.1 Seismic Design Categories B, C, and D. Seismic Design Categories B, C, and D were combined in the 1997 *Provisions*. At the same time, subsections on material limitations and anchorage requirements were moved. This was based on the philosophy that detailing requirements should vary based on R value rather than seismic design category.

Structures assigned to Seismic Design Categories B, C, and D are required to meet the minimum construction requirements of Sec. 12.4 (Sherwood and Stroh, 1989) or must be engineered using standard design methods and principles of mechanics. Conventional light-frame construction requirements were modified in the 1991 *Provisions* to limit the spacing between braced wall lines based on calculated capacities to resist the loads and forces imposed.

Engineered structures assigned to Seismic Design Categories B, C, and D are required to conform to the provisions of Sec. 12.2 and 12.3. Included in these sections are general design limitations, limits on wood resisting forces contributed by concrete or masonry, shear wall and diaphragm aspect ratio limitations, and requirements for distribution of shear to vertical resisting elements.

12.2.2 Seismic Design Categories E and F. If the provisions of Chapter 12 apply, Seismic Design Category E and F structures require an engineered design. Conventional construction is not considered rigorous enough for structures expected to be functional following a major seismic event. For Seismic Design Category E and F structures, close attention to load path and detailing is required.

Structures assigned to Seismic Design Category E and F require blocked diaphragms. Structural-use panels must be applied directly to the framing members; the use of gypsum wallboard between the structural-use panels and the framing members is prohibited because of the poor performance of nails in gypsum. Restrictions on allowable shear values for structural-use shear panels when used in conjunction with concrete and masonry walls are intended to provide for deformation compatibility of the different materials.

12.2.3.1 Discussion of cyclic test protocol is included in ATC (1995), Dolan (1996), and Rose (1996).

12.2.3.2 and 12.2.3.7 The mid-span deflection of a simple-span, blocked wood structural panel diaphragm uniformly nailed throughout may be calculated by use of the following formula:

$$\Delta = \frac{5vL^3}{8bEA} + \frac{vL}{4Gt} + 0.188Le_n + \frac{\Sigma(\Delta_c X)}{2b}$$

where:

- Δ = the calculated deflection, in. (mm).
- v = maximum shear due to factored design loads in the direction under consideration, lb/ft (kN/m).
- L = diaphragm length, ft (m).
- b = diaphragm width, ft (m).
- E = elastic modulus of chords, psi (MPa).
- A = area of chord cross-section, in.² (mm²).
- Gt = panel rigidity through the thickness, lb/in. (N/mm).
- e_n = nail deformation, in. (mm).
- $\Sigma(\Delta_c X)$ = sum of individual chord-splice slip values on both sides of the diaphragm, each multiplied by its distance to the nearest support, in. (mm).

If not uniformly nailed, the constant 0.188 in the third term must be modified accordingly. See ATC 7 (Applied Technology Council, 1981).

This formula was developed based on engineering principles and monotonic testing. Therefore, it provides an estimate of diaphragm deflection due to loads applied in the factored resistance shear range. The effects of cyclic loading and resulting energy dissipation may alter the values for nail deformation in the third term, as well as chord splice effects of the fourth term, if mechanically-spliced wood chords are used. The formula is not applicable to partially-blocked diaphragms.

The deflection of a blocked wood structural panel shear wall may be calculated by use of the following formula.

$$\Delta = \frac{8vh^3}{bEA} + \frac{vh}{Gt} + 0.75he_n + \frac{h}{b}d_a$$

where:

- Δ = the calculated deflection, in. (mm).
- v = maximum shear due to factored design loads at the top of the wall, lb/ft (kN/m).

- h = shear wall height, ft (m).
 b = shear wall width, ft (m).
 E = elastic modulus of boundary element (vertical member at shear wall boundary), psi (MPa).
 A = area of boundary element cross-section (vertical member at shear wall boundary), in.² (mm²).
 Gt = panel rigidity through the thickness, lb/in. (N/mm).
 e_n = nail deformation, in. (mm).
 d_a = deflection due to anchorage details (rotation and slip at hold downs), in. (mm).

Guidance for use of the above two equations can be found in the references.

One stipulation is that there are no accepted rational methods for calculating deflections for diaphragms and shear walls that are sheathed with materials other than wood structural panel products fastened with nails. Therefore, if a rational method is to be used, the capacity of the fastener in the sheathing material must be validated by acceptable test procedures employing cyclic forces or displacements. Validation must include correlation between the overall stiffness and capacity predicted by principles of mechanics and that observed from test results. A diaphragm or shear wall sheathed with dissimilar materials on the two faces should be designed as a single-sided wall using the capacity of the stronger of the materials and ignoring the weaker of the materials.

TABLE C12.2A
“ e_n ” FASTENER SLIP EQUATIONS FOR USE IN CALCULATING DIAPHRAGM
AND SHEAR WALL DEFLECTION DUE TO FASTENER SLIP

Fastener	Minimum Penetration (in.)	Maximum Fastener Loads - V_n (lb/fastener)	Fastener Slip, e_n (in.) ¹	
			Fabricated w/green (>19% m.c.) lumber	Fabricated w/dry (\leq 19% m.c.) lumber
6d common nail	1-1/4	180	$(V_n/434)^{2.314}$	$(V_n/456)^{3.144}$
8d common nail	1-3/8	220	$(V_n/857)^{1.869}$	$(V_n/616)^{3.018}$
10d common nail	1-1/2	260	$(V_n/977)^{1.894}$	$(V_n/769)^{3.276}$
14-ga staple	1 to <2	140	$(V_n/902)^{1.464}$	$(V_n/596)^{1.999}$
14-ga staple	≥ 2	170	$(V_n/674)^{1.873}$	$(V_n/461)^{2.776}$

For SI: 1 inch = 25.4 mm, 1 pound = 4.448 N.

1. Values apply to plywood and OSB fastened to lumber with a specific gravity of 0.50 or greater except that the slip shall be increased by 20 percent when plywood is not Structural I.

TABLE C12.2B
VALUES OF G_t FOR USE IN CALCULATING DEFLECTION OF
WOOD STRUCTURAL PANEL DIAPHRAGMS AND SHEAR WALLS

PANEL TYPE	MINIMUM THICKNESS (in.)	SPAN RATING	VALUES OF G_t (lb/in. panel depth or width)						
			STRUCTURAL I			OTHER			
			3-ply Plywood	4- and 5-ply Plywood ¹	OSB	3-ply Plywood	4-ply Plywood	5-ply Plywood ¹	OSB
Sheathing	3/8	24/0	32,500	41,500	77,500	25,000	32,500	37,500	77,500
	7/16	24/16	35,000	44,500	83,500	27,000	35,000	40,500	83,500
	15/32	32/16	35,000	44,500	83,500	27,000	35,000	40,500	83,500
	19/32	40/20	37,000	47,500	88,500	28,500	37,000	43,000	88,500
	23/32	48/24	40,500	51,000	96,000	31,000	40,500	46,500	96,000
	19/32	16 oc	35,000	44,500	83,500	27,000	35,000	40,500	83,500
Single Floor	19/32	20 oc	36,500	46,000	87,000	28,000	36,500	42,000	87,000
	23/32	24 oc	39,000	49,500	93,000	30,000	39,000	45,000	93,000
	7/8	32 oc	47,000	59,500	110,000	36,000	47,000	54,000	110,000
	1-1/8	48 oc	65,500	83,500	155,000	50,500	65,500	76,000	155,000

PANEL TYPE	Thickness (in.)	VALUES OF G_t (lb/in. panel depth or width)		
		STRUCTURAL I		OTHER
		All Plywood Grades	Marine	All Other Plywood Grades
Sanded Plywood	1/4	31,000	31,000	24,000
	11/32	33,000	33,000	25,500
	3/8	34,000	34,000	26,000
	15/32	49,500	49,500	38,000
	1/2	50,000	50,000	38,500
	19/32	63,500	63,500	49,000
	5/8	64,500	64,500	49,500
	23/32	65,500	65,500	50,500
	3/4	66,500	66,500	51,000
	7/8	68,500	68,500	52,500
	1	95,500	95,500	73,500
	1-1/8	97,500	97,500	75,000

For SI: 1 inch = 25.4 mm, 1 pound/inch of panel depth or width = 0.1751 N/mm.

1. Applies to plywood with 5 or more layers; for 5 ply/3 layer plywood, use values for 4 ply.

Effect of Green Lumber Framing on Diaphragms and Shear Walls: A recent study of wood structural panel shear walls (APA Report T2002-53) fabricated with wet lumber and tested when dry shows that shear stiffness is affected to a much larger degree than shear strength when compared to control specimens fabricated with dry lumber and tested when dry. The shear strength of walls fabricated with wet lumber showed negligible reductions (0-7 percent) when compared to control specimens. The shear stiffness of walls fabricated with wet lumber was always reduced when compared to control specimens. Observed reductions in stiffness were consistent with predicted stiffness reductions based on use of Eq. C12.2A and nail slip values specified in Table C12.2A. For example, measured deflection of a standard wall configuration at the shear wall factored unit shear value was approximately 2.5 times the deflection of the control specimen and predicted deflections were within 0.05 inches of the test deflection for both the fabricated wet specimen and control specimen.

As a result of these tests, direct consideration of shear wall stiffness is recommended in lieu of applying shear wall strength reductions when wood structural panel shear walls are fabricated with wet lumber (e.g. moisture content > 19 percent). To address reduced shear stiffness for shear walls fabricated with wet lumber, story drift calculations should be based on e_n values for lumber with moisture content > 19 percent to determine compliance with allowable story drift limits of the Provisions. A similar relationship can be expected when analyzing the deflection of diaphragms.

The designer should keep in mind that deflection equations are verified for walls with wood structural panel sheathing only and does not address the increased stiffness provided by finish materials such as gypsum and stucco. The CUREE-Caltech Woodframe project illustrated that finishes such as gypsum wallboard and stucco increase the stiffness of the walls. While these

deflection equations are currently the best estimate of wood structural panel wall deflection, actual wall deflections will likely be less than predicted deflections due to the presence of finish materials in typical wall construction.

12.2.3.11 and 12.2.3.12. Tie-down devices should be based on cyclic tests of the connection to provide displacement capacity that allows rotation of the end post without significant reduction in the shear wall resistance. The tie-down device should be stronger than the lateral capacity of the wall so that the mechanism of failure is the sheathing fasteners and not a relatively brittle failure of the wall anchorage. For devices for which the published resistance is in allowable stress design values, the nominal strength shall be determined by multiplying the allowable design load by 1.3. The nominal strength of a tie-down device may be determined as the average maximum test load resisted without failing under cyclic loading. In that case, the average should be based on tests of at least three specimens.

Calculations of deflection of shear walls should include the effects of crushing under the compression chord, uplift of the tension chord, slip in the tie-down anchor with respect to the post, and shrinkage effects of the platforms, which primarily consist of floor framing members. Movement associated with these variables can be significant and neglecting their contribution to the lateral displacement of the wall will result in a significant under-estimation of the deflection. Custom tie-down devices are permitted to be designed using methods for the particular materials used and AF&PA/ASCE 16 under alternative means and methods.

Tie-down devices that permit significant vertical movement between the tie-down and the tie-down post can cause failure in the nails connecting the shear wall sheathing to the sill plate. High tension and tie-down rotation due to eccentricity can cause the bolts connecting the tie-down bracket to the tie-down post to pull through and split the tie-down post. Devices that permit such movement include heavily loaded, one-sided, bolted connections with small dimensions between elements resisting rotation due to eccentricity. Any device that uses over-drilled holes, such as most bolted connections, will also allow significant slip to occur between the device and the tie-down post before load is restrained. Both the NDS and the steel manual specify that bolt holes will be over-drilled as much as 1/16 in. (2 mm). This slip is what causes much of the damage to the nails connecting the sheathing to the sill plate. Friction between the tie-down post and the device cannot be counted on to resist load because relaxation in the wood will cause a loss of clamping and, therefore, a loss in friction over time. This is why all tests should be conducted with the bolts “finger tight” as opposed to tightening with a wrench.

Cyclic tests of tie-down connections must follow a pattern similar to the sequential phased displacement (SPD) tests used by Dolan (1996) and Rose (1996). These tests used full wall assemblies and therefore induced deflection patterns similar to those expected during an earthquake. If full wall assembly tests are not used to test the tie-down devices, it must be shown that the expected rotation as well as tension and compression are used. This is to ensure that walls using the devices will be able to deform in the intended manner. This allows the registered design professional to consider compatibility of deformations when designing the structure.

Splitting of the bottom plate of the shear walls has been observed in tests as well as in structures subjected to earthquakes. Splitting of plates remote from the end of the shear wall can be caused by the rotation of individual sheathing panels inducing upward forces in the nails at one end of the panel and downward forces at the other. With the upward forces on the nails and a significant distance perpendicular to the wall to the downward force produced by the anchor bolt, high cross-grain bending stresses occur. Splitting can be reduced or eliminated by use of large plate washers that are sufficiently stiff to reduce the eccentricity and by use of thicker sill plates. Thicker sill plates (3 in. nominal, 65 mm) are recommended for all shear walls for which Table 12.2-3a (or 12.2-3b) requires 3 in. nominal (65 mm) framing to prevent splitting due to close nail spacing. This is to help prevent failure of the sill plate due to high lateral loading and cross-grain bending.

The tendency for the nut on a tie-down bracket anchor bolt to loosen significantly during cycled loading has been observed in some testing. One tested method of limiting the loosening is to apply adhesive between the nut and tie-down bolt.

A logical load path for the structure must be provided so that the forces induced in the upper portions of the structure are transmitted adequately through the lower portions of the structure to the foundation.

In the 2003 *Provisions* update cycle anchorage provisions were divided into two distinct subsections to separately address anchorage for uplift and anchorage for in-plane shear. The title section was clarified to address both traditional segmented shear walls and perforated shear walls.

A prior *Provisions* requirement that nuts on both uplift anchors and in-plane shear anchors be prevented from loosening prior to covering the framing, was deleted. This provision was originally based on observed backing-off of nuts in a small number of cyclic tests of shear walls but in the large number of tests conducted since that time this phenomenon has not been observed to occur. It was felt that retaining the existing requirement for tightening the nuts prior to closing in the framing was sufficient to address this issue.

A prior *Provisions* requirement for the nominal strength of a tiedown to be equal to or exceed the factored resistance of the shear wall times $\Omega_o / 1.3$, was replaced with simpler wording that has an equivalent effect and is intended primarily as a statement of design philosophy. The new language in Sec 12.2.3.11 only refers to the nominal strength of the tiedown and the nominal strength of the shear wall. Nominal strengths for typical nailed wood structural panel shear walls are set forth in Table 4.3A column B of AF&PA *ASD/LRFD Supplement, Special Design Provisions for Wind and Seismic*. In addition, similar language making the nominal strength of in-plane shear anchorage match the nominal strength values of the shear walls was added, to provide a basis for design of in-plane shear connections that is consistent with requirements for uplift anchorage. The capacity-based nominal strength have been introduced primarily as a statement of design philosophy, with the intent of forcing sheathing nailing to be the controlling failure mechanism. The complexity of load paths in wood frame buildings suggest that additional study is needed to achieve reliable development of desired failure mechanisms.

Plate washers are now specifically permitted to have a diagonal slot not exceeding 1-3/4 inches in length to facilitate placement within the width of the sill plate.

12.2.3.14 Sheathing nails should be driven flush with the surface of the panel, and not further. This could result in the nail head creating a small depression in, but not fracturing, the first veneer. This requirement is imposed because of the significant reduction in capacity and ductility observed in shear walls constructed with over-driven nails. It is advised that the edge distance for sheathing nails be increased as much as possible along the bottom of the panel to reduce the potential for the nails to pull through the sheathing.

12.3 GENERAL DESIGN REQUIREMENTS FOR ENGINEERED WOOD CONSTRUCTION

Engineered construction for wood structures as defined by the *Provisions* encompasses all structures that cannot be classified as conventional construction. Therefore, any structure exceeding the height limitations or having braced walls spaced at intervals greater than those prescribed in Table 12.4-1 or not conforming to the requirements in Sec. 12.4 must be engineered using standard design methods and principles of mechanics. Framing members in engineered wood construction are sized based on calculated capacities to resist the loads and forces imposed. Construction techniques that utilize wood for lateral force resistance in the form of diaphragms or shear walls are discussed further in Sec. 12.4. Limitations have been set on the use of wood diaphragms that are used in combination with concrete and masonry walls or where torsion is induced by the arrangement of the vertical resisting elements. A load path must be provided to transmit the lateral forces from the diaphragm through the vertical resisting elements to the foundation. It is important for the registered

design professional to follow the forces down, as for gravity loads, designing each connection and member along the load path.

Although wood moment resisting frames are not specifically covered in the *Provisions*, they are not excluded by them. There are several technical references for their design, and they have been used in Canada, Europe, and New Zealand. Wood moment resisting frames are designed to resist both vertical loads and lateral forces. Detailing at columns to beam/girder connections is critical in developing frame action and must incorporate effects of member shrinkage. Detailed information can be obtained from the national wood research laboratories. There are many references that describe the engineering practices and procedures used to design wood structures that will perform adequately when subjected to lateral forces. The list at the end of this *Commentary* chapter gives some, but by no means all, of these.

Deformation compatibility The registered design professional should visualize the deformed shape of the structure to ensure that the connections provide the necessary ductility to allow the probable deflection demand placed on the structure. Unlike steel or other metal structures, wood is not a ductile material and virtually all of the ductility achieved in the structure is in the connections. The planned failure mechanism of wood structures must be through the connections, including the nailing of structural panels; otherwise the failure will be brittle in nature. The philosophy of strong, elastic columns and yielding beams cannot be projected from steel to wood structures. To enable a wood structure to deform and dissipate energy during a seismic event, the connections must be the weak link in the structure and must be ductile. Recent earthquakes, such as that in Northridge, California, have shown failures due to the fact that consideration of deformation compatibility was neglected.

As an example of a compatibility issue, consider the deformation compatibility between a tie-down connector to the tie-down post and the edge nailing of shear wall sheathing to the tie-down post and adjacent bottom plate. Recent testing and observations from the Northridge earthquake have suggested that the tie-down post experiences notable displacement before significant load can be carried through the tie-down connector. This is due, among other things, to the oversizing of the bolt holes in the tie-down post and the deformation and rotation of the tie-down bracket. Anchor bolts connecting the bottom plate to the foundation below tend to attempt to carry the shear wall uplift as the tie-down post moves. The sheathing, however, is nailed to both the bottom plate, which is held in place, and the tie-down post, which is being pulled up. The result is a large deformation demand being placed on the nails connecting the sheathing to the framing. This often results in the nails pulling out of the sheathing at the tie-down post corner and sometimes results in an unzipping effect where a significant portion of the remaining sheathing nailing fails as high loads cause one nailed connection to fail and move on to overstress the next nail. The most effective solution currently known is to limit the slip and deformation at the tie-down post by using a very stiff nailed or screwed tie-down.

Because this is an area where understanding of compatibility issues is just starting to develop, the Sec. 12.3.2 provision uses the wording “shall be considered in design” in lieu of the originally proposed “provision shall be made to ensure...” The intent is to provide guidance while not requiring the impossible.

If necessary, the stiffness of the wood diaphragms and shear walls can be increased with the use of adhesives (if adhesives are to be used). However, it should be noted that there are no rational methods for determining deflections in diaphragms that are constructed with non-wood sheathing materials. If the nail stiffness values or shear stiffness of non-wood sheathing materials is determined in a scientific manner, such as through experimental cyclic testing, the calculations for determining the stiffness of shear panels will be considered validated.

Limitation on forces contributed by concrete or masonry. Due to the significant difference in in-plane stiffness between wood and masonry or concrete systems, the use of wood members to resist the seismic forces produced by masonry and concrete is not allowed. This is due to the probable torsional response such a structure will exhibit. There are two exceptions where wood can be considered to be part of the seismic-load-resisting system. The first is where the wood is in the form of a horizontal truss or diaphragm and the lateral loads do not produce rotation of the horizontal member. The second exception is in structures of two stories or less in height. In this case, the capacity of the wood shear walls will be sufficient to resist the lower magnitude loads imposed. Five restrictions are imposed on these structures to ensure that the structural performance will not include rotational response and that the drift will not cause failure of the masonry or concrete portions of the structure.

Shearwalls and Diaphragms. Many wood-framed structures resist seismic forces by acting as a “box system.” The forces are transmitted through diaphragms, such as roofs and floors, to reactions provided by shear walls. The forces are, in turn, transmitted to the lower stories and to the final point of resistance, the foundations. A shear wall is a vertical diaphragm generally considered to act as a cantilever from the foundation.

A diaphragm is a nearly horizontal structural unit that acts as a deep beam or girder when flexible in comparison to its supports and as a plate when rigid in comparison to its supports. The analogy to a girder is somewhat more appropriate since girders and diaphragms are made up as assemblies (American Plywood Association, 1991; Applied Technology Council, 1981). Sheathing acts as the “web” to resist the shear in diaphragms and is stiffened by the framing members, which also provide support for gravity loads. Flexure is resisted by the edge elements acting like “flanges” to resist induced tension or compression forces. The “flanges” may be top plates, ledgers, bond beams, or any other continuous element at the perimeter of the diaphragm.

The “flange” (chord) can serve several functions at the same time, providing resistance to loads and forces from different sources. When it functions as the tension or compression flange of the “girder,” it is important that the connection to the “web” be designed to accomplish the shear transfer. Since most diaphragm “flanges” consist of many pieces, it is important that the splices be designed to transmit the tension or compression occurring at the location of the splice and to recognize that the direction of application of seismic forces can reverse. It should also be recognized that the shear walls parallel to the flanges may be acting with the flanges to distribute the diaphragm shears. When seismic forces are delivered at right angles to the direction considered previously, the “flange” becomes a part of the reaction system. It may function to transfer the diaphragm shear to the shear wall(s), either directly or as a drag strut between segments of shear walls that are not continuous along the length of the diaphragm.

For shear walls, which may be considered to be deep vertical cantilever beams, the “flanges” are subjected to tension and compression while the “webs” resist the shear. It is important that the “flange” members, splices at intermediate floors, and the connection to the foundation be detailed and sized for the induced forces.

The “webs” of diaphragms and shear walls often have openings. The transfer of forces around openings can be treated similarly to openings in the webs of steel girders. Members at the edges of openings have forces due to flexure and the higher web shear induced in them and the resultant forces must be transferred into the body of the diaphragm beyond the opening.

In the past, wood sheathed diaphragms have been considered to be flexible by many registered design professionals and model code enforcement agencies. The newer versions of the model codes now recognize that the determination of rigidity or flexibility for determination of how forces will be distributed is dependent on the relative deformations of the horizontal and vertical force-resisting elements. Wood sheathed diaphragms in structures with wood frame shear walls with various types of sheathing may be relatively rigid compared with the vertical resisting system and, therefore, capable of transmitting torsional lateral forces. A diaphragm is considered to be flexible if its

deformation is two or more times that of the vertical force-resisting elements subjected to the same force.

Discussions of these and other topics related to diaphragm and shear wall design, such as cyclic testing and pitched or notched diaphragms, may be found in the references.

The capacity of shear walls must be determined either from tabulated values that are based on experimental results or from standard principles of mechanics. The tables of allowable values for shear walls sheathed with other than wood or wood-based structural-use panels were eliminated in the 1991 *Provisions* as a result of re-learning the lessons from past earthquakes and testing on the performance of structures sheathed with these materials during the Northridge earthquake. In the 1997 *Provisions* values for capacity for shear walls sheathed with wood structural panels were reduced from monotonic test values by 10 percent to account for the reduction in capacity observed during cyclic tests. This decision was reviewed for the 2000 edition of the *Provisions* due to the availability of an expanded data set of test results. The reduction was removed for the 2000 *Provisions* when the effect of the test loading protocol was determined to be the cause of the initial perceived reductions. Capacities for diaphragms were not reduced from the monotonic test values because the severe damage that occurred in shear walls has not been noted in diaphragms in recent earthquakes.

The *Provisions* are based on assemblies having energy dissipation capacities which were recognized in setting the *R* factors. For diaphragms and shear walls utilizing wood framing, the energy dissipation is almost entirely due to nail bending. Fasteners other than nails and staples have not been extensively tested under cyclic load application. When screws or adhesives have been tested in assemblies subjected to cyclic loading, they have had a brittle mode of failure. For this reason, adhesives are prohibited for wood framed shear wall assemblies in SDC C and higher and only the tabulated values for nailed or stapled sheathing are recommended. If one wished to use shear wall sheathing attached with adhesives, as an alternate method of construction in accordance with Sec. 1.1.2.5, caution should be used (Dolan and White, 1992; Foschi and Filiatrault, 1990). The increased stiffness will result in larger forces being attracted to the structure. The anchorage connections and adjoining assemblies must, therefore, be designed for these increased forces. Due to the brittle failure mode, these walls should be designed to remain elastic, similar to unreinforced masonry. The use of adhesives for attaching sheathing for diaphragms increases their stiffness, and could easily change the diaphragm response from flexible to rigid.

Horizontal distribution of shear. The *Provisions* define when a diaphragm can be considered to be flexible or rigid. The purpose is to determine whether the diaphragm should have the loads proportioned according to tributary area or stiffness. For flexible diaphragms, the loads should be distributed according to tributary area whereas for rigid diaphragms, the loads should be distributed according to stiffness.

The distribution of seismic forces to the vertical elements (shear walls) of the seismic-force-resisting system is dependent, first, on the stiffness of the vertical elements relative to that of the horizontal elements and, second, on the relative stiffness of the various vertical elements if they have varying deflection characteristics. The first issue is discussed in detail in the *Provisions*, which define when a diaphragm can be considered flexible or rigid and set limits on diaphragms that act in rotation or that cantilever. The second is largely an issue of engineering mechanics, but is discussed here because significant variations in engineering practice currently exist.

In situations where a series of vertical elements of the seismic-force-resisting system are aligned in a row, seismic forces will distribute to the different elements according to their relative stiffness.

Typical current design practice is to distribute seismic forces to a line of wood structural panel sheathed walls in proportion to the lengths of the wall segments such that each segment carries the same unit load. Wood structural panel sheathed wall segments without openings can generally be calculated to have a stiffness in proportion to the wall length when: the tie-down slip is ignored, the

wood structural panel sheathing is selected from standard selection tables, and the aspect ratio limits of the *Provisions* are satisfied. For stiffness to be proportional to the wall length, the average load per nail for a given nail size must be approximately equal. Conversely, a wall could be stiffened by adding nails and reducing the calculated average load per nail. When including tie-down slip from anchors with negligible slip (1/16 in. [2 mm] or less), the assumption of wall stiffness proportional to length is still fairly reasonable. For larger tie-down slip values, wall stiffness will move towards being proportional to the square of the wall length; more importantly, however, the anchorage will start exhibiting displacement compatibility problems. For shear walls with aspect ratios higher than 2/1, the stiffness is no longer in proportion to the length and equations are not available to reasonably calculate the stiffness. For a line of walls with variations in tie-down slip, chord framing, unit load per nail, or other aspects of construction, distribution of load to wall segments will need to be based on a deflection analysis. The shear wall and diaphragm deflection equations that are currently available are not always accurate. As testing results become available, the deflection calculation formulas will need to be updated and design assumptions for distribution of forces reviewed.

Torsional diaphragm force distribution. A diaphragm is flexible when the maximum lateral deformation of the diaphragm is more than two times the average story drift. Conversely, a diaphragm will be considered rigid when the diaphragm deflection is equal to or less than two times the story drift. This is based on a model building code definition that applies to all materials.

For flexible diaphragms, seismic forces should be distributed to the vertical force-resisting elements according to tributary area or simple beam analysis. Although rotation of the diaphragm may occur because lines of vertical elements have different stiffness, the diaphragm is not considered stiff enough to redistribute seismic forces through rotation. The diaphragm can be visualized as a single-span beam supported on rigid supports.

For diaphragms defined as rigid, rotational or torsional behavior is expected and results in redistribution of shear to the vertical force-resisting elements. Requirements for horizontal shear distribution are in Sec. 5.2.4. Torsional response of a structure due to irregular stiffness at any level within the structure can be a potential cause of failure. As a result, dimensional and diaphragm ratio limitations are provided for different categories of rotation. Also, additional requirements apply when the structure is deemed to have a torsional irregularity in accordance with Table 4.3-2, Item 1a or 1b.

In order to understand limits placed on diaphragms acting in rotation, it is helpful to consider two different categories of diaphragms. Category I includes rigid diaphragms that rely on force transfer through rotation to maintain stability. An example would be an open front structure with shear walls on the other three sides. For this more structurally critical category, applicable limitations are:

Diaphragm may not be used to resist forces contributed by masonry or concrete in structures over one story.

The length of the diaphragm normal to the opening may not exceed 25 ft (to perpendicular shear walls), and diaphragm L/b ratios are limited as noted.

Additional limitations apply when rotation is significant enough to be considered a torsional irregularity.

Category II includes rigid diaphragms that have two or more supporting shear walls in each of two perpendicular directions but, because the center of mass and center of rigidity do not coincide, redistribute forces to shear walls through rotation of the diaphragm. These can be further divided into Category IIA where the center of rigidity and mass are separated by a small portion of the structure's least dimension and the magnitude of the rotation is on the order of the accidental rotation discussed in Sec. 5.2.4.2. For this level of rotation, an exception may result in no particular limitations being placed on diaphragm rotation for Category IIA. Category IIB, rigid diaphragms

with eccentricities larger than those discussed in Sec. 5.2.4.2, are subject to the following limitations:

Diaphragm may not be used to resist forces contributed by masonry or concrete in structures over one story.

Additional limitations apply when rotation is significant enough to be considered a torsional irregularity.

Because flexible diaphragms have very little capacity for distributing torsional forces, further limitation of aspect ratios is used to limit diaphragm deformation such that rigid behavior will occur. The resulting deformation demand on the structure also is limited. Where diaphragm ratios are further limited, exceptions permit higher ratios where calculations demonstrate that higher diaphragm deflections can be tolerated. In this case, it is important to determine the effect of diaphragm rigidity on both the horizontal distribution and the ability of other structural elements to withstand resulting deformations.

Proposals to prohibit wood diaphragms acting in rotation were advanced following the 1994 Northridge earthquake. To date, however, the understanding is that the notable collapses in the Northridge earthquake occurred in part because of lack of deformation compatibility between the various vertical resisting elements rather than because of the inability of the diaphragm to act in rotation.

Diaphragm cantilever. Limitations concerning diaphragms that cantilever horizontally past the outermost shear wall (or other vertical element) are related to but distinct from those imposed because of diaphragm rotation. Such diaphragms can be flexible or rigid and for rigid diaphragms can be Category I, IIA or IIB. Both the limitations based on diaphragm rotation (if applicable) and the following limit on diaphragm cantilever must be considered:

Diaphragm cantilever may not exceed the lesser of 25 ft or two thirds of the diaphragm width.

Relative stiffness of vertical elements. In situations where a series of vertical elements of the seismic-force-resisting system are aligned in a row, the forces will distribute to the different elements according to their relative stiffnesses. This behavior needs to be taken into account whether it involves a series of wood structural panel shear walls of different lengths, a mixture of wood structural panel shear walls with diagonal lumber or non-wood sheathed shear walls, or a mixture of wood shear walls with walls of some other material such as concrete or masonry.

Diaphragm aspect ratio. The L/b for a diaphragm is intended to be the typical definition for aspect ratio. The diaphragm span, L , is measured perpendicular to the direction of applied force, either for the full dimension of the diaphragm or between supports as appropriate. The width, b , is parallel to the applied force (see Figure C12.3-1).

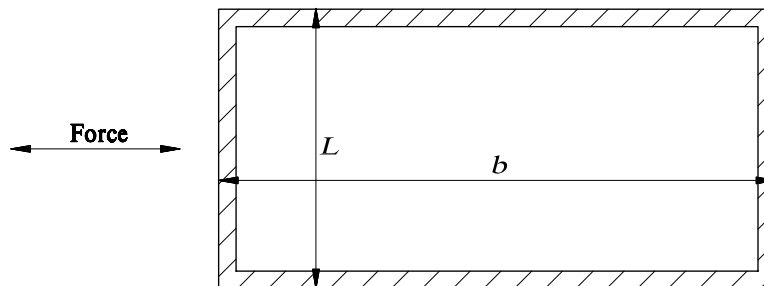

Figure C12.3-1 Diaphragm dimension definitions.

Single and double diagonally sheathed lumber diaphragms. Diagonally sheathed lumber diaphragms are addressed by the *Provisions* because they are still used for new construction in some regions. Shear resistance is based on a soft conversion from the model code allowable stress loads

and capacities to *Provisions* strength loads for regions with high spectral accelerations. This will allow users in the western states, where this construction is currently being used, to continue with little or no change in requirements; at the same time, reasonable values are provided for regions with lower spectral

Shear wall aspect ratio. The h/b for a shear wall is intended to be the typical definitions for aspect ratio. The h of the shear wall is the clear story height (see Figure C12.3-2). The alternate definition of aspect ratio is only to be used where specific design and detailing is provided for force transfer around the openings. It is required that the individual wall piers meet the aspect ratio requirement (see Figure C12.3-3) and that the overall perforated wall also meet the aspect ratio requirement. Use of the alternate definition involves the design and detailing of chord and collector elements around the opening, and often results in the addition of blocking, strapping, and special nailing. As noted, the design for force transfer around the opening must use a rational analysis and be in accordance with AF&PA/ASCE 16, which discusses design principles for shear walls, diaphragms, and boundary elements.

In general, unit shear values for wood structural panel sheathing have been based on tests of shear wall panels with aspect ratios of 2/1 to 1/1. Narrower wall segments (that is, with aspect ratios greater than 2/1) have been a recent concern based on damage observations following the Northridge earthquake and based on results of recent research (Applied Technology Council, 1995; White and Dolan, 1996). In response, various limitations on aspect ratios have been proposed. In the *Provisions*, an aspect ratio adjustment, $2b/h$, is provided to account for the reduced stiffness of narrow shear wall segments. This adjustment is based on a review of numerous tests of narrow aspect ratio walls by Technical Subcommittee 7. The maximum 3.5/1 aspect ratio is recommended based on constructability issues (placement of tie-downs) as well as reduced stiffness of narrower shear wall segments.

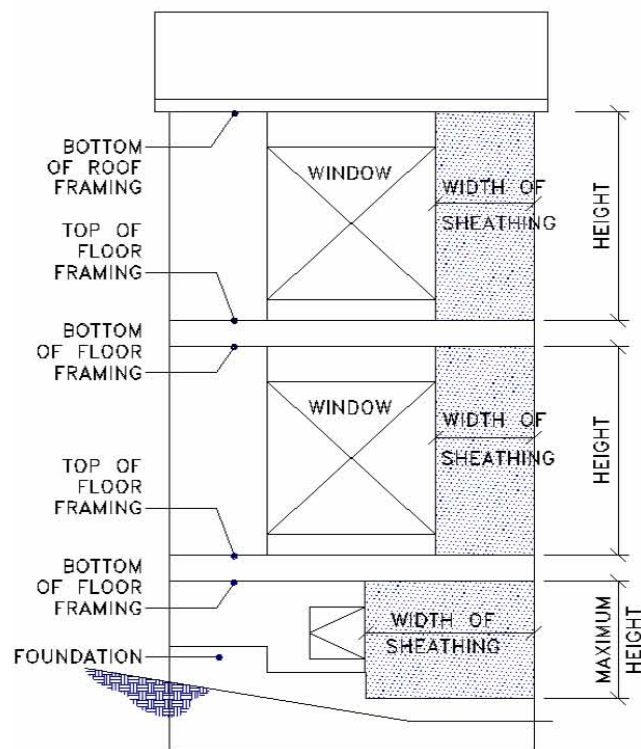

Figure C12.3-2 Typical shear wall height-to-width ratio.

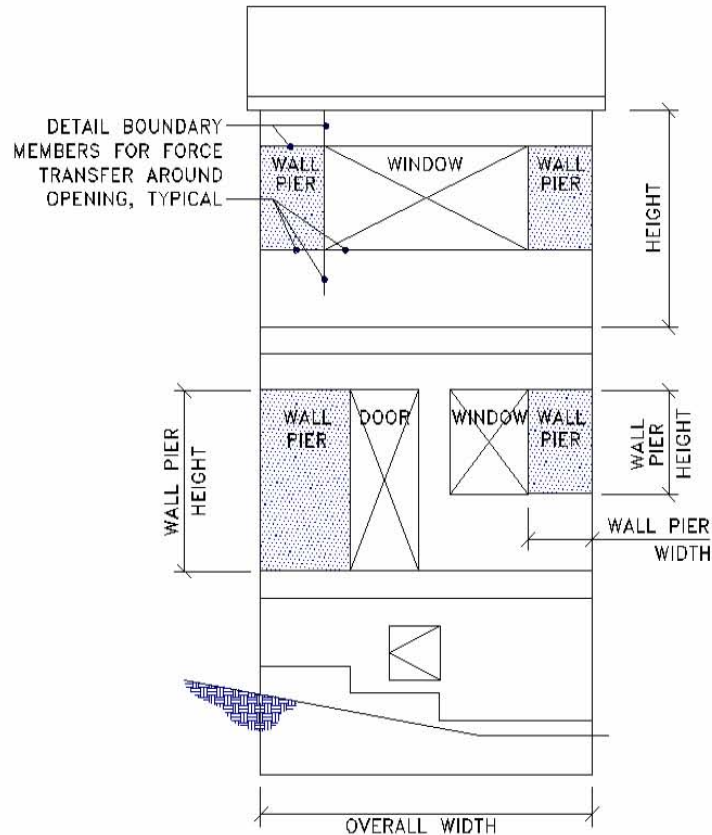

Figure C12.3-3 Alternate shear wall height-to-width ratio with design for force transfer around openings.

Single and double diagonally sheathed lumber shear walls. Diagonally sheathed lumber shear walls are addressed by the *Provisions* because they are still used for new construction in some regions. Resistance values are based on a soft conversion from the model code allowable stress loads and capacities to *Provisions* strength loads for regions with high spectral accelerations. This will allow users in the western states, where this construction is currently being used, to continue with little or no change in requirements; at the same time, reasonable values are provided for regions with lower spectral accelerations.

Perforated shear walls (PSW). In a traditional engineering approach for design of shear walls with openings, design force transfer around the openings involves developing a system of piers and coupling beams within the shear wall. Load paths for the shear and flexure developed in the piers and coupling beams generally require blocking and strapping extending from each corner of the opening to some distance beyond. This approach often results in shear wall detailing that is not practical to construct.

The perforated shear wall approach utilizes empirically based reductions of wood structural panel shear wall capacities to account for the presence of openings that have not been specifically designed and detailed for moment resistance. This method accounts for the capacity that is inherent in standard construction, rather than relying on special construction requirements. It is not expected that sheathed wall areas above and below openings behave as coupling beams acting end to end, but rather that they provide local restraint at their ends. As a consequence significantly reduced capacities are attributed to interior perforated shear wall segments with limited overturning restraint.

Example 1 and Example 2 provide guidance on the application of the perforated shear wall approach.

Perforated Shear Wall Limitations. Perforated shear wall design provisions are applicable to wood structural panel shear walls having characteristics identified in this section.

1. The requirement that perforated shear wall segments be provided at each end of the perforated shear wall ensures that a minimum length of full height sheathing, conforming to applicable aspect ratio limits, is included at each end of a perforated shear wall.
2. A factored shear resistance not to exceed 0.64 klf, based on tabulated LRFD values, is provided to identify a point beyond which other means of shear wall design are likely to be more practical. Connection requirements associated with unadjusted shear resistance greater than 0.64 klf will likely not be practical as other methods of shear wall design will be more efficient.
3. Each perforated shear wall segment must satisfy the requirements for shear wall aspect ratios. The $2b/h$ adjustment for calculation of unadjusted factored shear resistance only applies when shear wall segments with h/b greater than 2:1 but not exceeding 3.5:1 are used in calculating perforated shear wall resistance. When shear wall segments with h/b greater than 2:1 are present in a perforated shear wall, but not utilized in calculation of perforated shear wall resistance, calculation of unadjusted factored shear resistance should not include the $2b/h$ adjustment. In many cases, due to the conservatism of the $2b/h$ adjustment, it is advantageous to simply ignore the presence of shear wall segments with h/b greater than 2:1 when calculating perforated shear wall resistance.
4. No out-of-plane offsets are permitted in a perforated shear wall. While the limit on out-of-plane offsets is not unique to perforated shear walls, it is intended to clearly indicate that a perforated shear wall shall not have out-of-plane (horizontal) offsets.
5. Collectors for shear transfer to each perforated shear wall segment provide for continuity between perforated shear wall segments. This is typically achieved through continuity of the wall double top plates or by attachment of perforated shear wall segments to a common load distributing element such as a floor or roof diaphragm.
6. Uniform top-of-wall and bottom-of-wall elevations are required for use of the empirical shear adjustment factors.
7. Limiting perforated shear wall height to 20 ft addresses practical considerations for use of the method as wall heights greater than 20 ft are uncommon.
 - a. The width, L , of a perforated shear wall and widths L_1 , L_2 and L_3 of perforated shear wall segments are shown in Figure C12.3-4. In accordance with the limitations and anchorage requirements, perforated shear wall segments and overturning restraint must be provided at each end of the perforated shear wall.

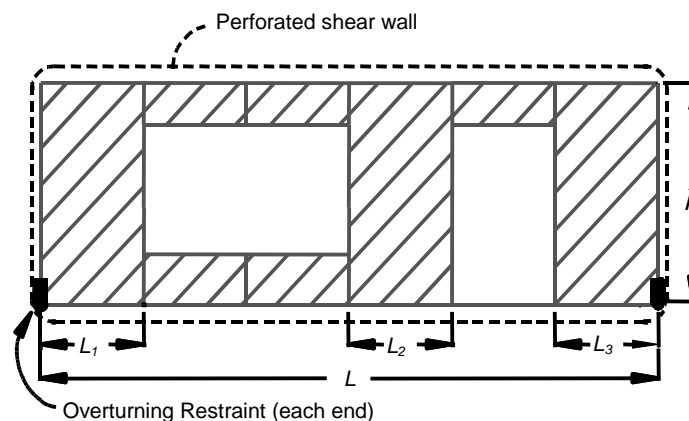

Figure C12.3-4 Perforated shear wall.

Perforated shear wall resistance. Opening adjustment factors are used to reduce shear wall resistance, based on the percent full-height sheathing and the maximum opening height ratio.

Opening adjustment factors are based on the following empirical equation for shear capacity ratio, F , which relates the ratio of the shear capacity for a wall with openings to the shear capacity of a fully sheathed wall (Sugiyama, 1981):

$$F = \frac{4}{3 - 2r} \quad (\text{C12.3-1a})$$

$$r = \frac{1}{1 + \frac{A_o}{h \sum L_i}} \quad (\text{C12.3-1b})$$

where:

- r = sheathing area ratio,
- A_o = total area of openings,
- h = wall height,
- $\sum L_i$ = sum of the width of full-height sheathing.

Agreement between Eq. C12.3-1a and tabulated opening adjustment factors is achieved by recognizing that the tabulated opening adjustment factors are: (1) derived based on an assumption that the height of all openings in a wall are equal to the maximum opening height; and, (2) applied to the sum of the widths of the shear wall segments meeting applicable height-to-width ratios. The assumption that the height of all openings in a wall are equal to the maximum opening height conservatively simplifies tabular presentation of shear capacity adjustment factors for walls with more than one opening height.

Early verification of Eq. C12.3-1a was based on testing of one-third and full-scale shear wall assemblies (Yasumura, 1984; Sugiyama, 1994). More recently, substantial U.S. verification testing of the influence of openings on shear strength and stiffness has taken place (APA, 1996; Dolan and Johnson, 1996; Dolan and Heine, 1997; NAHB-RC, 1998) indicating shear wall performance is consistent with predictions of Eq. C12.3-1a. Results of cyclic testing indicate that the loss in strength due to cyclic loading is reduced for shear walls with openings, indicating good performance relative to that of shear walls without openings. Figure C12.3-5 provides a graphical summary of some recent U.S. verification testing. Data from monotonic tests of 12-ft shear walls (APA, 1996), monotonic and cyclic tests of long shear walls with unsymmetrically placed openings (Dolan and Johnson, 1996), and monotonic and cyclic tests of 16-ft and 20-ft shear walls with narrow wall segments (NAHB-RC, 1998).

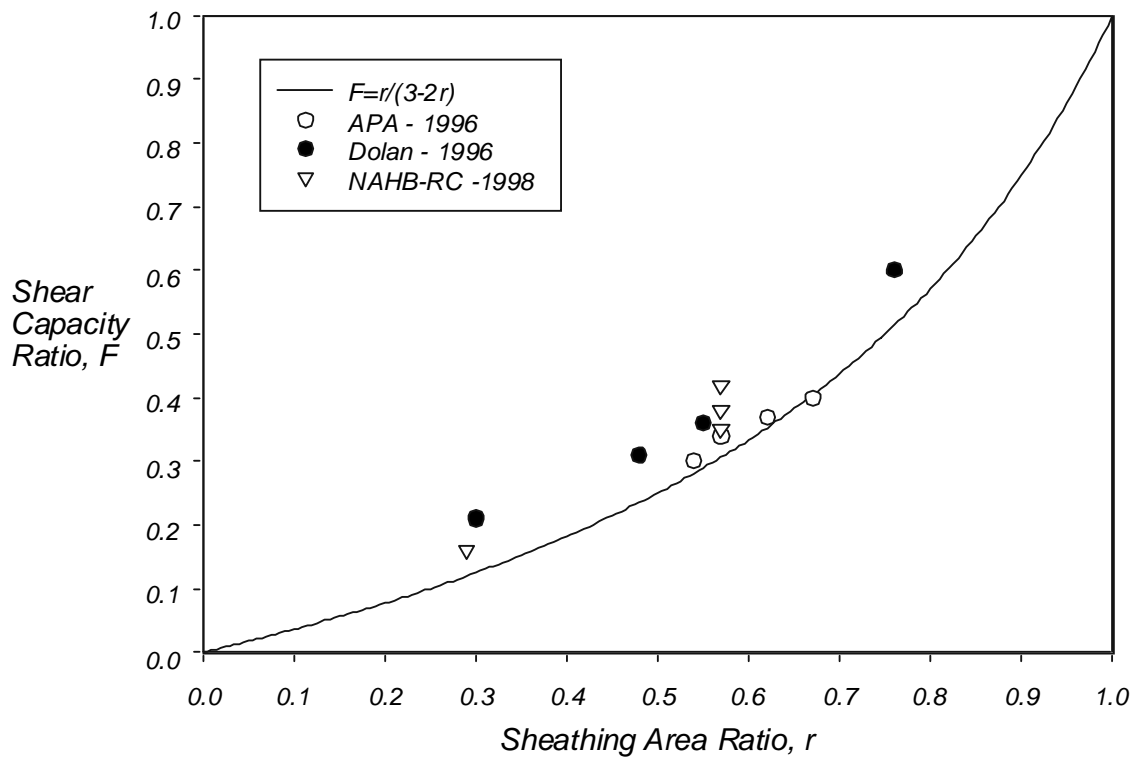

Figure C12.3-5 Shear capacity ratios (actual and predicted).

Eq. C12.3-1a for shear load ratio, F , has been shown to be a good approximation of the stiffness ratio of a wall with openings to that of a fully sheathed wall. Accordingly, the deflection of a perforated shear wall can be calculated as the deflection of an equivalent length fully sheathed wall, divided by the shear load ratio, F .

The percent full-height sheathing and the maximum opening height ratio are used to determine an opening adjustment factor. Maximum opening height is the maximum vertical dimension of an opening within the perforated shear wall. A maximum opening height equal to the wall height is used where structural sheathing is not present above or below window openings or above door openings. The percent full-height sheathing is calculated as the sum of the widths of perforated shear wall segments divided by the total width of the shear wall. Sections sheathed full-height which do not meet aspect ratio limits for wood structural panel shear walls are not considered in calculation of percent full-height sheathing.

PSW Anchorage and load path. Anchorage for uplift at perforated shear wall ends, shear, uplift between perforated shear wall ends, and compression chord forces are prescribed to address the non-uniform distribution of shear within a perforated shear wall.

Prescribed forces for shear and uplift connections ensure that the capacity of the wall is governed by the sheathing to framing attachment (shear wall nailing) and not bottom plate attachment for shear and/or uplift. Shear and uplift forces approach the unadjusted factored shear resistance of the perforated shear wall segment as the shear load approaches the shear resistance of the perforated shear wall. A continuous load path to the foundation based on this requirement and consideration of other forces (for example, from the story above) shall be maintained. The magnitude of shear and uplift varies as a function of overturning restraint provided and aspect ratio of the shear wall segment.

Uplift anchorage at perforated shear wall ends. Anchorage for uplift forces due to overturning are required at each end of the perforated shear wall. A continuous load path to the foundation based on this requirement and consideration of other forces (for example, from the story above) shall be maintained. In addition, compression chords of perforated shear wall segments are required to transmit compression forces equal to the required tension chord uplift force.

PSW Anchorage for in-plane shear. It is required that fastening be provided along the length of the sill plate of wall sections sheathed full-height to resist distributed shear, v , and uplift, t , forces. The resistance required for the shear connection is the average shear over the perforated shear wall segments, divided by the adjustment factor. This resistance will approach the unadjusted factored shear resistance of the wall as the shear wall demand approaches the maximum resistance. This shear fastening resistance conservatively accounts for the non-uniform distribution of shear within a perforated shear wall, since it represents the shear that can only be achieved when full overturning restraint is provided.

Provisions require that distributed fastening for shear, v , and uplift, t , be provided over the length of full-height sheathed wall sections. With no other specific requirements, the fastening between the full height segments will be controlled by minimum construction fastening requirements. For bottom plates on wood platforms this would only require one 16-penny nail at 16 in. on center. In some cases, it may be preferable to extend a single bottom plate fastening schedule across the entire length of the perforated shear wall rather than to require multiple fastening schedules.

Uplift anchorage between perforated shear wall ends. The resistance required for distributed uplift anchorage, t , is the same as the required shear resistance, v . The adequacy of the distributed uplift anchorage can be demonstrated using principles of mechanics and recent testing that determined the capacity of shear wall segments without uplift anchorage. A 4-ft wide shear wall segment with distributed anchorage of the base plate in lieu of an uplift anchor device provided about 25 percent of the resistance of a segment with uplift anchorage; an 8-ft wide shear wall segment resisted about 45 percent. When these are combined with the resistance adjustment factors, overturning resistance based on the unadjusted factored shear resistance is adequate for perforated shear wall segments with full height openings on each side. Conceptually the required distributed uplift resistance is intended to provide the same resistance that anchor bolts spaced at 2 ft on center provided for tested assemblies. While in the tested assemblies the bottom plates were fastened down, for design it is equally acceptable to fasten down the studs with a strap or similar device, since the studs will in turn restrain the bottom plate.

PSW Load path. A continuous load path to the foundation is required for the uplift resistance, T ; the compression resistance, C ; the unit shear resistance, v ; and the unit uplift resistance, t . Consideration of accumulated forces (for example, from the stories above) is required. Where shear walls occur at the same location at each floor (stack), accumulation of forces is reasonably straightforward. Where shear walls do not stack, attention will need to be paid to maintaining a load path for tie-downs at each end of the perforated shear wall, for compression resistance at each end of each perforated shear wall segment, and for distributed forces v and t at each perforated shear wall segment. Where ends of shear perforated shear wall segments occur over beams or headers, the beam or header will need to be checked for the vertical tension and compression forces in addition to gravity forces. Where adequate collectors are provided at lower floor shear walls, the total shear wall load need only consider the average shear in the perforated shear wall segments above, and not the average shear divided by the adjustment factor.

Example 1 Perforated Shear Wall

Problem Description: The perforated shear wall illustrated in Figure C12.4-4 is sheathed with 15/32" wood structural panel with 10d common nails with 4 in. perimeter spacing. All full-height sheathed sections are 4 ft wide. The window opening is 4 ft high by 8 ft wide. The door opening is 6.67 ft high by 4 ft wide. Sheathing is provided above and below the window and above the door. The wall length and height are 24 ft and 8 ft, respectively. Tie-downs provide overturning restraint at the ends of the perforated shear wall and anchor bolts are used to restrain the wall against shear and uplift between perforated shear wall ends. Determine the shear resistance adjustment factor for this wall.

Solution: The wall defined in the problem description meets the application criteria outlined for the perforated shear wall design method. Tie-downs provide overturning restraint at perforated shear wall ends, and anchor bolts provide shear and uplift resistance between perforated shear wall ends. Perforated shear wall height, factored shear resistances for the wood structural panel shear wall, and aspect ratio of full height sheathing at perforated shear wall ends meet requirements of the perforated shear wall method.

The process of determining the shear resistance adjustment factor involves determining percent full-height sheathing and maximum opening height ratio. Once these are known, a shear resistance adjustment factor can be determined from tabulated reduction factors.

From the problem description and Figure C12.3-4:

Percent full-height sheathing

$$= \frac{\text{Sum of perforated shear wall segment widths, } \Sigma L}{\text{Length of perforated shear wall, } L}$$

$$= \frac{4 \text{ ft} + 4 \text{ ft} + 4 \text{ ft}}{24 \text{ ft}} \times 100 = 50\%$$

Maximum opening height ratio

$$= \frac{\text{Maximum opening height}}{\text{Wall height, } h}$$

$$= \frac{6.67 \text{ ft}}{8 \text{ ft}} = \frac{5}{6}$$

For a maximum opening height ratio of 5/6 (or maximum opening height of 6.67 ft when wall height, h , equals 8 ft) and percent full-height sheathing equal to 50 percent, a shear resistance adjustment factor of $C_o = 0.57$ is obtained.

Note that if wood structural panel sheathing were not provided above and below the window or above the door the maximum opening height would equal the wall height, h .

Example 2 Perforated Shear Wall

Problem description. Figure C12.4-6 illustrates one face of a 2-story building with the first and second floor walls designed as perforated shear walls. Window heights are 4 ft and door height is 6.67 ft. A trial design is performed in this example based on applied loads, V . For simplification, dead load contribution to overturning and uplift restraint is ignored and the effective width for shear in each perforated shear wall segment is assumed to be the sheathed width. Framing is Douglas fir. After basic perforated shear wall resistance and force requirements are calculated, detailing options to provide for adequate unit shear, v , and unit uplift, t , transfer between perforated shear wall ends are covered. Figure C12.3-7 illustrates possible methods for achieving the required unit shear and uplift transfer. Configuration A considers the condition where a continuous rim joist is present at the second floor. Configuration B considers the case where a continuous rim joist is not provided, as when floor framing runs perpendicular to the perforated shear wall with blocking between floor framing members.

Perforated shear wall resistance and force requirements:

Second floor wall. Determine wood structural panel sheathing thickness and fastener schedule needed to resist applied load, $V = 2.25$ kips, from the roof diaphragm such that the shear resistance of the perforated shear wall is greater than the applied force. Also determine anchorage and load path requirements for uplift force at ends, in plane shear, uplift between wall ends, and compression.

$$\text{Percent full-height sheathing} = \frac{4 \text{ ft} + 4 \text{ ft}}{16 \text{ ft}} \times 100 = 50\%$$

$$\text{Maximum opening height ratio} = \frac{4 \text{ ft}}{8 \text{ ft}} = \frac{1}{2}$$

Shear resistance adjustment factor, $C_0 = 0.80$

Try 15/32 in. rated sheathing with 8d common nails (0.131 by 2-1/2 in.) at 6 in. perimeter spacing.

Unadjusted shear resistance (LRFD) = 0.36 klf

Adjusted shear resistance

$$= (\text{unadjusted shear resistance})(C_0)$$

$$= (0.36 \text{ klf})(0.80) = 0.288 \text{ klf}$$

Perforated shear wall resistance

$$= (\text{Adjusted Shear Resistance})(\Sigma L_i)$$

$$= (0.288 \text{ klf})(4 \text{ ft} + 4 \text{ ft}) = 2.304 \text{ kips}$$

$$2.304 \text{ kips} > 2.25 \text{ kips}$$

✓ OK

Required resistance due to story shear forces, V :

Overturning at shear wall ends, T :

$$T = \frac{Vh}{C_0 \Sigma L_i} = \frac{2.250 \text{ kips} (8 \text{ ft})}{0.80 (4 \text{ ft} + 4 \text{ ft})} = 2.813 \text{ kips}$$

In-plane shear, v :

$$v = \frac{V}{C_0 \Sigma L_i} = \frac{2.250 \text{ kips}}{0.80 (4 \text{ ft} + 4 \text{ ft})} = 0.352 \text{ klf}$$

Uplift, t , between wall ends: $t = v = 0.352 \text{ klf}$

Compression chord force, C , at each end of each perforated shear wall segment:

$$C = T = 2.813 \text{ kips}$$

First floor wall. Determine wood structural panel sheathing thickness and fastener schedule needed to resist applied load, $V = 2.60$ kips, at the second floor diaphragm such that the shear resistance of the perforated shear wall is greater than the applied force. Also determine anchorage and load path requirements for uplift force at ends, in-plane shear, uplift between wall ends, and compression.

$$\text{Percent full-height sheathing} = \frac{4 \text{ ft} + 4 \text{ ft}}{12 \text{ ft}} \times 100 = 67\%$$

Shear resistance adjustment factor, $C_0 = 0.67$

Unadjusted shear resistance (LRFD) = 0.49 klf

Adjusted shear resistance

$$= (\text{Unadjusted Shear Resistance})(C_0)$$

$$= (0.49 \text{ klf})(0.67) = 0.328 \text{ klf}$$

Perforated shear wall resistance

$$= (\text{Adjusted Shear Resistance})(\Sigma L_i)$$

$$= (0.328 \text{ klf})(4 \text{ ft} + 4 \text{ ft}) = 2.626 \text{ kips}$$

$$2.626 \text{ kips} > 2.600 \text{ kips}$$

✓ OK

Required resistance due to story shear forces, V :

Overturning at shear wall ends, T :

$$T = \frac{Vh}{C_0 \Sigma L_i} = \frac{2.600 \text{ kips} (8 \text{ ft})}{0.67 (4 \text{ ft} + 4 \text{ ft})} = 3.880 \text{ kips}$$

When maintaining load path from story above,

$$T = T \text{ from second floor} + T \text{ from first floor} \\ = 2.813 \text{ kips} + 3.880 \text{ kips} = 6.693 \text{ kips}$$

In-plane shear, v :

$$v = \frac{V}{C_0 \Sigma L_i} = \frac{2.600 \text{ kips}}{0.67 (4 \text{ ft} + 4 \text{ ft})} = 0.485 \text{ klf}$$

Uplift, t , between wall ends:

$$t = v = 0.485 \text{ klf}$$

Uplift, t , can be cumulative with 0.352 klf from story above to maintain load path. Whether this occurs depends on detailing for transfer of uplift forces between end walls.

Compression chord force, C , at each end of each perforated shear wall segment:

$$C = T = 3.880 \text{ kips}$$

When maintaining load path from story above, $C = 3.880 \text{ kips} + 2.813 \text{ kips} = 6.693 \text{ kips}$.

Tie-downs and posts and the ends of perforated shear wall are sized using calculated force, T . The compressive force, C , is used to size compression chords as columns and ensure adequate bearing.

Configuration A – Continuous Rim Joist (see Figure C12.3-7)

Second floor. Determine fastener schedule for shear and uplift attachment between perforated shear wall ends. Recall that $v = t = 0.352 \text{ klf}$.

Wall bottom plate (1 1/2 in. thickness) to rim joist. Use 20d box nail (0.148 by 4 in.). Lateral resistance $\phi\lambda Z' = 0.254 \text{ kips per nail}$ and withdrawal resistance $\phi\lambda W' = 0.155 \text{ kips per nail}$.

Nails for shear transfer

$$= (\text{shear force, } v) / \phi\lambda Z' \\ = 0.352 \text{ klf} / 0.254 \text{ kips per nail} \\ = 1.39 \text{ nails per foot}$$

Nails for uplift transfer

$$= (\text{uplift force, } t) / \phi\lambda W'$$

$$= 0.352 \text{ klf} / 0.155 \text{ kips per nail}$$

$$= 2.27 \text{ nails per foot}$$

Net spacing for shear and uplift

$$= 3.3 \text{ inches on center}$$

Rim joist to wall top plate. Use 8d box nails (0.113 by 2-1/2 in.) toe-nailed to provide shear transfer. Lateral resistance $\phi\lambda Z' = 0.129 \text{ kips per nail}$.

Nails for shear transfer

$$= (\text{shear force, } v) / \phi\lambda Z' \\ = 0.352 \text{ klf} / 0.129 \text{ kips per nail} \\ = 2.73 \text{ nails per foot}$$

Net spacing for shear

$$= 4.4 \text{ inches on center}$$

See detail in Figure C12.3-7 for alternate means a shear transfer (such as a metal angle or plate connector).

Transfer of uplift, t , from second floor in this example is accomplished through attachment of second floor wall to the continuous rim joist which has been designed to provide sufficient strength to resist the induced moments and shears. Continuity of load path is provided by tie-downs at the ends of the perforated shear wall.

First floor. Determine anchorage for shear and uplift attachment between perforated shear wall ends. Recall that $v = t = 0.485 \text{ klf}$.

Wall bottom plate (1 1/2 in. thickness) to concrete. Use 1/2 in. anchor bolt with lateral resistance $\phi\lambda Z' = 1.34 \text{ kips}$.

Bolts for shear transfer

$$= (\text{shear force, } v) / \phi\lambda Z' \\ = 0.485 \text{ klf} / 1.34 \text{ kips per bolt} \\ = 0.36 \text{ bolts per ft}$$

Net spacing for shear

$$= 33 \text{ in. on center}$$

Bolts for uplift transfer. Check axial capacity of bolts for $t = v = 0.485 \text{ klf}$ and size plate washers accordingly. No interaction between axial and lateral load on anchor bolt is assumed (that is, the presence of axial tension is assumed not to affect lateral strength).

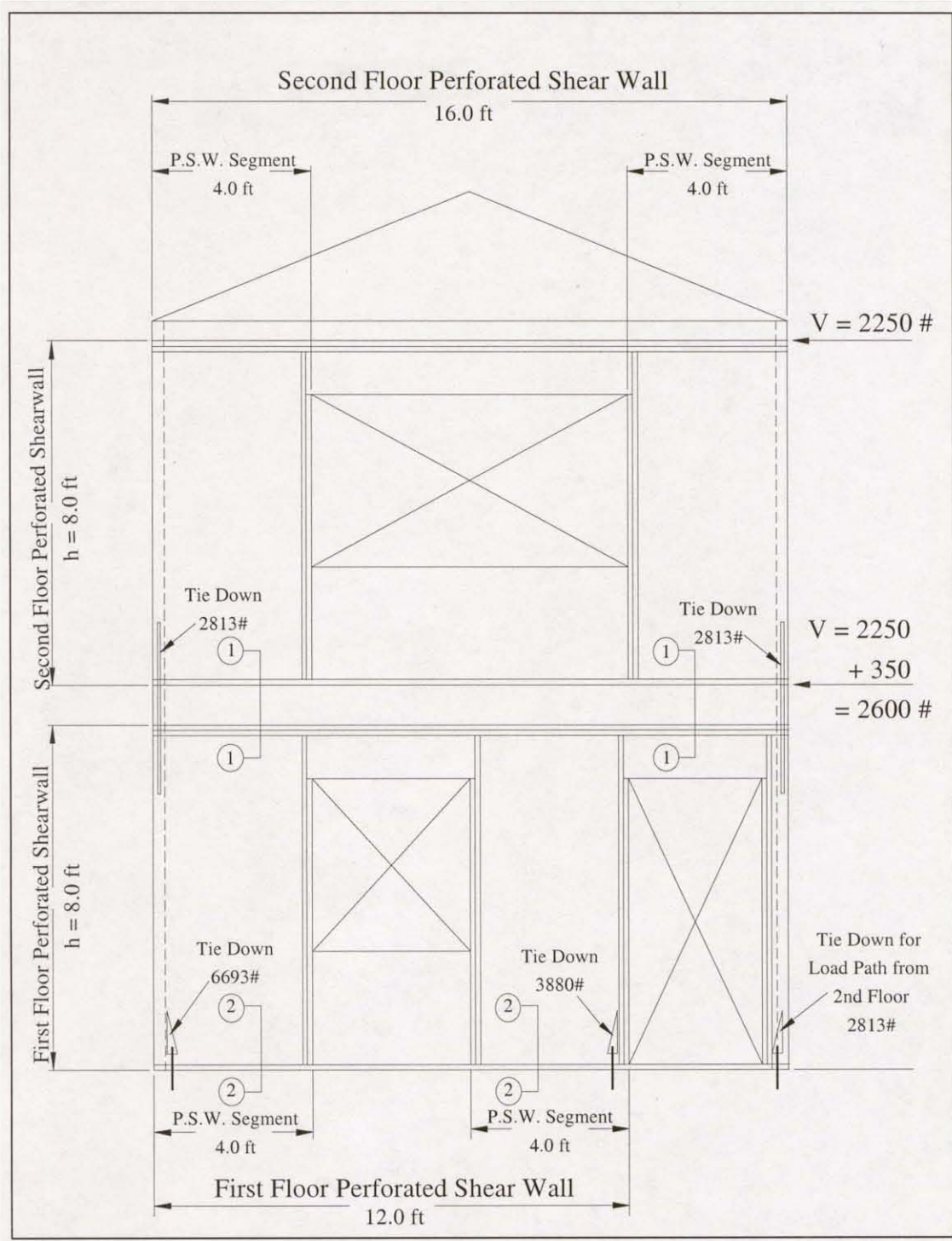

Figure C12.3-6 Elevation for perforated shear wall Example 2.

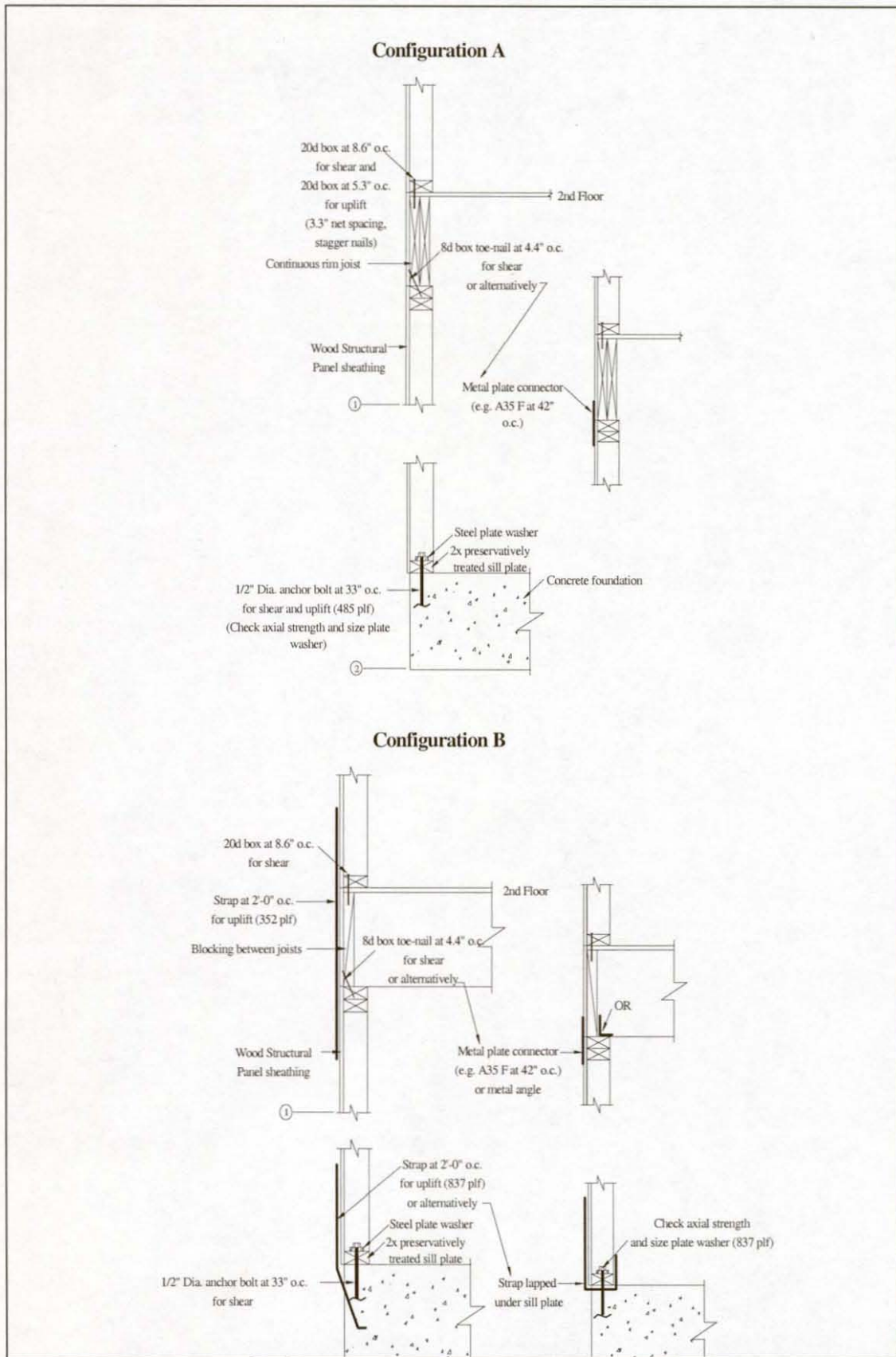

Figure C12.3-7 Details for perforated shear wall Example 2.

12.3.1 Framing. All framing that is designed as part of an engineered wood structure must be designed with connectors that are able to transfer the required forces between various components. These connectors can be either proprietary hardware or some of the more conventional connections used in wood construction. However, these connectors should be designed according to accepted engineering practice to ensure that they will have the capacity to resist the forces. The requirement of columns and posts being framed to full end bearing requires that the force transfer from the column to the base be accomplished through end grain bearing of the wood, not through placing the bolts or other connectors in shear. This requirement is included to ensure adequate capacity for transfer of the vertical forces due to both gravity and overturning moment. Alternatively, the connection can be designed to transfer the full loading through placing the bolts or other connectors in shear neglecting all possible bearing.

The anchorage connections used in engineered wood construction must be capable of resisting the forces that will occur between adjacent members (beams and columns) and elements (diaphragms and shear walls). These connections can utilize proprietary hardware or be designed in accordance with principles of mechanics. Inadequate connections are often the cause of structural failures in wood structures, and the registered design professional is cautioned to use conservative values for allowable capacities since most published values are based on monotonic, not cyclic, load applications (U.S. Department of Agriculture, National Oceanic and Atmospheric Administration, 1971). Testing has shown that some one-sided bolted connections subject to cyclic loading, such as tie-down devices, do not perform well. This was substantiated by the poor performance of various wood frame elements in structures in the January 1994 Northridge earthquake.

Concrete or masonry wall anchorages using toe nails or nails subject to withdrawal are prohibited by the *Provisions*. It has been shown that these types of connections are inadequate and do not perform well (U.S. Department of Agriculture, National Oceanic and Atmospheric Administration, 1971). Ledgers subjected to cross-grain bending or tension perpendicular to grain also have performed poorly in past earthquakes, and their use is now prohibited by the *Provisions*.

12.4 CONVENTIONAL LIGHT-FRAME CONSTRUCTION

The *Provisions* intend that a structure using conventional construction methods and complying with the requirements of this section be deemed capable of resisting the seismic forces imposed by the *Provisions*.

Repetitive framing members such as joists, rafters, and studs together with sheathing and finishes comprise conventional light-frame construction. The subject of conventional construction is addressed in each of the model codes. It is acknowledged and accepted that, for the most part, the conventional construction provisions in the model codes concerning framing members and sheathing that carry gravity loads are adequate. This is due to the fact that the tables in the model codes giving allowable spans have been developed using basic principles of mechanics. For seismic lateral force resistance, however, experience has shown that additional requirements are needed.

To provide lateral force resistance in vertical elements of structures, wall bracing requirements have been incorporated in conventional construction provisions of the model codes. With a few exceptions, these generally have been adequate for single family residences for which conventional construction requirements were originally developed. While the model building codes have been quite specific as to the type of bracing materials to be used and the amount of bracing required in any wall, no limits on the number or maximum separation between braced walls have been established. This section of the *Provisions* introduces the concept of mandating the maximum spacing of braced wall lines. By mandating the maximum spacing of braced wall lines and thereby limiting the lateral forces acting on these vertical elements, these revisions provide for a seismic-force-resisting system that will be less prone to overstressing and the requirements can be applied and enforced more uniformly than previous model building code requirements. While specific elements of light-frame construction may be calculated to be overstressed, there is typically a great deal of redundancy and uncounted resistance in such structures and they have generally performed well in past earthquakes. The experience in the

Northridge earthquake was, however, less reassuring, especially for those residences relying on gypsum board or stucco for lateral force resistance. The light weight of conventional construction, together with the large energy dissipation capacity of the multiple fasteners used and inherent redundancy of the system are major factors in the observed good performance where wood or wood-based panels were used.

12.4.1 Limitations

12.4.1.1 General. The scope of this section specifically excludes prescriptive design of structures with concrete or masonry walls above the basement story, with the exception of veneer, in order to maintain the light weight of construction that the bracing requirements are based on. Wood braced wall panels and diaphragms as prescribed in this section are not intended to support lateral forces due to masonry or concrete construction. Prescriptive (empirical) design of masonry walls is allowed for in Chapter 11; however, design of structures combining masonry wall construction and wood roof and floor diaphragm construction must have an engineered design. In regions of high seismic activity, past earthquakes have demonstrated significant problems with structures combining masonry and wood construction. While engineered design requirements do address these problems, the prescriptive requirements in the model codes do not adequately address these problems. Masonry and concrete basement walls are permitted to be constructed in accordance with the requirements of the IRC.

12.4.1.2 Irregular structures. This section was added to the 1997 *Provisions* to clarify the definition of irregular (unusually shaped) structures that would require the structure to be designed for the forces prescribed in Chapter 5 in accordance with the requirements of Sec. 12.3 and 12.4. The descriptions and diagrams provide the registered design professional with several typical irregularities that produce torsional response, or result in forces considered high enough to require an engineered design and apply only to structures assigned to Seismic Design Category C or D.

Structures with geometric discontinuities in the lateral-force-resisting system have been observed to sustain more earthquake and wind damage than structures without discontinuities. They have also been observed to concentrate damage at the discontinuity location. For Seismic Design Categories C and D, this section translates applicable irregularities from Tables 4.3-2 and 4.3-3 into limitations on conventional light-frame construction. If the described irregularities apply to a given structure, it is required that either the entire structure or the non-conventional portions be engineered in accordance with the engineered design portions of the *Provisions*. The irregularities are based on similar model code requirements. While conceptually these are equally applicable to all seismic design categories, they are more readily accepted in areas of high seismic risk, where damage due to irregularities has been observed repeatedly.

Application of engineered design to non-conventional portions rather than to the entire structure is a common practice in some regions. The registered design professional is left to judge the extent of the portion to be designed. This often involves design of the nonconforming element, force transfer into the element, and a load path from the element to the foundation. A nonconforming portion will sometimes have enough of an impact on the behavior of a structure to warrant that the entire seismic-force-resisting system receives an engineered design.

12.4.1.2.1 Out-of-plane offset. This limitation is based on Item 4 of Table 4.3-2 and applies when braced wall panels are offset out-of-plane from floor to floor. In-plane offsets are discussed in another item. Ideally braced wall panels would always stack above of each other from floor to floor with the length stepping down at upper floors as less length of bracing is required.

Because cantilevers and set backs are very often incorporated into residential construction, the exception offers rules by which limited cantilevers and setbacks can be considered conventional. Floor joists are limited to 2 by 10 (actual: 12 by 93 in.; 38 by 235 mm) or larger and doubled at braced wall panel ends in order to accommodate the vertical overturning reactions at the end of braced wall panels. In addition the ends of cantilevers are attached to a common rim joist to allow for redistribution of load. For rim joists that cannot run the entire length of the cantilever, the metal tie is

intended to transfer vertical shear as well as to provide a nominal tension tie. Limitations are placed on gravity loads to be carried by cantilever or setback floor joists so that the joist strength will not be exceeded. The roof loads discussed are based on the use of solid sawn members where allowable spans limit the possible loads. Where engineered framing members such as trusses are used, gravity load capacity of the cantilevered or setback floor joists should be carefully evaluated.

12.4.1.2.2 Unsupported diaphragm. This limitation is based in Item 1 of Table 4.3-2, and applies to open-front structures or portions of structures. The conventional construction bracing concept is based on using braced wall lines to divide a structure up into a series of boxes of limited dimension, with the seismic force to each box being limited by the size. The intent is that each box be supported by braced wall lines on all four sides, limiting the amount of torsion that can occur. The exception, which permits portions of roofs or floors to extend past the braced wall line, is intended to permit construction such as porch roofs and bay windows. Walls for which lateral resistance is neglected are allowed in areas where braced walls are not provided.

12.4.1.2.3 Opening in wall below. This limitation is based on Item 4 of Table 4.3-3 and applies when braced wall panels are offset in-plane. Ends of braced wall panels supported on window or door headers can be calculated to transfer large vertical reactions to headers that may not be of adequate size to resist these reactions. The exception permits a 1 ft extension of the braced wall panel over a 4 by 12 (actual: 32 by 113 in.; 89 by 286 mm) header on the basis that the vertical reaction is within a 45 degree line of the header support and therefore will not result in critical shear or flexure. All other header conditions require an engineered design. Walls for which lateral resistance is neglected are allowed in areas where braced walls are not provided.

12.4.1.2.4 Vertical offset in diaphragm. This limitation results from observation of damage that is somewhat unique to split-level wood frame construction. If floors on either side of an offset move in opposite directions due to earthquake or wind loading, the short bearing wall in the middle becomes unstable and vertical support for the upper joists can be lost, resulting in a collapse. If the vertical offset is limited to a dimension equal to or less than the joist depth, then a simple strap tie directly connecting joists on different levels can be provided, eliminating the irregularity. The IRC, Sec. 502.6.1, provides requirements for tying of floor joists.

12.4.1.2.5 Non-perpendicular walls. This limitation is based on Item 5 of Table 4.3-2 and applies to nonperpendicular braced wall lines. When braced wall lines are not perpendicular to each other, further evaluation is needed to determine force distributions and required bracing.

12.4.1.2.6 Large diaphragm opening. This limitation is based on Item 3 of Table 4.3-2 and attempts to place a practical limit on openings in floors and roofs. Because stair openings are essential to residential construction and have long been used without any report of life-safety hazards resulting, these are felt to be acceptable conventional construction. See Sec. 12.4.3.7 for detailing requirements for permitted openings.

12.4.1.2.7 Stepped foundation. This limits a condition that can cause a torsional irregularity per Item 1 of Table 4.3-2. Where heights of braced wall panels vary significantly, distribution of lateral forces will also vary. If a structure on a hill is supported on 2-ft-high, braced cripple wall panels on one side and 8-ft-high panels on the other, torsion and redistribution of forces will occur. An engineered design for this situation is required in order to evaluate force distribution and provide adequate wall bracing and anchor bolting. This limitation applies specifically to walls from the foundation to the floor. While gable-end walls have similar variations in wall heights, this has not been observed to be a significant concern in conventional construction. See Sec. 12.4.3.6 for detailing requirements for permitted foundation stepping.

12.4.2 Braced walls

12.4.2.1 Spacing between braced wall lines. Table 12.4-1 prescribes the spacing of braced wall lines and number of stories permitted for conventional construction structures. Figures C12.4-1 and C12.4-

2 illustrate the basic components of the lateral bracing system. Information in Tables 12.4-1 and 12.4-2 was first included in the 1991 *Provisions*.

12.4.2.2 Braced wall line sheathing. Table 12.4-2 prescribes the minimum length of bracing along each 25 ft (7.6 m) length of braced wall line. Total height of structures has been reduced to limit overturning of the braced walls so that significant uplift is not generally encountered. The height limit will accommodate 8 to 10 ft (2.4 to 3 m) story heights.

12.4.3 Detailing requirements. The intent of this section is to rely on the traditional light-frame conventional construction materials and fastenings as prescribed in the references for this chapter. Braced wall panels are not required to be aligned vertically or horizontally (within the limits prescribed in Sec. 12.4.1) but stacking is desirable where possible. With the freedom provided for non-alignment it becomes important that a load path be provided to transfer lateral forces from upper levels through intermediate vertical and horizontal resisting elements to the foundation. Connections between horizontal and vertical resisting elements are prescribed. In structures two or three stories in height, it is desirable to have interior braced wall panels supported on a continuous foundation. See Figures C12.4-3 through C12.4-13 for examples of connections.

The 1997 *Provisions* incorporated some of the wall anchorage, top plate, and braced wall panel connection requirements from the model building codes. These are included for completeness of the document and to clarify the requirement for the registered design professional. Additional requirements for foundations supporting braced wall panels has also been added to provide guidance and clarity for the registered design professional.

SEISMIC PERFORMANCE CATEGORY	MAXIMUM WALL SPACING (FEET) *
C,D AND E	25
B	35
A	NOT REQUIRED

* REFER TO TABLE 12.4-2 FOR MINIMUM LENGTH OF WALL BRACING

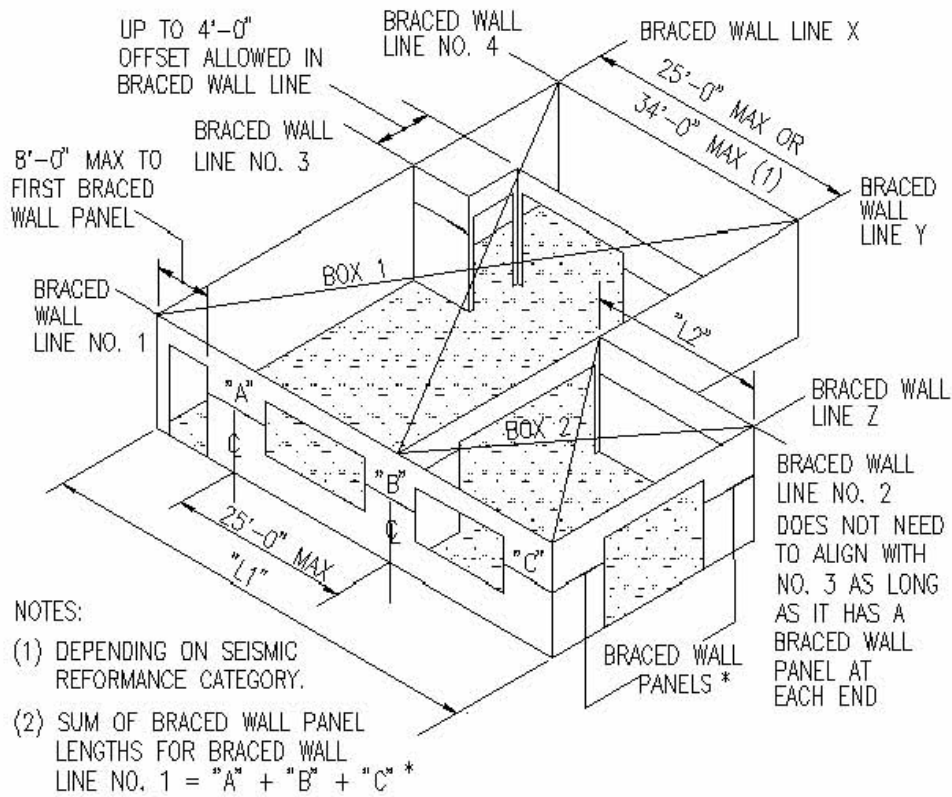

Figure C12.4-1 Acceptable one-story bracing example.

SEISMIC PERFORMANCE CATEGORY	MAXIMUM WALL SPACING (FEET) *
C AND D	25
B	35
A	NOT REQUIRED

*REFER TO TABLE 124-2 FOR MINIMUM LENGTH OF WALL BRACING

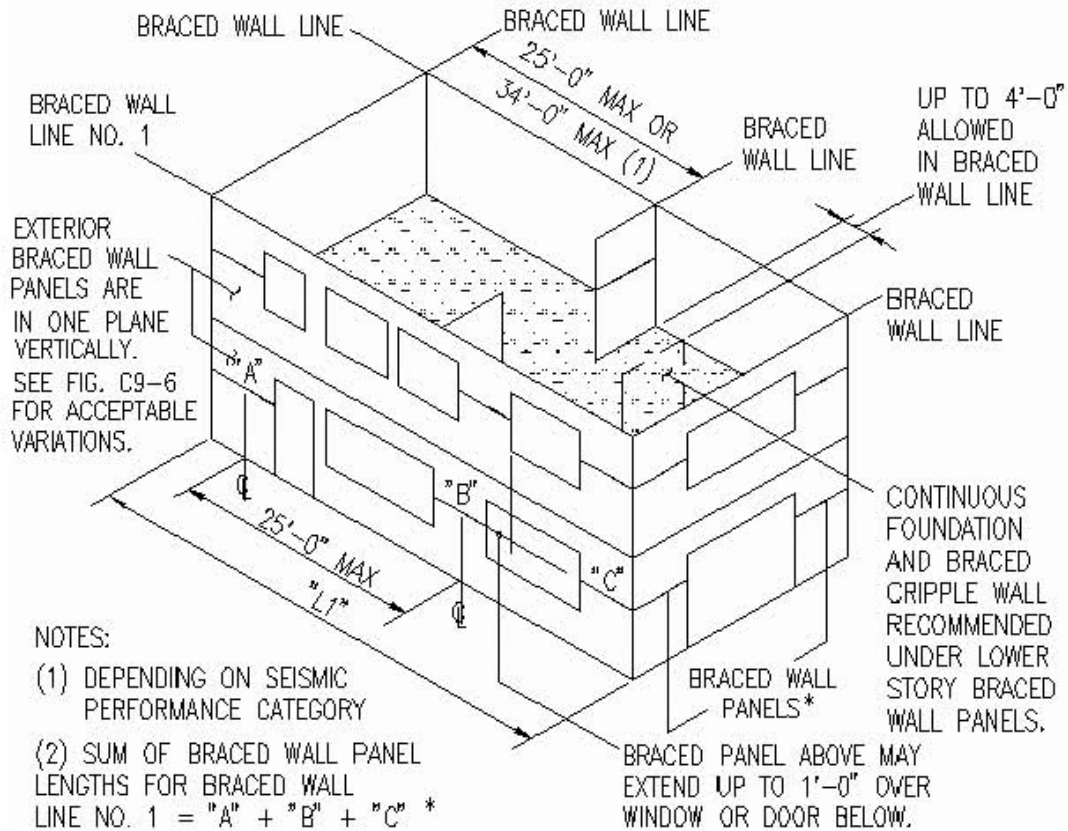
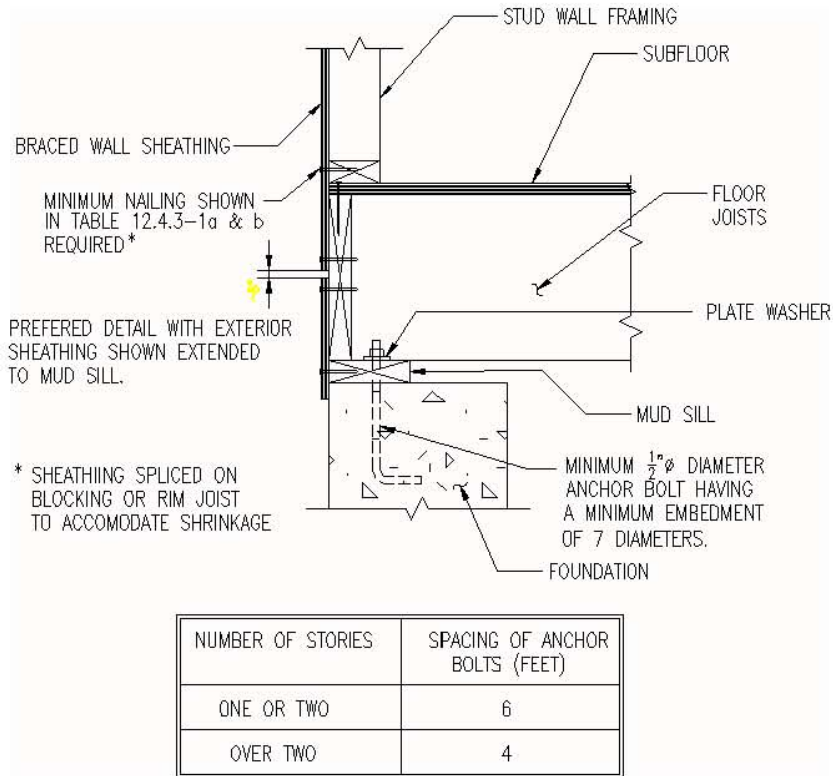

Figure C12.4-2 Acceptable two-story bracing example.



NUMBER OF STORIES	SPACING OF ANCHOR BOLTS (FEET)
ONE OR TWO	6
OVER TWO	4

Figure C12.4-3 Wall anchor detail.

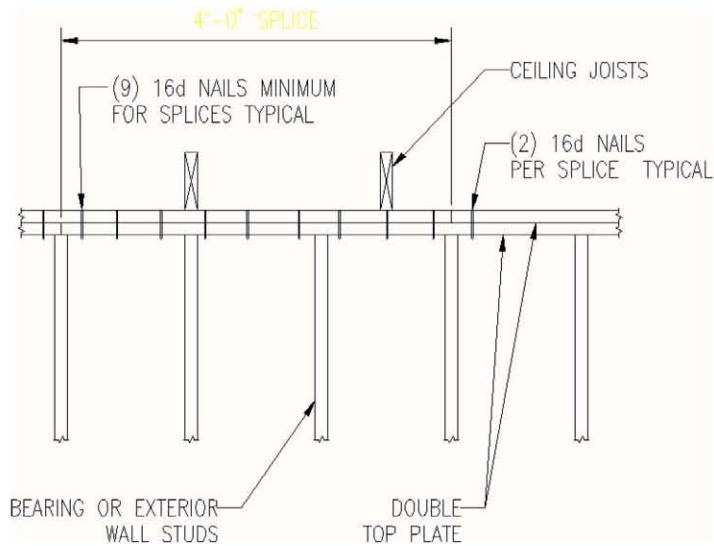

Figure C12.4-4 Double top splice.

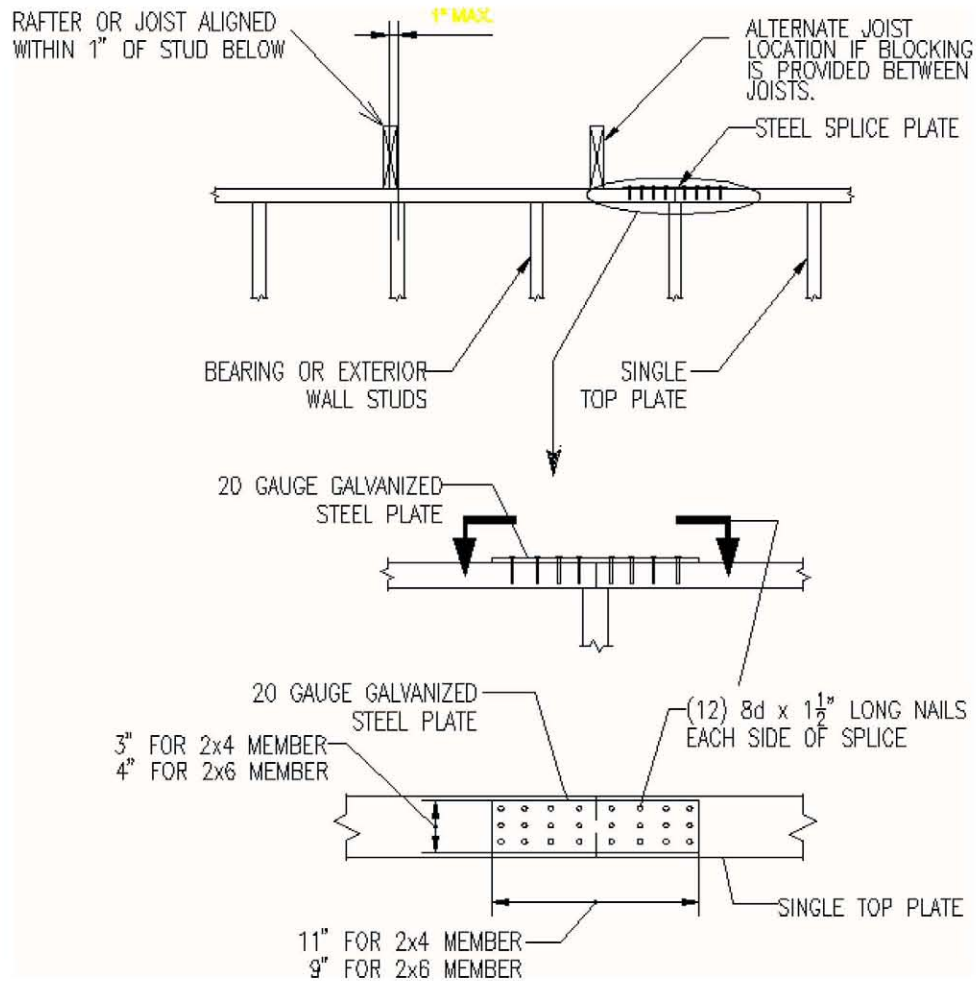

Figure C12.4-5 Single top splice.

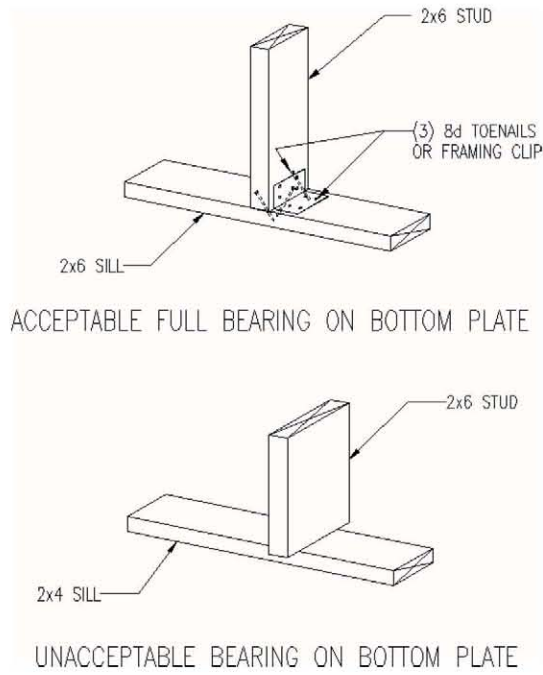

Figure C12.4-6 Full bearing bottom plate.

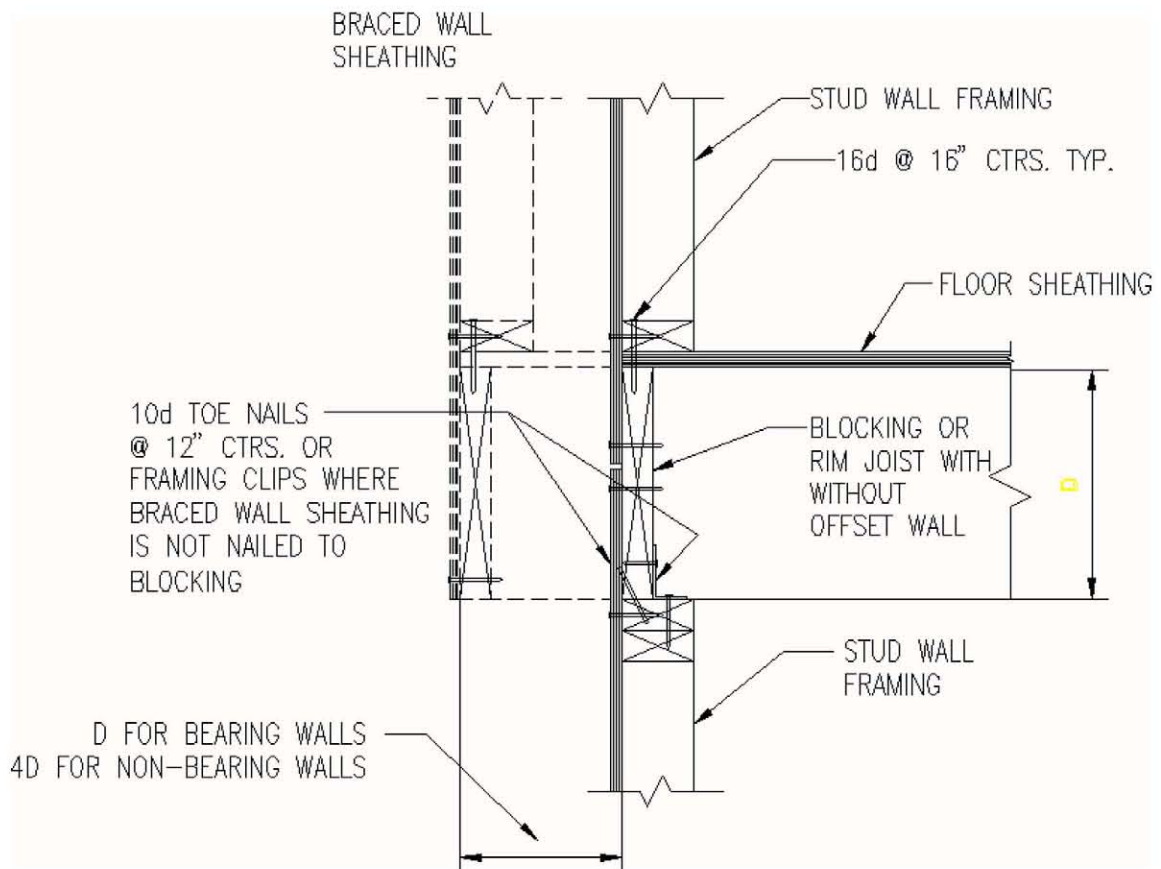

Figure C12.4-7 Exterior braced wall.

Figure C12.4-8 Interior braced wall at perpendicular joist.

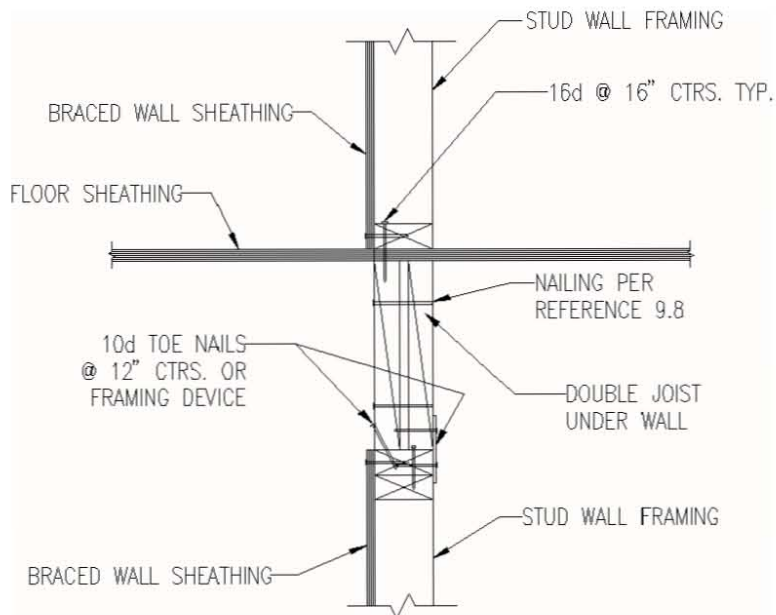

Figure C12.4-9 Interior braced wall at parallel joist.

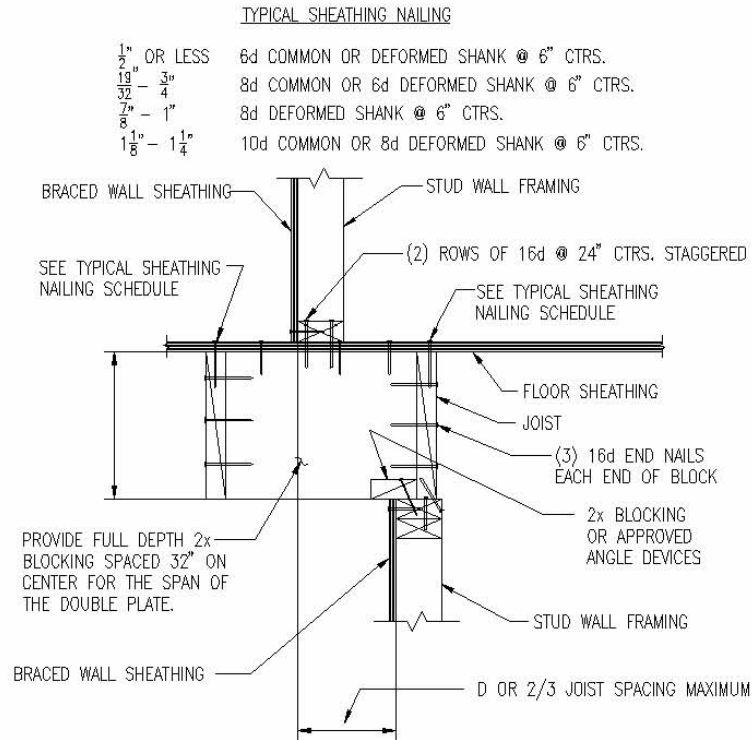

Figure C12.4-10 Offset at interior braced wall.

TYPICAL SHEATHING NAILING

$\frac{1}{2}$ " OR LESS	6d COMMON OR DEFORMED SHANK @ 6" CTRS.
$\frac{19}{32}$ " - $\frac{3}{4}$ "	8d COMMON OR 6d DEFORMED SHANK @ 6" CTRS.
$\frac{7}{8}$ " - 1"	8d DEFORMED SHANK @ 6" CTRS.
$1\frac{1}{8}$ " - $1\frac{1}{4}$ "	10d COMMON OR 8d DEFORMED SHANK @ 6" CTRS.

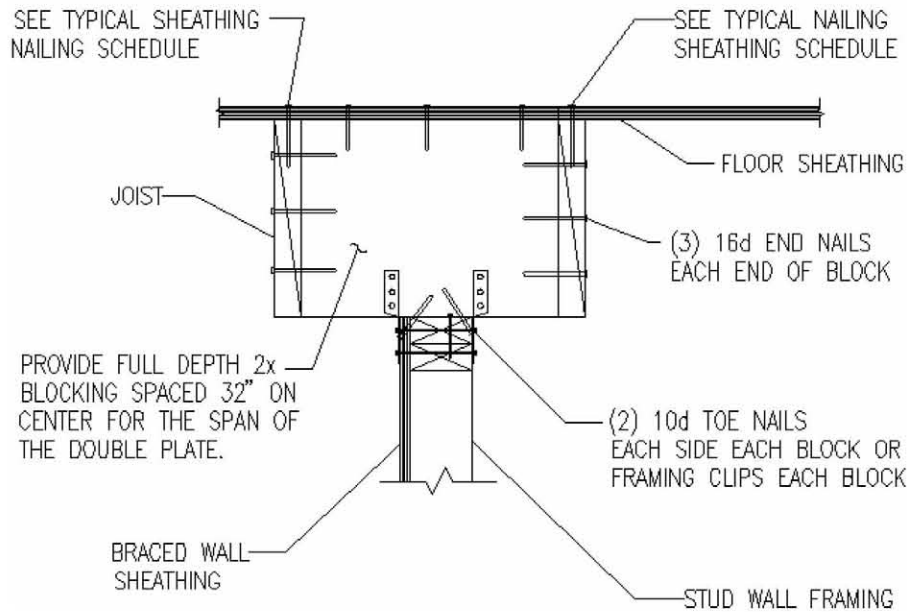

Figure C12.4-11 Diaphragm connection to braced wall below

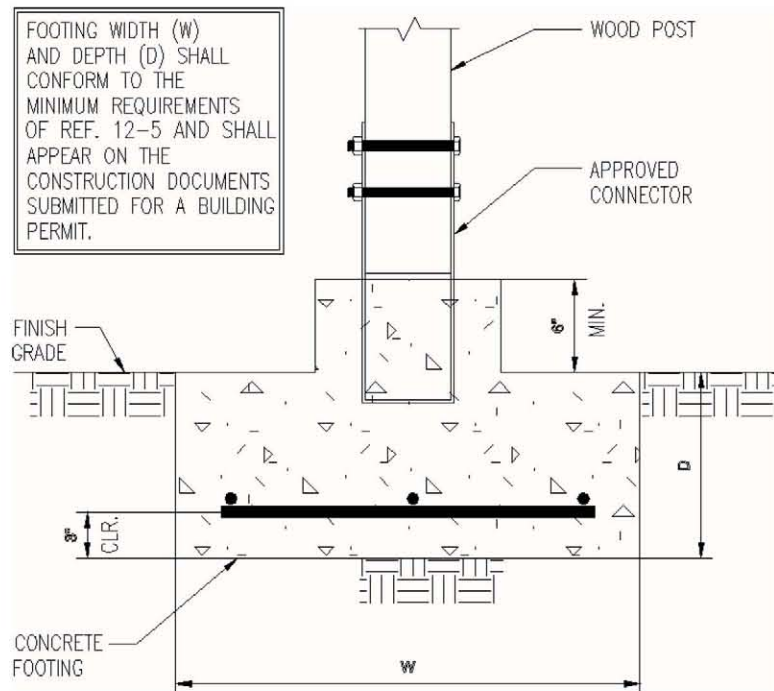

Figure C12.4-12 Post base detail.

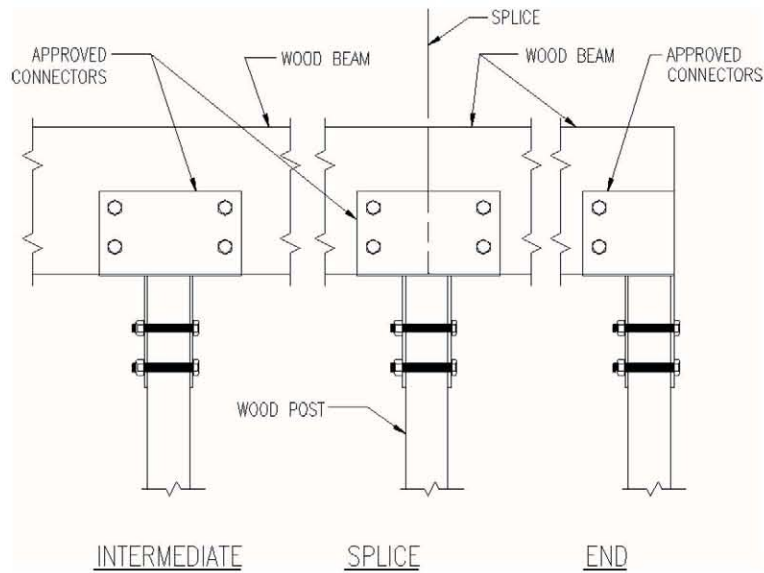

Figure C12.4-13 Wood beam connection to post.

12.4.3.4 Braced wall panel connections. The exception provided in this section of the *Provisions* is included due to the difficulty in providing a mechanism to transfer the diaphragm loads from a truss roof system to the braced wall panels of the top story. This problem has been considered by the Clackamas County, Oregon Building Codes Division, and an alternate to the CABO Building Code Sec. 402.10 was written in 1993, and revised September 5, 1995. The details shown in Figure C12.4-14 through C12.4-17 are provided as suggested methods for providing positive transfer of the lateral forces from the diaphragm through the web sections of the trusses to the top of the braced wall panels below.

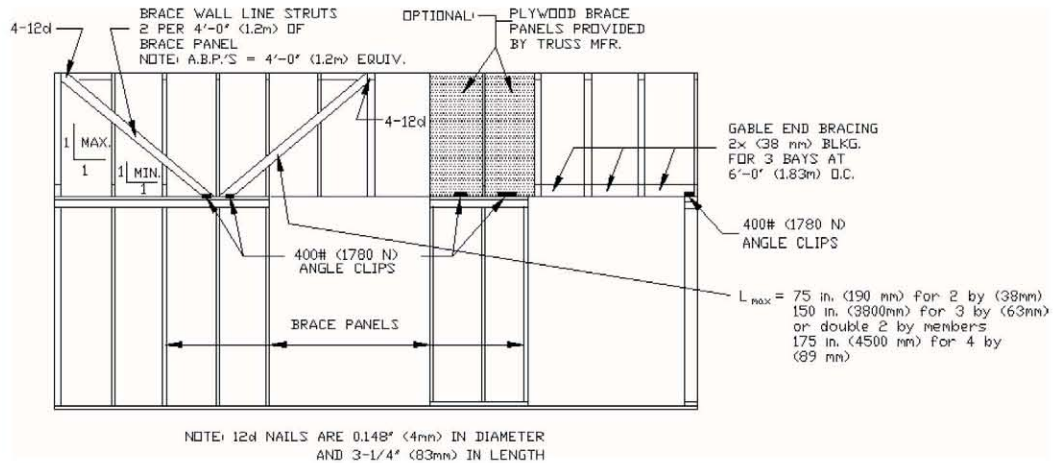

Figure C12.4-14 Suggested methods for transferring roof diaphragm loads to braced wall panels.

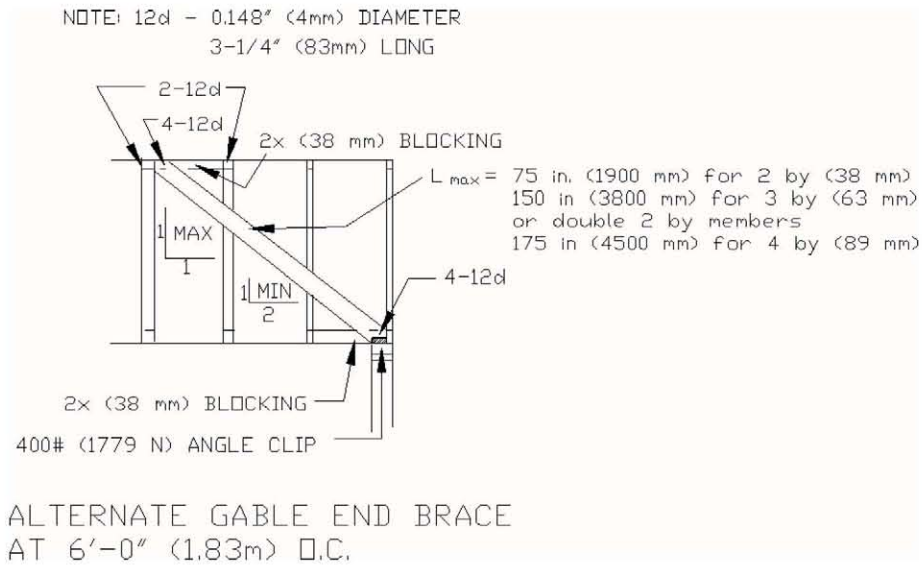

Figure C12.4-15 Alternate gable end brace.

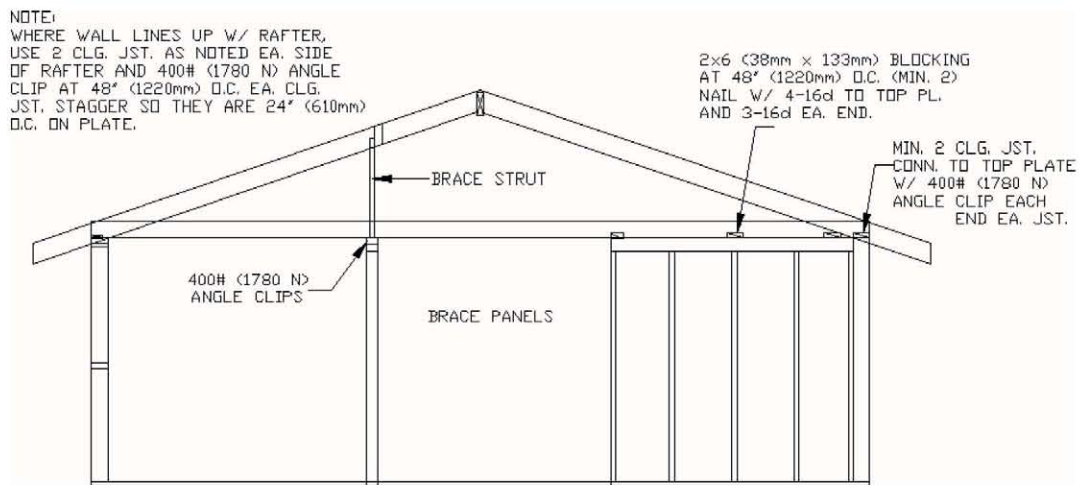

Figure C12.4-16 Wall parallel to truss bracing detail.

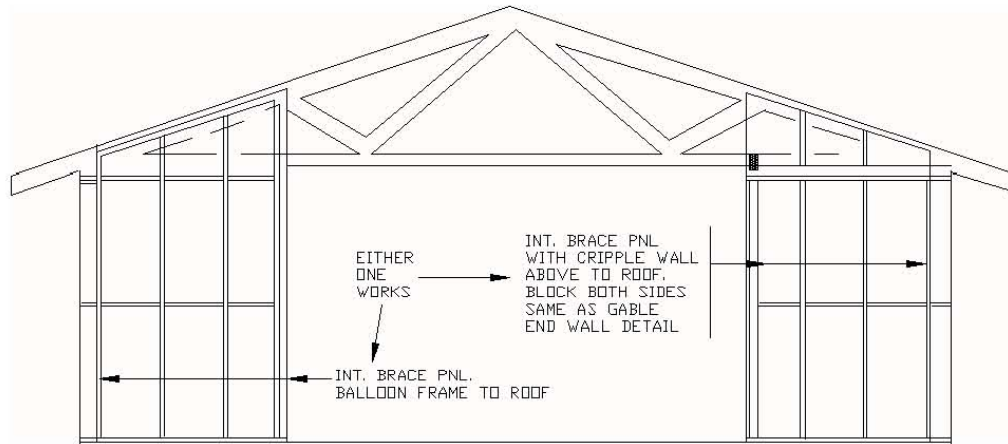

Figure C12.4-17 Wall parallel to truss alternate bracing detail.

REFERENCES

- American Institute of Timber Construction. 1994. *Timber Construction Manual*. New York, New York: John Wiley and Sons, Inc.
- American Forest & Paper Association. 1991. *ANSI/NFoPA NDS-1991. National Design Specification for Wood Construction*. Washington, D.C.: AF&PA.
- American Forest & Paper Association. 1996. *Manual of Wood Construction: Load and Resistance Factor Design (LRFD)*. Washington, D.C.: AF&PA.
- American Plywood Association. 1991. *Design/Construction Guide—Diaphragms*. Tacoma, Washington: APA.
- American Plywood Association. 1994. *Northridge California Earthquake, T94-5*. Tacoma, Washington.: APA.
- American Plywood Association. 1996. *Proposed Cyclic Testing Standard for Shear Walls*. Tacoma, Washington: APA.
- APA B The Engineered Wood Association. 1996. *Wood structural panel shear walls with gypsum wallboard and window/door openings*, Report 157. Tacoma, Washington: APA.
- ASCE Committee on Wood Load and Resistance Factor Design for Engineered Wood Construction. 1988. *A Pre Standard Report American Society of Civil Engineers*. New York, New York: ASCE.
- ASCE. 1995. *Standard For Load and Resistance Factor For Engineered Wood Construction*.
- AF&PA/ASCE 16-95. American Society of Civil Engineers, New York, New York.
- Applied Technology Council. 1981. *Guidelines for the Design of Horizontal Wood Diaphragms*, ATC-7. Redwood City, California: ATC.

- Applied Technology Council. 1995. *Cyclic Testing of Narrow Plywood Shear Walls*, ATC-R-1. Redwood City, California: ATC.
- Breyer, Donald E. 1993. *Design of Wood Structures*, Third Edition. New York, New York: McGraw-Hill Book Company.
- Canadian Wood Council. 1990. *Wood Design Manual*. Ottawa: Canadian Wood Council.
- Canadian Wood Council. 1991. *Wood Reference Handbook*. Ottawa: Canadian Wood Council.
- Council of American Building Officials (CABO). 1995. *One- and Two-Family Dwelling Code*. Country Club Hills, Illinois: BOCA
- Department of the Army, Navy and Air Force. 1992. *Seismic Design for Buildings*, TM5-809-10 (Tri-Services Manual). Washington, D.C.: U.S. Government Printing Office.
- Dolan, J.D., 1994. "Proposed Test Method for Dynamic Properties of Connections Assembled with Mechanical Fasteners." *ASTM Journal of Testing and Evaluation* 22(6):542-547.
- Dolan, J. D., and M. W. White. 1992. "Design Considerations for Using Adhesives in Shear Walls." *ASCE Journal of Structural Engineering* 118(12):3473-3480.
- Dolan, J. D. and Johnson, A. C. 1996. "Monotonic Tests of Long Shear Walls with Openings" Virginia Polytechnic Institute and State University, Timber Engineering Report No. TE-1996-001. Blacksburg, Virginia: VPISU.
- Dolan, J. D. and Johnson, A. C. 1996. "Cyclic Tests of Long Shear Walls with Openings" Virginia Polytechnic Institute and State University, Timber Engineering Report No. TE-1996-002. Blacksburg, Virginia: VPISU.
- Dolan, J. D., and C. P. Heine. 1997a. *Monotonic tests of wood-frame shear walls with various openings and base restraint configurations*, Timber Engineering Report TE-1997-001. Blacksburg: Virginia Polytechnic Institute and State University.
- Dolan, J. D., and C. P. Heine. 1997b. *Sequential phased displacement cyclic tests of wood-frame shear walls with various openings and base restraint configurations*, Timber Engineering Report TE-1997-002. Blacksburg: Virginia Polytechnic Institute and State University.
- Earthquake Engineering Research Institute. 1996. Northridge earthquake reconnaissance report, Chapter 6, Supplement C to Volume 11, pp. 125 et seq., *Earthquake Spectra*.
- Faherty, Keith F., and T. G. Williamson. 1989. *Wood Engineering and Construction Handbook*. New York, New York: McGraw-Hill.
- U.S. Department of Housing and Urban Development, 1984. *HUD Minimum Property Standards, Vol. I, II, and III*. Washington, D.C.: United States Government Printing Office.
- Forest Products Laboratory. 1986. *Wood: Engineering Design Concepts*. University Park: Materials Education Council, The Pennsylvania State University.
- Foschi, R. O., and A. Filiatrault. 1990. *Performance Evaluation of 3M Scotch Grip Wood Adhesive 5230 for the Static and Dynamic Design of Timber Shear Walls and Diaphragms*, Vancouver: Department of Civil Engineering Report, University of British Columbia.
- Goetz, Karl-Heinz, Dieter Hoor, Karl Moehler, and Julius Natterer. 1989. *Timber Design and Construction Source Book: A Comprehensive Guide to Methods and Practice*. New York, New York: McGraw-Hill.
- Hoyle and Woeste. 1989. *Wood Technology and Design of Structures*. Iowa State University Press.
- International Conference of Building Officials (ICBO). 1994. *Uniform Building Code*. Whittier, California: ICBO.

- Keenan, F. J. 1986. *Limit States Design of Wood Structures*. Morrison Hershfield Limited.
- NAHB Research Center. 1998. *The performance of shear walls with narrow wall segments, reduced based restraint, and alternative framing methods*. Upper Marlboro, Maryland.
- Rose, J. D., 1996. Research Report 158. "Preliminary Testing of Wood Structural Panel Shear Walls Under Cyclic (Reversed) Loading." Tacoma, Washington: APA.
- Sherwood and Stroh. 1989. "Wood-Frame House Construction" in *Agricultural Handbook 73*. Washington, D.C.: U.S. Government Printing Office.
- Somayaji, Shan. 1992. *Structural Wood Design*. St. Paul, Minnesota: West Publishing Co.
- Stalnaker, Judith J., and E. C. Harris. 1996. *Structural Design in Wood*, Second Edition. New York, New York: McGraw-Hill.
- Sugiyama, H. 1981. "The evaluation of shear strength of plywood-sheathed walls with openings," *Wood Industry*, 36-7, July.
- Sugiyama, H., and T. Matsumoto. 1994. "Empirical equations for the estimation of racking strength of plywood-sheathed shear wall with openings," in *Summaries of Technical Papers of Annual Meeting*, Architectural Institute of Japan, September.
- U.S. Department of Agriculture, National Oceanic and Atmospheric Administration. 1971. *San Fernando, California, Earthquake of February 9, 1971*. Washington, D.C.: NOAA.
- White, M. W. and J. D. Dolan, 1996. "Seismic Response of Timber Shear Walls. Part I: Aspect Ratios." Paper submitted for publication in *ASCE Journal of Structural Engineering*.
- Yasumura, M., and H. Sugiyama. 1984. "Shear properties of plywood-sheathed wall panels with openings," in *Transaction of the Architectural Institute of Japan*, No. 338, April.
- Additional references are listed in John Peterson. 1983. "Bibliography on Lumber and Wood Panel Diaphragms," *Journal of Structural Engineering*, Vol. 109 No. 12. American Society of Civil Engineers, New York, New York.

This page is intentionally left blank.

Chapter 13 Commentary

SEISMICALLY ISOLATED STRUCTURE DESIGN REQUIREMENTS

13.1 GENERAL

Seismic isolation, commonly referred to as base isolation, is a design concept based on the premise that a structure can be substantially decoupled from potentially damaging earthquake motions. By substantially decoupling the structure from the ground motion, the level of response in the structure can be reduced significantly from the level that would otherwise occur in a conventional, fixed-base building.

The potential advantages of seismic isolation and the recent advancements in isolation-system products already have led to the design and construction of over 200 seismically isolated buildings and bridges in the United States. A significant amount of research, development, and application activity has occurred over the past 20 years. The following references provide a summary of some of the work that has been performed: Applied Technology Council (ATC, 1986, 1993, and 2002), ASCE Structures Congress (ASCE, 1989, 1991, 1993, and 1995), EERI Spectra (EERI, 1990), Skinner, et al. (1993), U.S. Conference on Earthquake Engineering (1990 and 1994), and World Conference on Earthquake Engineering (1988, 1992, 1996, and 2000).

In the mid-1980s, the initial applications identified a need to supplement existing codes with design requirements developed specifically for seismically isolated buildings. Code development work occurred throughout the late 1980s. The status of U.S. seismic isolation design requirements as of May 2003 is as follows:

1. In late 1989, the Structural Engineers Association of California (SEAOC) State Seismology Committee adopted an “Appendix to Chapter 2” of the SEAOC Blue Book entitled, “General Requirements for the Design and Construction of Seismic-Isolated Structures.” These requirements were submitted to the International Conference of Building Officials (ICBO) and were adopted by ICBO as an appendix of the 1991 *Uniform Building Code (UBC)*. The most current version of these regulations may be found in the ASCE-7-02 (ASCE, 2003) and the 2003 International Building Code (ICC, 2003)..
2. In 1991 the Federal Emergency Management Agency (FEMA) initiated a 6-year program to develop a set of nationally applicable guidelines for seismic rehabilitation of existing buildings. These guidelines (known as the *NEHRP Guidelines for the Seismic Rehabilitation of Buildings*) were published as FEMA 273. In 2000, FEMA 273 was republished, with minor amendments, as FEMA 356, *Prestandard and Commentary for the Seismic Rehabilitation of Buildings*. The design and analysis methods of the *NEHRP Guidelines* and the FEMA *Prestandard* parallel closely methods required by the *NEHRP Recommended Provisions* for new buildings, except that more liberal design is permitted for the superstructure of a rehabilitated building.

A general concern has long existed regarding the applicability of different types of isolation systems. Rather than addressing a specific method of base isolation, the *Provisions* provides general design requirements applicable to a wide range of possible seismic isolation systems.

Although remaining general, the design requirements rely on mandatory testing of isolation-system hardware to confirm the engineering parameters used in the design and to verify the overall adequacy of the isolation system. Some systems may not be capable of demonstrating acceptability by test and, consequently, would not be permitted. In general, acceptable systems will: (1) remain stable for

required design displacements, (2) provide increasing resistance with increasing displacement, (3) not degrade under repeated cyclic load, and (4) have quantifiable engineering parameters (such as force-deflection characteristics and damping).

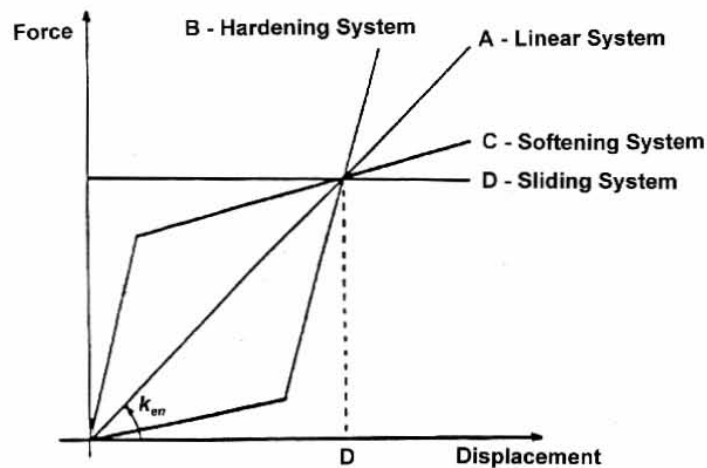

Figure C13.1-1 Idealized force-deflection relationships for isolation systems (stiffness effects of sacrificial wind-restraint systems not shown for clarity).

Conceptually, there are four basic types of isolation system force-deflection relationships. These idealized relationships are shown in Figure C13.1-1 with each idealized curve having the same design displacement, D_D , for the design earthquake. A linear isolation system is represented by Curve A and has the same isolated period for all earthquake load levels. In addition, the force generated in the superstructure is directly proportional to the displacement across the isolation system.

A hardening isolation system is represented by Curve B. This system is soft initially (long effective period) and then stiffens (effective period shortens) as the earthquake load level increases. When the earthquake load level induces displacements in excess of the design displacement in a hardening system, the superstructure is subjected to higher forces and the isolation system to lower displacements than a comparable linear system.

A softening isolation system is represented by Curve C. This system is stiff initially (short effective period) and softens (effective period lengthens) as the earthquake load level increases. When the earthquake load level induces displacements in excess of the design displacement in a softening system, the superstructure is subjected to lower forces and the isolation system to higher displacements than a comparable linear system.

A sliding isolation system is represented by Curve D. This system is governed by the friction force of the isolation system. Like the softening system, the effective period lengthens as the earthquake load level increases and loads on the superstructure remain constant.

The total system displacement for extreme displacement of the sliding isolation system, after repeated earthquake cycles, is highly dependent on the vibratory characteristics of the ground motion and may exceed the design displacement, D_D . Consequently, minimum design requirements do not adequately define peak seismic displacement for seismic isolation systems governed solely by friction forces.

13.1.1 Scope. The requirements of Chapter 13 provide isolator design displacements, shear forces for structural design, and other specific requirements for seismically isolated structures. All other design requirements including loads (other than seismic), load combinations, allowable forces and stresses, and horizontal shear distribution are covered by the applicable sections of the *Provisions* for conventional, fixed-base structures.

13.2 GENERAL DESIGN REQUIREMENTS

13.2.1 Occupancy importance factor. Ideally, most of the lateral displacement of an isolated structure will be accommodated by deformation of the isolation system rather than distortion of the structure above. Accordingly, the lateral-load-resisting system of the structure above the isolation system should be designed to have sufficient stiffness and strength to avoid large, inelastic displacements. For this reason, the *Provisions* contains criteria that limit the inelastic response of the structure above the isolation system. Although damage control for the design-level earthquake is not an explicit objective of the *Provisions*, an isolated structure designed to limit inelastic response of the structural system also will reduce the level of damage that would otherwise occur during an earthquake. In general, isolated structures designed in conformance with the *Provisions* should be able:

1. To resist minor and moderate levels of earthquake ground motion without damage to structural elements, nonstructural components, or building contents; and
2. To resist major levels of earthquake ground motion without failure of the isolation system, without significant damage to structural elements, without extensive damage to nonstructural components, and without major disruption to facility function.

The above performance objectives for isolated structures considerably exceed the performance anticipated for fixed-base structures during moderate and major earthquakes. Table C13.2-1 provides a tabular comparison of the performance expected for isolated and fixed-base structures designed in accordance with the *Provisions*. Loss of function is not included in Table C13.2-1. For certain (fixed-base) facilities, loss of function would not be expected to occur until there is significant structural damage causing closure or restricted access to the building. In other cases, the facility could have only limited or no structural damage but would not be functional as a result of damage to vital nonstructural components and contents. Isolation would be expected to mitigate structural and nonstructural damage and to protect the facility against loss of function.

Table C13.2-1 Protection Provided by NEHRP Recommended *Provisions* for Minor, Moderate, and Major Levels of Earthquake Ground Motion

Risk Category	Earthquake Ground Motion Level		
	Minor	Moderate	Major
Life safety ^a	F, I	F, I	F, I
Structural damage ^b	F, I	F, I	I
Nonstructural damage ^c (contents damage)	F, I	I	I
^a Loss of life or serious injury is not expected. ^b Significant structural damage is not expected. ^c Significant nonstructural (contents) damage is not expected. F indicates fixed base; I indicates isolated.			

13.2.3.1 Design spectra. Site-specific design spectra must be developed for both the design earthquake and the maximum considered earthquake if the structure is located at a site with S_I greater than 0.60 or on a Class F site. All requirements for spectra are in Sec. 3.3 and 3.4.

13.2.4 Procedure selection. The design requirements permit the use of one of three different analysis procedures for determining the design-level seismic loads. The first procedure uses a simple, lateral-force formula (similar to the lateral-force coefficient now used in conventional building design) to prescribe peak lateral displacement and design force as a function of spectral acceleration and isolated-building period and damping. The second and third methods, which are required for geometrically complex or especially flexible buildings, rely on dynamic analysis procedures (either response spectrum or time history) to determine peak response of the isolated building.

The three procedures are based on the same level of seismic input and require a similar level of performance from the building. There are benefits in performing a more complex analysis in that slightly lower design forces and displacements are permitted as the level of analysis becomes more sophisticated. The design requirements for the structural system are based on the design earthquake, a severe level of earthquake ground motion defined as two-thirds of the maximum considered earthquake. The isolation system—including all connections, supporting structural elements, and the “gap”—is required to be designed (and tested) for 100 percent of maximum considered earthquake demand. Structural elements above the isolation system are not required to be designed for the full effects of the design earthquake, but may be designed for slightly reduced loads (that is, loads reduced by a factor of up to 2.0) if the structural system has sufficient ductility, etc., to respond inelastically without sustaining significant damage. A similar fixed-base structure would be designed for loads reduced by a factor of 8 rather than 2.

This section delineates the requirements for the use of the equivalent lateral force procedure and dynamic methods of analysis. The limitations on the simplified lateral-force design procedure are quite severe at this time. Limitations cover the site location with respect to active faults; soil conditions of the site, the height, regularity and stiffness characteristics of the building; and selected characteristics of the isolation system. Response-history analysis is required to determine the design displacement of the isolation system (and the structure above) for the following isolated structures:

1. Isolated structures with a “nonlinear” isolation system including, but not limited to, isolation systems utilizing friction or sliding surfaces, isolation systems with effective damping values greater than about 30 percent of critical, isolation systems not capable of producing a significant restoring force, and isolation systems that restrain or limit extreme earthquake displacement;
2. Isolated structures with a “nonlinear” structure (above the isolation system) including, but not limited to, structures designed for forces that are less than those specified by the *Provisions* for “essentially-elastic” design; and
3. Isolated structures located on Class F site (that is, very soft soil).

Lower-bound limits on isolation system design displacements and structural-design forces are specified by the *Provisions* in Sec. 13.4 as a percentage of the values prescribed by the equivalent-lateral-force design formulas, even when dynamic analysis is used as the basis for design. These lower-bound limits on key design parameters ensure consistency in the design of isolated structures and serve as a “safety net” against gross under-design. Table C13.2-2 provides a summary of the lower-bound limits on dynamic analysis specified by the *Provisions*.

13.2.4.3 Variations in material properties: For analysis, the mechanical properties of seismic isolators are generally based on values provided by isolator manufacturers. The properties are evaluated by prototype testing, which often occurs shortly after the isolators have been manufactured, and checked with respect to the values assumed for design. Unlike conventional materials whose properties do not vary substantially with time, seismic isolators are composed of materials whose properties will generally vary with time. Because (a) mechanical properties can vary over the life span of a building, and (b) the testing protocol of Section 13.6 cannot account for the effects of aging, contamination, scragging (temporary degradation of mechanical properties with repeated cycling), temperature, velocity effects, and wear, the engineer-of-record must account for these effects by explicit analysis. One strategy for accommodating these effects makes use of property modification factors, which was introduced by Constantinou et al. (1999) in the AASHTO Guide Specification for Seismic Isolation Design (AASHTO, 1999). Constantinou et al. (1999) also provides information on variations in material properties for sliding isolation systems. Thompson et al. (2000) and Morgan et al. (2001) provide information on variations in material properties for elastomeric bearings.

Table C13.2-2 Lower-Bound Limits on Dynamic Procedures Specified in Relation to ELF Procedure Requirements

Design Parameter	ELF Procedure	Dynamic Procedure	
		Response Spectrum	Response History
Design displacement – D_D	$D_D = (g/4\pi^2)(S_{DI}T_D/B_D)$	–	–
Total design displacement - D_T	$D_T \geq 1.1D$	$\geq 0.9D_T$	$\geq 0.9D_T$
Maximum displacement – D_M	$D_M = (g/4\pi^2)(S_{MI}T_M/B_M)$	–	–
Total maximum displacement - D_{TM}	$D_{TM} \geq 1.1D_M$	$\geq 0.8D_{TM}$	$\geq 0.8D_{TM}$
Design shear – V_b (at or below the isolation system)	$V_b = k_{Dmax}D_D$	$\geq 0.9V_b$	$\geq 0.9V_b$
Design shear – V_s (“regular” superstructure)	$V_s = k_{Dmax}D_D/R_I$	$\geq 0.8V_s$	$\geq 0.6V_s$
Design shear – V_s (“irregular” superstructure)	$V_s = k_{Dmax}D_D R_I$	$\geq 1.0V_s$	$\geq 0.8V_s$
Drift (calculated using R_I for C_d)	$0.015h_{sx}$	$0.015h_{sx}$	$0.020h_{sx}$

13.2.5 Isolation system

13.2.5.1 Environmental conditions. Environmental conditions that may adversely affect isolation system performance should be thoroughly investigated. Significant research has been conducted on the effects of temperature, aging, etc., on isolation systems since the 1970s in Europe, New Zealand, and the United States.

13.2.5.2 Wind forces. Lateral displacement over the depth of the isolator zone resulting from wind loads should be limited to a value similar to that required for other story heights.

13.2.5.3 Fire resistance. In the event of a fire, the isolation system should be capable of supporting the weight of the building, as required for other vertical-load-supporting elements of the structure, but may have diminished functionality for lateral (earthquake) load.

13.2.5.4 Lateral-restoring force. The isolation system should be configured with a lateral-restoring force sufficient to avoid significant residual displacement as a result of an earthquake, such that the isolated structure will not have a stability problem so as to be in a condition to survive aftershocks and future earthquakes.

13.2.5.5 Displacement restraint. The use of a displacement restraint is not encouraged by the *Provisions*. Should a displacement restraint system be implemented, explicit analysis of the isolated structure for maximum considered earthquake is required to account for the effects of engaging the displacement restraint.

13.2.5.6 Vertical-load stability. The vertical loads to be used in checking the stability of any given isolator should be calculated using bounding values of dead load and live load and the peak earthquake demand of the maximum considered earthquake. Since earthquake loads are reversible in nature, peak earthquake load should be combined with bounding values of dead and live load in a manner which produces both the maximum downward force and the maximum upward force on any isolator. Stability of each isolator should be verified for these two extreme values of vertical load at peak maximum considered earthquake displacement of the isolation system.

13.2.5.7 Overturning. The intent of this requirement is to prevent both global structural overturning and overstress of elements due to local uplift. Uplift in a braced frame or shear wall is acceptable so long as the isolation system does not disengage from its horizontal-resisting connection detail. The connection details used in some isolation systems are such that tension is not permitted on the system. If the tension capacity of an isolation system is to be utilized to resist uplift forces, then component tests should be performed to demonstrate the adequacy of the system to resist tension forces at the design displacement.

13.2.5.8 Inspection and replacement. Although most isolation systems will not need to be replaced after an earthquake, it is good practice to provide for inspection and replacement. After an earthquake, the building should be inspected and any damaged elements should be replaced or repaired. It is advised that periodic inspections be made of the isolation system.

13.2.5.9 Quality control. A test and inspection program is necessary for both fabrication and installation of the isolation system. Because base isolation is a developing technology, it may be difficult to reference standards for testing and inspection. Reference can be made to standards for some materials such as elastomeric bearings (ASTM D 4014). Similar standards are required for other isolation systems. Special inspection procedures and load testing to verify manufacturing quality should be developed for each project. The requirements will vary with the type of isolation system used.

13.2.6 Structural system

13.2.6.1 Horizontal distribution of force

13.2.6.2 Building separations. A minimum separation between the isolated structure and a rigid obstruction is required to allow free movement of the superstructure in all lateral directions during an earthquake. Provision should be made for lateral motion greater than the design displacement, since the exact upper limit of displacement cannot be precisely determined.

13.2.7 Elements of structures and nonstructural components. To accommodate the differential movement between the isolated building and the ground, provision for flexible utility connections should be made. In addition, rigid structures crossing the interface (such as stairs, elevator shafts and walls) should have details to accommodate differential motion at the isolator level without sustaining damage sufficient to threaten life safety.

13.3 EQUIVALENT LATERAL FORCE PROCEDURE

13.3.2 Minimum lateral displacements. The lateral displacement given by Eq. 13.3-1 approximates peak design earthquake displacement of a single-degree-of-freedom, linear-elastic system of period, T_D , and equivalent viscous damping, β_D , and the lateral displacement given by Eq. 13.3-3 approximates peak maximum considered earthquake displacement of a single-degree-of-freedom, linear-elastic system of period, T_M , and equivalent viscous damping, β_{DM} .

Equation 13.3-1 is an estimate of peak displacement in the isolation system for the design earthquake. In this equation, the spectral acceleration term, S_{DI} , is the same as that required for design of a conventional fixed-base structure of period, T_D . A damping term, B_D , is used to decrease (or increase) the computed displacement when the equivalent damping coefficient of the isolation system is greater (or smaller) than 5 percent of critical damping. Values of coefficient B_D (or B_M for the maximum considered earthquake) are given in Table 13.3-1 for different values of isolation system damping, β_D (or β_M).

A comparison of values obtained from Eq. 13.3-1 and those obtained from nonlinear time-history analyses are given in Kircher et al. (1988) and Constantinou et al. (1993).

Consideration should be given to possible differences in the properties of the isolation system used for design and the properties of isolation system actually installed in the building. Similarly, consideration should be given to possible changes in isolation system properties due to different design conditions or load combinations. If the true deformational characteristics of the isolation system are not stable or vary

with the nature of the load (being rate-, amplitude-, or time-dependent), the design displacements should be based on deformational characteristics of the isolation system that give the largest possible deflection (k_{Dmin}), the design forces should be based on deformational characteristics of the isolation system that give the largest possible force (k_{Dmax}), and the damping level used to determine design displacements and forces should be based on deformational characteristics of the isolation system that represent the minimum amount of energy dissipated during cyclic response at the design level.

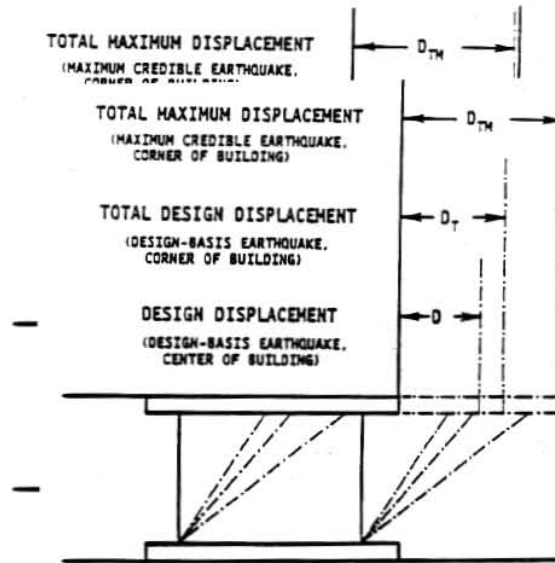

Figure C13.3-1 Displacement terminology.

The configuration of the isolation system for a seismically isolated building or structure should be selected in such a way as to minimize any eccentricity between the center of mass of the superstructure and the center of rigidity of the isolation system. In this way, the effect of torsion on the displacement of isolation elements will be reduced. As for conventional structures, allowance for accidental eccentricity in both horizontal directions must be considered. Figure C13.3-1 defines the terminology used in the *Provisions*. Equation 13.3-5 (or Eq. 13.3-6 for the maximum considered earthquake) provides a simplified formulae for estimating the response due to torsion in lieu of a more refined analysis. The additional component of displacement due to torsion increases the design displacement at the corner of the structure by about 15 percent (for a perfectly square building in plan) to about 30 percent (for a very long, rectangular building) if the eccentricity is 5 percent of the maximum plan dimension. Such additional displacement, due to torsion, is appropriate for buildings with an isolation system whose stiffness is uniformly distributed in plan. Isolation systems that have stiffness concentrated toward the perimeter of the building or certain sliding systems that minimize the effects of mass eccentricity will have reduced displacements due to torsion. The *Provisions* permits values of D_T as small as $1.1D_D$, with proper justification.

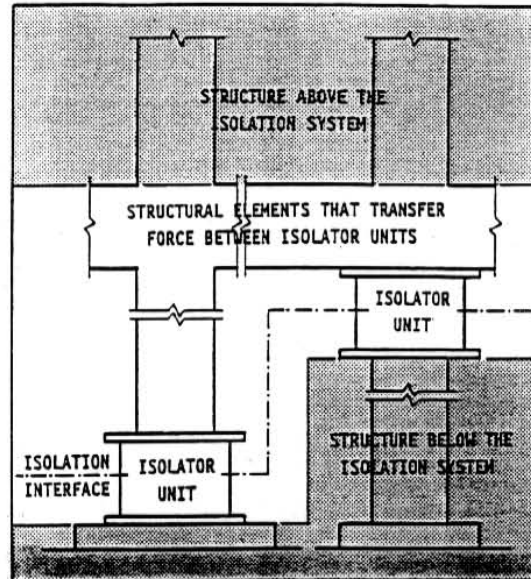

Figure C13.3-2 Isolation system terminology

13.3.3 Minimum lateral forces. Figure C13.3-2 defines the terminology below and above the isolation system. Equation 13.3-7 gives peak seismic shear on all structural components at or below the seismic interface without reduction for ductile response. Equation 13.3-8 specifies the peak seismic shear for design of structural systems above the seismic interface. For structures that have appreciable inelastic-deformation capability, this equation includes an effective reduction factor of up to 2 for response beyond the strength-design level.

The basis for the reduction factor is that the design of the structural system is based on strength-design procedures. A factor of at least 2 is assumed to exist between the design-force level and the true-yield level of the structural system. An investigation of 10 specific buildings indicated that this factor varied between 2 and 5 (ATC, 1982). Thus, a reduction factor of 2 is appropriate to ensure that the structural system remains essentially elastic for the design earthquake.

In Sec. 13.3.3.2, the limitations given on V_S ensure that there is at least a factor of 1.5 between the nominal yield level of the superstructure and (1) the yield level of the isolation system, (2) the ultimate capacity of a sacrificial wind-restraint system which is intended to fail and release the superstructure during significant lateral load, or (3) the break-away friction level of a sliding system.

These limitations are essential to ensure that the superstructure will not yield prematurely before the isolation system has been activated and significantly displaced.

The design shear force, V_S , specified by the requirements of this section ensures that the structural system of an isolated building will be subjected to significantly lower inelastic demands than a conventionally designed structure. Further reduction in V_S , such that the inelastic demand on a seismically isolated structure would be the same as the inelastic demand on a conventionally designed structure, was not considered during development of these requirements but may be considered in the future.

If the level of performance of the isolated structure is desired to be greater than that implicit in these requirements, then the denominator of Eq. 13.3-8 may be reduced. Decreasing the denominator of Eq. 13.3-8 will lessen or eliminate inelastic response of the superstructure for the design-basis event.

13.3.4 Vertical distribution of forces. Equation 13.3-9 describes the vertical distribution of lateral force based on an assumed triangular distribution of seismic acceleration over the height of the structure

above the isolation interface. Constantinou et al. (1993) provides a good summary of recent work which demonstrates that this vertical distribution of force will always provide a conservative estimate of the distributions obtained from more detailed, nonlinear analysis studies.

13.3.5 Drift limits. The maximum story drift permitted for design of isolated structures varies depending on the method of analysis used, as summarized in Table C13.3-1. For comparison, the drift limits prescribed by the *Provisions* for fixed-base structures also are summarized in Table C13.3-1.

Table C13.3-1 Comparison of Drift Limits for Fixed-Base and Isolated Structures

Structure	Seismic Use Group	Fixed-Base	Isolated
Buildings (other than masonry) four stories or less in height with component drift design	I	$0.025h_{sx}/(C_d/R)$	$0.015h_{sx}$
	II	$0.020h_{sx}/(C_d/R)$	$0.015h_{sx}$
	III	$0.015h_{sx}/(C_d/R)$	$0.015h_{sx}$
Other (non-masonry) buildings	I	$0.020h_{sx}/(C_d/R)$	$0.015h_{sx}$
	II	$0.015h_{sx}/(C_d/R)$	$0.015h_{sx}$
	III	$0.010h_{sx}/(C_d/R)$	$0.015h_{sx}$

Drift limits in Table C13.3-1 are divided by C_d/R for fixed-base structures since displacements calculated for lateral loads reduced by R are factored by C_d before checking drift. The C_d term is used throughout the *Provisions* for fixed-base structures to approximate the ratio of actual earthquake response to response calculated for “reduced” forces. Generally, C_d is 1/2 to 4/5 the value of R . For isolated structures, the R_I factor is used both to reduce lateral loads and to increase displacements (calculated for reduced lateral loads) before checking drift. Equivalency would be obtained if the drift limits for both fixed-base and isolated structures were based on their respective R factors. It may be noted that the drift limits for isolated structures are generally more conservative than those for conventional, fixed-base structures, even when fixed-base structures are designed as Seismic Use Group III buildings.

13.4 DYNAMIC PROCEDURES

This section specifies the requirements and limits for dynamic procedures. The design displacement and force limits on response spectrum and response history procedures are given in Table C13.2-1.

A more-detailed or refined study can be performed in accordance with the analysis procedures described in this section. The intent of this section is to provide procedures which are compatible with the minimum requirements of Sec. 13.3. Reasons for performing a more refined study include:

1. The importance of the building.
2. The need to analyze possible structure/isolation-system interaction when the fixed-base period of the building is greater than one third of the isolated period.
3. The need to explicitly model the deformational characteristics of the lateral-force-resisting system when the structure above the isolation system is irregular.
4. The desirability of using site-specific ground-motion data, especially for soft soil types (Site Class F) or for structures located where S_I is greater than 0.60.
5. The desirability of explicitly modeling the deformational characteristics of the base-isolation system. This is especially important for systems that have damping characteristics that are amplitude-dependent, rather than velocity-dependent, since it is difficult to determine an appropriate value of equivalent viscous damping for these systems.

Sec. 13.2.4 of this commentary discusses other conditions which require use of the response history procedure.

When response history analysis is used as the basis for design, the design displacement of the isolation system and design forces in elements of the structure above are to be based on the maximum of the results of not less than three separate analyses, each using a different pair of horizontal time histories. Each pair of horizontal time histories should:

1. Be of a duration consistent with the design earthquake or the maximum considered earthquake,
2. Incorporate near-field phenomena, as appropriate, and
3. Have response spectra for which the square-root-of-the-sum-of-the-squares combination of the two horizontal components equals or exceeds 1.3 times the “target” spectrum at each spectral ordinate.

The average value of seven time histories is a standard required by the nuclear industry and is considered appropriate for nonlinear response history analysis of seismically isolated structures.

13.5 DESIGN REVIEW

Review of the design and analysis of the isolation system and design review of the isolator testing program is mandated by the *Provisions* for two key reasons:

1. The consequences of isolator failure could be catastrophic.
2. Isolator design and fabrication technology is evolving rapidly and may be based on technologies unfamiliar to many design professionals.

The *Provisions* requires review to be performed by a team of registered design professionals that are independent of the design team and other project contractors. The review team should include individuals with special expertise in one or more aspects of the design, analysis, and implementation of seismic isolation systems.

The review team should be formed prior to the development of design criteria (including site-specific ground shaking criteria) and isolation system design options. Further, the review team should have full access to all pertinent information and the cooperation of the design team and regulatory agencies involved with the project.

13.6 TESTING

The design displacements and forces developed from the *Provisions* are predicated on the basis that the deformational characteristics of the base isolation system have been previously defined by a comprehensive set of tests. If a comprehensive amount of test data are not available on a system, major design alterations in the building may be necessary after the tests are complete. This would result from variations in the isolation-system properties assumed for design and those obtained by test. Therefore, it is advisable that prototype systems be tested during the early phases of design, if sufficient test data is not available on an isolation system.

Typical force-deflection (or hysteresis) loops are shown in Figure C13.6-1; also included are the definitions of values used in Sec. 13.6.2.

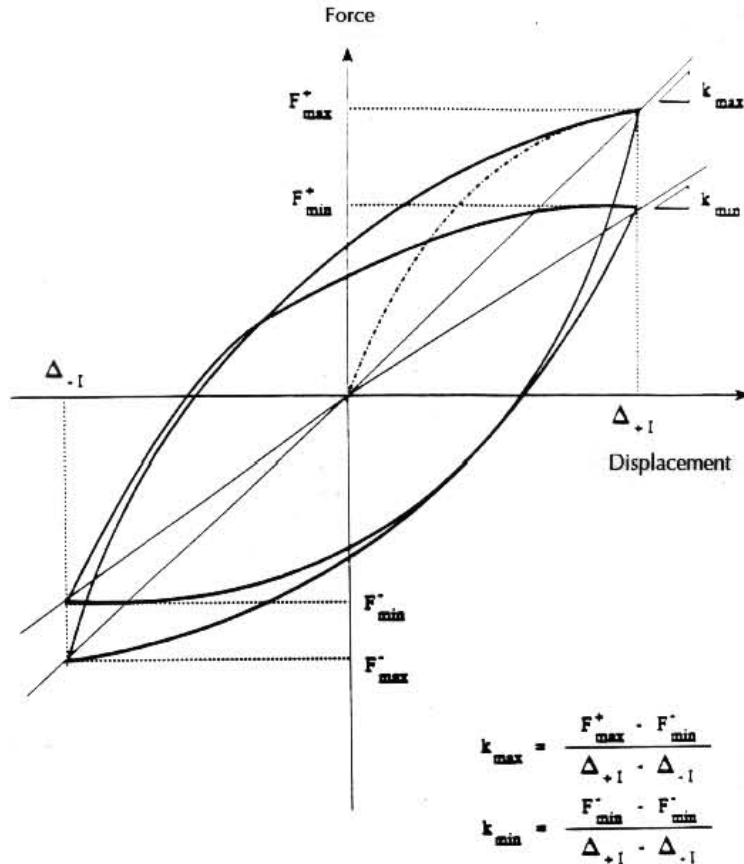

Figure C13.6-1 The effect of stiffness on an isolation bearing.

The required sequence of tests will verify experimentally:

1. The assumed stiffness and capacity of the wind-restraining mechanism;
2. The variation in the isolator's deformational characteristics with amplitude (and with vertical load, if it is a vertical load-carrying member);
3. The variation in the isolator's deformational characteristics for a realistic number of cycles of loading at the design displacement; and
4. The ability of the system to carry its maximum and minimum vertical loads at the maximum displacement.

Force-deflection tests are not required if similarly sized components have been tested previously using the specified sequence of tests.

Variations in effective stiffness greater than 15 percent over 3 cycles of loading at a given amplitude, or greater than 20 percent over the larger number of cycles at the design displacement, would be cause for rejection. The variations in the vertical loads required for tests of isolators which carry vertical, as well as lateral, load are necessary to determine possible variations in the system properties with variations in overturning force. The appropriate dead loads and overturning forces for the tests are defined as the average loads on a given type and size of isolator for determining design properties and are the absolute maximum and minimum loads for the stability tests.

13.6.4 Design properties of the isolation system

13.6.4.1 Maximum and minimum effective stiffness. The effective stiffness is determined from the hysteresis loops shown in Figure C13.6-1). Stiffness may vary considerably as the test amplitude

increases but should be reasonably stable (within 15 percent) for more than 3 cycles at a given amplitude.

The intent of these requirements is to ensure that the deformational properties used in design result in the maximum design forces and displacements. For determining design displacement, this means using the lowest damping and effective-stiffness values. For determining design forces, this means using the lowest damping value and the greatest stiffness value.

13.6.4.2 Effective damping. The determination of equivalent viscous damping is reasonably reliable for systems whose damping characteristics are velocity dependent. For systems that have amplitude-dependent, energy-dissipating mechanisms, significant problems arise in determining an equivalent viscous-damping value. Since it is difficult to relate velocity and amplitude-dependent phenomena, it is recommended that when the equivalent-viscous damping assumed for the design of amplitude-dependent, energy-dissipating mechanisms (such as pure-sliding systems) is greater than 30 percent, then the design-basis force and displacement should be determined using the response history procedure, as discussed in *Commentary* Sec. 13.2.4.

REFERENCES

- ATC. 1982. *An Investigation of the Correlation Between Earthquake Ground Motion and Building Performance*, ATC Report 10. Redwood City, California: Applied Technology Council.
- ATC. 1986. *Proceedings of a Seminar and Workshop on Base Isolation and Passive Energy Dissipation*, ATC Report 17. Redwood City, California: Applied Technology Council.
- ATC. 1993. *Proceedings of Seminar on Seismic Isolation, Passive Energy Dissipation, and Active Control*, ATC 17-1., Redwood City, California: Applied Technology Council.
- ATC. 2002. *Seminar on Response Modification Technologies for Performance-Based Seismic Design*, ATC 17-2. Redwood City, California: Applied Technology Council.
- AASHTO. 1999. *Guide Specification for Seismic Isolation Design*, Washington, D.C: American Association of State Highway and Transportation Officials.
- ASCE. 2003. *Minimum Design Loads for Buildings and Other Structures*, ASCE-7-02, Reston, VA: American Society of Civil Engineers.
- ASCE. 1989, 1991, 1993, and 1995. *Seismic Engineering: Research and Practice*. New York City: American Society of Civil Engineers.
- Constantinou, M. C., C. W. Winters, and D. Theodossiou. 1993. "Evaluation of SEAOC and UBC analysis procedures, Part 2: Flexible superstructure," in *Proceedings of a Seminar on Seismic Isolation, Passive Energy Dissipation and Active Control*, ATC Report 17-1. Redwood City, California: ATC.
- Constantinou, M.C., P. Tsopelas, A. Kasalanati, and E. D. Wolff. 1999. "Property modification factors for seismic isolation bearings", Report No. MCEER-99-0012, Multidisciplinary Center for Earthquake Engineering Research, Buffalo, NY.
- Earthquake Engineering Research Institute. 1990. "Seismic isolation: from idea to reality," *Earthquake Spectra Journal* 6:2.
- Hussain, S.M.. 1998. "Testing and quality control issues for seismic isolation systems-an overview", in *Proceedings of of the Structural Engineers World Congress*, Paper T163-4, San Francisco, CA.
- International Code Council, 2003. *International Building Code*, Falls Creek, VA
- Kircher, C. A., B. Lashkari, R. L. Mayes, and T. E. Kelly. 1988. "Evaluation of nonlinear response in seismically isolated buildings," in *Proceedings of a Symposium on Seismic, Shock and Vibration Isolation*, ASTHMA PVP Conference.

Lashkari, B., and C. A. Kircher. 1993. "Evaluation of SEAOC & UBC analysis procedures, part 1: stiff superstructure," in *Proceedings of a Seminar on Seismic Isolation, Passive Energy Dissipation and Active Control*, ATC Report 17-1. Redwood City, California: ATC.

Morgan, T., A. S. Whittaker, and A. C. Thompson. 2001. "Cyclic behavior of high-damping rubber bearings," *Proceedings*, Fifth World Congress on Joints, Bearings and Seismic Systems for Concrete Structures, American Concrete Institute, Rome, Italy.

Skinner, R. I., W. H. Robinson, and G. H. McVerry. 1993. *An Introduction to Seismic Isolation*. Sussex, England: Wiley and Sons.

Thompson, A., A. S. Whittaker, G. L. Fenves, and S. A. Mahin. 2000. "Property modification factors for elastomeric bearings," *Proceedings*, Twelfth World Conference on Earthquake Engineering, Auckland, New Zealand.

This page is intentionally left blank.

Chapter 14 Commentary

NONBUILDING STRUCTURE DESIGN REQUIREMENTS

14.1 GENERAL

14.1.1 Scope. Requirements concerning nonbuilding structures were originally added to the 1994 *Provisions* by the 1991-94 *Provisions* Update Committee (PUC) at the request of the BSSC Board of Direction to provide building officials with needed guidance. In recognition of the complexity, nuances, and importance of nonbuilding structures, the BSSC Board established 1994-97 PUC Technical Subcommittee 13 (TS13), Nonbuilding Structures, in 1995. The duties of TS13 were to review the 1994 *Provisions* and *Commentary* and recommend changes for the 1997 Edition. The subcommittee comprised individuals possessing considerable expertise concerning various specialized nonbuilding structures and representing a wide variety of industries concerned with nonbuilding structures.

Building codes traditionally have been perceived as minimum standards of care for the design of nonbuilding structures and building code compliance of these structures is required by building officials in many jurisdictions. However, requirements in the industry standards are often at odds with building code requirements. In some cases, the industry standards need to be altered while in other cases the building codes need to be modified. Registered design professionals are not always aware of the numerous accepted standards within an industry and may not know whether the accepted standards are adequate. It is hoped that Chapter 14 of the *Provisions* appropriately bridges the gap between building codes and existing industry standards.

One of the goals of TS13 was to review and list appropriate industry standards to serve as a resource. These standards had to be included in the appendix. The subcommittee also has attempted to provide an appropriate link so that the accepted industry standards can be used with the seismic ground motions established in the *Provisions*. It should be noted that some nonbuilding structures are very similar to a building and can be designed employing sections of the *Provisions* directly whereas other nonbuilding structures require special analysis unique to the particular type of nonbuilding structure.

The ultimate goal of TS13 was to provide guidance to develop requirements consistent with the intent of the *Provisions* while allowing the use of accepted industry standards. Some of the referenced standards are consensus documents while others are not.

One good example of the dilemma posed by the conflicts between the *Provisions* and accepted design practice for nonbuilding structures involves steel multilegged water towers. Historically, such towers have performed well when properly designed in accordance with American Water Works Association (AWWA) standards, but these standards differ from the *Provisions* that tension-only rods are required and the connection forces are not amplified. However, industry practice requires upset rods that are preloaded at the time of installation, and the towers tend to perform well in earthquake areas.

In an effort to provide the appropriate interface between the *Provisions* requirements for building structures, nonstructural components, and nonbuilding structures; TS13 recommended that nonbuilding structure requirements be placed in a separate chapter. The PUC agreed with this change. The 1997 *Provisions* Chapter 14 now provides registered design professionals responsible for designing nonbuilding structures with a single point of reference.

Note that building structures, vehicular and railroad bridges, electric power substation equipment, overhead power line support structures, buried pipelines and conduits, tunnels, lifeline systems, nuclear power plants, and dams are excluded from the scope of the nonbuilding structure requirements. The excluded structures are covered by other well established design criteria (e.g., electric power substation equipment, power line support structures, vehicular and railroad bridges), are not under the jurisdiction of

local building officials (e.g., nuclear power plants, and dams), or require technical considerations beyond the scope of the *Provisions* (e.g., piers and wharves, buried pipelines and conduits, tunnels, and lifeline systems). Since many components of lifeline systems can be designed in accordance with the *Provisions*, the following information is provided to clarify why lifeline systems are excluded from the scope of the *Provisions*.

Seismic design for a lifeline system will typically require consideration of factors that are unique to or particularly important to that specific system. Seismic design requirements for lifeline systems will typically differ from those for buildings individual structural components for the following reasons:

1. **Physical characteristics.** A building consists of structural and non-structural components within a single site, whereas lifeline systems consist of networks of multiple and spatially distributed linked components (primarily non-building structures and equipment, and possibly some buildings as well.)
2. **Stakeholders.** The stakeholders in the continued operation of a building after an earthquake are a relatively small group of building owners, tenants, and insurers. Lifeline systems provide essential services to a community (e.g., electric power, communications, transportation, natural gas, water, wastewater, and liquid fuel). Therefore, stakeholders in the seismic performance of such systems are the businesses and residents of the region served by the system, business clients/vendors outside of the region whose continued operation will be impacted by the conditions of the businesses/residents within the region, and the lifeline system's owners and insurers.
3. **Performance.** Acceptable seismic performance of a building is typically measured by whether life safety of building occupants has been adequately protected (in accordance with minimum building code design provisions.) In addition, for those relatively few buildings for which performance based design has been considered, acceptable seismic performance will also be measured by how well post-earthquake functionality and return-to-service requirements of the building tenants have been met.

The ability of a lifeline system to maintain an acceptable level of service after an earthquake will depend, not only on the seismic performance of its various spatially dispersed components, but also on the redundancy and service capacity of these components (e.g., number of lanes within roadway elements). To the extent that a lifeline system is comprised of redundant components of sufficient service capacity, it can maintain an acceptable level of service to a community even if some of the redundant components are damaged during the earthquake. In addition, except for certain transportation structures (e.g., bridges and tunnels), earthquake damage to the lifeline system components generally do not result in direct life-safety consequences. Therefore, acceptable seismic performance for a lifeline system is typically based on: (a) whether the system provides an adequate level of service to its users after an earthquake; (b) whether economic losses related to direct damage, lost revenue from an inoperable system, and liability exposure are within tolerable limits; and (c) whether any adverse political, legal, social, administrative, or environmental consequences are experienced. For these reasons, acceptable seismic performance requirements for lifeline systems are best established through interaction with the appropriate stakeholders, including the lifeline agency, its customers or users, and appropriate regulatory interests.

The definition of what constitutes a component of a lifeline system is often complicated. Components of utility lifeline systems are typically identical to components that might be found in industrial or commercial applications. A good example of this overlap are aboveground storage tanks that are common in large industrial or manufacturing facilities as well as water and liquid hydrocarbon transportation systems. Because of this similarity, a clear definition is needed to determine when design in accordance with the recommended approach for lifeline systems should be given preference over requirements in the *Provisions*. Three criteria are considered for determining whether the design of a particular nonbuilding structure can be treated as a component of a lifeline system.

1. **Spatial distribution.** As noted above, lifeline systems are typically spatially-distributed systems that provide services considered essential to community activities and include electric power, communications, water, waste-water, natural gas, liquid fuel, and transportation systems. Fixed facilities, such as power plants, compressor stations, metering stations, are typically treated as nodes

of a lifeline system and are designed in accordance with these Provisions.

2. **Definition by legal boundary.** Portions of utility lifeline systems upstream of the point defining the legal boundary for ownership and responsibility for maintenance and repair shall be considered as part of a lifeline system. The physical elements of transportation lifeline systems not excluded in the *Provisions* and owned and maintained by a transportation agency are also considered part of a lifeline system.

Defining lifeline system components by a legal boundary is most appropriate for utility systems that deliver electric power, natural gas, electric power, wastewater and some telecommunication services. Existing regulatory provisions commonly specify a specific interface between the portions of these systems that is under the control of the service provider and the portions of the system under control of the building or facility owner. For electric power, natural gas, and water systems, this boundary is typically the customer's side of the meter. The other typical boundary is the property line. Those components under control of the service provider can be considered as part of a lifeline system.

It is common for the design and maintenance of physical elements of transportation lifeline systems to fall under the jurisdiction of a governmental or government-regulated entity. Two common examples include state highway departments and port authorities. In such cases, the definition of a lifeline system by legal boundary for these situations is defined by the jurisdiction of these agencies.

3. **Definition by expertise.** Historically, the primary audience of the *Provisions* has been the structural engineering community and building code organizations seeking to modify their seismic provisions. As a result of this focus, the *Provisions* are best suited for the seismic design and performance of individual structures. Since most new construction for lifeline systems address adding components to existing systems, rational design approaches should consider the overall system performance in design of new components and the benefits of improved seismic performance in comparison with the performance of the system for other natural and other hazards, such as man-made threats. The geographically diverse nature of lifeline systems often requires that earthquake hazards be defined by one or more scenario events instead of the probabilistic ground motion hazards defined in the *Provisions*. These additional considerations often require special expertise in addition to that of the structural engineering profession that is dominant audience for the *Provisions*.

14.1.2 References

American Concrete Institute (ACI):

ACI 350, *Environmental Engineering Concrete Structures*, 2001.

ACI 350.3 *Seismic Design of Liquid-Containing Concrete Structures*, 2001.

American Society of Civil Engineers (ASCE):

Guidelines for Seismic Evaluation and Design of Petrochemical Facilities, 1997.

Housner, G.W. *Earthquake Pressures in Fluid Containers*, California Institute of Technology, 1954.

Miller, C. D., S. W. Meier, and W. J. Czaska, *Effects of Internal Pressure on Axial Compressive Strength of Cylinders and Cones*, Structural Stability Research Council Annual Technical Meeting, June 1997.

Rack Manufacturers Institute:

Specification for the Design, Testing, and Utilization of Industrial Steel Storage Racks, 1997 (Reaffirmed 2002).

Troitsky, M.S., *Tubular Steel Structures*, 1990. (Troitsky)

Wozniak, R. S., and W. W. Mitchell, *Basis of Seismic Design Provisions for Welded Steel Oil Storage Tanks*, 1978 Proceedings—Refining Dept., Vol. 57, American Petroleum Institute, Washington, D.C., May 9, 1978. (Wozniak)

14.1.2.2 Other references

While not cited directly in the Provisions or Commentary, the user may find these other references related to nonbuilding structures helpful.

- ACI 307, *Standard Practice for the Design and Construction of Cast-In-Place Reinforced Concrete Chimneys*, 1995.
- ANSI K61.1 *Safety Requirements for the Storage and Handling of Anhydrous Ammonia*, American National Standards Institute, 1999.
- API 2510 *Design and Construction of Liquefied Petroleum Gas Installation*, American Petroleum Institute, 19952001.
- ASCE Petro *Design of Secondary Containment in Petrochemical Facilities* (Petrochemical Energy Committee Task Report), American Society of Civil Engineers, 1997.
- ASME B31.8 *Gas Transmission and Distribution Piping Systems*, American Society of Mechanical Engineers, 1995.
- ASME B96.1 *Welded Aluminum-Alloy Storage Tanks*, American Society of Mechanical Engineers, 1993.
- ASME STS-1 *Steel Stacks*, American Society of Mechanical Engineers, 2001.
- ASTM F 1159 *Standard Practice for the Design and Manufacture of Amusement Rides and Devices* (ASTM F 1159-97a), American Society for Testing and Materials, 1997.
- ASTM C 1298 *Standard Guide for Design and Construction of Brick Liners for Industrial Chimneys* (ASTM C 1298-95), American Society for Testing and Materials, 1995.
- DOT 49CFR193 *Liquefied Natural Gas Facilities: Federal Safety Standards* (Title 49CFR Part 193), U.S. Department of Transportation, 2000.
- NFPA 30 *Flammable and Combustible Liquids Code*, National Fire Protection Association, 12000.
- NFPA 58 *Storage and Handling of Liquefied Petroleum Gas*, National Fire Protection Association, 2001.
- NFPA 59 *Storage and Handling of Liquefied Petroleum Gases at Utility Gas Plants*, National Fire Protection Association, 2001.
- NFPA 59A *Production, Storage and Handling of Liquefied Natural Gas (LNG)*, National Fire Protection Association, 2001.
- NCEL R-939 Ebeling, R. M., and Morrison, E. E., *The Seismic Design of Waterfront Retaining Structures*, Naval Civil Engineering Laboratory, 1993.
- NAVFAC DM-25.1 *Piers and Wharves*, U.S. Naval Facilities Engineering Command, 1987.
- TM 5-809-10 *Seismic Design for Buildings*, U.S. Army Corps of Engineers, 1992, Chapter 13 only.

14.1.5 Nonbuilding structures supported by other structures. This section has been developed to provide an appropriate link between the requirements for nonbuilding structures and those for inclusion in the rest of the *Provisions*—especially the requirements for architectural, mechanical, and electrical components.

14.2 GENERAL DESIGN REQUIREMENTS

14.2.1 Seismic use groups and importance factors. The Importance Factors and Seismic Use Group classifications assigned to nonbuilding structures vary from those assigned to building structures.

Buildings are designed to protect occupants inside the structure whereas nonbuilding structures are not normally “occupied” in the same sense as buildings, but need to be designed in a special manner because they pose a different sort of risk in regard to public safety (that is, they may contain very hazardous compounds or be essential components in critical lifeline systems). For example, tanks and vessels may contain materials that are essential for lifeline functions following a seismic event (such as fire-fighting or potable water), potentially harmful or hazardous to the environment or general health of the public, biologically lethal or toxic, or explosive or flammable (posing a threat of consequential or secondary damage).

If not covered by the authority having jurisdiction, Table 14.2-1 may be used to select the importance factor (*I*). The value shall be determined by taking the larger of the value from the approved Standard or the value selected from Table 14.2-1. It should be noted that a single value of importance factor may not apply to an entire facility. For further details, refer to ASCE Petro. The use of a secondary containment system, when designed in accordance with an acceptable National Standard, could be considered as an effective means to contain hazardous substances and thus reduce the hazard classification.

The specific definition of material hazard and what constitutes a hazard is being developed in the *International Building Code* process. The hazards will be predicated on the quantity and type of hazardous material.

The importance factor is not intended for use in making economic evaluations regarding the level of damage, probabilities of occurrence, or cost to repair the structure. These economic decisions should be made by the owner and other interested parties (insurers, financiers, etc.). Nor it is intended for use for purposes other than that defined in this provision.

Examples are presented below demonstrate how this table may be applied.

Example 1. A water storage tank used to provide pressurized potable water for a process within a chemical plant where the tank is located away from personnel working within the facility.

Table 14.2-1 Seismic Use Groups and Importance Factors for Nonbuilding Structures

Seismic Use Group	I	II	III
Function	F-I	F-II	F-III
Hazard	H-I	H-II	H-III
Importance Factor	I = 1.0	I = 1.25	I = 1.5

Address each of the issues implied in the matrix:

- Seismic Use Group: Neither the structure nor the contents are critical, therefore use Seismic Use Group I.
- Function: The water storage tank is neither a designated ancillary structure for post-earthquake recovery, nor identified as an emergency back-up facilities for a Seismic Use Group III structure, therefore use F-I.
- Hazard: The contents are not hazardous, therefore use H-I.
- This tank has an importance factor of 1.0.

Example 2. A steel storage rack is located in a retail store in which the customers have direct access to the aisles. Merchandise is stored on the upper racks. The rack is supported by a slab on grade.

Table 14.2-1 Seismic Use Groups and Importance Factors for Nonbuilding Structures

Seismic Use Group	I	II	III
Function	F-I	F-II	F-III
Hazard	H-I	H-II	H-III
Importance Factor	I = 1.0	I = 1.25	I = 1.5

Address each of the issues in the matrix:

- Seismic Use Group: Neither the structure nor the contents are critical, therefore use Seismic Use Group I.
- Function: The storage rack is neither used for post-earthquake recovery, nor required for emergency back-up, therefore use F-I.
- Hazard: The contents are not hazardous. However, its use could cause a substantial public hazard during an earthquake. Subject to the local authority's jurisdiction it is H-II.
- According to Sec. 14.3.5.2 the importance factor for storage racks in occupancies open to the general public must be taken as 1.5.
- Use an importance factor of 1.5 for this structure.

Example 3. A water tank is located within an office building complex to supply the fire sprinkler system.

Table 14.2-1 Seismic Use Groups and Importance Factors for Nonbuilding Structures

Seismic Use Group	I	II	III
Function	F-I	F-II	F-III
Hazard	H-I	H-II	H-III
Importance Factor	I = 1.0	I = 1.25	I = 1.5

Address each of the issues in the matrix:

- Seismic Use Group: The office building is assigned to Seismic Use Group I.
- Function: The water tank is required to provide water for fire fighting. However since the building is not a Seismic Use Group III structure, the water is used neither for post-earthquake recovery, nor for emergency back-up, so use F-I.
- Hazard: The content and its use are not hazardous to the public, therefore use H-I.
- Use an importance factor of 1.0 for this water structure.

Example 4. A petrochemical storage tank is to be constructed within a refinery tank farm near a populated city neighborhood. An impoundment dike is provided to control liquid spills.

Table 14.2-1 Seismic Use Groups and Importance Factors for Nonbuilding Structures

Seismic Use Group	I	II	III
Function	F-I	F-II	F-III
Hazard	H-I	H-II	H-III
Importance Factor	I = 1.0	I = 1.25	I = 1.5

Address each of the issues in the matrix:

- Seismic Use Group: The LNG tank is assigned to Seismic Use Group III.
- Function: The tank is neither required to provide post-earthquake recovery nor used for emergency back-up for a Seismic Use Group III structure, so use F-I.
- Hazard: The tank contains a substantial quantity of high explosive and is near a city neighborhood. Despite the diking, it is considered hazardous to the public in the event of an earthquake, so use H-III.
- Use an importance factor of 1.5 for this structure.

14.2.3 Design basis. The design basis for nonbuilding structures is based on either adopted references, approved standards, or these *Provisions*. It is intended that the *Provisions* applicable to buildings apply to nonbuilding structures, unless specifically noted in this Chapter.

14.2.4 Seismic force-resisting system selection and limitations. Nonbuilding structures similar to buildings may be designed in accordance with either Table 4.3-1 or Table 14.2-2, including referenced design and detailing requirements. For convenience, Table 4.3-1 requirements are repeated in Table 14.2-2.

Table 14.2-2 of the 2000 NEHRP Provisions for nonbuilding structures similar to buildings prescribed R , Ω_o , and C_d values to be taken from Table 4.3-1, but prescribed less restrictive height limitations than those prescribed in Table 4.3-1. This inconsistency has been corrected. Nonbuilding structures similar to buildings which use the same R , Ω_o , and C_d values as buildings now have the same height limits, restrictions and footnote exceptions as buildings. The only difference is that the footnote exceptions for buildings apply to metal building like systems while the exceptions for nonbuilding structures apply to pipe racks. In addition, selected nonbuilding structures similar to buildings have prescribed an option where both lower R values and less restrictive height limitations are specified. This option permits selected types of nonbuilding structures which have performed well in past earthquakes to be constructed with less restrictions in Seismic Design Categories D, E and F provided seismic detailing is used and design force levels are considerably higher. It should be noted that revised provisions are considerably more restrictive than those prescribed in Table 4.3-1.

Nonbuilding structures not similar to buildings should be designed in accordance Table 14.2-3 requirements, including referenced design and detailing requirements.

Nonbuilding structures not referenced in either Table 14.2-2, Table 14.2-3, or Table 4.3-1 may be designed in accordance with an adopted reference, including its design and detailing requirements.

It is not consistent with the intent of the *Provisions* to take design values from one table or standard and design and/or detailing provisions from another.

14.2.5 Structural analysis procedure selection. Nonbuilding structures that are similar to buildings should be subject to the same analysis procedure limitations as building structures.

Nonbuilding structures that are not similar to buildings should not be subject to these procedure limitations. However, they should be subject to any procedure limitations prescribed in specific adopted references.

For nonbuilding structures supporting flexible system components, such as pipe racks, the supported piping and platforms are generally not regarded as rigid enough to redistribute seismic forces to the supporting frames.

For nonbuilding structures supporting rigid system components, such as steam turbine generators (STG's) and Heat Recovery Steam Generators (HRSG's), the supported equipment, ductwork, and other components (depending on how they are attached to the structure) may be rigid enough to redistribute seismic forces to the supporting frames. Torsional effects may need to be considered in such situations.

14.2.9 Fundamental period. The rational methods for period calculation contained in the *Provisions* were developed for building structures. If the nonbuilding structure has dynamic characteristics similar to those of a building, the difference in period is insignificant. If the nonbuilding structure is not similar to a building structure, other techniques for period calculation will be required. Some of the references for specific types of nonbuilding structures contain more accurate methods for period determination.

Equations 5.2-6, 5.2-7, and 5.2-7 are not recommended because they are not relevant for the commonly encountered nonbuilding structures.

14.3 NONBUILDING STRUCTURES SIMILAR TO BUILDINGS

Nonbuilding structures exhibit behavior similar to that of building structures; however, their function and performance are different. Although the *Provisions* for buildings are used as the primary basis for design, this section identifies appropriate exceptions, modifications, and additions for selected nonbuilding structures similar to buildings.

14.3.1 Electrical power generating facilities. Electrical power plants closely resemble building structures, and their performance in seismic events has been good. For reasons of mechanical performance, lateral drift of the structure must be limited. The lateral bracing system of choice has been the concentrically braced frame. The height limits on braced frames in particular can be an encumbrance to the design of large power generation facilities.

14.3.3 Piers and wharves. Current industry practice recognizes the distinct differences between the two categories of piers and wharves described in the *Provisions*. The piers and wharves with public occupancy, described in paragraph (a) are commonly treated as the "foundation" for buildings or building-like structures, and design is performed using the *Provisions*. The design is likely to be under the jurisdiction of the local building official.

Piers and wharves where occupancy by the general public is not a consideration, as described in paragraph (b), are often treated differently. In many cases, they do not fall under the jurisdiction of building officials, and utilize other design approaches more common to this industry.

Economics plays a major role in the design decisions associated with these structures. These economic decisions may be affected not only by the wishes of the owners, but also by overlapping jurisdictional entities with local, regional, or state interests in commercial development.

In the cases where the Building Officials have jurisdiction, they typically do not have experience analyzing pier and wharf structures. In these instances, they have come to rely on and utilize the other design approaches that are more common in the industry.

Major ports and marine terminals in seismic regions of the world routinely design structures as described in paragraph (b). The design of these often uses a performance-based approach, with criteria and methods that are very different than those used for buildings, as provided in the *Provisions*.

Design approaches most commonly used are generally consistent with the practices and criteria described

in the following documents:

- Working Group No. 34 of the Maritime Navigation Commission (PIANC/MarCom/WG34), 2001, *Seismic Design Guidelines for Port Structures*, A. A. Balkema, Lisse, Netherlands, 2001.
- Ferritto, J., Dickenson, S., Priestley N., Werner, S., Taylor, C., Burke D., Seelig W., and Kelly, S., 1999, *Seismic Criteria for California Marine Oil Terminals*, Vol.1 and Vol.2, Technical Report TR-2103-SHR, Naval Facilities Engineering Service Center, Port Hueneme, CA.
- Priestley, N.J.N., Frieder Siebel, Gian Michele Calvi, *Seismic Design and Retrofit of Bridges*, 1996, New York.
- *Seismic Guidelines for Ports*, by the Ports Committee of the Technical Council on Lifeline Earthquake Engineering, ASCE, edited by Stuart D. Werner, Monograph No. 12, March 1998, published by ASCE, Reston, VA.
- *Marine Oil Terminal Engineering and Maintenance Standards*, California State Lands Commission, Marine Facilities Division, May 2002.

These alternative approaches have been developed over a period of many years by working groups within the industry, and consider the historical experience and performance characteristics of these structures that are very different than building structures.

The main emphasis of the performance-based design approach is to provide criteria and methods that depend on the economic importance of a facility. Adherence to the performance criteria in the documents listed above is expected to provide as least as much inherent life-safety, and likely much more, than for buildings designed using the Provisions. However, the philosophy of these criteria is not to provide uniform margins of collapse for all structures. Among the reasons for the higher inherent level of life-safety for these structures are the following:

- These structures have relatively infrequent occupancy, with few working personnel and very low density of personnel. Most of these structures consist primarily of open area, with no enclosed building structures which can collapse onto personnel. Small control buildings on marine oil terminals or similar secondary structures are commonly designed in accordance with the local building code.
- These pier or wharf structures are typically constructed of reinforced concrete, prestressed concrete, and/or steel and are highly redundant due to the large number of piles supporting a single wharf deck unit. Tests done for the Port of Los Angeles at the University of California at San Diego have shown that very high ductilities (10 or more) can be achieved in the design of these structures using practices currently used in California ports.
- Container cranes, loading arms, and other major structures or equipment on the piers or wharves are specifically designed not to collapse in an earthquake. Typically, additional piles and structural members are incorporated into the wharf or pier specifically to support that item.
- Experience has shown that seismic “failure” of wharf structures in zones of strong seismicity is indicated not by collapse, but by economically unreparable deformations of the piles. The wharf deck generally remains level or slightly tilting but shifted out of position. Complete failure that could cause life-safety concerns has not been known to ever occur historically due to earthquake loading.

- The performance-based criteria of the listed documents include repairability of the structure. This service level is much more stringent than collapse prevention and would provide a greater margin for life-safety.
- Lateral load design of these structures is often governed by other marine loading conditions, such as mooring or berthing.

14.3.4 Pipe racks. Free standing pipe racks supported at or below grade with framing systems that are similar in configuration to building systems should be designed to satisfy the force requirements of Sec. 5.2. Single column pipe racks that resist lateral loads should be designed as inverted pendulums. See ASCE Petro.

14.3.5 Steel storage racks. This section is intended to assure comparable results from the use of the RMI Specification, the NEHRP *Provisions*, and the IBC code approaches to rack structural design.

For many years the RMI has been working with the various committees of the model code organizations and with the Building Seismic Safety Council and its Technical Subcommittees to create seismic design provisions particularly applicable to steel storage rack structures. The 1997 RMI Specification is seen to be in concert with the needs, provisions, and design intent of the building codes and those who use and promulgate them, as well as those who engineer, manufacture, install, operate, use, and maintain rack structures. The RMI Specification, now including detailed seismic provisions, is essentially self-sufficient.

The changes proposed here are compatible and coordinated with those in the 2000 *International Building Code*.

14.3.5.2 Importance factor. Until recently, storage racks were primarily installed in low-occupancy warehouses. With the recent proliferation of warehouse-type retail stores, it has been judged necessary to address the relatively greater seismic risk that storage racks may pose to the general public, compared to more conventional retail environments. Under normal operating conditions, retail stores have a far higher occupancy load than an ordinary warehouse of a reasonable size. Failure of a storage rack system in the retail environment is much more likely to cause personal injury than a similar failure in a storage warehouse. Therefore, to provide an appropriate level of additional safety in areas open to the public, Sec 14.3.5.2 now requires that storage racks in occupancies open to the general public be designed with an importance factor equal to 1.50. Storage rack contents, while beyond the scope of the *Provisions*, pose a potentially serious threat to life should they fall from the shelves in an earthquake. Restraints should be provided to prevent the contents of rack shelving open to the general public from falling in strong ground shaking.

14.4 NONBUILDING STRUCTURES NOT SIMILAR TO BUILDINGS

Nonbuilding structures not similar to buildings exhibit behavior markedly different from that of building structures. Most of these types of structures have adopted references that address their unique structural performance and behavior. The ground motion in the *Provisions* requires appropriate translation to allow use with industry standards. Such translation is provided in this section.

14.4.2 Earth retaining structures. In order to properly develop and implement methodologies for the design of earth retaining structures, it is essential to know and understand the nature of the applied loads. Concerns have been raised concerning the design of nonyielding walls and yielding walls for bending, overturning, sliding, etc., taking into account the varying soil types, importance, and site seismicity. See Sec. 7.5.1 in the *Commentary*.

14.4.3 Stacks and chimneys. The design of stacks and chimneys to resist natural hazards is generally governed by wind design considerations. The exceptions to this general rule involve locations with high seismicity, stacks and chimneys with large elevated masses, and stacks and chimneys with unusual geometries. It is prudent to evaluate the effect of seismic loads in all but those areas with the lowest seismicity. Although not specifically required, it is recommended that the special seismic details required elsewhere in the *Provisions* be evaluated for applicability to stacks and chimneys.

Guyed steel stacks and chimneys are generally light weight. As a result, the design loads due to natural hazards are generally governed by wind. On occasion, large flares or other elevated masses located near the top may require an in-depth seismic analysis. Although Chapter 6 of Troitsky does not specifically address seismic loading, it remains an applicable methodology for resolution of seismic forces that are defined in these *Provisions*.

14.4.7 Tanks and vessels. Methods of seismic design of tanks, currently adopted by a number of industry standards, have evolved from earlier analytical work by Jacobsen, Housner, Veletsos, Haroun, and others. The procedures used to design flat bottom storage tanks and liquid containers is based on the work of Housner, Wozniak, and Mitchell. The standards for tanks and vessels have specific requirements to safeguard against catastrophic failure of the primary structure based on observed behavior in seismic events since the 1930s. Other methods of analysis using flexible shell models have been proposed but are presently beyond the scope of these *Provisions*.

These methods entail three fundamental steps:

1. The dynamic modeling of the structure and its contents. When a liquid-filled tank is subjected to ground acceleration, the lower portion of the contained liquid, identified as the impulsive component of mass W_I , acts as if it were a solid mass rigidly attached to the tank wall. As this mass accelerates, it exerts a horizontal force, P_I , against the wall that is directly proportional to the maximum acceleration of the tank base. This force is superimposed on the inertia force of the accelerating wall itself, P_w . Under the influence of the same ground acceleration, the upper portion of the contained liquid responds as if it were a solid mass flexibly attached to the tank wall. This portion, which oscillates at its own natural frequency, is identified as the convective component W_c , and exerts a force P_c on the wall. The convective component oscillations are characterized by the phenomenon of sloshing whereby the liquid surface rises above the static level on one side of the tank, and drops below that level on the other.
2. The determination of the frequency of vibration, w_I , of the tank structure and the impulsive component; and the natural frequency of oscillation (sloshing), w_c , of the convective component.
3. The selection of the design response spectrum. The response spectrum may be site-specific or it may be constructed deterministically on the basis of seismic coefficients given in national codes and standards. Once the design response spectrum is constructed, the spectral accelerations corresponding to w_I and w_c are obtained and are used to calculate the dynamic forces P_I , P_w , and P_c .

Detailed guidelines for the seismic design of circular tanks, incorporating these concepts to varying degrees, have been the province of at least four industry standards: AWWA D100 for welded steel tanks (since 1964); API 650 for petroleum storage tanks; AWWA D110 for prestressed, wire-wrapped tanks (since 1986); and AWWA D115 for prestressed concrete tanks stressed with tendons (since 1995). In addition, API 650 and API 620 contain provisions for petroleum, petrochemical, and cryogenic storage tanks. The detail and rigor of analysis employed by these standards have evolved from a semi-static approach in the early editions to a more rigorous approach at the present, reflecting the need to factor in the dynamic properties of these structures.

The requirements in Sec 14.4.7 are intended to link the latest procedures for determining design level seismic loads with the allowable stress design procedures based on the methods in these *Provisions*. These requirements, which in many cases identify specific substitutions to be made in the design equations of the national standards, will assist users of the *Provisions* in making consistent interpretations.

ACI has published a document, ACI 350.3-01 titled “*Seismic Design of Liquid-Containing Concrete Structures.*” This document, which covers all types of concrete tanks (prestressed and non-prestressed, circular and rectilinear), has provisions made consistent with the seismic guidelines of the 2000 *Provisions*. This ACI document serves as both a practical “how-to” loading reference and a guide to supplement application of Chapter 21 “Special Provisions for Seismic Design” of ACI 318.

14.4.7.1 Design basis. Two important tasks of TS 13 were (a) to partially expand the coverage of nonbuilding structures in the *Provisions*; and (b) to provide comprehensive cross-references to all the applicable industry standards. It is hoped that this endeavor will bring about a standardization and consistency of design practices for the benefit of both the practicing engineer and the public at large.

In the case of the seismic design of nonbuilding structures, standardization requires adjustments to industry standards to minimize existing inconsistencies among them. However, the standardization process should recognize that structures designed and built over the years in accordance with industry standards have performed well in earthquakes of varying severity.

Of the inconsistencies among industry standards, the ones most important to seismic design relate to the base shear equation. The traditional base shear takes the following form:

$$V = \frac{ZIS}{R_w} CW$$

An examination of those terms as used in the different references reveals the following:

- *ZS*: The “seismic zone coefficient,” *Z*, has been rather consistent among all the standards by virtue of the fact that it has traditionally been obtained from the seismic zone designations and maps in the model building codes.

On the other hand, the “soil profile coefficient,” *S*, does vary from one standard to another. In some standards these two terms are combined.

- *I*: The importance factor, *I*, has also varied from one standard to another, but this variation is unavoidable and understandable owing to the multitude of uses and degrees of importance of liquid-containing structures.
- *C*: The coefficient *C* represents the dynamic amplification factor that defines the shape of the design response spectrum for any given maximum ground acceleration. Since coefficient *C* is primarily a function of the frequency of vibration, inconsistencies in its derivation from one standard to another stem from at least two sources: differences in the equations for the determination of the natural frequency of vibration, and differences in the equation for the coefficient itself. (For example, for the shell/impulsive liquid component of lateral force, the steel tank standards use a constant design spectral acceleration (namely, a constant *C*) that is independent of the “impulsive” period *T*.) In addition, the value of *C* will vary depending on the damping ratio assumed for the vibrating structure (usually between 2 percent and 7 percent of critical).

Where a site-specific response spectrum is available, calculation of the coefficient *C* is not necessary – except in the case of the convective component (coefficient *C_c*) which is assumed to oscillate with 0.5 percent of critical damping, and whose period of oscillation is usually high (greater than 2.5 sec). Since site-specific spectra are usually constructed for high damping values (3 percent to 7 percent of critical); and since the site-specific spectral profile may not be well-defined in the high-period range, an equation for *C_c* applicable to a 0.5 percent damping ratio is necessary in order to calculate the convective component of the seismic force.

- *R_w*: The “response modification factor,” *R_w*, is perhaps the most difficult to quantify, for a number of reasons. While *R_w* is a compound coefficient that is supposed to reflect the ductility, energy-dissipating capacity, and redundancy of the structure, it is also influenced by serviceability considerations, particularly in the case of liquid-containing structures.

In the *Provisions* the base shear equation for most structures has been reduced to $V = C_s W$, where the seismic response coefficient, *C_s*, replaces the product $\frac{ZSC}{R_w}$. *C_s* is determined from the design spectral

response acceleration parameters *S_{DS}* and *S_{D1}* (at short periods and at a period of 1 sec, respectively) which, in turn, are obtained from the mapped MCE spectral accelerations *S_s* and *S₁* obtained from the

seismic maps. As in the case of the prevailing industry standards, where a site-specific response spectrum is available, C_s is replaced by the actual spectral values of that spectrum.

As part of its task, TS 13 has introduced a number of provisions, in the form of bridging equations, each designed to provide a means of properly applying the design criteria of a particular industry standard in the context of these *Provisions*. These provisions are outlined below and are identified with particular types of liquid-containing structures and the corresponding standards. Underlying all these provisions is the understanding that the calculation of the periods of vibration of the impulsive and convective components is left up to the industry standards. Defining the detailed resistance and allowable stresses of the structural elements for each industry structure has also been left to the approved standard except in instances where additional information has led to additional requirements.

It is intended that, as the relevant national standards are updated to conform to these *Provisions*, the “bridging” equations of Sec. 14.4.7.6, 14.4.7.7, and 14.4.7.9 will be eliminated.

14.4.7.2 Strength and ductility. As is the case for building structures, ductility and redundancy in the lateral support systems for tanks and vessels are desirable and necessary for good seismic performance. Tanks and vessels are not highly redundant structural systems and, therefore, ductile materials and well-designed connection details are needed to increase the capacity of the vessel to absorb more energy without failure. The critical performance of many tanks and vessels is governed by shell stability requirements rather than by yielding of the structural elements. For example, contrary to building structures, ductile stretching of the anchor bolts is a desirable energy absorption component when tanks and vessels are anchored. The performance of cross-braced towers is highly dependent on the ability of the horizontal compression struts and connection details to fully develop the tension yielding in the rods. In such cases, it is also important to assure that the rods stretch rather than fail prematurely in the threaded portion of the connection and that the connection of the rod to the column does not fail prior to yielding of the rod.

14.4.7.3 Flexibility of piping attachments. The performance of piping connections under seismic deformations is one of the primary weaknesses observed in recent seismic events. Tank leakage and damage occurs when the piping connections cannot accommodate the movements the tank experiences during the a seismic event. Unlike the connection details used by many piping designers, which connections impart mechanical loading to the tank shell, piping systems in seismic areas should be designed in such a manner as to impose only negligible mechanical loads on the tank connection for the values shown in Table 14.4-1.

In addition, interconnected equipment, walkways, and bridging between multiple tanks must be designed to resist the loads and displacements imposed by seismic forces. Unless multiple tanks are founded on a single rigid foundation, walkways, piping, bridges, and other connecting structures must be designed to allow for the calculated differential movements between connected structures due to seismic loading assuming the tanks and vessels respond out of phase.

14.4.7.4 Anchorage. Many steel tanks can be designed without anchors by using the annular plate procedures given in the national standards. Tanks that must be anchored because of overturning potential could be susceptible to shell tearing if not properly designed. Ideally, the proper anchorage design will provide both a shell attachment and embedment detail that will yield the bolt without tearing the shell or pulling the bolt out the foundation. Properly designed anchored tanks retain greater reserve strength to resist seismic overload than do unanchored tanks.

Premature failure of anchor bolts has been observed where the bolt and attachment are not properly aligned (that is, the anchor nut or washer does not bear evenly on the attachment). Additional bending stresses in threaded areas may cause the anchor to fail before yielding.

14.4.7.5 Ground-supported storage tanks for liquids

14.4.7.5.1 Seismic forces. The response of ground storage tanks to earthquakes is well documented by Housner, Mitchell and Wozniak, Veletsos, and others. Unlike building structures, the structural response

is strongly influenced by the fluid-structure interaction. Fluid-structure interaction forces are categorized as sloshing (convective mass) and rigid (impulsive mass) forces. The proportion of these forces depends on the geometry (height-to-diameter ratio) of the tank. API 650, API 620, AWWA D100, AWWA D110, AWWA D115, and ACI 350.3 provide the necessary data to determine the relative masses and moments for each of these contributions.

The *Provisions* stipulate that these structures shall be designed in accordance with the prevailing approved industry standards, with the exception of the height of the sloshing wave, d_s , which is to be calculated using Eq. 14.4-9 of these *Provisions*.

$$\delta_s = 0.5DIS_{ac}$$

This equation utilizes a spectral response coefficient $S_{ac} = \frac{1.5S_{D1}}{T_c}$ for $T_c < 4.0$ sec., and $S_{ac} = \frac{6S_{D1}}{T_c^2}$ for

$T_c > 4.0$ sec. The first definition of S_a represents the constant-velocity region of the response spectrum and the second the constant-displacement region of the response spectrum, both at 0.5 percent damping. In practical terms, the latter is the more commonly used definition since most tanks have a fundamental period of liquid oscillation (sloshing wave period) greater than 4.0 sec.

Small diameter tanks and vessels are more susceptible to overturning and vertical buckling. As a general rule, the greater the ratio of H/D , the lower the resistance is to vertical buckling. When $H/D > 2$, the overturning begins to approach “rigid mass” behavior (the sloshing mass is small). Large diameter tanks may be governed by additional hydrodynamic hoop stresses in the middle regions of the shell.

The impulsive period (the natural period of the tank components and the impulsive component of the liquid) is typically in the 0.25 to 0.6 second range. Many methods are available for calculating the impulsive period. The Veletsos flexible-shell method is commonly used by many tank designers. (For example, see “Seismic Effects in Flexible Liquid Storage Tanks” by A. S. Veletsos.)

14.4.7.5.2 Distribution of hydrodynamic and inertia forces. Most of the methods contained in the industry standards for tanks define reaction loads at the base of the shell and foundation interface. Many of the standards do not give specific guidance for determining the distribution of the loads on the shell as a function of height. The design professional may find the additional information contained in ACI 350.3 helpful.

The overturning moment at the base of the shell as defined in the industry standards is only the portion of the moment that is transferred to the shell. It is important for the design professional to realize that the total overturning moment must also include the variation in bottom pressure. This is important when designing pile caps, slabs, or other support elements that must resist the total overturning moment. See Wozniak or TID 7024 for further information.

14.4.7.5.3 Freeboard. Performance of ground storage tanks in past earthquakes has indicated that sloshing of the contents can cause leakage and damage to the roof and internal components. While the effect of sloshing often involves only the cost and inconvenience of making repairs, rather than catastrophic failure, even this limited damage can be prevented or significantly mitigated when the following items are considered:

1. Effective masses and hydro-dynamic forces in the container.
2. Impulsive and pressure loads at
 - a. Sloshing zone (that is, the upper shell and edge of the roof system),
 - b. Internal supports (roof support columns, tray-supports, etc.), and
 - c. Equipment (distribution rings, access tubes, pump wells, risers, etc.).
3. Freeboard (which depends on the sloshing wave height).

A minimum freeboard of $0.7\delta_s$ is recommended for economic considerations but is not required.

Tanks and vessels storing biologically or environmentally benign materials do not typically require freeboard to protect the public health and safety. However, providing freeboard in areas of frequent seismic occurrence for vessels normally operated at or near top capacity may lessen damage (and the cost of subsequent repairs) to the roof and upper container.

The estimate given in the Provision Sec. 14.4.7.5.3 is based on the seismic design event as defined by the Provisions. Users of the Provisions may estimate slosh heights different from those recommended in the national standards.

If sloshing is restricted because the freeboard provided is less than the computed sloshing height, δ_s , the sloshing liquid will impinge on the roof in the vicinity of the roof-to-wall joint, subjecting it to a hydrodynamic force. This force may be approximated by considering the sloshing wave as a hypothetical static liquid column having a height, δ_s . The pressure exerted on any point along the roof at a distance y_s above the at-rest surface of the stored liquid, may be assumed equal to the hydrostatic pressure exerted by the hypothetical liquid column at a distance $\delta_s - y_s$ from the top of that column

Another effect of a less-than-full freeboard is that the restricted convective (sloshing) mass “converts” into an impulsive mass thus increasing the impulsive forces. This effect should be taken account in the tank design. Preferably, sufficient freeboard should be provided whenever possible to accommodate the full sloshing height.

14.4.7.5.6 Sliding resistance. Steel ground-supported tanks full of product have not been found to slide off foundations. A few unanchored, empty tanks have moved laterally during earthquake ground shaking. In most cases, these tanks may be returned to their proper locations. Resistance to sliding is obtained from the frictional resistance between the steel bottom and the sand cushion on which bottoms are placed. Because tank bottoms usually are crowned upward toward the tank center and are constructed of overlapping, fillet-welded, individual steel plates (resulting in a rough bottom), it is reasonably conservative to take the ultimate coefficient of friction as 0.70 (U.S. Nuclear Regulatory Commission, 1989, pg. A-50) and, therefore, a value of $\tan 30^\circ (= 0.577)$ is used. The vertical weight of the tank and contents as reduced by the component of vertical acceleration provides the net vertical load. An orthogonal combination of vertical and horizontal seismic forces following the procedure in Sec. 5.2 may be used.

14.4.7.5.7 Local shear transfer. The transfer of seismic shear from the roof to the shell and from the shell to the base is accomplished by a combination of membrane shear and radial shear in the wall of the tank. For steel tanks, the radial shear is very small and is usually neglected; thus, the shear is assumed to be carried totally by membrane shear. For concrete walls and shells, which have a greater radial shear stiffness, the shear transfer may be shared. The user is referred to the ACI 350 commentary for further discussion.

14.4.7.5.8 Pressure stability. Internal pressure may increase the critical buckling capacity of a shell. Provision to include pressure stability in determining the buckling resistance of the shell for overturning loads is included in AWWA D100. Recent testing on conical and cylindrical shells with internal pressure yielded a design methodology for resisting permanent loads in addition to temporary wind and seismic loads. See Miller et al., 1997.

14.4.7.5.9 Shell support. Anchored steel tanks should be shimmed and grouted to provide proper support for the shell and to reduce impact on the anchor bolts under reversible loads. The high bearing pressures on the toe of the tank shell may cause inelastic deformations in compressible material (such as fiberboard), creating a gap between the anchor and the attachment. As the load reverses, the bolt is no longer snug and an impact of the attachment on the anchor can occur. Grout is a structural element and should be installed and inspected as if it is an important part of the vertical- and lateral-force-resisting system.

14.4.7.5.10 Repair, alteration, or reconstruction. During their service life, storage tanks are frequently repaired, modified or relocated. Repairs or often related to corrosion, improper operation, or overload

from wind or seismic events. Modifications are made for changes in service, updates to safety equipment for changing regulations, installation of additional process piping connections. It is imperative these repairs and modifications are properly designed and implemented to maintain the structural integrity of the tank or vessel for seismic loads as well as the design operating loads.

The petroleum steel tank industry has developed specific guidelines in API 653 that are statutory requirements in some states. It is the intent of TS 13 that the provisions of API 653 also be applied to other liquid storage tanks (water, wastewater, chemical, etc.) as it relates to repairs, modifications or relocation that affects the pressure boundary or lateral force resisting system of the tank or vessel.

14.4.7.6 Water and water treatment structures

14.4.7.6.1 Welded steel. The AWWA design requirements for ground-supported steel water storage structures are based on an allowable stress method that utilizes an effective mass procedure considering two response modes for the tank and its contents:

1. The high-frequency amplified response to seismic motion of the tank shell, roof, and impulsive mass (that portion of liquid content of the tank that moves in unison with the shell), and
2. The low-frequency amplified response of the convective mass (that portion of the liquid contents in the fundamental sloshing mode).

The two-part AWWA equation incorporates the above modes, appropriate damping, site amplification, allowable stress response modification, and zone coefficients. In practice, the typical ground storage tank and impulsive contents will have a natural period, T , of 0.1 to 0.3 sec. The sloshing period typically will be greater than 1 sec (usually 3 to 5 seconds depending on tank geometry). Thus, the substitution in the *Provisions* uses a short- and long-period response as it applies to the appropriate constituent term in the AWWA equations.

14.4.7.6.2 Bolted steel. The AWWA Steel Tank Committee is responsible for the content of both the AWWA D100 and D103 and have established equivalent load and design criteria for earthquake design of welded and bolted steel tanks.

14.4.7.7 Petrochemical and industrial liquids

14.4.7.7.1 Welded steel. The American Petroleum Institute (API) also uses an allowable stress design procedure and the API equation has incorporated an R_w factor into the equations directly.

The most common damage to tanks observed during past earthquakes include:

- Buckling of the tank shell near the base due to excessive axial membrane forces. This buckling damage is usually evident as “elephant foot” buckles a short distance above the base, or as diamond shaped buckles in the lower ring. Buckling of the upper ring has also been observed.
- Damage to the roof due to impingement on the underside of the roof of sloshing liquid with insufficient freeboard.
- Failure of piping or other attachments that are overly restrained..
- Foundation failures.

The performance of floating roofs during earthquakes has been good, with damage usually confined to the rim seals, gage poles, and ladders. Similarly the performance of open tops with top wind girder stiffeners designed per API 650 has been good.

14.4.7.9 Elevated tanks for liquids and granular materials. There are three basic lateral-load resisting systems for elevated water tanks that are defined by their support structure. Multi-leg braced steel tanks (trussed towers), small diameter single-pedestal steel tanks (cantilever columns), and large diameter single-pedestal tanks of steel or concrete construction (load-bearing shear walls). Unbraced multi-leg tanks are not commonly built. Behavior, redundancy, and resistance to overload of these types of tanks are not the same. Multi-leg and small diameter pedestal have higher fundamental periods (typically over 2-sec) than the shear wall type tanks (typically under 2-sec). Lateral load failure mechanism is usually by

bracing failure for multi-leg tanks, compression buckling of small diameter steel tanks, compression or shear buckling of large diameter steel tanks, and shear failure of large diameter concrete tanks. In order to utilize the full strength of these structures adequate connection, welding, and reinforcement details must be provided. The R-factor used with elevated tanks is typically less than that for comparable lateral load-resisting systems for other purposes in order to provide a greater margin of safety.

14.4.7.9.3 Transfer of lateral forces into support tower. The lateral transfer of load for tanks and vessels siting on grillage or support beams should consider the relative stiffness of the support beams and the shear transfer at the base of the shell, which is not typically uniform around the base of the tank. In addition, when tanks and vessels are supported on discrete points on grillage or beams, it is common for the vertical loads to vary due to settlements or variations in construction. This variation in load should be considered when analyzing the combined vertical and horizontal loads.

14.4.7.9.4 Evaluation of structures sensitive to buckling failure. Nonbuilding structures that have low or negligible structural redundancy for lateral loads need to be evaluated for a critical level of performance to provide sufficient margin against premature failure. Reserve strength for loads beyond the design loads can be limited. Tanks and vessels supported on shell skirts or pedestals that are governed by buckling are examples of structures that need to be evaluated at this critical condition. Such structures include single pedestal water towers, process vessels, and other single member towers.

The additional evaluation is based on a scaled maximum considered earthquake. This critical earthquake acceleration is defined as the design spectral response acceleration, S_w , which includes site factors. The I/R coefficient is taken as 1.0 for this critical check. The structural capacity of the shell is taken as the critical buckling strength (that is, the factor of safety is 1.0). Vertical or orthogonal earthquake combination need not be made for this critical evaluation since the probability of critical peak values occurring simultaneously is very low.

14.4.7.9.6 Concrete pedestal (composite) tanks. A composite elevated water-storage tank is a structure comprising a welded steel tank for watertight containment, a single pedestal concrete support structure, foundation, and accessories. Lateral load-resisting system is that of a load-bearing concrete shear wall. Seismic provisions in ATC 371R-98 are based on ASCE 7-95, which used NEHRP 1994 as the source document. Seismic provisions in the proposed AWWA standard being prepared by committee D170 are based on ASCE 7-98, which used NEHRP 1997 as the source document.

This page is intentionally left blank.

Appendix to Chapter 14

OTHER NONBUILDING STRUCTURES

PREFACE: The following sections were originally intended to be part of the Nonbuilding Structures Chapter of this Commentary. The *Provisions* Update Committee felt that given the complexity of the issues, the varied nature of the resource documents, and the lack of supporting consensus resource documents, time did not allow a sufficient review of the proposed sections required for inclusion into the main body of the chapter.

The Nonbuilding Structures Technical Subcommittee, however, expressed that what is presented herein represents the current industry accepted design practice within the engineering community that specializes in these types of nonbuilding structures.

The *Commentary* sections are included here so that the design community specializing in these nonbuilding structures can have the opportunity to gain a familiarity with the concepts, update their standards, and send comments on this appendix to the BSSC.

It is hoped that the various consensus design standards will be updated to include the design and construction methodology presented in this Appendix. It is also hoped that industry standards that are currently not consensus documents will endeavor to move their standards through the consensus process facilitating building code inclusion.

A14.1 GENERAL

Agrawal P. K., and J. M. Kramer, Analysis of Transmission Structures and Substation Structures and Equipment for Seismic Loading, Sargent & Lundy Transmission and Substation Conference, December 2, 1976. (Agrawal)

American Society of Civil Engineers (ASCE):

ANSI/ASCE 10, *Design of Latticed Transmission Structures*, 1997. (ASCE 10)

ASCE Manual 72, *Tubular Pole Design Standard*, 1991 (ASCE 72).

ASCE Manual 74, *Guidelines for Electrical Transmission Line Structural Loading*, 2000. (ASCE 74).

ASCE 7, *Minimum Design Loads for Buildings and Other Structures*, 1995. (ASCE 7).

ASCE Manual 91, *The Design of Guyed Electrical Transmission Structures*, 1997. (ASCE 91)

Substation Structure Design Guide, 2000. (ASCE Substation)

Li, H.-N., S. Wang, M. Lu, and Q. Wang, "Aseismic Calculations for Transmission Towers," *ASCE Technical Council on Lifeline Earthquake Engineering, Monograph No. 4*, August 1991. (ASCE Li)

Steinhardt, O. W., "Low Cost Seismic Strengthening of Power Systems," *Journal of The Technical Councils of ASCE*, April 1981. (ASCE Steinhardt)

Amiri, G. G. and G. G. McClure, "Seismic Response to Tall Guyed Telecommunication Towers," Paper No. 1982, Eleventh World Conference on Earthquake Engineering, Elsevier Science Ltd., 1996. (Amiri)

Australian Standards:

Australian Standard 3995, *Standard Design of Steel Lattice Towers and Masts*, 1994. (AS 3995)

Canadian Standards Association (CSA):

Antennas, Towers, and Masts, 1994. (CSA S37)

Earthquake Engineering Research Institute (EERI):

Li, H.-N., L. E. Suarez, and M. P. Singh, "Seismic Effects on High-Voltage Transmission Tower and Cable Systems," Fifth U.S. National Conference on Earthquake Engineering, 1994. (EERI Li)

Federal Emergency Management Agency (FEMA):

Earthquake Resistant Construction of Electric Transmission and Telecommunication Facilities Serving the Federal Government, FEMA Report No. 202, September 1990. (FEMA 202)

Galvez, C. A., and G. G. McClure, "A Simplified Method for Aseismic Design of Self-Supporting Latticed Telecommunication Towers," Seventh Canadian Conference on Earthquake Engineering, Montreal, 1995. (Galvez)

Institute of Electrical and Electronics Engineers (IEEE):

National Electrical Safety Code, ANSI C2, New Jersey, 1997. (NESC)

IEEE Standard 693, *Recommended Practices for Seismic Design of Substations*, Power Engineering Society, Piscataway, New Jersey, 1997 (IEEE 693).

IEEE Standard 751, *Trial-Use Design Guide for Wood Transmission Structures*, Power Engineering Society, Piscataway, New Jersey, 1991. (IEEE 751)

Long, L.W., Analysis of Seismic Effects on Transmission Structures, IEEE Paper T 73 326-6, April 1973. (IEEE Long).

Lum, W. B., N. N. Nielson, R. Koyanagi, and A. N. L. Chui, "Damage Survey of the Kasiki, Hawaii Earthquake of November 16, 1993," *Earthquake Spectra*, November 1984. (Lum)

Lyver, T. D., W. H. Mueller, and L. Kempner, Jr., *Response Modification Factor, R_w , for Transmission Towers*, Research Report, Portland State University, Portland, Oregon, 1996. (Lyver)

National Center for Earthquake Engineering Research (NCEER):

The Hanshin-Awaji Earthquake of January 17, 1995—Performance of Lifelines, National Center for Earthquake Engineering Research, Technical Report NCEER-95-0015, State University of New York at Buffalo, November 3, 1995. (NCEER 95-0015)

Rural Electrical Administration (REA):

Bulletin 1724E-200, *Design Manual for High Voltage Transmission Lines*, 1992. (REA 1724).

Bulletin 65-1, *Design Guide for Rural Substations*, 1978 (REA 65-1).

Bulletin 160-2, *Mechanical Design Manual for Overhead Distribution Lines*, 1982. (REA 160)

Telecommunications Industry Association (TIA):

TIA/EIA 222F, *Structural Standards for Steel Antenna Towers and Antenna Supporting Structures*, 1996. (TIA 222)

A14.2.1 Buried Structures. This section was placed in the Appendix to Chapter 14 for the following reasons:

1. The material may serve as a starting point for continued development.
2. The comments stimulated by consideration of this section will provide valuable input so that this section may be further developed and then incorporated in the *Provisions* in the future.
3. It was determined by TS 13 and the *Provisions* Update Committee that it would be premature to incorporate this section into the *Provisions* for the 2000 edition.
4. Accepted industry standards are in the process of incorporating seismic design methodology reflecting the *Provisions*.

It is not the intent of the *Provisions* Update Committee to discourage incorporation of this section into a building code or to minimize the importance of this section. Placing this section in the appendix indicates only that this section requires further development.

Seismic forces on buried structures may include forces due to: soil displacement, seismic lateral earth pressure, buoyant forces related to liquefaction, permanent ground displacements from slope instability, lateral spread movement, fault movement, or dynamic ground displacement caused by dynamic strains from wave propagation. Identification of appropriate seismic loading conditions is dependent upon subsurface soil conditions and the configuration of the buried structure. Conditions related to permanent ground movement can often be avoided by careful site selection for isolated buried structures such as tanks and vaults. Relocation is often impractical for long buried structures such as tunnels and pipelines.

Wave propagation strains are a significant seismic force condition for buried structures if local site conditions (for instance, deep surface soil deposits with low shear wave velocities) can support the propagation of large amplitude seismic waves. Wave propagation strains tend to be most pronounced at the junctions of dissimilar buried structures (such as a pipeline connecting with a building) or at the interfaces of different geologic materials (such as a pipeline passing from rock to soft soil).

Loading conditions related to liquefaction require detailed subsurface information that can be used to assess the potential for liquefaction and, for long buried structures, the length of structure exposed to liquefaction effects. In addition, the assessment of liquefaction requires specifying an earthquake magnitude that is consistent with the definition of ground shaking. It is recommended that one refer to Chapter 7 of this *Commentary* for additional guidance in determining liquefaction potential and seismic magnitude. Providing detailed structural design procedures in this area is beyond the scope of this document.

Loading conditions related to lateral spread movement and slope instability can be defined in terms of lateral soil pressures or prescribed ground displacements. In both cases, sufficient subsurface investigation in the vicinity of the buried structure is necessary to estimate the amount of movement, the direction of movement relative to the buried structure, and the portion of the buried structure exposed to the loading conditions. Definition of lateral spread loading conditions requires special geotechnical expertise and specific procedures in this area are beyond the scope of this document.

Defining the loading conditions for fault movement requires specific location of the fault and an estimate of the earthquake magnitude on the fault that is consistent with the ground shaking hazard in the *Provisions*. Identification of the fault location should be based on past earthquake movements, trenching studies, information from boring logs, or other accepted fault identification techniques. Defining fault movement conditions requires special seismological expertise. Additional guidance can be found in the Chapter 7 of this *Commentary*.

It may not be practically feasible to design a buried structure to resist the effects of permanent ground deformation. Alternative approaches in such cases may include relocation to avoid the condition, ground improvements to reduce the loads, or implementing special procedures or design features to minimize the impact of damage (such as remote controlled or automatic isolation valves that provide the ability to rapidly bypass damage or post-earthquake procedures to expedite repair). The goal of providing procedures or design features as an alternative to designing for the seismic loadings is to change the hazard and function classification of the buried structure such that it is not classified as Seismic Use Group II or III.

It is recommended that one refer to Chapter 7 of this *Commentary* for additional guidance in determining liquefaction potential and determining seismic magnitude.

Buried structures are subgrade structures such as tanks, tunnels, and pipes. Buried structures that are designated as Seismic Use Group II or III, or are of such a size or length to warrant special seismic design as determined by the registered design professional, must be identified in the geotechnical report.

Buried structures must be designed to resist minimum seismic lateral forces determined from a substantiated analysis using approved procedures. Flexible couplings must be provided for buried structures requiring special seismic considerations where changes in the support system, configuration, or soil condition occur.

The requirement for and value of flexible couplings should be determined by the “properly substantiated analysis and approved procedures.” It is assumed that the need for flexible couplings refers to buried piping or conduits. The prior wording of Sec. A14.2.3 was far too broad in requiring flexible couplings where changes in the support system, configuration or soil condition occur. These broad requirements could result in flexible couplings installed at locations where permanent ground displacement is expected or at transitions between aboveground supported pipe and buried pipe. As currently available flexible couplings are not generally designed to match the ultimate strength properties of the piping or conduit, the prior requirements potentially introduce a weak point in the piping or conduit system. The original focus of the prior requirements was penetrations of buried service lines into a building or other structure. Properly designed flexible couplings can be an effective means to limit forces at connections to buried structures. However, special care is needed to make sure the design loads and displacements are adequately specified. There are several other alternative to providing sufficient flexibility at connections to buried structures that are more robust in terms of margin above their design levels.

Chapter 15 Commentary

STRUCTURES WITH DAMPING SYSTEMS

Background. Chapter 15, Structures with Damping Systems, appears for the first time in the body of the 2003 *Provisions*, having first appeared as an appendix (to Chapter 13) in the 2000 *Provisions*. The appendix was developed by Technical Subcommittee 12 (TS 12) of the Provision Update Committee (PUC) during the 2000 update cycle to provide a basis for designing structures with damping systems that is consistent with the *NEHRP Provisions*, in particular structures with seismic (base) isolation systems. Voting members of TS 12 during the 2000 update were Dr. Charles Kircher (TS 12 Chair and PUC representative), Dr. Michael Constantinou (PUC representative), Dr. Ian Aiken, Dr. Robert Hanson, Mr. Martin Johnson, Dr. Andrew Taylor, and Dr. Andrew Whittaker

During the 2000 update cycle, the primary resource documents for the design of structures with dampers were the *NEHRP Guidelines for Seismic Rehabilitation of Buildings* (FEMA 273, 1997) and the *NEHRP Commentary on the Guidelines for the Seismic Rehabilitation of Buildings* (FEMA 274, 1997). While suitable for the performance-based design, terms, methods of analysis and response limits of the *NEHRP Guidelines* for existing buildings do not match those of the *NEHRP Provisions* for new structures. Accordingly, TS-12 developed new provisions, in particular new linear analysis methods, for design of structures with dampers.

New analysis methods were developed for structures with dampers based on nonlinear “pushover” characterization of the structure and calculation of peak response using effective (secant) stiffness and effective damping properties of the first (pushover) mode in the direction of interest. These are same concepts used in Chapter 13 to characterize the force-deflection properties of isolation systems, modified to explicitly incorporate the effects of ductility demand (post-yield response) and higher-mode response of structures with dampers. In contrast to isolated structures, structures with dampers are in general expected to yield during strong ground shaking (similar to conventional structures), and their performance can be significantly influenced by response of higher modes.

During the 2000 cycle, analysis methods were evaluated using design examples. Response calculated using linear analysis was found to compare well with the results of nonlinear time history analysis (Ramirez, 2001). Additional design examples illustrating explicit “pushover” modeling of the structure may be found in Chapter 9 commentary of FEMA 274. The reader is also referred to Ramirez et al. (2002a, 2002b, 2003) and Whittaker et al. (2003) for a detailed exposition of the analysis procedures in this chapter, background research studies, examples of application and an evaluation of accuracy of the linear static and response spectrum analysis methods.

The balance of this section provides background on the underlying philosophy used by TS12 to develop the chapter, the definition the damping system, the concept of effective damping, and the calculation of earthquake response using either linear or nonlinear analysis methods.

Design Philosophy. The basic approach taken by TS12 in developing the chapter for structures with damping systems is based on the following concepts:

1. The chapter is applicable to all types of damping systems, including both displacement-dependent damping devices of hysteretic or friction systems and velocity-dependent damping devices of viscous or visco elastic systems (Constantinou et al. 1998, Hanson and Soong, 2001)
2. The chapter provides minimum design criteria with performance objectives comparable to those for a structure with a conventional seismic-force-resisting system (but also permits design criteria that will achieve higher performance levels).

3. The chapter requires structures with a damping system to have a seismic-force-resisting system that provides a complete load path. The seismic-force-resisting system must comply with the requirements of the *Provisions*, except that the damping system may be used to meet drift limits.
4. The chapter requires design of damping devices and prototype testing of damper units for displacements, velocities, and forces corresponding to those of the maximum considered earthquake (same approach as that used for structures with an isolation system).
5. The chapter provides linear static and response spectrum analysis methods for design of most structures that meet certain configuration and other limiting criteria (for example, at least two damping devices at each story configured to resist torsion). The chapter requires additional nonlinear response history analysis to confirm peak response for structures not meeting the criteria for linear analysis (and for structures close to major faults).

Damping system. The chapter defines the damping system as:

“The collection of structural elements that includes all individual damping devices, all structural elements or bracing required to transfer forces from damping devices to the base of the structure, and all structural elements required to transfer forces from damping devices to the seismic-force-resisting system.”

The damping system is defined separately from the seismic-force-resisting system, although the two systems may have common elements. As illustrated in Figure C15-1, the damping system may be external or internal to the structure and may have no shared elements, some shared elements, or all elements in common with the seismic-force-resisting system. Elements common to the damping system and the seismic-force-resisting system must be designed for a combination of the two loads of the two systems.

The seismic-force-resisting system may be thought of as a collection of lateral-force-resisting elements of the structure if the damping system was not functional (as if damping devices were disconnected). This system is required to be designed for not less than 75 percent of the base shear of a conventional structure (not less than 100 percent, if the structure is highly irregular), using an *R* factor as defined in Table 4.3-1. This system provides both a safety net against damping system malfunction as well as the stiffness and strength necessary for the balanced lateral displacement of the damped structure.

The chapter requires the damping system to be designed for the actual (non-reduced) earthquake forces (such as, peak force occurring in damping devices). For certain elements of the damping system, other than damping devices, limited yielding is permitted provided such behavior does not affect damping system function or exceed the amount permitted by the *Provisions* for elements of conventional structures.

The chapter defines a damping device as:

“A flexible structural element of the damping system that dissipates energy due to relative motion of each end of the device. Damping devices include all pins, bolts, gusset plates, brace extensions, and other components required to connect damping devices to other elements of the structure. Damping devices may be classified as either displacement-dependent or velocity-dependent, or a combination thereof, and may be configured to act in either a linear or nonlinear manner.”

Following the same approach as that used for design of seismic isolators, damping devices must be designed for maximum considered earthquake displacements, velocities, and forces. Likewise, prototype damper units must be fully tested to demonstrate adequacy for maximum considered earthquake loads and to establish design properties (such as effective damping).

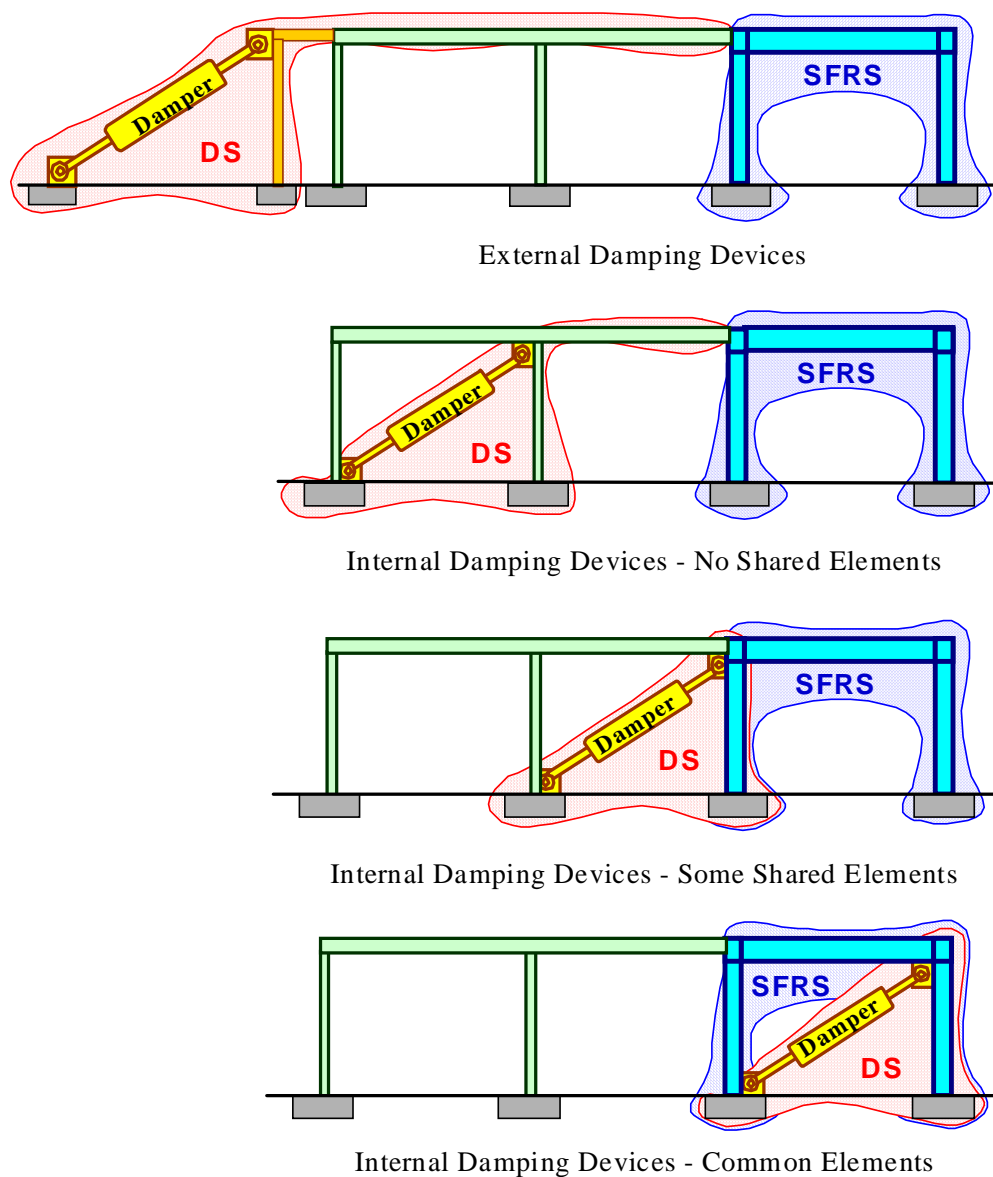

Figure C15-1. Damping system (DS) and seismic-force-resisting system (SFRS) configurations.

Effective Damping. The chapter reduces the response of a structure with a damping system by the damping coefficient, B , based on the effective damping, β , of the mode of interest. This is the same approach as that used by the *Provisions* for isolated structures. Values of the B coefficient recommended for design of damped structures are the same as those in the *Provisions* for isolated structures at damping levels up to 30 percent, but now extend to higher damping levels based on the results presented in Ramirez et al. (2001). Like isolation, effective damping of the fundamental-mode of a damped structure is based on the nonlinear force-deflection properties of the structure. For use with linear analysis methods, nonlinear properties of the structure are inferred from overstrength, Ω_0 , and other terms of the *Provisions*. For nonlinear analysis methods, properties of the structure would be based on explicit modeling of the post-yield behavior of elements.

Figure C15-2 illustrates reduction in design earthquake response of the fundamental mode due to effective damping coefficient, B_{1D} . The capacity curve is a plot of the nonlinear behavior of the

mode. The residual mode is a new concept used to approximate the combined effects of higher modes. While typically of secondary importance to story drift, higher modes can be a significant contributor to story velocity and hence are important for design of velocity-dependent damping devices. For response spectrum analysis, higher modes are explicitly evaluated.

For both the ELF and the response spectrum analysis procedures, response in the fundamental mode in the direction of interest is based on assumed nonlinear (pushover) properties of the structure. Nonlinear (pushover) properties, expressed in terms of base shear and roof displacement, are related to building capacity, expressed in terms of spectral coordinates, using mass participation and other fundamental-mode factors shown in Figure C15-3. The conversion concepts and factors shown in Figure C15-3 are the same as those defined in Chapter 9 of *NEHRP Guidelines for the Seismic Rehabilitation of Buildings* (FEMA 273), which addresses seismic rehabilitation of a structure with damping devices.

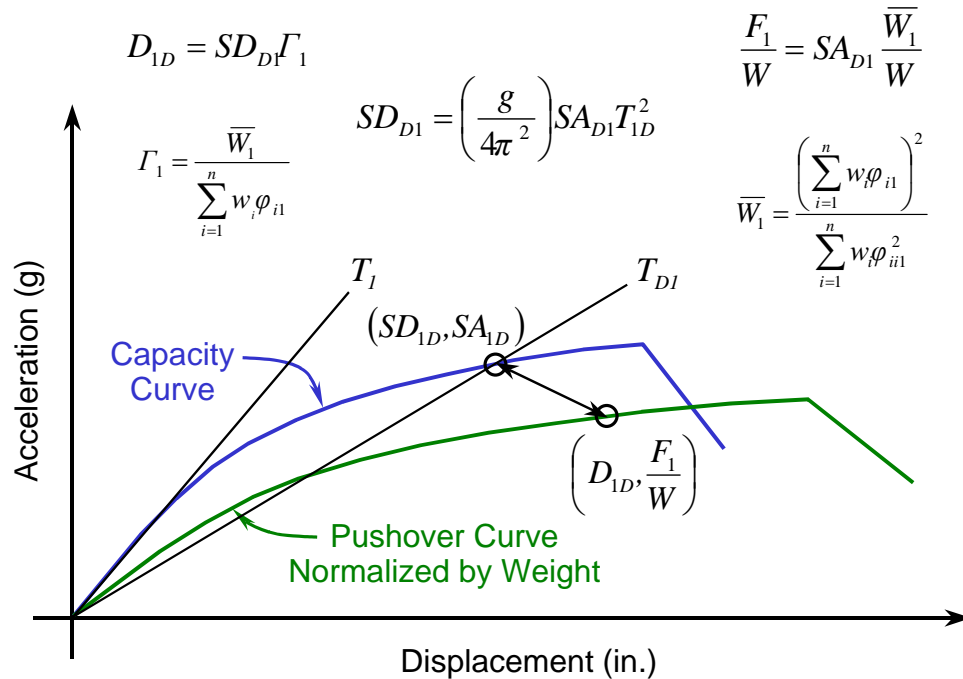

Figure C15-3. Pushover and capacity curves.

When using linear analysis methods, the shape of the fundamental-mode pushover curve is not known and an idealized elasto-plastic shape is assumed, as shown in Figure C15-4. The idealized pushover curve shares a common point with the actual pushover curve at the design earthquake displacement, D_{1D} . The idealized curve permits defining global ductility demand due to the design earthquake, μ_D , as the ratio of design displacement, D_{1D} , to the yield displacement, D_y . This ductility factor is used to calculate various design factors and to set limits on the building ductility demand, μ_{max} , which limits are consistent with conventional building response limits. Design examples using linear analysis methods have been developed and found to compare well with the results of nonlinear time history analysis (Ramirez et al., 2001).

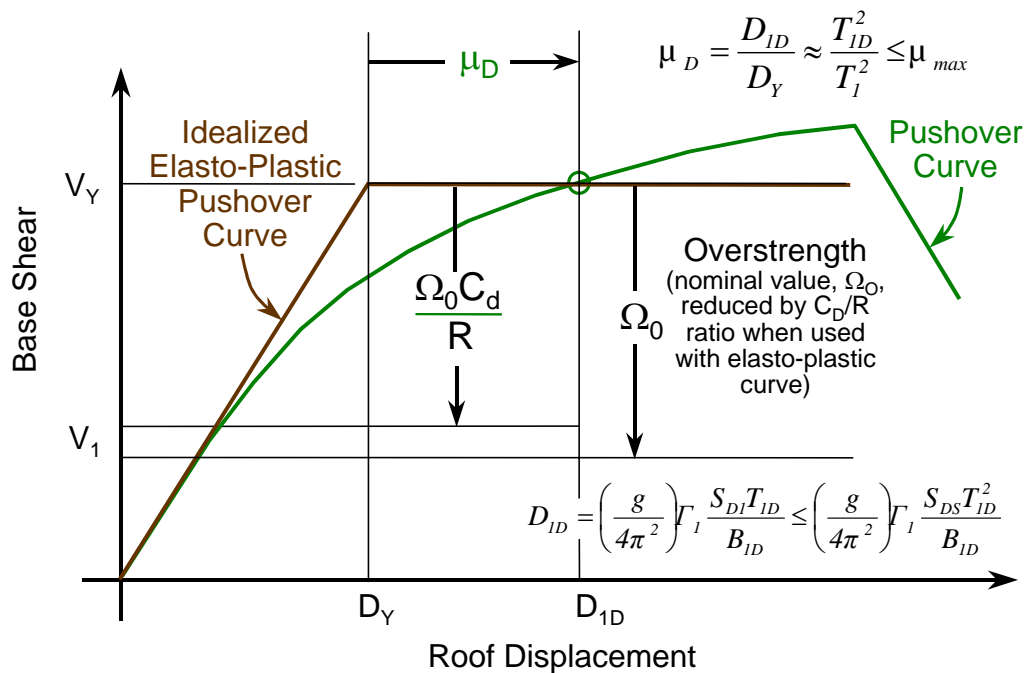

Figure C15-4. Idealized elasto-plastic pushover curve used for linear analysis.

The chapter requires elements of the *damping system* to be designed for actual fundamental-mode design earthquake forces corresponding to a base shear value of V_Y (except that damping devices are designed and prototypes tested for maximum considered earthquake response). Elements of the seismic-force-resisting system are designed for reduced fundamental-mode base shear, V_1 , where force reduction is based on system overstrength, Ω_0 , conservatively decreased by the ratio, C_d/R , for elastic analysis (when actual pushover strength is not known).

Nonlinear analysis methods. The chapter specifies procedures for the nonlinear response history analyses and a nonlinear static procedure. For designs in which the seismic-force-resisting-system will remain elastic, only the nonlinear damping device characteristics need to be modeled for these analyses.

REFERENCES

- Constantinou, M.C., T.T. Soong and G.F. Dargush. 1998. *Passive Energy Dissipation Systems for Structural Design and Retrofit*, Monograph No. 1, Multidisciplinary Center for Earthquake Engineering Research, University of Buffalo, State University of New York, Buffalo, NY.
- Hanson, Robert D. and Tsu T. Soong. 2001. *Seismic Design with Supplemental Energy Dissipation Devices*, MNO-8, Earthquake Engineering Research Institute, Oakland, CA.
- Ramirez, O.M., M.C. Constantinou, C.A. Kircher, A. Whittaker, M. Johnson, J.D. Gomez and C.Z. Chrysostomou. 2001. *Development and Evaluation of Simplified Procedures of Analysis and Design for Structures with Passive Energy Dissipation Systems*, Technical Report MCEER-00-0010, Revision 1, Multidisciplinary Center for Earthquake Engineering Research, University of Buffalo, State University of New York, Buffalo, NY.

Ramirez, O.M., Constantinou, M.C., Gomez, J., Whittaker, A.S., and Chrysostomou, C.Z. 2002a. *Evaluation of Simplified Methods of Analysis of Yielding Structures With Damping Systems*, Earthquake Spectra, Vol. 18, No. 3, Aug., pp. 501-530.

Ramirez, O.M., Constantinou, M.C., Whittaker, A.S., Kircher, C.A., and Chrysostomou, C.Z. 2002b. *Elastic And Inelastic Seismic Response of Buildings With Damping Systems*, Earthquake Spectra, Vol. 18, No. 3, Aug., pp. 531-547.

Ramirez, O.M., Constantinou, M.C., Whittaker, A.S., Kircher, C.A., Johnson, M.W. and Chrysostomou, C.Z. 2003. *Validation Of 2000 NEHRP Provisions Equivalent Lateral Force and Modal Analysis Procedures For Buildings With Damping Systems*, Earthquake Spectra, Vol. 19, No. 4, November, pp. 981-999.

Whittaker, A.S., Constantinou, M.C., Ramirez, O.M., Johnson, M.W. and Chrysostomou, C.Z. 2003. *Equivalent Lateral Force and Modal Analysis Procedures of the 2000 NEHRP Provisions For Buildings with Damping Systems*, Earthquake Spectra, Vol. 19, No. 4, November, pp. 959-980.

This page is intentionally left blank.

Commentary Appendix A

DEVELOPMENT OF MAXIMUM CONSIDERED EARTHQUAKE GROUND MOTION MAPS FIGURES 3.3-1 THROUGH 3.3-14

BACKGROUND

The maps used in the *Provisions* through 1994 provided the A_a (effective peak acceleration coefficient) and A_v (effective peak velocity-related acceleration coefficient) values to use for design. The BSSC had always recognized that the maps and coefficients would change with time as the profession gained more knowledge about earthquakes and their resulting ground motions and as society gained greater insight into the process of establishing acceptable risk.

By 1997, significant additional earthquake data had been obtained that made the A_a and A_v maps, then about 20 years old, seriously out of date. For the 1997 *Provisions*, a joint effort involving the BSSC, the Federal Emergency Management Agency (FEMA), and the U.S. Geological Survey (USGS) was conducted to develop both new maps for use in design and new design procedures reflecting the significant advances made in the past 20 years. The BSSC's role in this joint effort was to develop new ground motion maps for use in design and design procedures based on new USGS seismic hazard maps.

The BSSC appointed a 15-member Seismic Design Procedure Group (SDPG) to develop the seismic ground motion maps and design procedures. The SDPG membership was composed of representatives of different segments of the design community as well as two earth science members designated by the USGS, and the membership was representative of the different geographical regions of the country. Also, the BSSC, with input from FEMA and USGS, appointed a five-member Management Committee (MC) to guide the efforts of the SDPG. The MC was geographically balanced insofar as practicable and was composed of two seismic hazard definition experts and three engineering design experts, including the chairman of the 1997 *Provisions* Update Committee (PUC). The SDPG and the MC worked closely with the USGS to define the BSSC mapping needs and to understand how the USGS seismic hazard maps should be used to develop the BSSC seismic ground motion maps and design procedures.

For a brief overview of how the USGS developed its hazard maps, see Appendix B to this *Commentary* volume. A detailed description of the development of the maps is contained in the USGS Open-File Report 96-532, *National Seismic-Hazard Maps: Documentation, June 1996*, by Frankel, et al. (1996). The USGS hazard maps also can be viewed and printed from a USGS Internet site at <http://eqhazmaps.usgs.gov>.

The goals of the SDPG were as follows:

1. To replace the existing effective peak acceleration and velocity-related acceleration design maps with new ground motion spectral response maps based on new USGS seismic hazard maps.
2. To develop the new ground motion spectral response maps within the existing framework of the *Provisions* with emphasis on uniform margin against the collapse of structures.
3. To develop design procedures for use with the new ground motion spectral response maps.

PURPOSE OF THE PROVISIONS

The purpose of the *Provisions* is to present criteria for the design and construction of new structures subject to earthquake ground motions in order to minimize the risk to life for all structures, to increase

the expected performance of higher occupancy structures as compared to ordinary structures, and to improve the capability of essential structures to function after an earthquake. To this end, the *Provisions* provide the minimum criteria considered prudent for structures subjected to earthquakes at any location in the United States and its territories. The *Provisions* generally considers property damage as it relates to occupant safety for ordinary structures. For high occupancy and essential structures, damage limitation criteria are more strict in order to better provide for the safety of occupants and the continued functioning of the structure. Some structural and nonstructural damage can be expected as a result of the “design ground motions” because the *Provisions* allow inelastic energy dissipation by utilizing the deformability of the structural system. For ground motions in excess of the design levels, the intent is that there be a low likelihood of collapse. These goals of the *Provisions* were the guiding principles for developing the design maps.

POLICY DECISIONS FOR SEISMIC GROUND MOTION MAPS

The new maps (cited in both the 1997 and 2000 *Provisions*) reflect the following policy decisions that depart from past practice and the 1994 *Provisions*:

1. The maps define the maximum considered earthquake ground motion for use in design procedures,
2. The use of the maps for design provide an approximately uniform margin against collapse for ground motions in excess of the design levels in all areas.
3. The maps are based on both probabilistic and deterministic seismic hazard maps, and
4. The maps are response spectra ordinate maps and reflect the differences in the short-period range of the response spectra for the areas of the United States and its territories with different ground motion attenuation characteristics and different recurrence times.

These policy decisions reflected new information from both the seismic hazard and seismic engineering communities that is discussed below.

In the 1994 *Provisions*, the design ground motions were based on an estimated 90 percent probability of not being exceeded in 50 years (about a 500 year mean recurrence interval) (ATC 3-06 1978). The 1994 *Provisions* also recognized that larger ground motions are possible and that the larger motions, although their probability of occurrence during a structure’s life is very small, nevertheless can occur at any time. The 1994 *Provisions* also defined a maximum capable earthquake as “the maximum level of earthquake ground shaking that may ever be expected at the building site within the known geologic framework.” It was additionally specified that in certain map areas ($\geq A_a = 0.3$), the maximum capable earthquake was associated with a motion that has a 90 percent probability of not being exceeded in 100 years (about a 1000 year mean recurrence interval). In addition to the maximum capable earthquake definition, sample ground motion maps were prepared with 90 percent probabilities of not being exceeded in 250 years (about a 2500 year mean recurrence interval).

Given the wide range in return periods for maximum magnitude earthquakes throughout the United States and its territories (100 years in parts of California to 100,000 years or more in several other locations), current efforts have focused on defining the maximum considered earthquake ground motions for use in design (not the same as the maximum capable earthquake defined in the 1994 *Provisions*). The maximum considered earthquake ground motions are determined in a somewhat different manner depending on the seismicity of an individual region; however, they are uniformly defined as the maximum level of earthquake ground shaking that is considered as reasonable to design structures to resist. Focusing on ground motion versus earthquake size facilitates the development of a design approach that provides an approximately uniform margin against collapse throughout the United States.

As noted above, the 1994 *Provisions* generally used the notation of 90 percent probability of not being exceeded in a certain exposure time period (50, 100, or 250 years), which can then be used to calculate

a given mean recurrence interval (500, 1000, or 2500 years). For the purpose of the new maps and design procedure introduced in the 1997 *Provisions*, the single exposure time period of 50 years has been commonly used as a reference period over which to consider loads on structures (after 50 years of use, structures may require evaluation to determine future use and rehabilitation needs). With this in mind, different levels of probability or return period are expressed as percent probability of exceedance in 50 years. Specifically, 10 percent probability of exceedance in 50 years is a mean recurrence interval of about 500 years, 5 percent probability of exceedance in 50 years is a mean recurrence interval of about 1000 years, and 2 percent probability of exceedance in 50 years is a mean recurrence interval of about 2500 years. The above notation is used throughout the *Provisions*.

Review of modern probabilistic seismic hazard results, including the maps prepared by the USGS to support the effort resulting in the 1997 *Provisions*, indicates that the rate of change of ground motion versus probability is not constant throughout the United States. For example, the ground motion difference between the 10 percent probability of exceedance and 2 percent probability of exceedance in 50 years in coastal California is typically smaller than the difference between the two probabilities in less active seismic areas such as the eastern or central United States. Because of these differences, questions were raised concerning whether definition of the ground motion based on a constant probability for the entire United States would result in similar levels of seismic safety for all structures. Figure A1 plots the 0.2 second spectral acceleration normalized at 2 percent probability of exceedance in 50 years versus the annual frequency of exceedance. Figure A1 shows that in coastal California, the ratio between the 0.2 second spectral acceleration for the 2 and the 10 percent probabilities of exceedance in 50 years is about 1.5 whereas, in other parts of the United States, the ratio varies from 2.0 to 5.0.

FIGURE A1 Relative hazard at selected sites for 0.2 sec spectral response acceleration. The hazard curves are normalized at 2 percent probability of exceedance in 50 years.

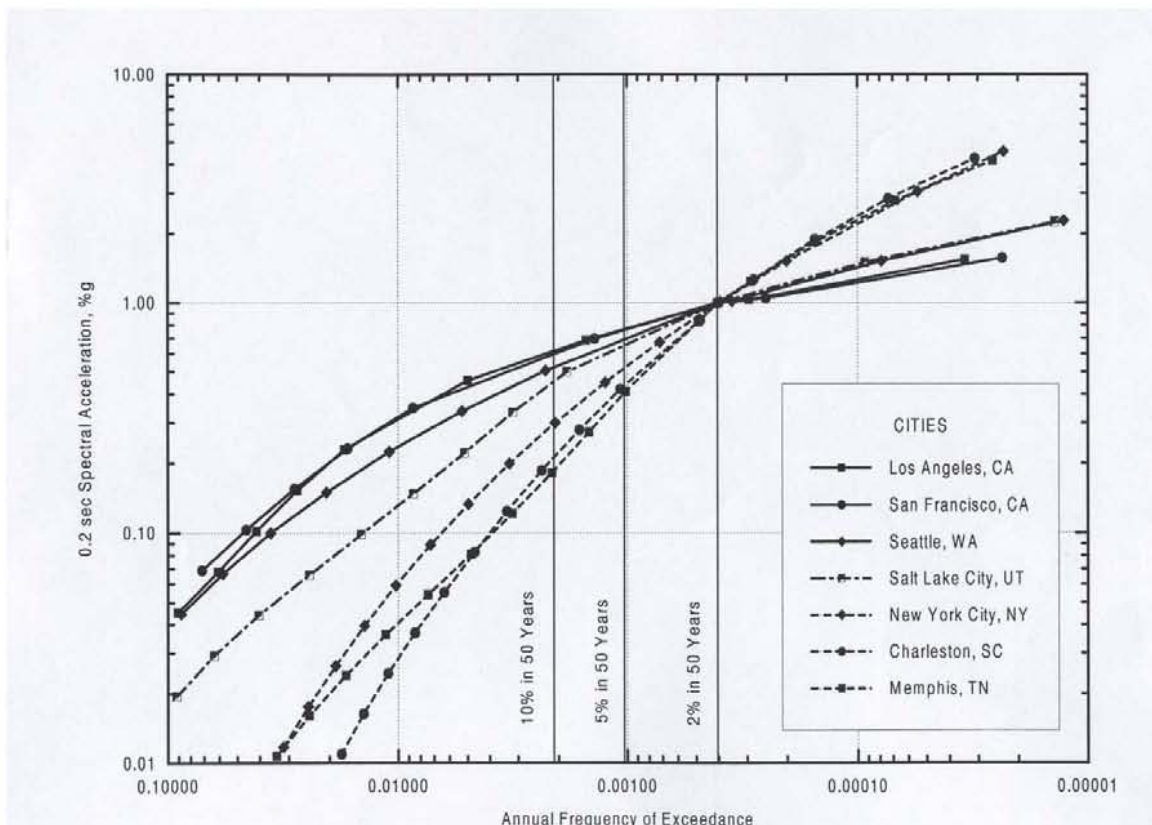

In answering the questions, it was recognized that seismic safety is the result of a number of steps in addition to defining the design earthquake ground motions, including the critical items generally defined as proper site selection, structural design criteria, analysis and procedures, detailed design requirements, and construction. The conservatism in the actual design of the structure is often referred to as the “seismic margin.” It is the seismic margin that provides confidence that significant loss of life will not be caused by actual ground motions equal to the design levels. Alternatively, the seismic margin provides a level of protection against larger, less probable earthquakes although at a lower level of confidence.

The collective opinion of the SDPG was that the seismic margin contained in the *Provisions* provides, as a minimum, a margin of about 1.5 times the design earthquake ground motions. In other words, if a structure experiences a level of ground motion 1.5 times the design level, the structure should have a low likelihood of collapse. The SDPG recognizes that quantification of this margin is dependent on the type of structure, detailing requirements, etc., but the 1.5 factor is a conservative judgment appropriate for structures designed in accordance with the *Provisions*. This seismic margin estimate is supported by Kennedy et al. (1994), Cornell (1994), and Ellingwood (1994) who evaluated structural design margins and reached similar conclusions.

The USGS seismic hazard maps indicate that in most locations in the United States the 2 percent probability of exceedance in 50 years ground motion values are more than 1.5 times the 10 percent probability of exceedance in 50 years ground motion values. This means that if the 10 percent probability of exceedance in 50 years map was used as the design map and the 2 percent probability of exceedance in 50 years ground motions were to occur, there would be low confidence (particularly in the central and eastern United States) that structures would not collapse due to these larger ground motions. Such a conclusion for most of the United States was not acceptable to the SDPG. The only location where the above results seemed to be acceptable was coastal California (2 percent probability of exceedance in 50 years map is about 1.5 times the 10 percent probability of exceedance in 50 years map) where structures have experienced levels of ground shaking equal to and above the design value.

The USGS probabilistic seismic hazard maps for coastal California also indicate the 10 percent probability of exceedance in 50 years seismic hazard map is significantly different from (in most cases larger) the design ground motion values contained in the 1994 *Provisions*. Given the generally successful experience with structures that complied with the recent editions of the *Uniform Building Code* whose design map contained many similarities to the 1994 *Provisions* design map, the SDPG was reluctant to suggest large changes without first understanding the basis for the changes. This stimulated a detailed review of the probabilistic maps for coastal California. This review identified a unique issue for coastal California in that the recurrence interval of the estimated maximum magnitude earthquake is less than the recurrence interval represented on the probabilistic map, in this case the 10 percent probability of exceedance in 50 years map (i.e., recurrence interval for maximum magnitude earthquake is 100 to 200 years versus 500 years.)

Given the above, one choice was to accept the change and use the 10 percent probability of exceedance in 50 years probabilistic map to define the design ground motion for coastal California and, using this, determine the appropriate probability for design ground motion for the rest of the United States that would result in the same level of seismic safety. This would have resulted in the design earthquake being defined at 2 percent probability of exceedance in 50 years and the need for development of a 0.5 to 1.0 percent probability of exceedance in 50 years map to show the potential for larger ground motions outside of coastal California. Two major problems were identified. The first is that requiring such a radical change in design ground motion in coastal California seems to contradict the general conclusion that the seismic design codes and process are providing an adequate level of life safety. The second is that completing probabilistic estimates of ground motion for lower probabilities (approaching those used for critical facilities such as nuclear power plants) is associated with large uncertainties and can be quite controversial.

An alternative choice was to build on the observation that the maximum earthquake for many seismic faults in coastal California is fairly well known and associated with probabilities larger than a 10 percent probability of exceedance in 50 years (500 year mean recurrence interval). Given this, a decision was made to develop a procedure that would use the best estimate of ground motion from maximum magnitude earthquakes on seismic faults with high probabilities of occurrence (short return periods). For the purposes of the *Provisions*, these earthquakes are defined as “deterministic earthquakes.” Following this approach and recognizing the inherent seismic margin contained in the *Provisions*, it was determined that the level of seismic safety achieved in coastal California would be approximately equivalent to that associated with a 2 to 5 percent probability of exceedance in 50 years for areas outside of coastal California. In other words, the use of the deterministic earthquakes to establish the maximum considered earthquake ground motions for use in design in coastal California results in a level of protection close to that implied in the 1994 *Provisions* and consistent with maximum magnitude earthquakes expected for those seismic sources. Additionally, this approach results in less drastic changes to ground motion values for coastal California than the alternative approach of using probabilistic based maps.

One could ask why any changes are necessary for coastal California given the positive experience from recent earthquakes. While it is true that the current seismic design practices have produced positive results, the current design ground motions in the 1994 *Provisions* are less than those expected from maximum magnitude earthquakes on known seismic sources. The 1994 *Provisions* reportedly considered maximum magnitude earthquakes but did not directly link them to the design ground motions (Applied Technology Council, 1978). If there is high confidence in the definition of the fault and magnitude of the earthquake and the maximum earthquake occurs frequently, then the design should be linked to at least the best estimate ground motion for such an earthquake. Indeed, it is the actual earthquake experience in coastal California that is providing increased confidence in the seismic margins contained in the *Provisions*.

The above approach also is responsive to comments that the use of 10 percent probability of exceedance in 50 years is not sufficiently conservative in the central and eastern United States where the earthquakes are expected to occur infrequently. Based on the above discussion and the inherent seismic margin contained in the *Provisions*, the SDPG selected 2 percent probability of exceedance in 50 years as the maximum considered earthquake ground motion for use in design where the use of the deterministic earthquake approach discussed above is not used.

The maximum considered earthquake ground motion maps are based on two response spectral values (a short-period and a long-period value) instead of the A_a and A_v coefficients. The decision to use response spectral values is based on earthquake data obtained during the past 20 years showing that site-specific spectral values are more appropriate for design input than the A_a and A_v coefficients used with standardized spectral shapes. The spectral shapes vary in different areas of the country and for different site conditions. This is particularly the case for the short-period portion of the response spectra. Based on the differences in the ground motion attenuation characteristics between the central and eastern and western United States, the USGS used different ground motion attenuation functions for these areas in developing the seismic hazard maps. The ground motion attenuation functions in the eastern United States result in higher short-period spectral accelerations at lower periods for a given earthquake magnitude than the western United States attenuation functions, particularly compared to the high seismicity region of coastal California. The short-period response spectral values were reviewed in order to determine the most appropriate value to use for the maximum considered earthquake ground motion maps. Based on this review, the short-period spectral response value of 0.2 second was selected to represent the short-period range of the response spectra for the eastern United States. In the western United States the most appropriate short-period response spectral value was determined to be 0.3 second, but a comparison of the 0.2 and 0.3 second values indicated that the differences in the response spectral values were insignificant. Based on this and for convenience of preparing the maximum considered earthquake ground motion maps, the short-period response spectral value of 0.2 second was selected to represent the short-period range of the response spectra

for all of the United States. The long-period response spectral value selected for use is 1.0 second for all of the United States. Based on the ground motion attenuation functions and the USGS seismic hazard maps, a $1/T$ (T = natural period) relationship was selected to define the response spectra from the short period value to the long-period value. Using the spectral values from the ground motion maps will allow the different spectral shapes to be incorporated into design.

DEVELOPMENT OF THE MAXIMUM CONSIDERED EARTHQUAKE GROUND MOTION MAPS FOR USE IN DESIGN

The concept for developing maximum considered earthquake ground motions for use in design involved two distinct steps:

1. The various USGS probabilistic seismic hazard maps were combined with deterministic hazard maps by a set of rules (logic) to create the maximum considered earthquake ground motion maps that can be used to define response spectra for use in design and
2. Design procedures were developed that transform the response spectra into design values (e.g., design base shear).

The response spectra defined from the first step represent general “site-dependent” spectra similar to those that would be obtained by a geotechnical study and used for dynamic analysis except their shapes are less refined (i.e., shape defined for only a limited number of response periods). The response spectra do not represent the same hazard level across the country but do represent actual ground motion consistent with providing approximately uniform protection against the collapse of structures. The response spectra represent the maximum considered earthquake ground motions for use in design for Site Class B (rock with a shear wave velocity of 760 meters/second).

The maximum considered earthquake ground motion maps for use in design are based on a defined set of rules for combining the USGS seismic hazard maps to reflect the differences in the ability to define the fault sources and seismicity characteristics across the regions of the country as discussed in the policy decisions. Accommodating regional differences allows the maximum considered earthquake maps to represent ground motions for use in design that provide reasonably consistent margins of preventing the collapse of structures. Based on this, three regions have been defined:

1. Regions of negligible seismicity with very low probability of collapse of the structure,
2. Regions of low and moderate to high seismicity, and
3. Regions of high seismicity near known fault sources with short return periods.

Regions of Negligible Seismicity With Very Low Probability of Collapse of the Structure

The regions of negligible seismicity with very low probability of collapse have been defined by:

1. Determining areas where the seismic hazard is controlled by earthquakes with M_b (body wave magnitude) magnitudes less than or equal to 5.5 and
2. Examining the recorded ground motions associated with Modified Mercalli Intensity V.

The basis for the first premise is that in this region, there are a number of examples of earthquakes with $M_b \approx 5.5$ which caused only localized damage to structures not designed for earthquakes. The basis for the second premise is that Modified Mercalli Intensity V ground motions typically do not cause structural damage. By definition, Modified Mercalli Intensity V ground shaking is felt by most people, displaces or upsets small objects, etc., but typically causes no, or only minor, structural damage in buildings of any type. Modified Mercalli Intensity VI ground shaking is felt by everyone, small objects fall off shelves, etc., and minor or moderate structural damage occurs to weak plaster and masonry construction. Life-threatening damage or collapse of *structures* would not be expected for either Modified Mercalli Intensities V or VI ground shaking. Based on an evaluation of 1994 Northridge earthquake data, regions of different Modified Mercalli Intensity (Dewey, 1995) were correlated with maps of smooth response spectra developed from instrumental recordings

(Sommerville, 1995). The Northridge earthquake provided a sufficient number of instrumental recordings and associated spectra to permit correlating Modified Mercalli Intensity with response spectra. The results of the correlation determined the average response spectrum for each Modified Mercalli Intensity region. For Modified Mercalli Intensity V, the average response spectrum of that region had a spectral response acceleration of slightly greater than 0.25g at 0.3 seconds and a spectral response acceleration of slightly greater than 0.10g at 1.0 seconds. On the basis of these values and the minor nature of damage associated with Modified Mercalli Intensity V, 0.25g (short-period acceleration) and 0.10g (acceleration at a period of 1 second, taken proportional to $1/T$) is deemed to be a conservative estimate of the spectrum below which life-threatening damage would not be expected to occur even to the most vulnerable of types of structures. Therefore, this region is defined as areas having maximum considered earthquake ground motions with a 2 percent probability of exceedance in 50 years equal to or less than 0.25g (short period) and 0.10g (long period). The seismic hazard in these areas is generally the result of $M_b \approx 5.5$ earthquakes. In these areas, a minimum lateral force design of 1 percent of the dead load of the structure shall be used in addition to the detailing requirements for the Seismic Design Category A structures.

In these areas it is not considered necessary to specify seismic-resistant design on the basis of a maximum considered earthquake ground motion. The ground motion computed for such areas is determined more by the rarity of the event with respect to the chosen level of probability than by the level of motion that would occur if a small but close earthquake actually did occur. However, it is desirable to provide some protection, both against earthquakes as well as many other types of unanticipated loadings. The requirements for Seismic Design Category A provide a nominal amount of structural integrity that will improve the performance of buildings in the event of a possible, but rare earthquake. The result of design to Seismic Design Category A is that fewer buildings would collapse in the vicinity of such an earthquake.

The integrity is provided by a combination of requirements. First, a complete load path for lateral forces must be identified. Then it must be designed for a lateral force equal to a 1% acceleration on the mass. Lastly, the minimum connection forces specified for Seismic Design Category A must be satisfied.

The 1 percent value has been used in other countries as a minimum value for structural integrity. For many structures, design for the wind loadings specified in the local building codes will normally control the lateral force design when compared to the minimum structural integrity force on the structure. However, many low-rise heavy structures or structures with significant dead loads resulting from heavy equipment may be controlled by the nominal 1 percent acceleration. Also, minimum connection forces may exceed structural forces due to wind in additional structures.

The regions of negligible seismicity will vary depending on the Site Class on which structures are located. The *Provisions* seismic ground motion maps (Maps 1 through 19) are for Site Class B conditions and the region of negligible seismicity for Site Class B is defined where the maximum considered earthquake ground motion short-period values are $\leq 0.25g$ and the long-period values are $\leq 0.10g$. The regions of negligible seismicity for the other Site Classes are defined by using the appropriate site coefficients to determine the maximum considered earthquake ground motion for the Site Class and then determining if the short-period values are $\leq 0.25g$ and the long-period values are $\leq 0.10g$. If so, then the site of the structure is located in the region of negligible seismicity for that Site Class.

Regions of Low and Moderate to High Seismicity

In regions of low and moderate to high seismicity, the earthquake sources generally are not well defined and the maximum magnitude estimates have relatively long return periods. Based on this, probabilistic hazard maps are considered to be the best means to represent the uncertainties and to define the response spectra for these regions. The maximum considered earthquake ground motion for

these regions is defined as the ground motion with a 2 percent probability of exceedance in 50 years. The basis for this decision is explained in the policy discussion.

Consideration was given to establishing a separate region of low seismicity and defining a minimum level of ground motion (i.e., deterministic minimum ground motions). This was considered because in the transition between the regions of negligible seismicity to the regions of low seismicity, the ground motions are relatively small and may not be very meaningful for use in seismic design. The minimum level was also considered because the uncertainty in the ground motion levels in the regions of low seismicity is larger than in the regions of moderate to high seismicity. This larger uncertainty may warrant consideration of using higher ground motions (or some minimum level of ground motion) than provided by the maximum considered earthquake ground motions shown on the maps.

The studies discussed above for the regions of negligible seismicity by Dewey (1995) and Sommerville (1995), plus other unpublished studies (to date), were evaluated as a means of determining minimum levels of ground motion for used in design. These studies correlated the Modified Mercalli Intensity data with the recorded ground motions and associated damage. The studies included damage information for a variety of structures which had no specific seismic design and determined the levels of ground motion associated with each Modified Mercalli Intensity. These studies indicate that ground motion levels of about 0.50g short-period spectral response and 0.20g long-period spectral response are representative of Modified Mercalli Intensity VII damage.

Modified Mercalli Intensity VII ground shaking results in negligible damage in buildings of good design and construction, slight to moderate damage in well-built ordinary buildings, considerable damage in poorly-built or badly designed buildings, adobe houses, old walls (especially where laid up without mortar), etc. In other words, Modified Mercalli VII ground shaking is about the level of ground motion where significant structural damage may occur and result in life safety concerns for occupants. This tends to suggest that designing structures for ground motion levels below 0.50g short-period spectral response and 0.20g long-period spectral response may not be meaningful.

One interpretation of this information suggests that the ground motion levels for defining the regions of negligible seismicity could be increased. This interpretation would result in much larger regions that require no specific seismic design compared to the 1994 *Provisions*.

Another interpretation of the information suggests establishing a minimum level of ground Motion (at about the Modified Mercalli VII shaking) for regions of low seismicity, in order to transition from the regions of negligible seismicity to the region of moderate to high seismicity. Implementation of a minimum level of ground motion, such as 0.50g for the short-period spectral response and 0.20g for the long-period spectral response, would result in increases (large percentages) in ground motions used for design compared to the 1994 *Provisions*.

Based on the significant changes in past practices resulting from implementing either of the above interpretations, the SDPG decided that additional studies are needed to support these changes. Results of such studies should be considered for future editions of the *Provisions*.

Regions of High Seismicity Near Known Fault Sources With Short Return Periods

In regions of high seismicity near known fault sources with short return periods, deterministic hazard maps are used to define the response spectra maps as discussed above. The maximum considered earthquake ground motions for use in design are determined from the USGS deterministic hazard maps developed using the ground motion attenuation functions based on the median estimate increased by 50 percent. Increasing the median ground motion estimates by 50 percent is deemed to provide an appropriate margin and is similar to some deterministic estimates for a large magnitude characteristic earthquake using ground motion attenuation functions with one standard deviation. Estimated standard deviations for some active fault sources have been determined to be higher than 50 percent, but this increase in the median ground motions was considered reasonable for defining the maximum considered earthquake ground motions for use in design.

Maximum Considered Earthquake Ground Motion Maps for Use in Design

Considering the rules for the three regions discussed above, the maximum considered earthquake ground motion maps for use in design were developed by combining the regions in the following manner:

1. Where the maximum considered earthquake map ground motion values (based on the 2 percent probability of exceedance in 50 years) for Site Class B adjusted for the specific site conditions are $\leq 0.25g$ for the short-period spectral response and $\leq 0.10g$ for the long period spectral response, then the site will be in the region of negligible seismicity and a minimum lateral force design of 1 percent of the dead load of the structure shall be used in addition to the detailing requirements for the Seismic Design Category A structures.
2. Where the maximum considered earthquake ground motion values (based on the 2 percent probability of exceedance in 50 years) for Site Class B adjusted for the specific site conditions are greater than $0.25g$ for the short-period spectral response and $0.10g$ for the long-period spectral response, the maximum considered earthquake ground motion values (based on the 2 percent probability of exceedance in 50 years adjusted for the specific site conditions) will be used until the values equal the present (1994 *Provisions*) ceiling design values increased by 50 percent (short period = $1.50g$, long period = $0.60g$). The present ceiling design values are increased by 50 percent to represent the maximum considered earthquake ground motion values. This will define the sites in regions of low and moderate to high seismicity.
3. To transition from regions of low and moderate to high seismicity to regions of high seismicity with short return periods, the maximum considered earthquake ground motion values based on 2 percent probability of exceedance in 50 years will be used until the values equal the present (1994 *Provisions*) ceiling design values increased by 50 percent (short period = $1.50g$, long period = $0.60g$). The present ceiling design values are increased by 50 percent to represent maximum considered earthquake ground motion values. When the 1.5 times the ceiling values are reached, then they will be used until the deterministic maximum considered earthquake map values of $1.5g$ (long period) and $0.60g$ (short period) are obtained. From there, the deterministic maximum considered earthquake ground motion map values will be used.

In some cases there are regions of high seismicity near known faults with return periods such that the probabilistic map values (2 percent probability of exceedance in 50 years) will exceed the present ceiling values of the 1994 *Provisions* increased by 50 percent and will be less than the deterministic map values. In these regions, the probabilistic map values will be used for the maximum considered earthquake ground motions.

The basis for using present ceiling design values as the transition between the two regions is because earthquake experience has shown that regularly configured, properly designed *structures* performed satisfactorily in past earthquakes. The most significant structural damage experienced in the Northridge and Kobe earthquakes was related to configuration, structural systems, inadequate connection detailing, incompatibility of deformations, and design or construction deficiencies -- not due to deficiency in strength (Structural Engineers Association of California, 1995). The earthquake designs of the structures in the United States (coastal California) which have performed satisfactorily in past earthquakes were based on the criteria in the *Uniform Building Code*. Considering the site conditions of the structures and the criteria in the *Uniform Building Code*, the ceiling design values for these structures were determined to be appropriate for use with the *Provisions* maximum considered earthquake ground motion maps for Site Class B. Based on this, the equivalent maximum considered earthquake ground motion values for the ceiling were determined to be $1.50g$ for the short period and $0.60g$ for the long period.

As indicated above there also are some regions of high seismicity near known fault sources with return periods such that the probabilistic map values (2 percent probability of exceedance in 50 years) will exceed the ceiling values of the 1994 *Provisions* increased by 50 percent and also be less than the

deterministic map values. In these regions, the probabilistic map values are used for the maximum considered earthquake ground motions.

The near source area in the high seismicity regions is defined as the area where the maximum considered earthquake ground motion values are $\geq 0.75g$ on the 1.0 second map. In the near source area, *Provisions* Sec. 5.2.3 through 5.2.6 impose additional requirements for certain structures unless the structures are fairly regular, do not exceed 5 stories in height, and do not have a period of vibration over 0.5 seconds. For the fairly regular structures not exceeding 5 stories in height and not having a period of vibration over 0.5 seconds, the maximum considered earthquake ground motion values will not exceed the present ceiling design values increased by 50 percent. The basis for this is because of the earthquake experience discussed above.

These development rules for the maximum considered earthquake ground motion maps for use in design are illustrated in Figures A2 and A3. The application of these rules resulted in the maximum considered earthquake ground motion maps (Maps 1 through 24) introduced in the 1997 and used again in the 2000 *Provisions*.

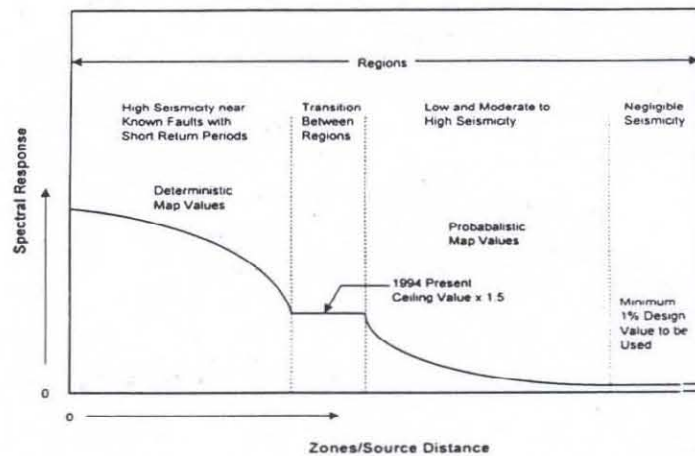

FIGURE A2 Development of the maximum considered earthquake ground motion map for spectral acceleration of $T = 1.0$, Site Class B.

STEP 1 -- DEFINE POTENTIAL SEISMIC SOURCES

- A. *Compile Earth Science Information*** -- Compile historic seismicity and fault characteristics including earthquake magnitudes and recurrence intervals.
- B. *Prepare Seismic Source Map*** -- Specify historic seismicity and faults used as sources.

STEP 2 -- PREPARE PROBABILISTIC AND DETERMINISTIC SPECTRAL RESPONSE MAPS

A. *Develop Regional Attenuation Relations*

- (1) Eastern U.S. (Toro, et al., 1993, and Frankel, 1996)
- (2) Western U.S. (Boore et al., 1993 & 1994, Campbell and Bozorgnia, 1994, and Sadigh, 1993 for PGA. Boore et al., 1993 & 1994, and Sadigh, 1993 for spectral values)
- (3) Deep Events (>35km) (Geomatrix et al., 1993)
- (4) Cascadia Subduction Zone (Geomatrix et al., 1993, and Sadigh, 1993)

B. *Prepare Probabilistic Spectral Response Maps (USGS Probabilistic Maps)* -- Maps showing S_S and S_I where S_S and S_I are the short and 1 second period ground motion response spectral values for a 2 percent chance of exceedence in 50 years inferred for sites with average shear wave velocity of 760 m/s from the information developed in Steps 1A and 1B and the ground motion attenuation relationships in Step 2A.

C. *Prepare Deterministic Spectral Response Maps (USGS Deterministic Maps)* -- Maps showing S_S and S_I for faults and maximum earthquakes developed in Steps 1A and 1B and the median ground motion attenuation relations in Step 2A increased by 50% to represent the uncertainty.

STEP 3 -- PREPARE EARTHQUAKE GROUND MOTION SPECTRAL RESPONSE MAPS FOR PROVISIONS (MAXIMUM CONSIDERED EARTHQUAKE GROUND MOTION MAP)

Region 1 -- Regions of Negligible Seismicity with Very Low Probability of Collapse of the Structure (No Spectral Values)

Region definition: Regions for which $S_S < 0.25g$ and $S_I < 0.10g$ from Step 2B.

Design values: No spectral ground motion values required. Use a minimum lateral force level of 1 percent of the dead load for Seismic Design Category A.

Region 2 -- Regions of Low and Moderate to High Seismicity (Probabilistic Map Values)

Region definition: Regions for which $0.25g < S_S < 1.5g$ and $0.25g < S_I < 0.60g$ from Step 2B.

Maximum considered earthquake map values: Use S_S and S_I map values from Step 2B.

Transition Between Regions 2 and 3 - Use MCE values of $S_S = 1.5g$ and $S_I = 0.60g$

Region 3 -- Regions of High Seismicity Near Known Faults (Deterministic Values)

Region definition: Regions for which $1.5g < S_S$ and $0.60g < S_I$ from Step 2C.

Maximum considered earthquake map values: Use S_S and S_I map values from Step 2C.

FIGURE A3 Methodology for development of the maximum considered earthquake ground motion maps (Site Class B).

Use of the Maximum Considered Earthquake Ground Motion Maps in the Design Procedure:

The 1994 *Provisions* defined the seismic base shear as a function of the outdated effective peak velocity-related acceleration A_v , and effective peak acceleration, A_a . Beginning with the 1997 *Provisions*, the base shear of the structure is defined as a function of the maximum considered earthquake ground motion maps where S_S = maximum considered earthquake spectral acceleration in the short-period range for Site Class B; S_I = maximum considered earthquake spectral acceleration at the 1.0 second period for Site Class B; S_{MS} = $F_a S_S$, maximum considered earthquake spectral acceleration in the short-period range adjusted for Site Class effects where F_a is the site coefficient defined in *Provisions* Sec. 4.1.2; S_{M1} = $F_v S_I$, maximum considered earthquake spectral acceleration at 1.0 second period adjusted for Site Class effects where F_v is the site coefficient defined in *Provisions* Sec. 4.1.2; S_{DS} = $(2/3) S_{MS}$, spectral acceleration in the short-period range for the design ground motions; and S_{D1} = $(2/3) S_{M1}$, spectral acceleration at 1.0 second period for the design ground motions.

As noted above, the design ground motions S_{DS} and S_{D1} are defined as $2/3$ times the *maximum considered earthquake* ground motions. The $2/3$ factor is based on the estimated seismic margins in the design process of the *Provisions* as previously discussed (i.e., the design level of ground motion is $1/1.5$ or $2/3$ times the maximum considered earthquake ground motion).

Based on the above defined ground motions, the base shear is:

$$V = C_s W$$

where $C_s = \frac{S_{DS}}{R/I}$ and S_{DS} = the design spectral response acceleration in the short period range as

determined from Sec. 4.1.2, R = the response modification factor from Table 5.2.2, and I = the occupancy importance factor determined in accordance with Sec. 1.4.

The value of C_s need not exceed $C_s = \frac{S_{D1}}{T(R/I)}$ but shall not be taken less than $C_s = 0.1 S_{D1}$ or, for

buildings and structures in Seismic Design Categories E and F, $C_s = \frac{0.5 S_1}{R/I}$

where I and R are as defined above and S_{D1} = the design spectral response acceleration at a period of 1.0 second as determined from Sec. 4.1.2, T = the fundamental period of the structure (sec) determined in Sec. 5.4.2, and S_1 = the mapped maximum considered earthquake spectral response acceleration determined in accordance with Sec. 4.1.

Where a design response spectrum is required by these *Provisions* and site-specific procedures are not used, the design response spectrum curve shall be developed as indicated in Figure A4 and as follows:

1. For periods less than or equal to T_0 , the design spectral response acceleration, S_a , shall be taken as given by Eq. 4.1.2.6-1:

$$S_a = 0.6 \frac{S_{DS}}{T_0} T + 0.4 S_{DS} \quad (4.1.2.6-1)$$

2. For periods greater than or equal to T_0 and less than or equal to T_S , the design spectral response
3. For periods greater than T_S , the design spectral response acceleration, S_a , shall be taken as given by Eq. 4.1.2.6-3.

$$S_a = \frac{S_{D1}}{T} \quad (4.1.2.6-3)$$

where:

S_{DS} = the design spectral response acceleration at short periods;

S_{D1} = the design spectral response acceleration at 1 second period;

T = the fundamental period of the *structure* (sec);

$T_0 = 0.2S_{D1}/S_{DS}$; and

$T_S = S_{D1}/S_{DS}$.

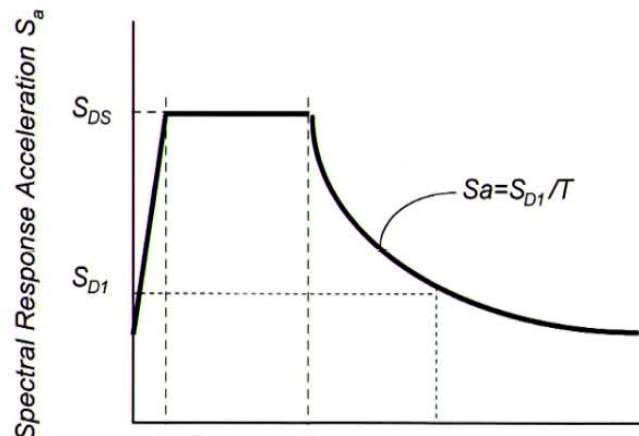

FIGURE A4 Design response spectrum.

Site-specific procedures for determining ground motions and response spectra are discussed in Sec. 4.1.3 of the *Provisions*.

REFERENCES

Applied Technology Council. 1978. *Tentative Provisions for the Development of Seismic Regulations for Building*, Report ATC-3-06. Redwood City, California: Applied Technology Council.

Structural Engineers Association of California. 1995. *Vision 2000, Performance Based Seismic Engineering of Buildings*. Prepared by the Structural Engineers Association of California, Vision 2000 Committee, for the California Office of Emergency Services.

Kennedy, R. P. and S. A. Short. 1994. *Basis for Seismic Provisions of DOE-STD-1020*, UCRL-CR-111478. Prepared for Lawrence Livermore National Laboratory. Livermore: University of California.

Ellingwood, B. R. 1994. "Probability-based Codified Design for Earthquakes." *Engineering Structures* 17(7).

Cornell, C. A. 1994. *Risk-Based Structural Design, Proceedings of Symposium on Risk Analysis*, Ann Arbor: University of Michigan.

Dewey, J. W., B. G. Reagor, L. Dengler, and K. Moley. 1995. *Intensity Distribution and Isoseismal Maps for the Northridge, California, Earthquake of January 17, 1994*, U. S. Geological Survey Open-File Report 95-92.

Sommerville, P. 1995. "Smooth Site Response Spectra Contours Developed for ATC-33," Appendix B of *Guidelines for Seismic Rehabilitation of Existing Buildings, Northridge Earthquake Case-Study Report*, ATC-33-1. Redwood City, California: Applied Technology Council.

Frankel, et al. 1996. *National Seismic-Hazard Maps: Documentation, June 1996*, U.S. Geological Survey Open-File Report 96-532.

Commentary Appendix B

DEVELOPMENT OF THE USGS SEISMIC MAPS

INTRODUCTION

The 1997 *Provisions* used new design procedures based on the use of spectral response acceleration rather than the traditional peak ground acceleration and/or peak ground velocity, and these procedures are used again in the 2000 *Provisions*. The use of spectral ordinates and their relationship to building codes has been described by Leyendecker et al. (1995). The spectral response accelerations used in the new design approach are obtained from combining probabilistic maps (Frankel et al, 1996) prepared by the U.S. Geological Survey (USGS) with deterministic maps using procedures developed by the Building Seismic Safety Council's Seismic Design Procedures Group (SDPG). The SDPG recommendations are based on using the 1996 USGS probabilistic hazard maps with additional modifications based on review by the SDPG and the application of engineering judgment. This appendix summarizes the development of the USGS maps and describes how the 1997 and 2000 *Provisions* design maps were prepared from them using SDPG recommendations. The SDPG effort has sometimes been referred to as Project '97.

DEVELOPMENT OF PROBABILISTIC MAPS FOR THE UNITED STATES

New seismic hazard maps for the conterminous United States were completed by the USGS in June 1996 and placed on the World Wide Web (<http://geohazards.cr.usgs.gov/eq/>). The color maps can be viewed on the Web and/or downloaded to the user's computer for printing. Paper copies of the maps are also available (Frankel et al, 1997a, 1997b).

New seismic hazard maps for Alaska were completed by the USGS in January 1998 and placed on the USGS Web site (<http://geohazards.cr.usgs.gov/eq/>). Both documentation and printing of the maps are in progress (U. S. Geological Survey, 1998a, 1998b).

New probabilistic maps are in preparation for Hawaii using the methodology similar to that used for the rest of the United States, and described below. These maps were to have been completed in early 1998. Probabilistic maps for Puerto Rico, Culebra, Vieques, St. Thomas, St. John, St. Croix, Guam, and Tutuila needed for the 1997 *Provisions* are not expected during the current cycle of USGS map revisions (development of design maps for these areas is described below).

This appendix provides a brief description of the USGS seismic hazard maps, the geologic/seismologic inputs to these maps, and the ground-motion relations used for the maps. It is based on the USGS map documentation for the central and eastern United States (CEUS) and the western United States (WUS) prepared by Frankel et al. (1996). The complete reference document, also available on the USGS Web site, should be reviewed for detailed technical information.

The hazard maps depict probabilistic ground acceleration and spectral response acceleration with 10 percent, 5 percent, and 2 percent probabilities of exceedance (PE) in 50 years. These maps correspond to return times of approximately 500, 1000, and 2500 years, respectively.¹ All spectral response values shown in the maps correspond to 5 percent of critical damping. The maps are based on the assumption that earthquake occurrence is Poissonian, so that the probability of occurrence is time-

¹ Previous USGS maps (e.g. Algermissen et al., 1990 and Leyendecker et al., 1995) and earlier editions of the *Provisions* expressed probability as a 10 percent probability of exceedance in a specified exposure time. Beginning with the 1996 maps, probability is being expressed as a specified probability of exceedance in a 50 year time period. Thus, 5 percent in 50 years and 2 percent in 50 years used now correspond closely to 10 percent in 100 years and 10 percent in 250 years, respectively, that was used previously. This same information may be conveyed as annual frequency. In this approach 10 percent probability of exceedance (PE) in 50 years corresponds to an annual frequency of exceedance of 0.0021; 5 percent PE in 100 years corresponds to 0.00103; and 2 percent PE in 50 years corresponds to 0.000404.

independent. The methodologies used for the maps were presented, discussed, and substantially modified during 6 regional workshops for the conterminous United States convened by the USGS from June 1994-June 1995. A seventh workshop for Alaska was held in September 1996.

The methodology for the maps (Frankel et al., 1996) includes three primary features:

1. The use of smoothed historical seismicity is one component of the hazard calculation. This is used in lieu of source zones used in previous USGS maps. The analytical procedure is described in Frankel (1995).
2. Another important feature is the use of alternative models of seismic hazard in a logic tree formalism. For the CEUS, different models based on different reference magnitudes are combined to form the hazard maps. In addition, large background zones based on broad geologic criteria are used as alternative source models for the CEUS and the WUS. These background zones are meant to quantify hazard in areas with little historic seismicity, but with the potential to produce major earthquakes. The background zones were developed from extensive discussions at the regional workshops.
3. For the WUS, a big advance in the new maps is the use of geologic slip rates to determine fault recurrence times. Slip rates from about 500 faults or fault segments were used in preparing the probabilistic maps.

The hazard maps do not consider the uncertainty in seismicity or fault parameters. Preferred values of maximum magnitudes and slip rates were used instead. The next stage of this effort is the quantification of uncertainties in hazard curves for selected sites. These data will be included on the Internet as they become available.

The USGS hazard maps are not meant to be used for Mexico, areas north of 49 degrees north latitude, and offshore the Atlantic and Gulf of Mexico coasts of the United States.

CEUS and WUS attenuation boundary. Attenuation of ground motion differs between the CEUS and the WUS. The boundary between regions was located along the eastern edge of the Basin and Range province (Figure B1). The previous USGS maps (e.g., Algermissen et al., 1990) used an attenuation boundary further to the east along the Rocky Mountain front.

Separate hazard calculations were done for the two regions using different attenuation relations. Earthquakes west of the boundary used the WUS attenuation relations and earthquakes east of the boundary used CEUS attenuation relations. WUS attenuation relations were used for WUS earthquakes, even for sites located east of the attenuation boundary. Similarly CEUS attenuations were used for CEUS earthquakes, even for sites located west of the attenuation boundary. It would have been computationally difficult to consider how much of the path was contained in the attenuation province. Also, since the attenuation relation is dependent on the stress drop, basing the relation that was used on the location of the earthquake rather than the receiver is reasonable.

Hazard curves. The probabilistic maps were constructed from mean hazard curves, that is the mean probabilities of exceedance as a function of ground motion or spectral response. Hazard curves were obtained for each site on a calculation grid.

A grid (or site) spacing of 0.1 degrees in latitude and longitude was used for the WUS and 0.2 degrees for the CEUS. This resulted in hazard calculations at about 65,000 sites for the WUS runs and 35,000 sites for the CEUS runs. The CEUS hazard curves were interpolated to yield a set of hazard curves on a 0.1 degree grid. A grid of hazard curves with 0.1 degree spacing was thereby obtained for the entire conterminous United States. A special grid spacing of 0.05 degrees was also done for California, Nevada, and western Utah because of the density of faults warranted increased density of data. These data were used for maps of this region.

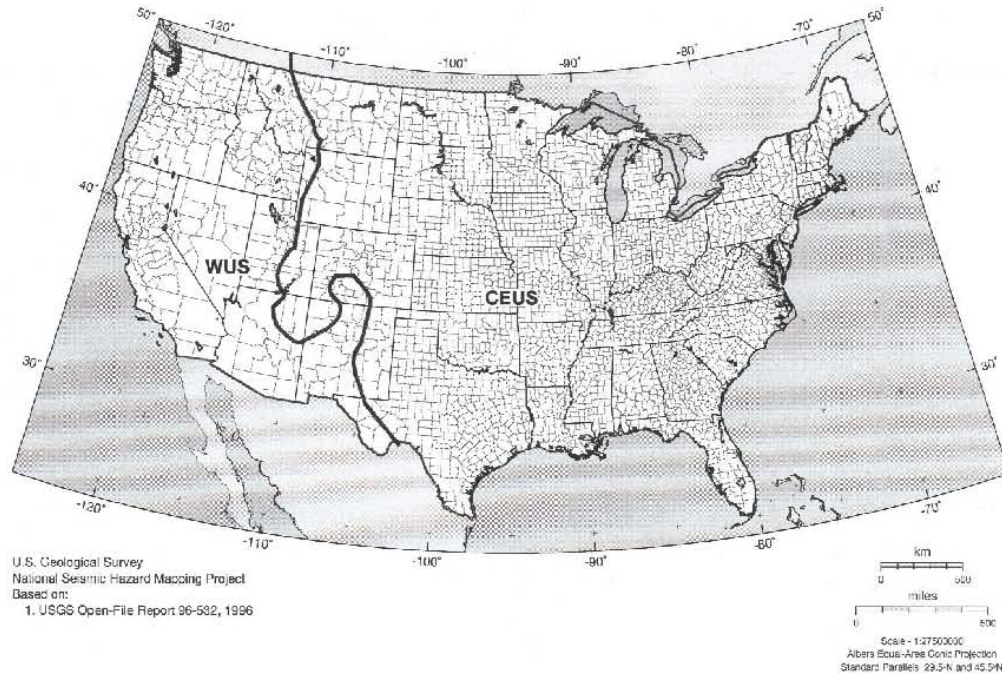

Figure B1 Attenuation boundary for eastern and western attenuation function.

Figure B2 is a sample of mean hazard curves used in making the 1996 maps. The curves include cities from various regions in the United States. It should be noted that in some areas the curves are very sensitive to the latitude and longitude selected. A probabilistic map is a contour plot of the ground motion or spectral values obtained by taking a “slice” through all 150,000 hazard curves at a particular probability value. The gridded data obtained from the hazard curves that was used to make each probabilistic map is located at the USGS Web site. Figure B2 also shows the general difference in slope of the hazard curves of the CEUS versus the WUS. This difference has been noted in other studies.

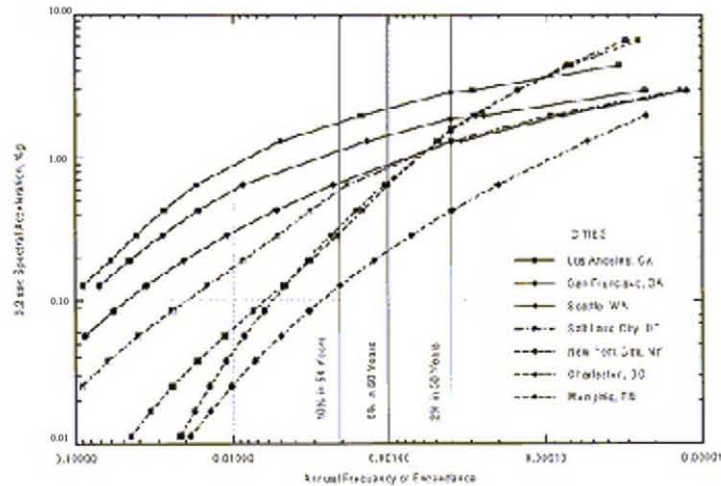

Figure B2 Hazard curves for selected cities.

CENTRAL AND EASTERN UNITED STATES

The basic procedure for constructing the CEUS portion of the hazard maps is diagrammed in Figure B3. Four models of hazard are shown on the left side of the figure. Model 1 is based on m_b 3.0 and larger earthquakes since 1924. Model 2 is derived from m_b 4.0 and larger earthquakes since 1860. Model 3 is produced from m_b 5.0 and larger events since 1700. In constructing the hazard maps, model 1 was assigned a weight twice that of models 2 and 3.

The procedure described by Frankel (1995) is used to construct the hazard maps directly from the historic seismicity (models 1-3). The number of events greater than the minimum magnitude are counted on a grid with spacing of 0.1 degrees in latitude and longitude. The logarithm of this number represents the maximum likelihood a-value for each grid cell. Note that the maximum likelihood method counts a m_b 5 event the same as a m_b 3 event in the determination of a-value. Then the gridded a-values are smoothed using a Gaussian function. A Gaussian with a correlation distance of 50 km was used for model 1 and 75 km for models 2 and 3. The 50 km distance was chosen because it is similar in width to many of the trends in historic seismicity in the CEUS. In addition, it is comparable to the

SEISMIC HAZARD MODELS FOR CENTRAL AND EASTERN U. S.

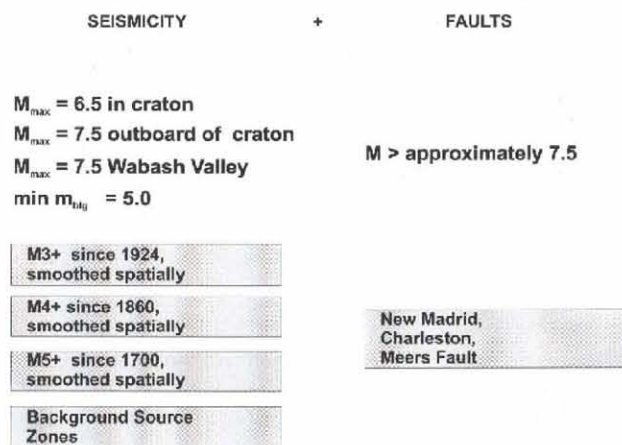

Figure B3 Seismic hazard models for the central and eastern United States. Smoothed seismicity models are shown on the left and fault models are shown on the right.

error in location of m_b 3 events in the period of 1924-1975, before the advent of local seismic networks. A larger correlation distance was used for models 2 and 3 since they include earthquakes further back in time with poorer estimates of locations.

Model 4 consists of large background source zones. This alternative is meant to quantify hazard in areas with little historical seismicity but with the potential to generate damaging earthquakes. These background zones are detailed in a later section of this text. The sum of the weights of models 1-4 is one. For a weighting scheme that is uniform in space, this ensures that the total seismicity rate in the combined model equals the historic seismicity rate. A spatially-varying weighting scheme which slightly exceeds the historic seismicity rate was used in the final map for reasons which are described later.

A regional b-value of 0.95 was used for models 1-4 in all of the CEUS except Charlevoix, Quebec. This b-value was determined from a catalog for events east of 105 degrees W. For the Charlevoix region a b-value of 0.76 was used based on the work of John Adams, Stephen Halchuck and Dieter Weichert of the Geologic Survey of Canada (see Adams et al., 1996).

Figure B4 shows a map of the CEUS M_{max} values used for models 1-4 (bold M refers to moment magnitude). These M_{max} zones correspond to the background zones used in model 4. Most of the CEUS is divided into a cratonic region and a region of extended crust. An M_{max} of 6.5 was used for the cratonic area. A M_{max} of 7.5 was used for the Wabash Valley zone in keeping with magnitudes derived from paleoliquefaction evidence (Obermeier et al., 1992). An M_{max} of 7.5 was used in the zone of extended crust outboard of the craton. An M_{max} of 6.5 was used for the Rocky Mountain zone and the Colorado Plateau, consistent with the magnitude of the largest historic events in these regions. An M_{max} of 7.2 was used for the gridded seismicity within the Charleston areal source zone. A minimum m_b of 5.0 was used in all the hazard calculations for the CEUS.

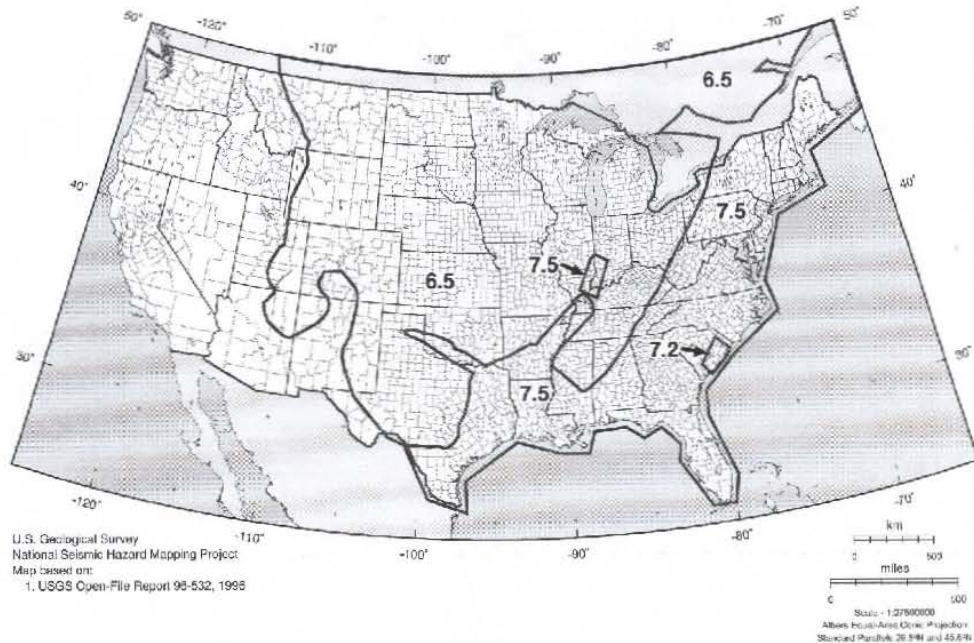

Figure B4 Central and eastern U.S. maximum magnitude zones.

Model 5 (Figure B3, right) consists of the contribution from large earthquakes ($M > 7.0$) in four specific areas of the CEUS: New Madrid, Charleston, South Carolina, the Meers fault in southwest Oklahoma, and the Cheraw Fault in eastern Colorado. This model has a weight of 1. The treatment of

these special areas is described below. There are three other areas in the CEUS that are called special zones: eastern Tennessee, Wabash Valley, and Charlevoix. These are described below.

Special zones A number of special case need to be described.

New Madrid: To calculate the hazard from large events in the New Madrid area, three parallel faults in an S-shaped pattern encompassing the area of highest historic seismicity were considered. These were not meant to be actual faults; they are simply a way of expressing the uncertainty in the source locations of large earthquakes such as the 1811-12 sequence. A characteristic rupture model with a characteristic moment magnitude M of 8.0, similar to the estimated magnitudes of the largest events in 1811-12 (Johnston, 1996a, 1996b) was assumed. A recurrence time of 1000 years for such an event was used as an average value, considering the uncertainty in the magnitudes of pre-historic events.

An areal source zone was used for New Madrid for models 1-3, rather than spatially-smoothed historic seismicity. This zone accounts for the hazard from New Madrid events with moment magnitudes less than 7.5.

Charleston, South Carolina: An areal source zone was used to quantify the hazard from large earthquakes. The extent of the areal source zone was constrained by the areal distribution of paleoliquefaction locations, although the source zone does not encompass all the paleoliquefaction sites. A characteristic rupture model of moment magnitude 7.3 earthquakes, based on the estimated magnitude of the 1886 event (Johnston, 1996b) was assumed. For the $M_{7.3}$ events a recurrence time of 650 years was used, based on dates of paleoliquefaction events (Amick and Gelinis, 1991; Obermeier et al., 1990; Johnston and Schweig, written comm., 1996).

Meers Fault: The Meers fault in southwestern Oklahoma was explicitly included. The segment of the fault which has produced a Holocene scarp as described in Crone and Luza (1990) was used. A characteristic moment magnitude of 7.0 and a recurrence time of 4000 years was used based on their work.

Cheraw Fault: This eastern Colorado fault with Holocene faulting based on a study by Crone et al. (1996) was included. The recurrence rate of this fault was obtained from a slip rate of 0.5 mm/yr. A maximum magnitude of 7.1 was found from the fault length using the relations of Wells and Coppersmith (1994).

Eastern Tennessee Seismic Zone: The eastern Tennessee seismic zone is a linear trend of seismicity that is most obvious for smaller events with magnitudes around 2 (see Powell et al., 1994). The magnitude 3 and larger earthquakes tend to cluster in one part of this linear trend, so that hazard maps are based just on smoothed m_b 3.

Wabash Valley: Recent work has identified several paleoearthquakes in the areas of southern Indiana and Illinois based on widespread paleoliquefaction features (Obermeier et al., 1992). An areal zone was used with a higher M_{max} of 7.5 to account for such large events. The sum of the gridded a -values in this zone calculated from model 1 produce a recurrence time of 2600 years for events with m_b 6.5. The recurrence rate of $M_{6.5}$ and greater events is estimated to be about 4,000 years from the paleoliquefaction dates (P. Munson and S. Obermeier, pers. comm., 1995), so it is not necessary to add additional large events to augment models 1-3. The Wabash Valley M_{max} zone in the maps is based on the Wabash Valley fault zone.

Charlevoix, Quebec: As mentioned above, a 40 km by 70 km region surrounding this seismicity cluster was assigned a b -value of 0.76, based on the work of Adams, Halchuck and Weichert. This b -value was used in models 1-3.

Background source zones (Model 4). The background source zones (see Figure B5) are intended to quantify seismic hazard in areas that have not had significant historic seismicity, but could very well produce sizeable earthquakes in the future. They consist of a cratonic zone, an extended margin zone, a Rocky Mountain zone, and a Colorado Plateau zone. The Rocky Mountain zone was not discussed at any workshop, but is clearly defined by the Rocky Mountain front on the east and the areas of

extensional tectonics to the west, north and south. As stated above, the dividing line between the cratonic and extended margin zone was drawn by Rus Wheeler based on the westward and northern edge of rifting during the opening of the Iapetan ocean. One justification for having craton and extended crust zones is the work done by Johnston (1994). They compiled a global survey of earthquakes in cratonic and extended crust and found a higher seismicity rate (normalized by area) for the extended areas.

For each background zone, a-values were determined by counting the number of $m_b \geq 3$ and larger events within the zone since 1924 and adjusting the rate to equal that since 1976. A b-value of 0.95 was used for all the background zones, based on the b-value found for the entire CEUS.

Adaptive weighting for CEUS. The inclusion of background zones lowers the probabilistic ground motions in areas of relatively high historic seismicity while raising the hazard to only low levels in areas with no historic seismicity. The June 1996 versions of the maps include the background zones using a weighting scheme that can vary locally depending on the level of historic seismicity in that cell of the a-value grid. Spatially-varying weighting was suggested by Allin Cornell in the external review of the interim maps. The “adaptive weighting” procedure avoids lowering the hazard in higher seismicity areas to raise the hazard in low seismicity areas. This was implemented by looping through the a-value grid and checking to see if the a-value for each cell from the historic seismicity was greater than the a-value from the background zone. For the CEUS the a-value from the historic seismicity was derived by weighting the rates from models 1, 2, and 3 by 0.5, 0.25, 0.25 respectively. If this weighted sum was greater than the rate from the appropriate background zone, then the rate for that cell was determined by weighting the rates from models 1-3 by 0.5, .25, .25 (i.e., historic seismicity only, no background zone). If the weighted sum from the historic seismicity was less than the rate of the background zone, then a weighting of 0.4, 0.2, 0.2, 0.2 for models 1-4, respectively (including the background zone as model 4). This procedure does not make the rate for any cell lower than it would be from the historic seismicity (models 1-3). It also incorporates the background zones in areas of low historic seismicity. The total seismicity rate in the resulting a-value grid is only 10 percent larger than the observed rate of $m_b \geq 3$'s since 1976. This is not a major difference. Of course, this procedure produces substantially higher ground motions (in terms of percentage increase) in the seismically quiet areas as compared to no background zone. These values are still quite low in an absolute sense.

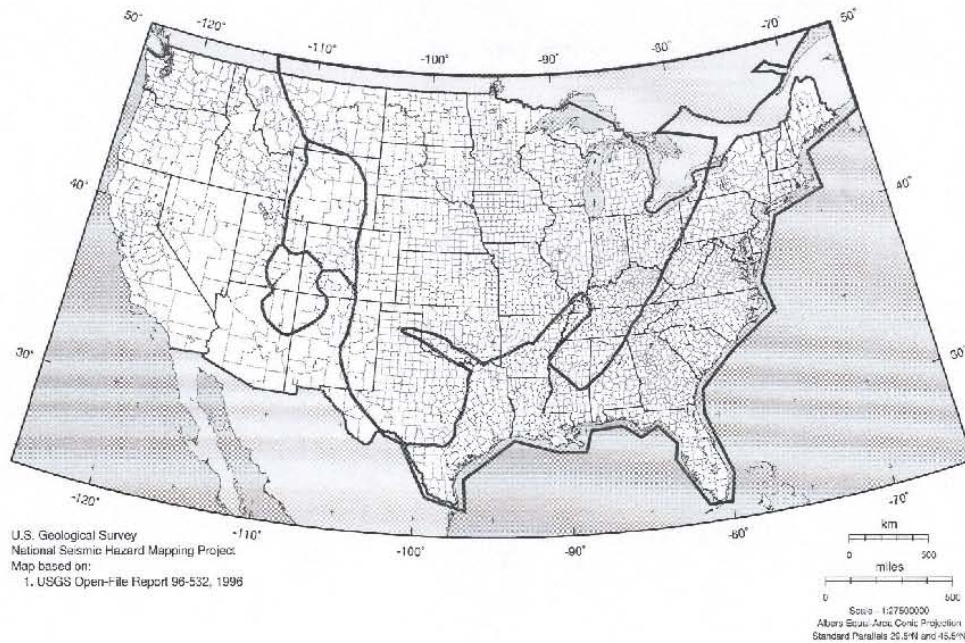

Figure B5 Central and eastern U.S. background zones.

CEUS catalogs and b-value calculation. The primary catalog used for the CEUS for longitudes east of 105 degrees is Seeber and Armbruster (1991), which is a refinement of the EPRI (1986) catalog. This was supplemented with the PDE catalog from 1985-1995. In addition, PDE, DNAG, Stover and Coffman (1993), Stover, Reagor, and Algermissen (1984) catalogs were searched to find events not included in Seeber and Armbruster (1991). Mueller et al. (1996) describes the treatment of catalogs, adjustment of rates to correct for incompleteness, the removal of aftershocks, and the assignment of magnitudes.

Attenuation relations for CEUS. The reference site condition used for the maps is specified to be the boundary between *Provisions* Site Classes B and C (Martin and Dobry, 1994), meaning it has an average shear-wave velocity of 760 m/sec in the top 30m. This corresponds to a typical “firm-rock” site for the western United States (see WUS attenuation section below), although many rock sites in the CEUS probably have much higher velocities. The motivation for using this reference site is that it corresponds to the average of sites classified as “rock” sites in WUS attenuation relations. In addition, it was considered less problematic to use this site condition for the CEUS than to use a soil condition. Most previously-published attenuation relations for the CEUS are based on a hard-rock site condition. It is less of a problem to convert these to a firm-rock condition than to convert them to a soil condition, since there would be less concern over possible non-linearity for the firm-rock site compared to the soil site.

Two equally-weighted, attenuation relations were used for the CEUS. Both sets of relations were derived by stochastic simulations and random vibration theory. First the Toro et al. (1993) attenuation for hard-rock was used. The attenuation relations were multiplied by frequency-dependent factors developed by USGS to convert them from hard-rock to firm-rock sites. The factors used 1.52 for PGA, 1.76 for 0.2 sec spectral response, 1.72 for 0.3 sec spectral response and 1.34 for 1.0 sec spectral response. These factors were applied independently of magnitude and distance.

The second set of relations was derived by USGS (Frankel et al., 1996) for firm-rock sites. These relations were based on a Brune source model with a stress drop of 150 bars. The simulations contained frequency-dependent amplification factors derived from a hypothesized shear-wave velocity

profile of a CEUS firm-rock site. A series of tables of ground motions and response spectral values as a function of moment magnitude and distance was produced instead of an equation.

For CEUS hazard calculations for models 1-4, a source depth of 5.0 km was assumed when using the USGS ground motion tables. Since a minimum hypocentral distance of 10 km is used in the USGS tables, the probabilistic ground motions are insensitive to the choice of source depth. In the hazard program, when hypocentral distances are less than 10 km the distance is set to 10 km when using the tables. For the Toro et al. (1993) relations, the fictitious depths that they specify for each period are used, so that the choice of source depth used in the USGS tables was not applied.

For both sets of ground motion relations, values of 0.75, 0.75, 0.75, and 0.80 were used for the natural logarithms of the standard deviation of PGA, 0.2 sec, 0.3 sec, and 1.0 sec spectral responses, respectively. These values are similar to the aleatory standard deviations reported to the Senior Seismic Hazard Analysis Committee (1996).

A cap in the median ground motions was placed on the ground motions within the hazard code. USGS was concerned that the median ground motions of both the Toro et al. and the new USGS tables became very large ($> 2.5g$ PGA) for distances of about 10 km for the M 8.0 events for New Madrid. Accordingly the median PGA's was capped at 1.5g. The median 0.3 and 0.2 sec values were capped at 3.75g which was derived by multiplying the PGA cap by 2.5 (the WUS conversion factor). This only affected the PGA values for the 2 percent PE in 50 year maps for the area directly above the three fictitious faults for the New Madrid region. It does not change any of the values at Memphis. The capping did not significantly alter the 0.3 and 0.2 sec values in this area. The PGA and spectral response values did not change in the Charleston region from this capping. Note that the capping was for the median values only. As the variability (σ) of the ground motions was maintained in the hazard code, values larger than the median were allowed. USGS felt that the capping recognizes that values derived from point source simulations are not as reliable for M8.0 earthquakes at close-in distances (< 20 km).

Additional notes for CEUS. One of the major outcomes of the new maps for the CEUS is that the ground motions are about a factor of 2 to 3 times lower, on average, than the PGA values in Algermissen et al. (1990) and the spectral values in Algermissen et al. (1991) and Leyendecker et al. (1995). The primary cause of this difference is the magnitudes assigned to pre-instrumental earthquakes in the catalog. Magnitudes of historic events used by Algermissen et al. were based on I_{max} (maximum observed intensity), using magnitude- I_{max} relations derived from WUS earthquakes. This overestimates the magnitudes of these events and, in turn, overestimates the rates of M4.9 and larger events. The magnitudes of historic events used in the new maps were primarily derived by Seeber and Armbruster (1991) from either felt area or I_{max} using relations derived from CEUS earthquakes (Sibol et al., 1987). Thus, rates of M4.9 and larger events are much lower in the new catalog, compared to those used for the previous USGS maps.

It is useful to compare the new maps to the source zones used in the EPRI (1986) study. For the areas to the north and west of New Madrid, most of the six EPRI teams had three source zones in common: 1) the Nemaha Ridge in Kansas and Nebraska, 2) the Colorado-Great Lakes lineament extending from Colorado to the western end of Lake Superior, and 3) a small fault zone in northern Illinois, west of Chicago. Each of these source zones are apparent as higher hazard areas in the our maps. The Nemaha Ridge is outlined in the maps because of magnitude 4 and 5 events occurring in the vicinity. Portions of the Colorado-Great Lakes lineament show higher hazard in the map, particularly the portion in South Dakota and western Minnesota. The portion of the lineament in eastern Minnesota has been historically inactive, so is not apparent on the maps. The area in western Minnesota shows some hazard because of the occurrence of a few magnitude 4 events since 1860. A recent paper by Chandler (1995), argues that the locations and focal mechanisms of these earthquakes are not compatible with them being on the lineament, which is expressed as the Morris Fault in this region. The area in northern Illinois has relatively high hazard in the maps because of M4-5 events that have occurred there.

Frankel (1995) also found good agreement in the mean PE's and hazard curves derived from models 1-3 and 4 and those produced by the EPRI (1986) study, when the same PGA attenuation relations were used.

WESTERN UNITED STATES

The maps for the WUS include a cooperative effort with the California Division of Mines and Geology. This was made possible, in part, because CDMG was doing a probabilistic map at the same time the USGS maps were prepared. There was considerable cooperation in this effort. For example, the fault data base used in the USGS maps was obtained from CDMG. Similarly USGS software was made available to CDMG. The result is that maps produced by both agencies are the same.

The procedure for mapping hazard in the WUS is shown in Figure B6. On the left side, hazards are considered from earthquakes with magnitudes less than or equal to moment magnitude 7.0. For most of the WUS, two alternative models are used: 1) smoothed historical seismicity (weight of 0.67) and 2) large background zones (weight 0.33) based on broad geologic criteria and workshop input. Model 1 used a 0.1 degree source grid to count number of events. The determination of a-value was changed somewhat from the CEUS, to incorporate different completeness times for different magnitude ranges. The a-value for each grid cell was calculated from the maximum likelihood method of Weichert (1980), based on events with magnitudes of 4.0 and larger. The ranges used were M4.0 to 5.0 since 1963, M5.0 to 6.0 since 1930, and M6.0 and larger since 1850. For the first two categories, completeness time was derived from plots of cumulative number of events versus time. M3 events were not used in the WUS hazard calculations since they are only complete since about 1976 for most areas and may not even be complete after 1976 for some areas. For California M4.0 to M5.0 since 1933, M5.0 to 6.0 since 1900, and M6.0 and larger since 1850 were used. The catalog for California is complete to earlier dates compared to the catalogs for the rest of the WUS (see below).

Another difference with the CEUS is that multiple models with different minimum magnitudes for the a-value estimates (such as models 1-3 for the CEUS) were not used. The use of such multiple models in the CEUS was partially motivated by the observation that some m_b4 and m_b5 events in the CEUS occurred in areas with few m_b3 events since 1924 (e.g., Nemaha Ridge events and western Minnesota events). It was considered desirable to be able to give such m_b4 and m_b5 events extra weight in the hazard calculation over what they would have in one run with a minimum magnitude of 3. In contrast it appears that virtually all M5 and M6 events in the WUS have occurred in areas with numerous M4 events since 1965. There was also reluctance to use a WUS model with a-values based on a minimum magnitude of 6.0, since this would tend to double count events that have occurred on mapped faults included in Figure B6 right.

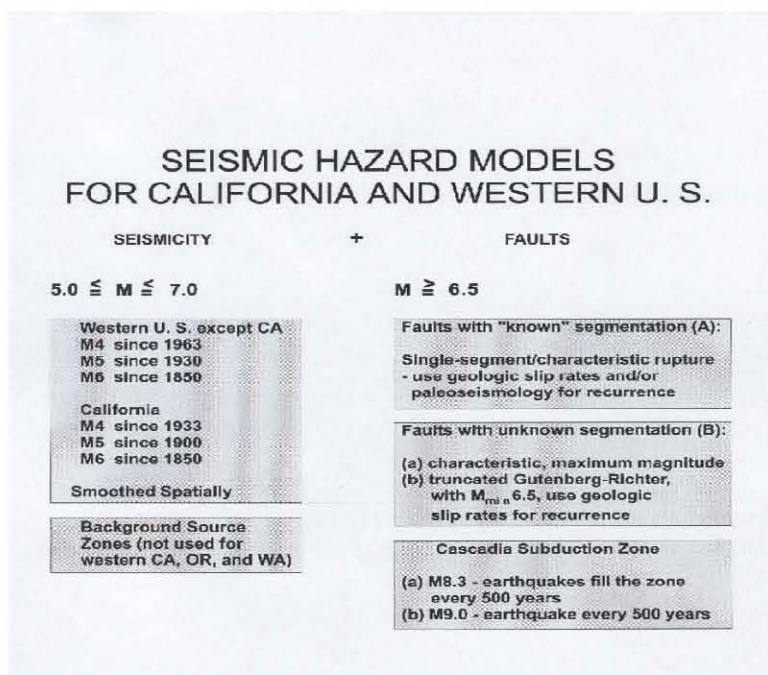

Figure B6 Seismic hazard models for California and the western United States. Smoothed seismicity models are shown on the left and fault models are shown on the right.

For model 1, the gridded a-values were smoothed with a Gaussian with a correlation distance of 50 km, as in model 1 for the CEUS. The hazard calculation from the gridded a-values differed from that in the CEUS, because we considered fault finiteness in the WUS calculations. For each source grid cell, a fictitious fault for magnitudes of 6.0 and larger was used. The fault was centered on the center of the grid cell. The strike of the fault was random and was varied for each magnitude increment. The length of the fault was determined from the relations of Wells and Coppersmith (1994). The fictitious faults were taken to be vertical.

A maximum moment magnitude of 7.0 was used for models 1 and 2, except for four shear zones in northeastern California and western Nevada described below. Of course, larger moment magnitudes are included in the specific faults. A minimum moment magnitude of 5.0 were used for models 1 and 2. For each WUS site, the hazard calculation was done for source-site distances of 200 km and less, except for the Cascadia subduction zone, where the maximum distance was 1000 km.

Separate hazard calculations for deep events (> 35 km) were done. These events were culled from the catalogs. Their a-values were calculated separately from the shallow events. Different attenuation relations were used.

Regional b-values were calculated based on the method of Weichert (1980), using events with magnitudes of 4 and larger and using varying completeness times for different magnitudes. Accordingly, a regional b-value of 0.8 was used in models 1 and 2 for the WUS runs based on shallow events. For the deep events (> 35 km), an average b-value of 0.65 was found. This low b-value was used in the hazard calculations for the deep events.

We used a b-value of 0.9 for most of California, except for the easternmost portion of California in our basin and range background zone (see below). This b-value was derived by CDMG.

Faults. The hazard from about 500 Quaternary faults or fault segments was used for the maps. Faults were considered where geologic slip rates have been determined or estimates of recurrence times have been made from trenching studies. A table of the fault parameters used in the hazard calculations has been compiled and is shown on the USGS Internet Web site. Figure B7 shows the faults used in the maps. The numerous individuals who worked on compilations of fault data are too numerous to cite here. They are cited, along with their contribution, in the map documentation (Frankel et al, 1996).

Recurrence models for faults. The hazard from specific faults is added to the hazard from the seismicity as shown in Figure B6. Faults are divided into types A and B, roughly following the nomenclature of WGCEP (1995). A fault is classified as A-type if there have been sufficient studies of it to produce models of fault segmentation. In California the A-type faults are: San Andreas, San Jacinto, Elsinore, Hayward, Rodgers Creek, and Imperial (M. Petersen, C. Cramer, and W. Bryant, written comm., 1996). The only fault outside of California classified as an A-type is the Wasatch Fault. Single-segment ruptures were assumed on the Wasatch Fault.

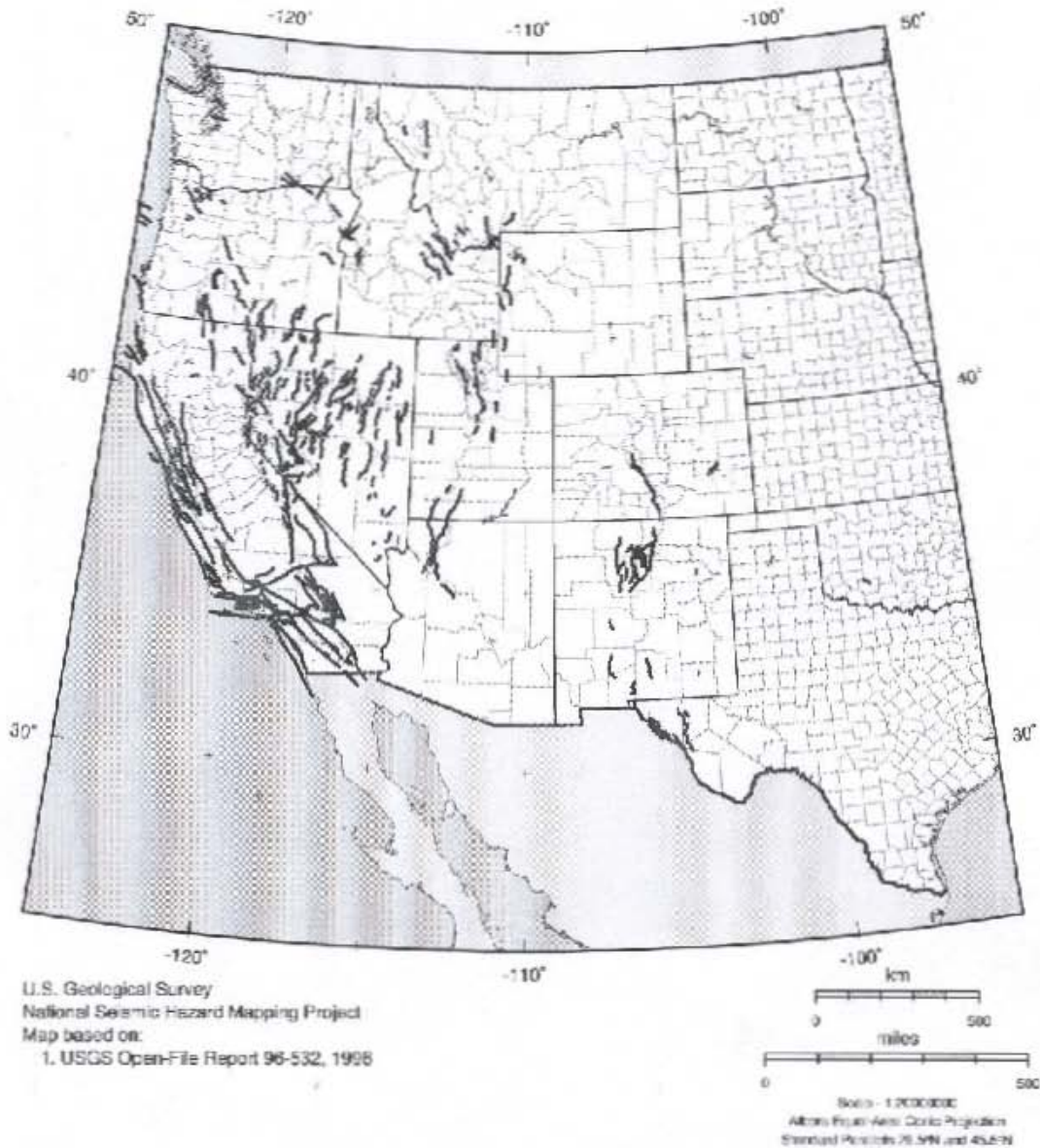

Figure B7 Western U.S. faults included in the maps.

For California, the rupture scenarios specified by Petersen, Cramer and Bryant of CDMG, with input from Lienkaemper of USGS for northern California were used. Single-segment, characteristic rupture for the San Jacinto and Elsinore faults were assumed. For the San Andreas fault, multiple-segment ruptures were included in the hazard calculation, including repeats of the 1906 and 1857 rupture zones, and a scenario with the southern San Andreas fault rupturing from San Bernardino through the Coachella segment. Both single-segment and double-segment ruptures of the Hayward Fault were included.

For California faults, characteristic magnitudes derived by CDMG from the fault area using the relations in Wells and Coppersmith (1994) were used. For the remainder of the WUS, the characteristic magnitude was determined from the fault length using the relations of Wells and Coppersmith (1994) appropriate for that fault type.

For the B-type faults, it was felt there were insufficient studies to warrant specific segmentation boundaries. For these faults, the scheme of Petersen et al. (1996) was followed, using both characteristic and Gutenberg-Richter (G-R; exponential) models of earthquake occurrence. These recurrence models were weighted equally. The G-R model basically accounts for the possibility that a fault is segmented and may rupture only part of its length. It was assumed that the G-R distribution applies from a minimum moment magnitude of 6.5 up to a moment magnitude corresponding to rupture of the entire fault length.

The procedure for calculating hazard using the G-R model involves looping through magnitude increments. For each magnitude a rupture length is calculated using Wells and Coppersmith (1994). Then a rupture zone of this length is floated along the fault trace. For each site, the appropriate distance to the floating ruptures is found and the frequency of exceedance (FE) is calculated. The FE's are then added for all the floating rupture zones.

As used by USGS, the characteristic earthquake model (Schwartz and Coppersmith, 1984) is actually the maximum magnitude model of Wesnousky (1986). Here it is assumed that the fault only generates earthquakes that rupture the entire fault. Smaller events along the fault would be incorporated by models 1 and 2 with the distributed seismicity or by the G-R model described above.

It should be noted that using the G-R model generally produces higher probabilistic ground motions than the characteristic earthquake model, because of the more frequent occurrence of earthquakes with magnitudes of about 6.5.

Fault widths (except for California) were determined by assuming a seismogenic depth of 15 km and then using the dip, so that the width equaled 15 km divided by the sine of the dip. For most normal faults a dip of 60 degrees is assumed. Dip directions were taken from the literature. For the Wasatch, Lost River, Beaverhead, Lemhi, and Hebgen Lake faults, the dip angles were taken from the literature (see fault parameter table on Web site). Strike-slip faults were assigned a dip of 90 degrees. For California faults, widths were often defined using the depth of seismicity (J. Lienkaemper, written comm., 1996; M. Petersen, C. Cramer, and W. Bryant, written comm., 1996). Fault length was calculated from the total length of the digitized fault trace.

Special cases. There are a number of special cases which need to be described.

Blind thrusts in the Los Angeles area: Following Petersen et al. (1996) and as discussed at the Pasadena workshop, 0.5 weight was assigned to blind thrusts in the L.A. region, because of the uncertainty in their slip rates and in whether they were indeed seismically active. These faults are the Elysian Park thrust and the Compton thrust. The Santa Barbara Channel thrust (Shaw and Suppe, 1994) also has partial weight, based on the weighting scheme developed by CDMG.

Offshore faults in Oregon: A weight of 0.05 was assigned to three offshore faults in Oregon identified by Goldfinger et al. (in press) and tabulated by Geomatrix (1995): the Wecoma, Daisy Bank and Alvin Canyon faults. It was felt the uncertainty in the seismic activity of these faults warranted a low weight, and the 0.05 probability of activity decided in Geomatrix (1995) was used. A 0.5 weight was assigned to the Cape Blanco blind thrust.

Lost River, Lemhi and Beaverhead faults in Idaho: It was assumed that the magnitude of the Borah Peak event (M7.0) represented a maximum magnitude for these faults. As with (3), the characteristic model floated a M7.0 along each fault. The G-R model considered magnitudes between 6.5 and 7.0. Note that using a larger maximum magnitude would lower the probabilistic ground motions, because it would increase the recurrence time.

Hurricane and Sevier-Torroweap Faults in Utah and Arizona: The long lengths of these faults (about 250 km) implied a maximum magnitude too large compared to historical events in the region. Therefore a maximum magnitude of M7.5 was chosen. The characteristic and G-R models were implemented as in case (3). Other faults (outside of California) where the M_{max} was determined to be greater than 7.5 based on the fault length were assigned a maximum magnitude of 7.5.

Wasatch Fault in Utah: Recurrence times derived from dates of paleoearthquakes by Black et al. (1995) and the compilation of McCalpin and Nishenko (1996) were used

Hebgen Lake Fault in Montana: A characteristic moment magnitude of 7.3 based on the 1959 event (Doser, 1985) was used.

Short faults: All short faults with characteristic magnitudes of less than 6.5 were treated with the characteristic recurrence model only (weight = 1). No G-R relation was used. If a fault had a characteristic magnitude less than 6.0, it was not used.

Seattle Fault: The characteristic recurrence time was fixed at 5000 years, which is the minimum recurrence time apparent from paleoseismology (R. Bucknam, pers. comm., 1996). Using the characteristic magnitude of 7.1 derived from the length and a 0.5 mm/yr slip rate yielded a characteristic recurrence time of about 3000 years.

Eglington fault near Las Vegas: The recurrence time for this fault was fixed at 14,000 years, similar to the recurrence noted in Wyman et al. (1993).

Shear Zones in Eastern California and Western Nevada: Areal shear zones were added along the western border of Nevada extending from the northern end of the Death Valley fault through the Tahoe-Reno area through northeast California ending at the latitude of Klamath Falls, Oregon. A shear rate of 4 mm/yr to zone 1, and 2 mm/yr to zones 2 and 3 was assigned. The shear rate in zone 1 is comparable to the shear rate observed on the Death Valley fault, but which is not observed in mapped faults north of the Death Valley fault (C. dePolo and J. Anderson, pers. comm., 1996). For the Foothills Fault system (zone 4) a shear rate of 0.05 mm/yr was used. *a*-values were determined for these zones in the manner described in Ward(1994). For zones 1 through 3, a magnitude range of 6.5 to 7.3 was used. For zone 4, a magnitude range of 6.0 to 7.0 was used. The maximum magnitude for the calculation of hazard from the smoothed historic seismicity was lowered in these zones so that it did not overlap with these magnitude ranges. Fictitious faults with a fixed strike were used in the hazard calculation for these zones. Again, use of these areal zones in California was agreed upon after consultation with CDMG personnel.

Cascadia subduction zone. Two alternative scenarios for great earthquakes on the Cascadia subduction zone were considered. For both scenarios it was assumed that the recurrence time of rupture at any point along the subduction zone was 500 years. This time is in or near most of the average intervals estimated from coastal and offshore evidence (see Atwater and Hemphill-Haley, 1996; Geomatrix, 1995; B. Atwater, written comm., 1996). Individual intervals, however, range from a few hundred years to about 1000 years (Atwater et al., 1995).

The first scenario is for moment magnitude 8.3 earthquakes to fill the subduction zone every 500 years. Based on a rupture length of 250 km (see Geomatrix, 1995) for an M8.3 event and the 1100 km length of the entire subduction zone, this requires a repeat time of about 110 years for an M8.3 event. However, no such event has been observed in the historic record of about 150 years. This M8.3 scenario is similar to what was used in the 1994 edition of the USGS maps (see Leyendecker et al., 1995) and it is comparable to the highest weighted scenario in Geomatrix (1995). A M8.3 rupture zone was floated along the strike of the subduction zone to calculate the hazard. A weight of 0.67 was assigned for this scenario in the maps.

The second scenario used is for a moment magnitude 9.0 earthquake to rupture the entire Cascadia subduction zone every 500 years on average. No compelling reason was seen to rule out such a scenario. This scenario would explain the lack of M8 earthquakes in the historic record. It is also consistent with a recent interpretation of Japanese tsunami records by Satake et al. (1996). By ruling out alternative source regions, Satake et al. (1996) reported that a tsunami in 1700 could have been produced by a M9.0 earthquake along the Cascadia subduction zone. A weight of 0.33 was assigned to the M9.0 scenario in the maps.

The subduction zone was specified as a dipping plane striking north-south from about Cape Mendocino to 50 degrees north. It was assumed that the plane reached 20 km depth at a longitude of

123.8 degrees west, just east of the coastline. This corresponds roughly to the 20 km depth contour drawn by Hyndman and Wang (1995) and is consistent with the depth and location of the Petrolia earthquake in northern California. A dip of 10 degrees was assigned to the plane and a width of 90 km. The seismogenic portion of the plane was assumed to extend to a depth of 20 km.

Background source zones. The background source zones for the WUS (model 2) were based on broad geologic criteria and were developed by discussion at the Salt Lake City (SLC) workshop (except for the Cascades source zone). These zones are shown in Figure B8. Note that there are no background source zones west of the Cascades and west of the Basin and Range province. For those areas, model 1 was used with a weight of 1.

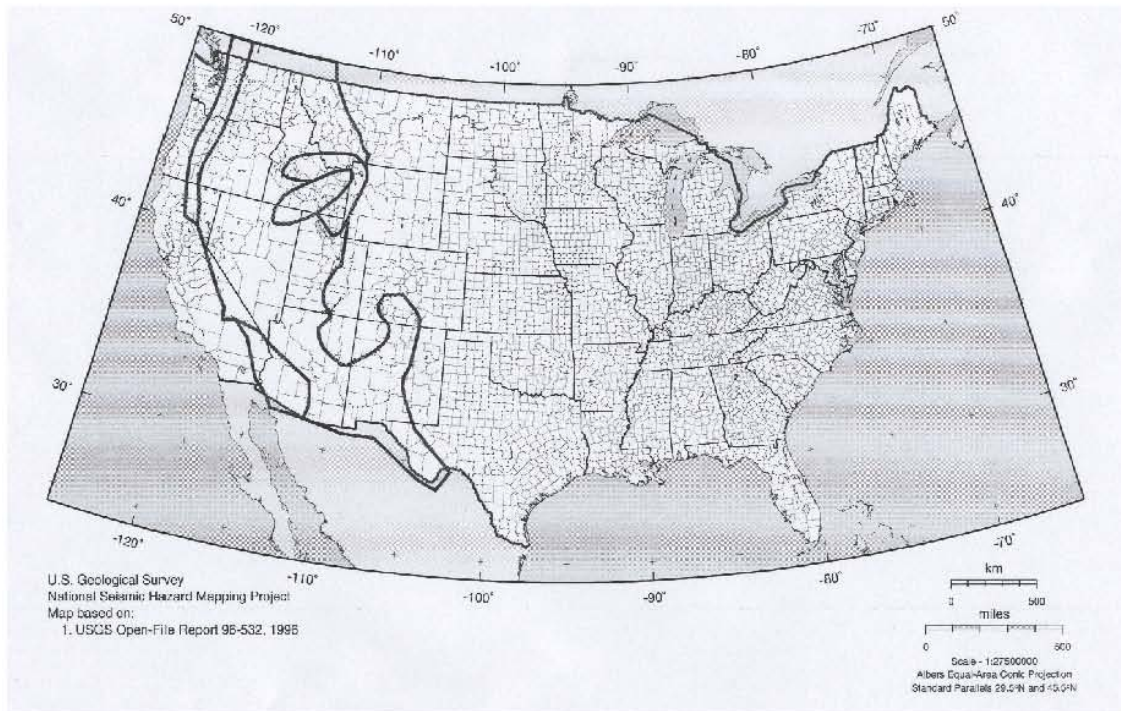

Figure B8 Western U.S. background zones.

At the SLC workshop there was substantial sentiment for a Yellowstone Parabola source zone (see, e.g., Anders et al., 1989) that would join up seismically-active areas in western Wyoming with the source areas of the Bora Peak and Hebgen Lake earthquakes. It was felt that the relatively seismically-quiet areas consisting of the Snake River Plain and Colorado Plateau should be separate source zones because of the geologic characteristics. An area of southwest Arizona was suggested as a separate source zone by Bruce Scheol, based partly on differences in the age and length of geologic structures compared with the Basin and Range Province (see Edge et al., 1992). A Cascades source zone was added since it was felt that was a geologically-distinct area.

The remaining background source zone includes the Basin and Range Province, the Rio Grande Rift, areas of Arizona and New Mexico, portions of west Texas, and areas of eastern Washington and northern Idaho and Montana. The northern border of this zone follows the international border. As stated above, this seems to be a valid approach since the hazard maps are being based on the seismicity rate in the area of interest.

This large background zone is intended to address the possibility of having large earthquakes (M6 and larger) in areas with relatively low rates of seismicity in the brief historic record. It is important to have a large zone that contains areas of high seismicity in order to quantify the hazard in relatively quiet areas such as eastern Oregon and Washington, central Arizona, parts of New Mexico, and

west Texas. One can see the effect of this large background zone by noting the contours on the hazard maps in these areas. The prominence of the background zones in the maps is determined by the weighting of models 1 and 2.

Adaptive weighting for the WUS. The adaptive weighting procedure was used to include the background zones in the WUS without lowering the hazard values in the high seismicity areas. As with the CEUS, the *a*-value was checked for each source cell to see whether the rate from the historic seismicity exceeded that from the appropriate background zone. If it did, the *a*-value was used from the historic seismicity. If the historic seismicity *a*-value was below the background value, then a rate derived from using 0.67 times the historic rate plus 0.33 times the background rate was used. This does not lower the *a*-value in any cell lower than the value from the historic seismicity. The total seismicity rate in this portion of the WUS in the new *a*-value grid is 16 percent above the historic rate (derived from M4 and greater events since 1963).

WUS catalogs. For the WUS, except for California, the Stover and Coffman (1993), Stover, Reagor, and Algermissen (1984), PDE, and DNAG catalogs (with the addition of Alan Sanford's catalog for New Mexico) were used. For California, a catalog compiled by Mark Petersen of California Division of Mines and Geology (CDMG) was used. Mueller et al. (1996) describes the processing of the catalogs, the removal of aftershocks, and the assignment of magnitudes. Utah coal-mining events were removed from the catalog (see Mueller et al., 1996). Explosions at NTS and their aftershocks were also removed from the catalog.

Attenuation relations for WUS. These relations are discussed below.

Crustal Events: For spectral response acceleration, three equally-weighted attenuation relations were used: (1) Boore, Joyner, and Fumal (BJF; 1993, 1994a) with later modifications to differentiate thrust and strike-slip faulting (Boore et al., 1994b) and (2) Sadigh et al. (1993). For (1) ground motions were calculated for a site with average shear-wave velocity of 760 m/sec in the top 30m, using the relations between shear-wave velocity and site amplification in Boore et al. (1994a). For (2) their "rock" values were used. Joyner (1995) reported velocity profiles compiled by W. Silva and by D. Boore showing that WUS rock sites basically spanned the NEHRP B/C boundary. When calculating ground motions for each fault, the relations appropriate for that fault type (e.g, thrust) were used. All of the relations found higher ground motions for thrust faults compared with strike slip faults.

All calculations included the variability of ground motions. For 1) the sigma values reported in BJF (1994b) were used. For 2) the magnitude-dependent sigmas found in those studies were used.

The distance measure from fault to site varies with the attenuation relation and this was accounted for in the hazard codes (see B.5 for additional detail on distance measures).

Deep events (> 35 km): Most of these events occurred beneath the Puget Sound region, although some were in northwestern California. For these deep events, only one attenuation relation was used – that is, that developed by Geomatrix (1993; with recent modification for depth dependence provided by R. Youngs, written comm., 1996), which is based on empirical data of deep events recorded on rock sites. The relations of Crouse (1991) were used because they were for soil sites. It was found that the ground motions from Geomatrix (1993) are somewhat smaller than those from Crouse (1991), by an amount consistent with soil amplification. These events were placed at a depth of 40 km for calculation of ground motions.

Cascadia subduction zone: For M8.3 events on the subduction zone, two attenuation relations (with equal weights) were used following the lead of Geomatrix (1993): 1) Sadigh et al. (1993) for crustal thrust earthquakes and 2) Geomatrix (1993) for interface earthquakes. For the M9.0 scenario, Sadigh et al. (1993) formulas could not be used since they are invalid over M8.5. Therefore, only Geomatrix (1993) was used. Again the values from Geomatrix (1993) were somewhat smaller than the soil values in Crouse (1991).

ALASKA

The basic procedure, shown in Figure B9, for constructing the Alaska hazard maps is similar to that previously described for the WUS. The maps have been completed and both the maps and documentation (USGS, 1998a, 1998b) have been placed on the USGS internet site (<http://geohazards.cr.usgs.gov/eq/>); printing of the maps is in progress.

Faults. The hazard from nine faults was used for the maps (Figure B10). Faults were included in the map when an estimated slip rate was available. The seismic hazard associated with faults not explicitly included in the map is captured to a large degree by the smoothed seismicity model. Specific details on the fault parameters are given in USGS, 1997a. All of the faults except one were strike-slip faults.

Recurrence models for faults. As was done for the western U.S., faults were divided into types A and B. The fault treatment was the same as the WUS. Type A faults were the Queen Charlotte, Fairweather offshore, Fairweather onshore, and Transition fault. Type B faults included western Denali, eastern Denali, Totshunda, and Castle Mountain.

For the type B faults, both characteristic and Gutenberg-Richter (G-R) models of earthquake

occurrence were used. These recurrence models were weighted equally. The G-R model accounts for the possibility that a fault is segmented and may rupture only part of its length. It was assumed that the G-R distribution applies from a minimum moment magnitude of 6.5 up to a moment magnitude corresponding to rupture of the entire fault length.

Special case. The Transition fault was treated as a Type A fault even though its segmentation is unknown. Although the rationale for this treatment is documented in USGS, 1998a, it should be pointed out that the parameters, such as segmentation and slip rate, associated with this fault are highly uncertain.

Megathrust. The Alaska-Aleutian megathrust was considered in four parts, shown in Figure B11. Specific rationale for the use of these boundaries is complex and is described in USGS, 1998a.

Alaska catalogs. A new earthquake catalog was built by combining Preliminary Determination of Epicenter, Decade of North American Geology, and International Seismological Centre catalogs with USGS interpretations of catalog reliability. Mueller et al. (1997) describes the processing of the catalogs, the removal of aftershocks, and the assignment of magnitudes.

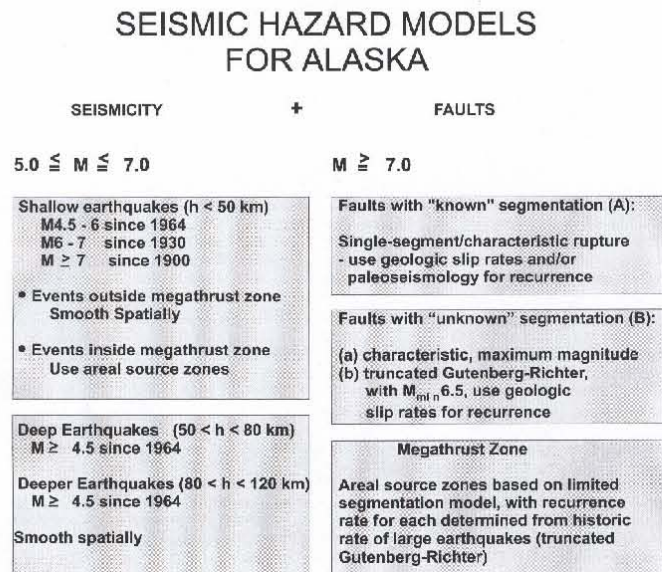

Figure B9 Seismic hazard models for Alaska. Smoothed seismicity models are shown on the left and fault models are shown on the right.

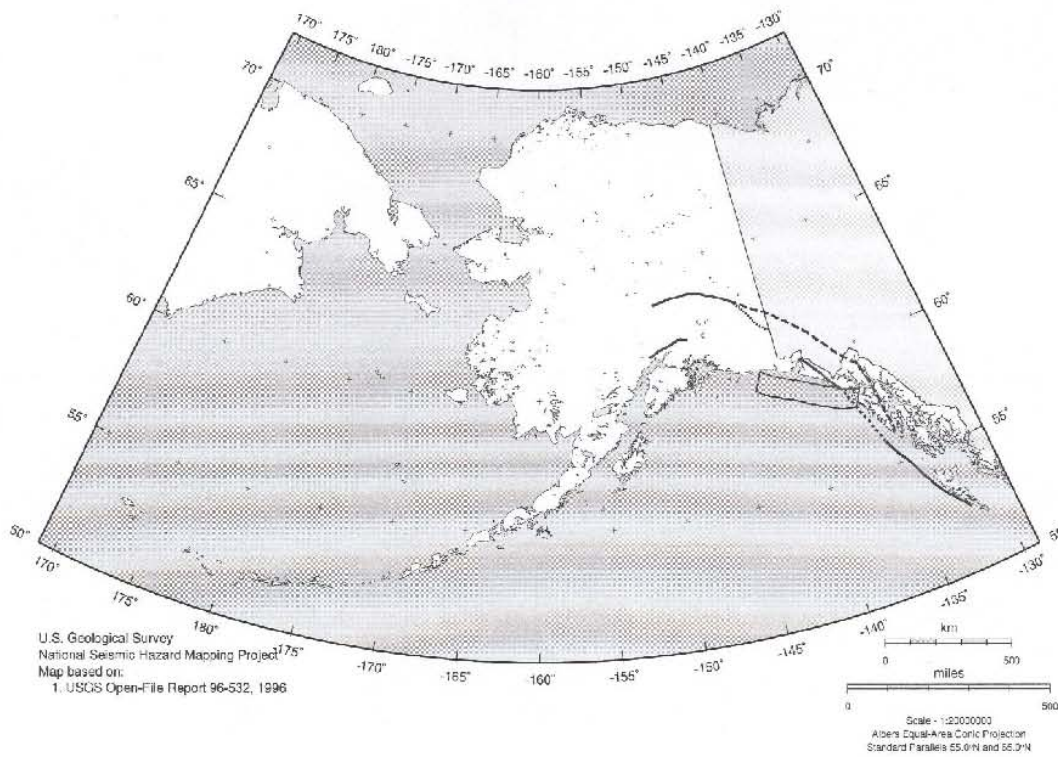

Figure B10 Faults included in the maps. Faults are shown with different line types for clarity. Dipping faults are shown as closed polygons.

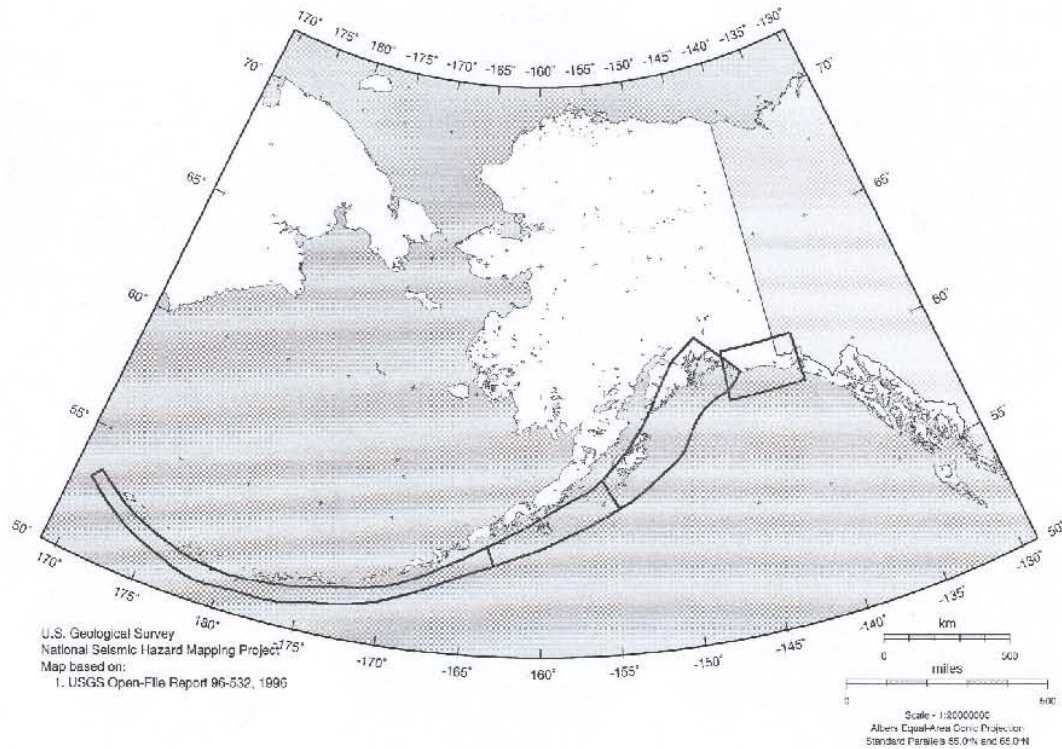

Figure B11 Subduction zones included in the maps

Attenuation relations for Alaska

Crustal Events: For spectral response acceleration, two equally-weighted attenuation relations were used: (1) Boore, Joyner, and Fumal (BJF; 1997) and (2) Sadigh et al. (1997). For (1) ground motions were calculated for a site with average shear-wave velocity of 760 m/sec in the top 30m. For (2) their “rock” values were used. These are recent publication of the attenuations cited for the WUS. The attenuations are the same. When calculating ground motions for each fault, the relations appropriate for that fault type (e.g. strike slip) were used. All calculations included the variability of ground motions.

Deep events (50 - 80 km): For these deep events, only one attenuation relation was used, the intraslab form of Youngs et al. (1997) with a depth fixed at 60 km.

Deeper events (80 - 120 km): For these deeper events, only one attenuation relation was used, the intraslab form of Youngs et al. (1997) with a depth fixed at 90 km.

Megathrust and Transition Fault: Only one attenuation relation was used, the interslab form of Youngs et al. (1997). It should be noted that the use of this attenuation for the Transition fault resulted in lower ground motions than would have been obtained using the crustal attenuation equations.

PROBABILISTIC MAPS

Two of the probabilistic maps were key to the decisions made by the SDPG for developing the maximum considered earthquake ground motion maps. These are the 0.2 sec and 1.0 sec spectral response maps for a 2 percent probability of exceedance in 50 years. These are shown in Figures B12 and B13 respectively. The way in which these maps were used is described in the following sections.

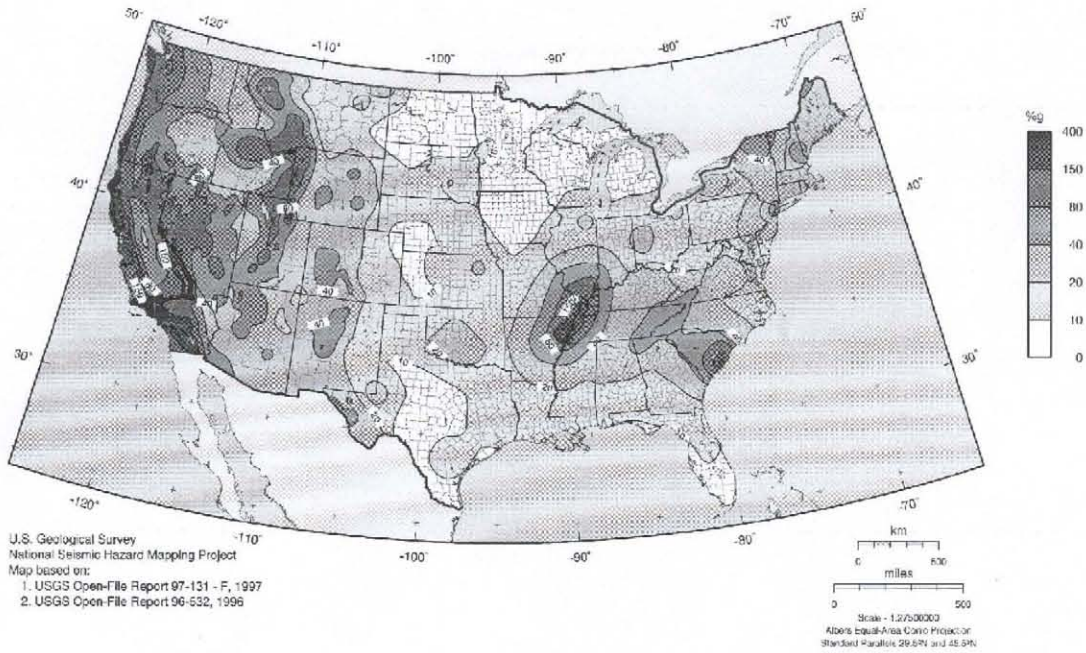

Figure B12 Probabilistic map of 0.2 sec spectral response acceleration with a 2% probability of exceedance in 50 years. The reference site material has a shear wave velocity of 750 m/sec.

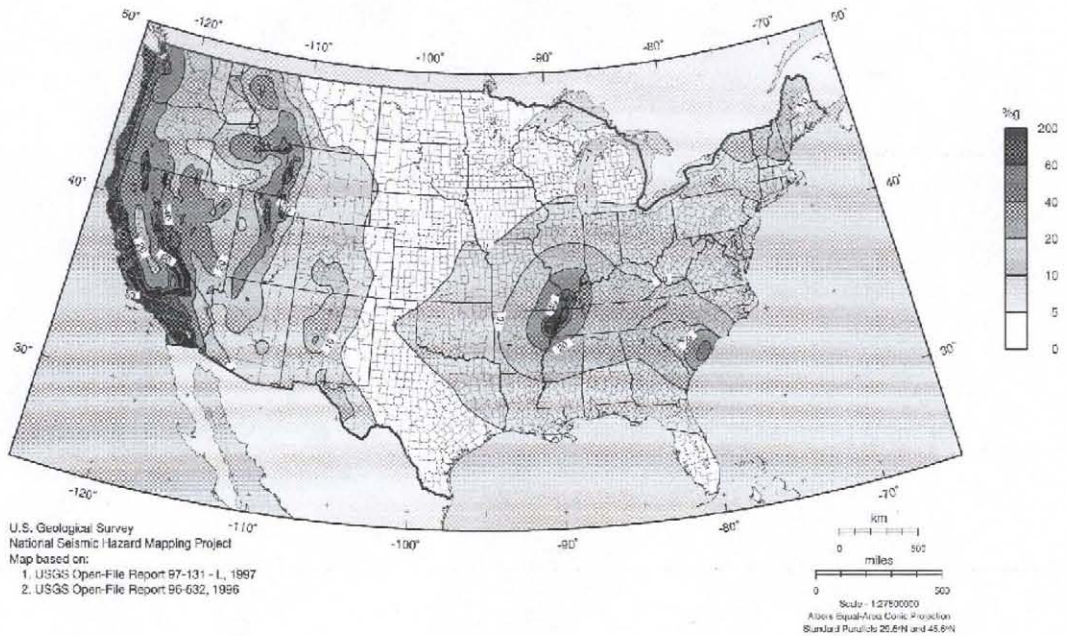

Figure B13 Probabilistic map of 1.0 sec spectral response acceleration with a 2% probability of exceedance in 50 years. The reference site material has a shear wave velocity of 750 m/sec.

DEVELOPMENT OF NEHRP MAXIMUM CONSIDERED EARTHQUAKE SPECTRAL ACCELERATION MAPS

The maximum considered earthquake spectral acceleration maps were derived from the 2 percent in 50 year probabilistic maps shown simplified as Figures B12 and B13 (also see Frankel et al, 1997), discussed above, with the application of the SDPG rules also described previously. Additional detail in applying the rules is described in this section. The 0.2 sec map is used for illustration purposes. The same procedures and similar comments apply for the 1.0 sec map.

One of the essential features of the SDPG rules was that the recommendations, when applied by others, would result in the same maps. This procedure allows the use of engineering judgment to be used in developing the maps, as long as those judgments are explicitly stated. This approach will simplify modification of the recommendations as knowledge improves.

It should be noted that although the maps are termed maximum considered earthquake ground motion maps. These maps are not for a single earthquake. The maps include probabilistic effects which consider all possible earthquakes up to the plateau level. Above the plateau level, the contours are included for the deterministic earthquake on each fault (unless the deterministic value is higher than the probabilistic values).

Deterministic contours. The deterministic contours, when included, are computed using the same attenuation functions used in the probabilistic analysis. However, the deterministic values are not used unless they are less than the probabilistic values. After study of those areas where the plateau was reached, the only areas where the deterministic values were less than the probabilistic values were located in California and along the subduction zone region of Washington and Oregon. Further study indicated that those areas with values in excess of the plateau were located in California. The appropriate attenuation for this area were the Boore-Joyner-Fumal attenuation (1993, 1994) and the Sadigh et al. (1993) attenuation.

The form of these attenuations and the distance measures used have an effect on the shape of these deterministic contours. Accordingly, they are discussed below. The Boore-Joyner-Fumal equation is:

$$\log Y = b_{ss}G_{ss} + b_{RS}G_{RS} + b_2(M - 6) + b_4r + b_5 \log(r) + b_6(\log V_s + \log V_a)$$

where:

Y	=	ground motion parameter
M	=	earthquake magnitude
b_{SS}, b_{RS}	=	coefficients for strike-slip and reverse-slip faults, determined by regression and different for each ground motion parameter
G_{SS}	=	1.0 for strike-slip fault, otherwise zero
G_{RS}	=	1.0 for reverse-slip fault, otherwise zero
b_2, b_3, b_4, b_5	=	coefficients determined by regression, different for each spectral acceleration
b_6	=	coefficient determined by regression, different for each spectral acceleration
V_A	=	coefficient determined by regression, different for each spectral acceleration
V_S	=	shear wave velocity for different site category
r	=	$(d^2 + h^2)^{1/2}$
d	=	closest horizontal distance from the site of interest to the surface projection of the rupture surface, see Figure B14
h	=	fictitious depth determined by regression, different for each ground motion parameter

Coefficients determined by regression are tabulated in the reports describing the attenuation equation.

The Sadigh et al. equation is:

$$\ln Y(T) = F \{ C_1 + C_2 M + C_3 (8.5 - M)^{2.5} + C_4 \ln [D + \exp(C_5 + C_6 M)] + C_7 \ln (D + 2) \}$$

where:

- Y = spectral response acceleration at period T
- M = earthquake magnitude
- $C_1, C_2, C_3 \dots C_7$ = coefficients determined by regression, different for each ground motion parameter
- D = closest distance to the fault rupture surface, see Figure B14
- F = Factor for fault type, 1.0 for strike-slip faults, 1.2 for reverse/thrust faulting, 1.09 for oblique faults

The distance measures are shown in Figure B14 and are discussed in more detail below.

The computation of spectral response (or any ground motion parameter) is a relatively simple matter for a specific site (or specific distance from a fault) but can become complex when preparing contours since it is difficult to calculate the specific distance at which a particular ground motion occurs. This is due to the complexity of the two attenuation functions and the need to combine their results. Since the attenuation functions were weighted equally, each contributes equally to the ground motion at a site. Deterministic contours were determined by preparing attenuation tables, that is the spectral response was computed at various distances from the fault or the fault ends for each earthquake magnitude. Contours for specific values were then drawn by selecting the table for the appropriate magnitude and determining, using interpolation, the distance from the fault for a given spectral acceleration. This procedure required, as a minimum, one attenuation table for each fault. Depending on the fault geometry, more than one table was needed. In order to illustrate this the strike-slip fault is discussed first, followed by a discussion of dipping faults.

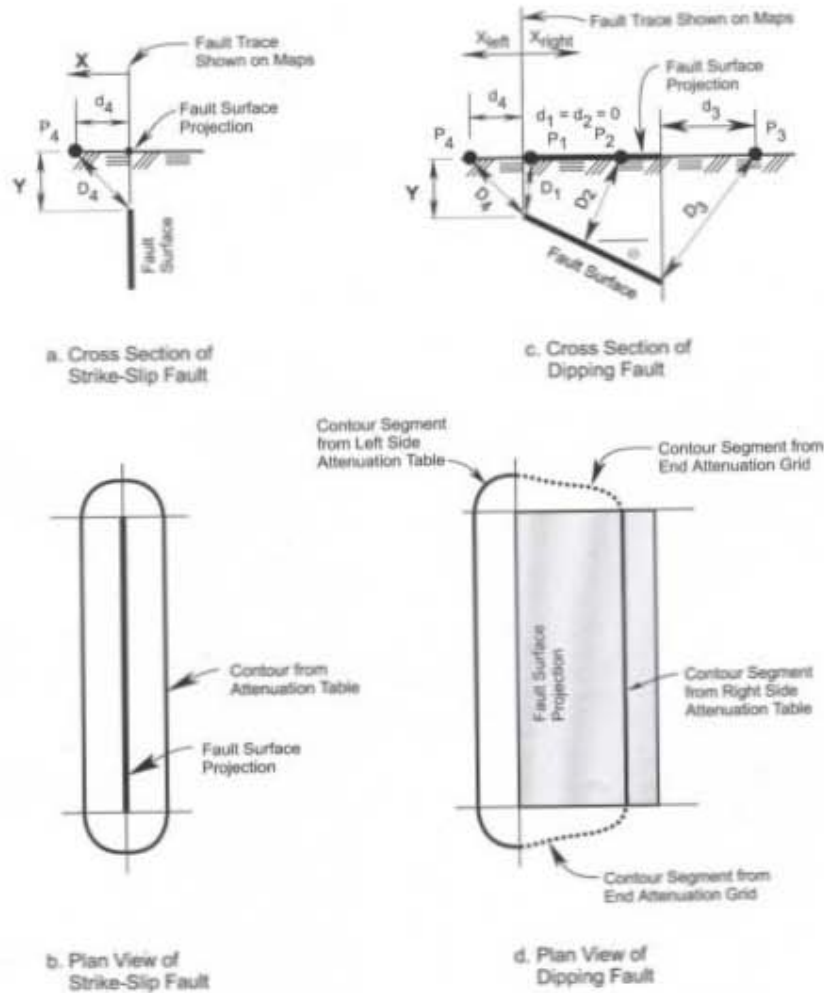

Figure B14 Measures of distance for strike-slip and dipping faults. A cross section of strike-slip fault is shown in figure (a) and the shape of a typical deterministic contour is shown in figure (b). A dipping fault is shown in figure (c) and the shape of a typical deterministic contour is shown in figure (d).

Strike-slip faults: The strike-slip fault, shown in Figure B14a, b is the simplest introduction to application of the SDPG rules. The distance measures are shown for each attenuation function in Figure B14a. The Boore-Joyner-Fumal equation uses the distance, d_4 . The term r in equation includes d_4 and the fictitious depth h . Since h is not zero, $r > d_4$, even if the term y in Figure B14a is zero. The Sadigh et al. equation measures the distance, D , as the closest distance to the rupture surface. In this case to the top of the rupture. If the depth y is zero, then $d_4 = D_4$.

It makes little difference in the computations if the fault rupture plane begins at the surface or at some distance below the surface. For the strike-slip fault the contour for a particular spectral acceleration is a constant distant from the fault and the contour is as shown in Figure B14b. One attenuation table (including the effects of both attenuation equations) can be used for either side of the fault and at the fault ends.

Dipping faults: The dipping fault, shown in Figures B14c and d, is the most complex case for preparing deterministic contours. The distance measures are shown for each attenuation function in Figure B14c. As before, it is a simple matter to compute the spectral values at a specific site, but not

as simple to compute the distance at which a specific spectral acceleration occurs. This is particularly true at the end of the fault.

On the left side of the fault shown in Figure B14c, an attenuation table is prepared, much as in the case of the strike-slip fault. This table may also be used to determine the contour around a portion of the fault end as shown in Figure B14d. In this case it is simply one-quarter of a circle.

A separate attenuation table must be prepared for the right side of the fault as shown in Figure B14d. Since d or D is measured differently, depending on location x , calculations must keep track of whether or not the location is inside or outside of the surface fault projection. Note that the term d is zero when the location x falls within the surface projection, but the fictitious depth h is not. Outside the fault projection, the distance d is measured from the edge of the projection. The distance D is calculated differently, as illustrated in Figure B14c, depending on location but it is always the closest distance to the fault rupture surface.

At the ends of the fault, an attenuation grid was prepared to determine the contour shape shown dotted in Figure B14d. The contour in this area was digitized using the gridded values and combined with the remainder of the contour determined from the left and right attenuation tables. This need for digitizing a portion of the contour greatly increased the time required to prepare each of the contours for dipping faults. In short, each dipping fault required two attenuation tables and an attenuation grid to prepare each deterministic contour. Thus preparation of each contour is far more time-consuming than preparing a contour for a strike-slip fault. Each contour is unsymmetrical around the fault, the amount of asymmetry depends on the angle of dip.

It can be argued that the knowledge of fault locations and geometry does not warrant this level of effort. However, it was considered necessary in order to follow the concept of repeatability in preparing the maps.

Combining deterministic contours: Where two or more faults are nearby, as in Figure B15a, the deterministic contours were merged (depending on amplitudes) as shown in Figure B15b. The merging resulted in the sharp “corners” shown in the figure. Although it can be argued that these intersections should be smoothed, it was believed that maintaining the shape reflected the decision to use deterministic contours.

Combining deterministic and probabilistic contours. The SDPG decision to use a combination of deterministic and probabilistic contours, although simple in principle, led to number of problems in preparing the contour maps.

Figure B16a, b for a single strike-slip fault illustrates the concept originally envisioned for combining the deterministic and probabilistic contours. After combining the two sets of contours shown in Figure B16a, the maximum considered earthquake contours would be as shown in Figure B16b.

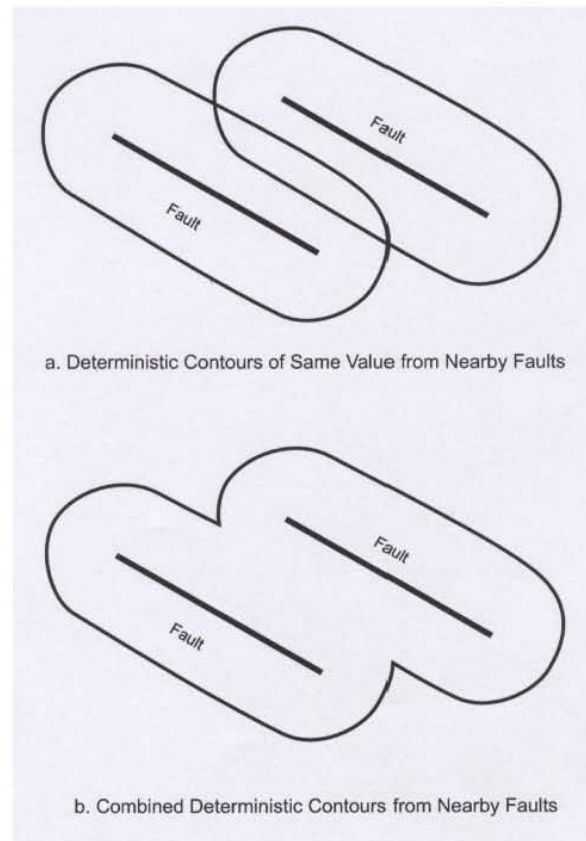

Figure B15 Procedure for combining deterministic contours from nearby faults

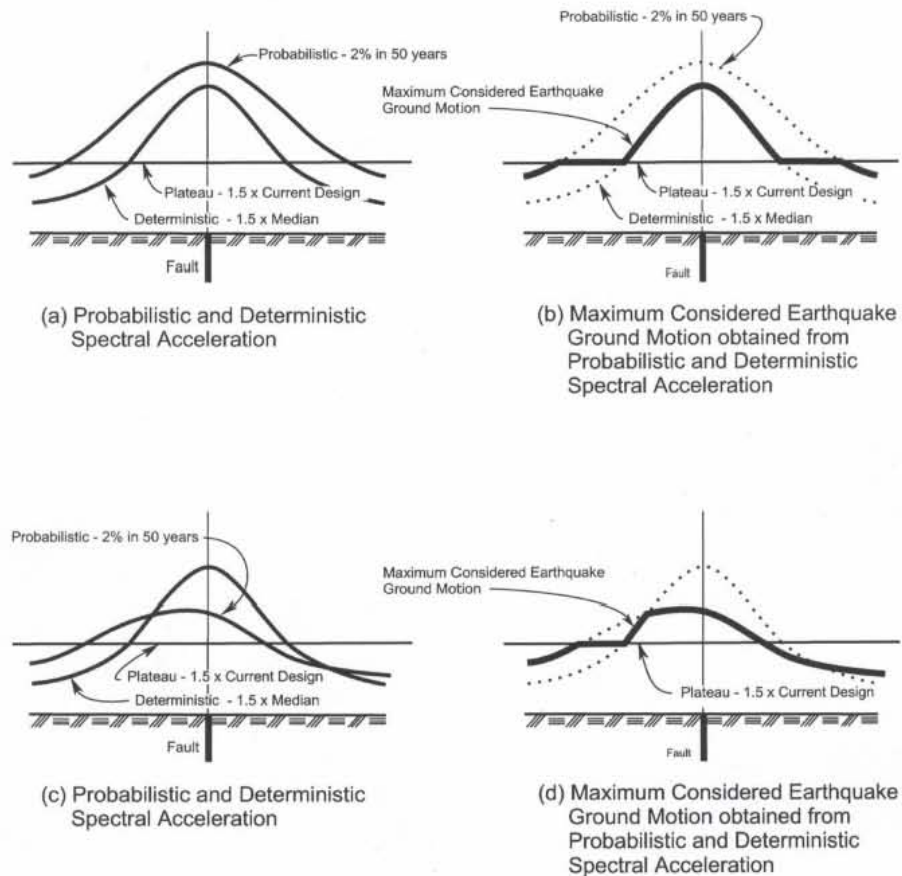

Figure B16 Procedure for obtaining maximum considered earthquake ground motion

In application the situation is more complex, there is frequently more than one fault, with different magnitudes, different return times, different fault geometry, and different locations with respect to each other. Examples are shown in Figures 17 and 18 which will be discussed later. The effect of the variables is illustrated in Figure B16 c and d. The deterministic curve is shown for a single fault with a return time much larger than that of the map. The deterministic spectral acceleration is much larger than the spectral acceleration resulting from historical seismicity. The probabilistic curve is not necessarily symmetrical to the fault. The resulting maximum considered earthquake curve shown in Figure B16d is a complex mix of the probabilistic and deterministic curves. There is not always a plateau and the curve is not necessarily symmetrical to the fault, even for a strike-slip fault. Simply stated, the probabilistic curve considers other sources such as historical seismicity and other faults as well as time. The deterministic curve does not consider other sources for this simple example and does not consider time.

The only areas of the United States that have deterministic contours are in California, along the Pacific coast through Oregon and Washington, and in Alaska. At first review it can be seen that there are several other areas that have contours in excess of the plateau but do not have plateaus. In these areas (e.g., New Madrid), the deterministic values exceed the probabilistic ones and thus were not used.

There were several instances where application of the SDPG rules produced results that appear counterintuitive and in other instance produced results that were edited. Two examples from southern

California are discussed below. Each example is illustrated with a three-part figure. Part (a) shows both probabilistic contours (dashed) and deterministic contours (solid) for each fault which is also shown. Part (b) shows the maximum considered earthquake results produced by following the SDPG rules. Part (c) shows how part (b) was edited for the final map.

Example 1: The first example in Figure B17 illustrates the occurrence of gaps in the deterministic contours around a fault and the halt of a deterministic contour before the end of a fault. When the probabilistic contours and deterministic contours shown in Figure B17a are combined, a gap in the deterministic contours occurs in the vicinity of 34.6° and 118.8° . Similarly the deterministic contours stop prior to the end of the fault around 34.65° and 119.4° . Both of these are shown in Figure B17b.

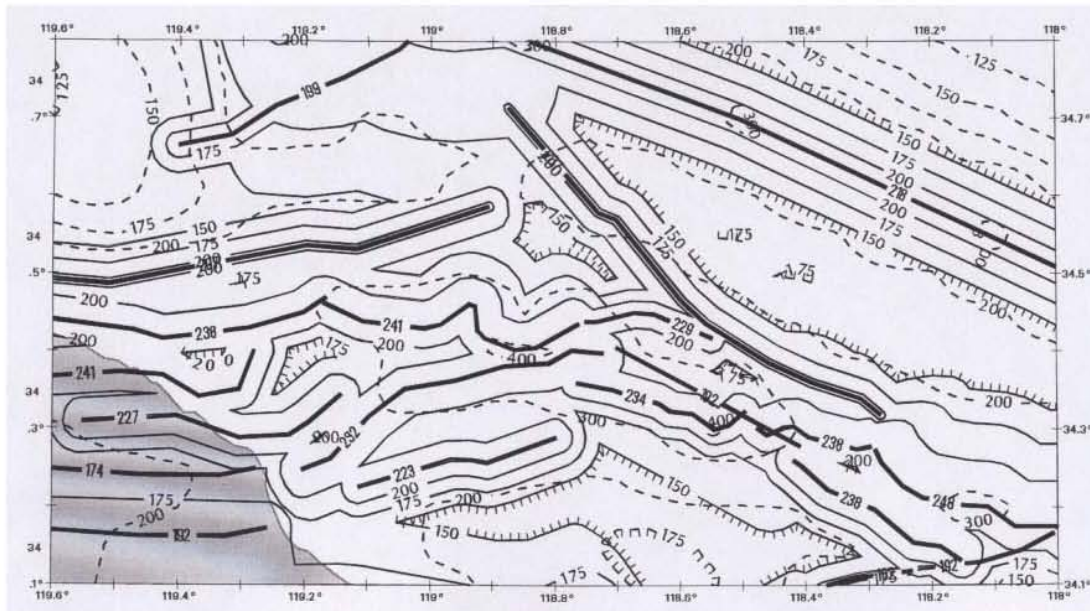

Figure B17a Combining contours - Example 1. Both probabilistic and deterministic contours are shown. Probabilistic contours are shown dashed.

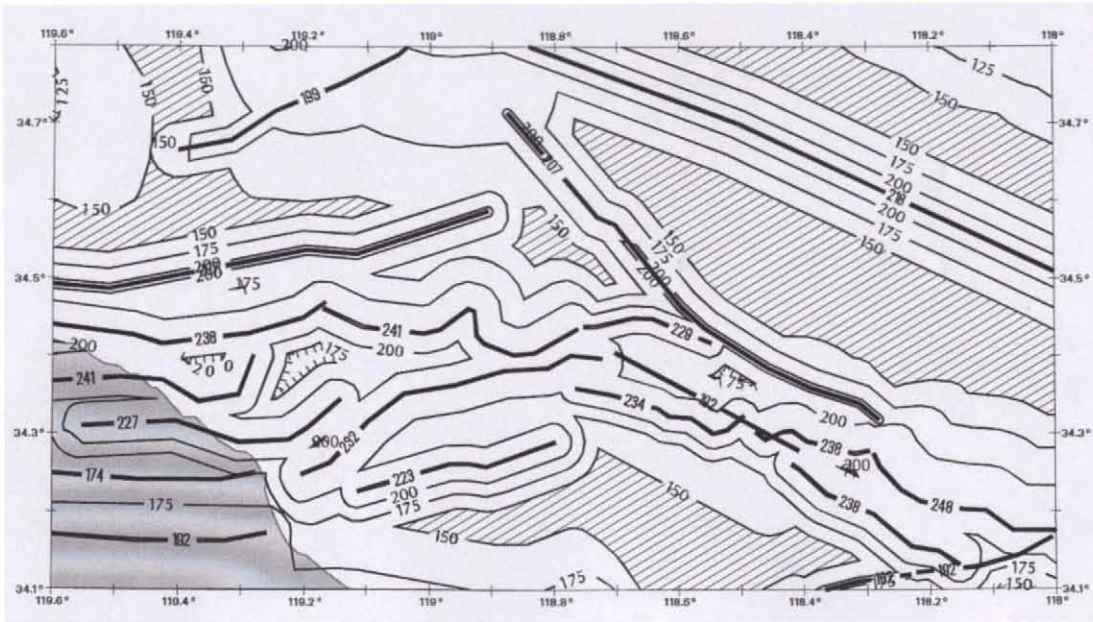

Figure B17b Combining contours - Example 1. Both probabilistic contours are merged using strict interpretation of committee rules.

After study, it is clear that the SDPG rules results in a repeatable, but unusual, set of contours. The result does not go along with the concept of accounting for near fault effects with the deterministic contours. Because of this undesirable effect, the contours were hand edited to restore the gaps and produce the result in Figure B17c.

All occurrences similar to this were edited to modify the contours so that the deterministic contours did not have abrupt breaks or stops before the ends of the fault.

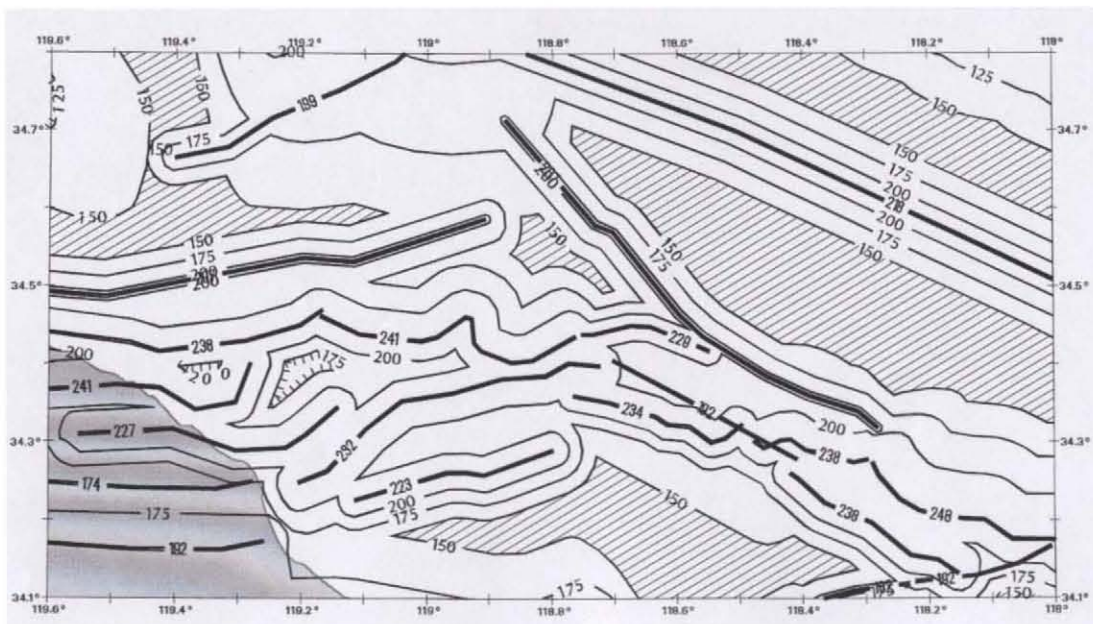

Figure B17c Combining contours - Example 1. Probabilistic contours are merged with deterministic contours using strict interpretation of committee rules with subsequent editing.

Example 2: The second example in Figure B18 illustrates the occurrence of many faults at different orientations to each other and with different return times. Merging of the complex set of contours is shown in Figure B18b. The contours are greatly simplified. Some small plateaus are shown along the 150 percent contour, as is a gap along one of the faults around 34.0° and 116.35°. The gap was edited as in example 1. The small plateaus were edited out using the judgment that their presence was inconsequential (less than a few percent effect on the maps) and unnecessarily complicated an already complicated map.

Another problem created was that some of the faults have portions of the fault, with a specific acceleration value, in areas where the contours are less than the fault value. An example occurs with the fault labeled 248 in the vicinity of 34.4° and 117.2°. A footnote was added to the maximum considered earthquake maps to the effect that the fault value was only to be used in areas where it exceeded the surrounding contours. Although other approaches are possible, such as showing the unused portion of the fault dashed, the full length of the faults are shown solid in the maps.

As shown in Figure B18b, a sawtooth contour around 34.15° and 116.3° results from application of committee rules. Although this appears to be a candidate for smoothing, it was not done as shown in Figure B18c. Once again there are several possible ways to smooth but it was not done in the interest of repeatability.

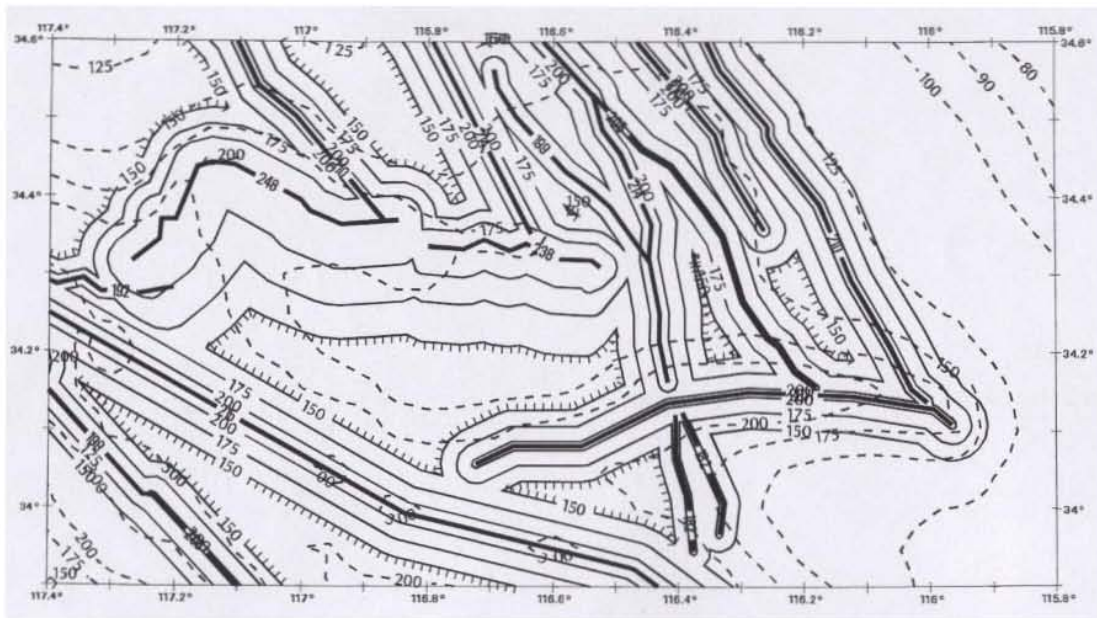

Figure B18a Combining contours - Example 2. Both probabilistic and deterministic contours are shown. Probabilistic contours are shown dotted.

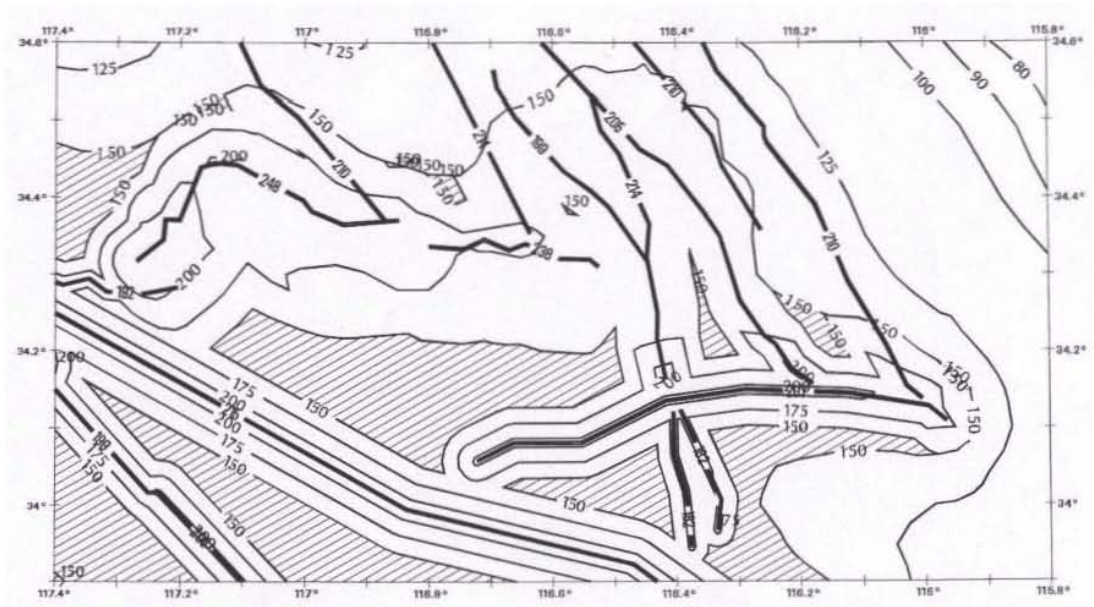

Figure B18b Combining contours - Example 2. Probabilistic contours are merged using strict interpretation of committee rules.

Probability level. The maximum considered earthquake spectral acceleration maps use the 2 percent in 50 maps as a base; however, the values obtained from the maps are multiplied by $2/3$ for use in the design equation. This implicitly results in a different probability being used in different areas of the United States. The hazard curves shown in Figure B2 are normalized to the 2 percent in 50 year value in Figure B19. This figure shows that the slope of the hazard curve varies in different areas of the United States. In general, the curves are steeper for CEUS cities than for WUS cities with the WUS curves beginning to flatten out earlier than the CEUS cities. Typical curves for a CEUS and WUS city are shown in Figure B20. This figure shows that when the $2/3$ factor is applied, probabilistic values for a WUS location are close to a 10 percent in 50 year value and probabilities for CEUS locations reflect a lower probability.

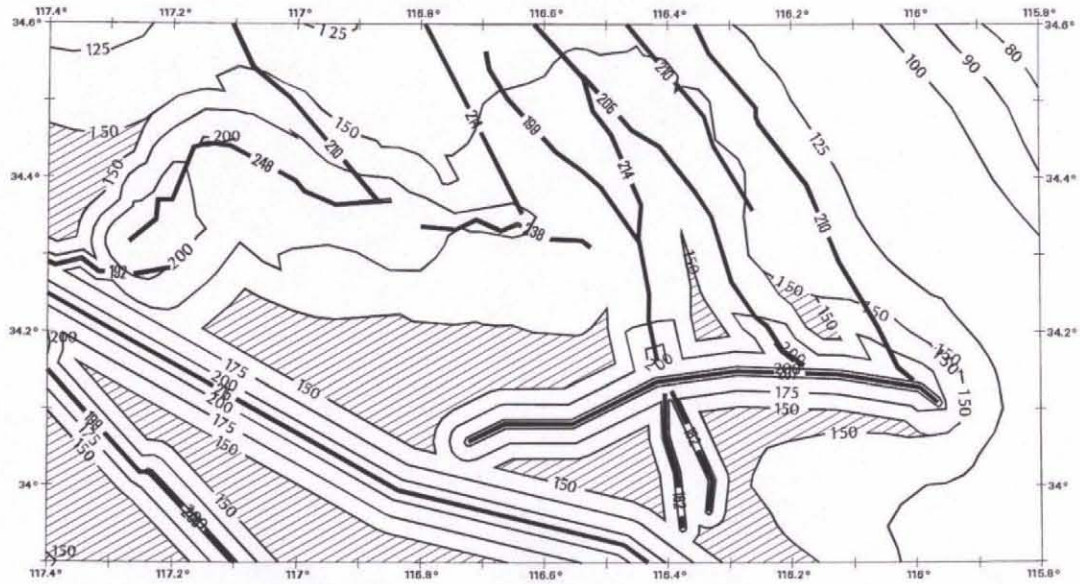

Figure B18c Combining contours - Example 2. Probabilistic contours are merged with deterministic contours using strict interpretation of committee rules with subsequent editing.

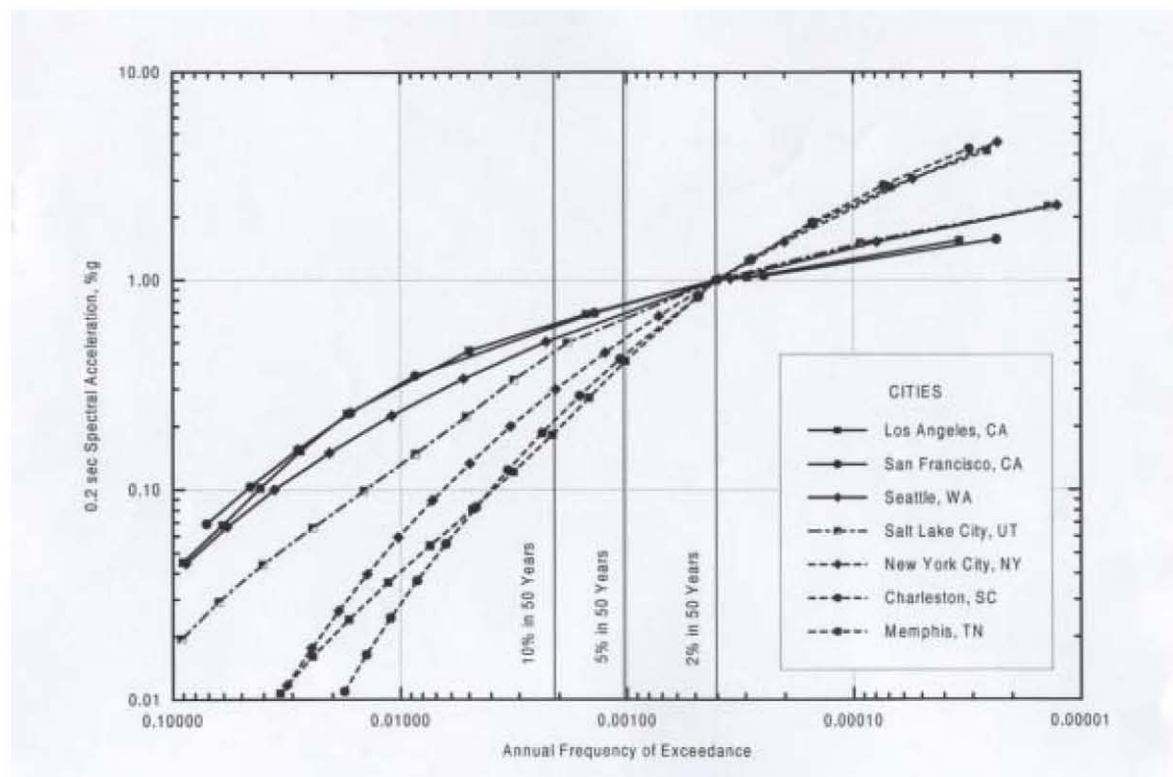

Figure B19 Hazard curves for selected cities. The curves are normalized to 2% in 50 years.

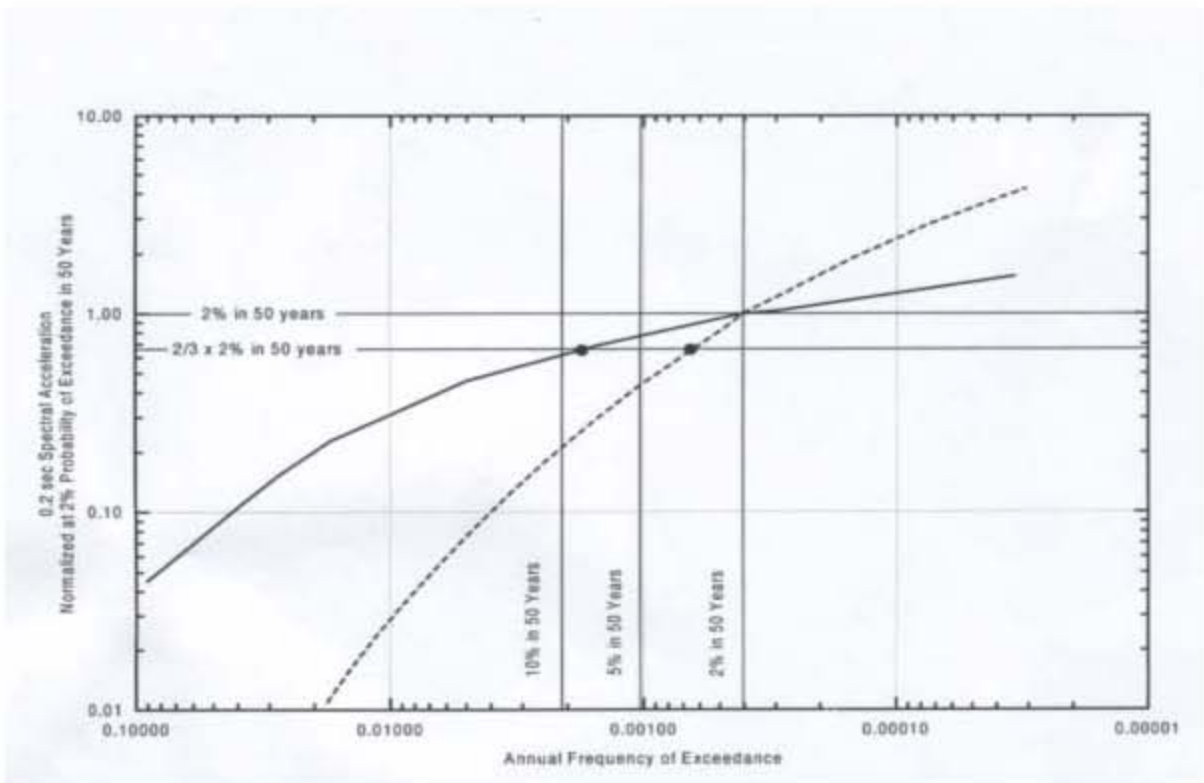

Figure B20 Effect on the probability level of multiplying the spectral acceleration by 2/3

Interpolation. Linear interpolation between contours is permitted using the maximum considered earthquake maps. To facilitate interpolation, spot values have been provided inside closed contours of increasing or decreasing values of the design parameter. Additional spot values have been provided where linear interpolation would be difficult. Values have also been provided along faults in the deterministic areas to aid in interpolation.

Hawaii. The Hawaii State Earthquake Advisory Board (HSEAB), in its ballot on the 1997 *Provisions*, proposed different maps from those included in the original BSSC ballot. The HSEAB's comments were based in part on recent work done to propose changes in seismic zonation for the 1994 and 1997 *Uniform Building Code*. The HSEAB also was concerned that in early 1998 the USGS would be completing maps that would be more up to date than those included in the original BSSC ballot. Essentially, the HSEAB's recommendation was that the maps it submitted or the new USGS maps should be used for Hawaii. The USGS maps were completed in March 1998 and were reviewed by the HSEAB, including proposals for incorporation of deterministic contours where the ground motions exceed the plateau levels described previously. The maps were revised in response to review comments and the modified design maps are included as part of the *Provisions*.

Briefly, the probabilistic maps were prepared using a USGS methodology similar to that used for the western United States (Klein et. al.). Two attenuation functions were used: Sadigh as described earlier and Munson and Thurber, which incorporates Hawaii data. The Hawaii contour maps (*Provisions* Map 10) are probabilistic except for two areas on the island of Hawaii. The two areas (outlined by the heavy border on Map 10) are located on the western and southeastern portion of the island. The two areas are defined by horizontal rupture planes at a 9 km depth. Within these zones, the spectral accelerations are constant. The western zone uses a magnitude 7.0 event while the southwestern zones uses a magnitude 8.2 event. The deterministic values inside the zone and for the contours were calculated as described in earlier sections.

Additional maximum considered earthquake ground motion maps. Maps for Puerto Rico and the U.S. Virgin islands were prepared using the USGS methodology described previously with modifications and attenuations appropriate for the region as described by Mueller, et. al. The two maximum considered earthquake spectral acceleration maps for the region are entirely probabilistic since values did not exceed the thresholds requiring incorporation of deterministic values. Although new probabilistic maps were not available for Guam and Tutuila, maximum considered earthquake maps were required for use by the *Provisions*. Maximum considered earthquake spectral response maps for these areas were prepared as follows.

Maps for Guam and Tutuila were prepared using the 1994 NEHRP maps. These were for approximately 10 percent probability of exceedance in 50 years. The ratio of PGA for 2 percent in 50 years to 10 percent in 50 years for the new USGS maps is about two. Accordingly maps for these areas were converted to 2 percent in 50 year maps by multiplying by two. These maps were then converted to spectral maps by using the factors described below.

A study of the ratios of the 0.2 sec and 1.0 sec spectral responses to PGA was done. Although approximate, the ratios were about 2.25 to 2.5 for the 0.2 sec spectral acceleration and about 1.0 for the 1.0 sec response. Thus PGA for the above regions was converted to spectral acceleration by multiplying PGA by 2.5 for the 0.2 sec response and by 1.0 for the 1.0 sec response. It should be noted that the multiplier for the 1.0 sec response varied over a wider range than the 0.2 sec response multiplier. It should be used cautiously.

REFERENCES

- Adams, J., D. H. Weichert, S. Halchuk, and P. W. Basham. 1996. Trial seismic hazard maps of Canada-1995: final values for selected Canadian cities, Geological Survey of Canada, Open File 3283.
- Algermissen, S. T., D. M. Perkins, P. C. Thenhaus, S. L. Hanson, and B. L. Bender. 1990. *Probabilistic Earthquake Acceleration and Velocity Maps for the United States and Puerto Rico*, U.S. Geological Survey, Miscellaneous Field Studies Map MF-2120.
- Algermissen, S. T., E. V. Leyendecker, G. A. Bollinger, N. C. Donovan, J. E. Ebel, W. B. Joyner, R. W. Luft, and J. P. Singh. 1991. "Probabilistic Ground-motion Hazard Maps of Response Spectral Ordinates for the United States," in *Proceedings of Fourth International Conference on Seismic Ordinates for the United States*, Stanford Univ., v. II, pp. 687-694.
- Amick, D., and R. Gelinas. 1991. "The Search for Evidence of Large Prehistoric Earthquakes along the Atlantic Seaboard," *Science*, v. 251, pp. 655-658.
- Atwater, B. F., and E. Hemphill-Haley. 1996. Preliminary estimates of recurrence intervals for great earthquakes of the past 3500 years at northeastern Willapa Bay, Washington, U.S. Geological Survey, Open-file report 96-001, 88pp.
- Atwater, B., A. Nelson, J. Clague, G. Carver, D. Yamaguchi, P. Bobrowsky, J. Bourgeois, M. Darienzo, W. Grant, S. Palmer, C. Peterson, and M. Reinhart. 1995. Summary of coastal geologic evidence for past great earthquakes at the Cascadia subduction zone, *Earthquake Spectra*, v. 11, pp.1-18.
- Black, B. D., W. R. Lund, and B. H. Mayes. 1995. Large earthquakes on the Salt Lake City segment of the Wasatch Fault Zone--summary of new information from the South Fork Dry Creek site, Salt Lake County, Utah, in *Environmental and Engineering Geology of the Wasatch Front Region*, W. R. Lund, ed., Utah Geological Association Publication 24, 1995.

- Boore, D. M., W. B. Joyner, and T. E. Fumal. 1993. Estimation of response spectra and peak accelerations from western North American earthquakes: an interim report, U.S. Geological Survey open-file report 93-509.
- Boore, D. M., W. B. Joyner, and T. E. Fumal. 1994a. Estimation of response spectra and peak accelerations from western North American earthquakes: an interim report Part 2, U.S. Geological Survey open-file report 94-127.
- Boore, D. M., W. B. Joyner, and T. E. Fumal. 1994b. Ground motion estimates for strike- and reverse-slip faults pre-print.
- Boore, D. M., W. B. Joyner, and T. E. Fumal. 1997. Equations for estimating horizontal response spectra and peak acceleration from western North American earthquakes: a summary of recent work, *Seismological Research Letters*, v. 68, no. 1, pp. 128-153.
- Chandler, V. W. 1995. The west-central Minnesota earthquake of June 5, 1993: an opportunity to re-examine seismicity near the Morris Fault, *Seism. Res. Let's*, v. 66, no. 6, pp. 113-121.
- Crone, A. J., and K. V. Luza. 1990. "Style and Timing of Holocene Surface Faulting on the Meers Fault, Southwestern Oklahoma," *Geological Society of America Bulletin*, v. 102, pp. 1-17.
- Crone, A., M. Machete, L. Bradley and S. Mahal. 1996. *Holocene Surface Faulting on the Cheraw Fault, Southeastern Colorado*, U.S. Geological Survey, MF map, in press.
- Crouse, C. B. 1991. Ground-motion attenuation equations for earthquakes on the Cascadia subduction zone, *Earthquake Spectra*, v. 7, p. 201.
- Doser, D. I. 1985. Source parameters and faulting processes of the 1959 Hebgen Lake, Montana, earthquake sequence, *J. Gaffes. Res.*, v. 90, pp. 4537-4556.
- Electric Power Research Institute. 1986. Seismic hazard methodology for the central and eastern United States, 10 volumes, EPRI report NP-4726, Electric Power Research Institute, Palo Alto.
- Edge, K. M., B. A. Scheol, and I. Po Lam. 1992. Development of seismic maps for Arizona, Arizona Dept. of Transportation, report no. FHA-AZ92-344.
- Frankel, A. 1995. "Mapping seismic hazard in the Central and Eastern United States," *Seismological Research Letters*, v. 66, no. 4, pp. 8-21.
- Frankel A., C. Mueller, T. Barnhard, D. Perkins, E. Leyendecker, N. Dickman, S. Hanson, and M. Hopper. 1996. *National Seismic Hazard Maps, June 1996: Documentation*, U.S. Geological Survey, Open-file Report 96-532.
- Frankel A., C. Mueller, T. Barnhard, D. Perkins, E. Leyendecker, N. Dickman, S. Hanson, and M. Hopper. 1997a. *Seismic - Hazard Maps for the Conterminous United States*: U.S. Geological Survey, Open-file Report 97-130, 12 sheets, scale 1:7,000,000.
- Frankel A., C. Mueller, T. Barnhard, D. Perkins, E. Leyendecker, N. Dickman, S. Hanson, and M. Hopper. 1997b. *Seismic - Hazard Maps for the California, Nevada and Western Arizona/Utah*: U.S. Geological Survey, Open-file Report 97-130, 12 sheets, scale 1:2,000,000.
- Geomatrix Consultants. 1993. Seismic margin earthquake for the Trojan site: final unpublished report prepared for Portland General Electric Trojan Nuclear Plant, Rainier, Oregon. Note: tables of these attenuation relationships are included in Geomatrix , 1995.
- Geomatrix Consultants. 1995. Seismic design mapping state of Oregon, Final Report prepared for Oregon Department of Transportation, Salem, Oregon.
- Goldfinger, C., L. D. Kulm, R. S. Yeats, B. Applegate, M. MacKay, and G. R. Cochrane in press. Active strike-slip faulting and folding of the Cascadia plate boundary and forearc in central and northern Oregon, in Rogers, A. M., W. J. Kockelman, G. Priest, and T. J. Walsh, eds., *Assessing and*

reducing earthquake hazards in the Pacific northwest, U.S. Geological Survey Professional Paper 1560.

Hyndman, R. D., and K. Wang. 1995. The rupture zone of Cascadia great earthquakes from current deformation and the thermal regime, *J. Gaffes. Res.*, v. 100, pp. 22,133-22,154.

Johnston, A. 1994. Moment magnitude assessment of stable continental earthquakes, Part I: instrumental seismicity, pre-print, published with revised relations in *Gaffes. J. Int.*, [1996], v. 124, pp. 381-414.

Johnston, A. 1996a. "Moment Magnitude Assessment of Stable Continental Earthquakes, Part 2: Historical Seismicity," *Gaffes. J. Int.*, v. 125, pp. 639-678.

Johnston, A. 1996b. "Seismic Moment Assessment of Stable Continental Earthquakes, Part 3: 1811-1812 New Madrid, 1886 Charleston, and 1755 Lisbon," submitted to *Gaffes. J. Int.*

Johnston, A. C., K. J. Coppersmith, L. R. Kanter, and C. A. Cornell. 1994. The earthquakes of stable continental regions: assessment of large earthquake potential, EPRI TR-102261, J. F. Schneider, ed., Electric Power Research Institute, 309 pp.

Johnston, A. C., and E. S. Schweig. 1996. The enigma of the New Madrid earthquakes of 1811-1812, *Annual Review of Earth and Planetary Sciences*, v. 24, pp. 339-384.

Joyner, W. B. 1995. Advocacy Paper #4, Soil is the most appropriate reference site condition, in ATC 35-2, Preprints: National Earthquake Ground Motion Mapping Workshop, Applied Technology Council.

Leyendecker, E. V., D. M. Perkins, S. T. Algermissen, P. C. Thenhaus, and S. L. Hanson. 1995. *USGS Spectral Response Maps and Their Relationship with Seismic Design Forces in Building Codes*, U.S. Geological Survey, Open-File Report 95-596.

Lienkaemper, J. J. 1996. "Fault parameter compilation for northern California," in preparation.

Martin, G. R., and R. Dobry. 1994. Earthquake site response and seismic code provisions, *NCEER Bulletin*, v. 8, pp. 1-6.

Mueller, C., M. Hopper, and A. Frankel. 1996. Preparation of earthquake catalogs for the 1996 national seismic hazard maps: documentation, U.S. Geological Survey Open-File Report, in review.

Mueller, C., M. A. Frankel, J. Lahr, and M. Wyss. 1997. Preparation of earthquake catalogs for the National Seismic Hazard Maps: Alaska, U.S. Geological Survey Open-File Report, in review.

Mueller, C., et. al., 2003, Seismic Hazard maps for Puerto Rico: U.S. Geological Survey Map I-abcd.

Mueller, C., et. al., 2003 Probabilistic Seismic Hazard maps of Puerto Rico: U.S. Geological Survey Open-File Report 03-xx,yy p.

Obermeier, S. F., R. B. Jacobson, J. P. Smoote, R. E. Weems, G. S. Gohn, J. E. Monroe, and D. S. Powers. 1990. "Earthquake-induced Liquefaction Features in the Coastal Setting of South Carolina and in the Fluvial Setting of the New Madrid Seismic Zone," U.S. Geological Survey, Prof. Paper 1504, 44 pp.

Obermeier, S. F., P. J. Munson, C. A. Munson, J. R. Martin, A. D. Frankel, T. L. Youd, and E. C. Pond. 1992. "Liquefaction Evidence for Strong Holocene Earthquakes in the Wabash Valley of Indiana-Illinois," *Seismological Research Letters*, v. 63, pp. 321-336.

Petersen, M. D., and S. G. Wesnousky. 1994. Fault slip rates and earthquake histories for active faults in southern California, *Bull. Seism. Soc. Am.*, v. 84, pp. 1608-1649.

Petersen, M. D., C. H. Cramer, W. A. Bryant, M. S. Reichle, and T. R. Topozada. 1996. Preliminary hazard assessment for Los Angeles, Ventura, and Orange counties, California, affected by the 17 January 1994 Northridge earthquake, *Bull. Seism. Soc. Am.*, v. 86, pp. S247-S261.

- Powell, C., G. Bollinger, M. Chapman, M. Sibol, A. Johnston, and R. Wheeler. 1994. A seismotectonic model for the 300-kilometer-long eastern Tennessee seismic zone, *Science*, v. 264, pp. 686-688.
- Sadigh, K., C. Y. Chang, N. A. Abrahamson, S. J. Chiou, and M. S. Power. 1993. Specification of long-period ground motions: updated attenuation relationships for rock site conditions and adjustment factors for near-fault effects, in Proceedings of ATC-17-1 Seminar on Seismic Isolation, Passive Energy Dissipation, and Active Control, Applied Technology Council, Redwood City. Note: tables of these attenuation relationships are included in Geomatrix, 1995.
- Sadigh, K., C. Y. Chang, J. Egan, F. Makdisi, and R. Youngs. 1997. Attenuation relationships for shallow crustal earthquakes based on California strong motion data, *Seismological Research Letters*, v. 68, no. 1, pp. 180-189.
- Satake, K., K. Shimazaki, Y. Tsuji, and K. Ueda. 1996. Time and size of a giant earthquake in Cascadia inferred from Japanese tsunami record of January 1700, *Nature*, v. 379, pp. 246-249.
- Schwartz, D. P., and K. J. Coppersmith. 1984. Fault behavior and characteristic earthquakes: examples from the Wasatch and San Andreas fault zones, *J. Gaffes. Res.*, v. 89, pp. 5681-5698.
- Seeber, L., and J. G. Armbruster. 1991. *The NCEER-91 Earthquake Catalog: Improved Intensity-based Magnitudes and Recurrence Relations for U.S. Earthquakes East of New Madrid*, National Center for Earthquake Engineering Research, NCEER-91-0021.
- Senior Seismic Hazard Analysis Committee. 1996?. *Probabilistic Seismic Hazard Analysis: a Consensus Methodology*, supported by DOE, NRC, and EPRI.
- Sibol, M. S., G. A. Bollinger, and J. B. Birch. 1987. "Estimation of Magnitudes in Central and Eastern North America Using Intensity and Felt Area," *Bulletin of the Seismological Society of America*, v. 77, pp. 1635-1654.
- Stover, C. W., and J. L. Coffman. 1993. "Seismicity of the United States 1568-1989, revised," *U.S. Geological Survey Professional Paper 1527*.
- Stover, C. W., G. Reagor, and S. T. Algermissen. 1984. *United States Earthquake Data File*, U.S. Geological Survey Open-File Report 84-225.
- Toro, G. R., N. A. Abrahamson, and J. F. Schneider. 1993. "Engineering Model of Strong Ground Motions from Earthquakes in the Central and Eastern United States," in *Guidelines for Determining Design Basis Ground Motions*, EPRI TR-102293, J. F. Schneider, ed., Electric Power Research Institute.
- U.S. Geological Survey National Seismic-Hazard Mapping Project, 1998a, *Alaska Seismic-Hazard Maps: Documentation*, U.S. Geological Survey, Open-file Report, in progress.
- U.S. Geological Survey National Seismic-Hazard Mapping Project, 1998b, *Seismic-Hazard Maps of Alaska*: U.S. Geological Survey, Open-file Report, 6 sheets, scale 1:5,000,000, in progress.
- Ward, S. N. 1994. A multidisciplinary approach to seismic hazard in southern California, *Bull. Seism. Soc. Am.*, v. 84, pp. 1293-1309.
- Weichert, D. H. 1980. Estimation of earthquake recurrence parameters for unequal observation periods for different magnitudes, *Bull. Seism. Soc. Am.*, 70, pp. 1337-1356.
- Wells, D. L., and K. J. Coppersmith. 1994. "New empirical relationships among magnitude, rupture length, rupture width, and surface displacement," *Bulletin of the Seismological Society of America*, v. 84, pp. 974-1002.
- Wesnousky, S. G. 1986. Earthquakes, Quaternary faults, and seismic hazard in California, *J. Gaffes. Res.*, v. 91, pp. 12,587-12,631.

Wheeler, R. L. 1995. "Earthquakes and the Cratonward Limit of Iapetan Faulting in Eastern North America," *Geology*, v. 23, pp. 105-108.

Working Group on California Earthquake Probabilities. 1995. Seismic hazards in southern California: probable earthquakes, 1994 to 2024, *Bull. Seism. Soc. Am.*, v. 85, pp. 379-439.

Wyman, R.V., M. Karakoujian, V. Bax-Valentine, D. B. Slemmons, L. Peterson, and S. Palmer. 1993. Geology of Las Vegas, Nevada, *Bull. Assoc. of Engineer. Geologists*, v. XXX, pp. 33-78.

Youngs, R., Chiou, W. Silva, and J. Humphrey. 1997. Strong ground motion attenuation relationships for subduction zone earthquakes, *Seismological Research Letters*, v. 68, no. 1, pp. 180-18.



THE COUNCIL: PROJECTS AND ACTIVITIES

The Building Seismic Safety Council (BSSC) was established in 1979 under the auspices of the National Institute of Building Sciences as an entirely new type of instrument for dealing with the complex regulatory, technical, social, and economic issues involved in developing and promulgating building earthquake risk mitigation regulatory provisions that are national in scope. By bringing together in the BSSC all of the needed expertise and all relevant public and private interests, it was believed that issues related to the seismic safety of the built environment could be resolved and jurisdictional problems overcome through authoritative guidance and assistance backed by a broad consensus.

The BSSC is an independent, voluntary membership body representing a wide variety of building community interests. Its fundamental purpose is to enhance public safety by providing a national forum that fosters improved seismic safety provisions for use by the building community in the planning, design, construction, regulation, and utilization of buildings. To fulfill its purpose, the BSSC:

- Promotes the development of seismic safety provisions suitable for use throughout the United States;
- Recommends, encourages, and promotes the adoption of appropriate seismic safety provisions in voluntary standards and model codes;
- Assesses progress in the implementation of such provisions by federal, state, and local regulatory and construction agencies;

- Identifies opportunities for improving seismic safety regulations and practices and encourages public and private organizations to effect such improvements;
- Promotes the development of training and educational courses and materials for use by design professionals, builders, building regulatory officials, elected officials, industry representatives, other members of the building community, and the public;
- Advises government bodies on their programs of research, development, and implementation; and
- Periodically reviews and evaluates research findings, practices, and experience and makes recommendations for incorporation into seismic design practices.

The BSSC's area of interest encompasses all building types, structures, and related facilities and includes explicit consideration and assessment of the social, technical, administrative, political, legal, and economic implications of its deliberations and recommendations. The BSSC believes that the achievement of its purpose is a concern shared by all in the public and private sectors; therefore, its activities are structured to provide all interested entities (i.e., government bodies at all levels, voluntary organizations, business, industry, the design profession, the construction industry, the research community, and the general public) with the opportunity to participate. The BSSC also believes that the regional and local differences in the nature and magnitude of potentially hazardous earthquake events require a flexible approach to seismic safety that allows for

consideration of the relative risk, resources, and capabilities of each community. The BSSC is committed to continued technical improvement of seismic design provisions, assessment of advances in engineering knowledge and design experience, and evaluation of earthquake impacts. It recognizes that appropriate earthquake hazard risk reduction measures and initiatives should be adopted by existing organizations and institutions and incorporated, whenever possible, into their legislation, regulations, practices, rules, codes, relief procedures, and loan requirements so that these measures and initiatives become an integral part of established activities, not additional burdens. Thus, the BSSC itself assumes no standards-making role; rather, it advocates that code- and standards-formulation organizations consider the BSSC's recommendations for inclusion in their documents and standards.

IMPROVING THE SEISMIC SAFETY OF NEW BUILDINGS

The BSSC program directed toward improving the seismic safety of new buildings has been conducted with funding from the Federal Emergency Management Agency (FEMA). It is structured to create and maintain authoritative, technically sound, up-to-date resource documents that can be used by the voluntary standards and model code organizations, the building community, the research community, and the public as the foundation for improved seismic safety design provisions.

The BSSC program began with initiatives taken by the National Science Foundation (NSF). Under an agreement with the National Institute of Standards and Technology (NIST; formerly the National Bureau of Standards), *Tentative Provisions for the Development of Seismic Regulations for Buildings* (referred to here as the *Tentative Provisions*) was prepared by the Applied Technology Council (ATC). The ATC document was described as the product of a "cooperative effort with the design professions, building code interests, and the research community" intended to

"...present, in one comprehensive document, the current state of knowledge in the fields of engineering seismology and engineering practice as it pertains to seismic design and construction of buildings." The document, however, included many innovations, and the ATC explained that a careful assessment was needed.

Following the issuance of the *Tentative Provisions* in 1978, NIST released a technical note calling for ". . . systematic analysis of the logic and internal consistency of [the *Tentative Provisions*]" and developed a plan for assessing and implementing seismic design provisions for buildings. This plan called for a thorough review of the *Tentative Provisions* by all interested organizations; the conduct of trial designs to establish the technical validity of the new provisions and to assess their economic impact; the establishment of a mechanism to encourage consideration and adoption of the new provisions by organizations promulgating national standards and model codes; and educational, technical, and administrative assistance to facilitate implementation and enforcement.

During this same period, other significant events occurred. In October 1977, Congress passed the *Earthquake Hazards Reduction Act of 1977* (P.L. 95-124) and, in June 1978, the National Earthquake Hazards Reduction Program (NEHRP) was created. Further, FEMA was established as an independent agency to coordinate all emergency management functions at the federal level. Thus, the future disposition of the *Tentative Provisions* and the 1978 NIST plan shifted to FEMA. The emergence of FEMA as the agency responsible for implementation of P.L. 95-124 (as amended) and the NEHRP also required the creation of a mechanism for obtaining broad public and private consensus on both recommended improved building design and construction regulatory provisions and the means to be used in their promulgation. Following a series of meetings between representatives of the original participants in the NSF-sponsored project on seismic design provisions, FEMA, the American Society of Civil Engineers and the National Institute of Building Sciences (NIBS), the concept of the Building Seismic Safety Council was born. As the concept began to take

form, progressively wider public and private participation was sought, culminating in a broadly representative organizing meeting in the spring of 1979, at which time a charter and organizational rules and procedures were thoroughly debated and agreed upon.

The BSSC provided the mechanism or forum needed to encourage consideration and adoption of the new provisions by the relevant organizations. A joint BSSC-NIST committee was formed to conduct the needed review of the *Tentative Provisions*, which resulted in 198 recommendations for changes. Another joint BSSC-NIST committee developed both the criteria by which the needed trial designs could be evaluated and the specific trial design program plan. Subsequently, a BSSC-NIST Trial Design Overview Committee was created to revise the trial design plan to accommodate a multiphased effort and to refine the *Tentative Provisions*, to the extent practicable, to reflect the recommendations generated during the earlier review.

Trial Designs

Initially, the BSSC trial design effort was to be conducted in two phases and was to include trial designs for 100 new buildings in 11 major cities, but financial limitations required that the program be scaled down. Ultimately, 17 design firms were retained to prepare trial designs for 46 new buildings in 4 cities with medium to high seismic risk (10 in Los Angeles, 4 in Seattle, 6 in Memphis, 6 in Phoenix) and in 5 cities with medium to low seismic risk (3 in Charleston, South Carolina, 4 in Chicago, 3 in Ft. Worth, 7 in New York, and 3 in St. Louis). Alternative designs for six of these buildings also were included.

The firms participating in the trial design program were: ABAM Engineers, Inc.; Alfred Benesch and Company; Allen and Hoshall; Bruce C. Olsen; Datum/Moore Partnership; Ellers, Oakley, Chester, and Rike, Inc.; Enwright Associates, Inc.; Johnson and Nielsen Associates; Klein and Hoffman, Inc.; Magadini-Alagia Associates; Read Jones Christoffersen, Inc.; Robertson, Fowler, and Associates; S. B. Barnes and Associates;

Skilling Ward Rogers Barkshire, Inc.; Theiss Engineers, Inc.; Weidlinger Associates; and Wheeler and Gray.

For each of the 52 designs, a set of general specifications was developed, but the responsible design engineering firms were given latitude to ensure that building design parameters were compatible with local construction practice. The designers were not permitted, however, to change the basic structural type even if an alternative structural type would have cost less than the specified type under the early version of the *Provisions*, and this constraint may have prevented some designers from selecting the most economical system.

Each building was designed twice – once according to the amended *Tentative Provisions* and again according to the prevailing local code for the particular location of the design. In this context, basic structural designs (complete enough to assess the cost of the structural portion of the building), partial structural designs (special studies to test specific parameters, provisions, or objectives), partial nonstructural designs (complete enough to assess the cost of the nonstructural portion of the building), and design/construction cost estimates were developed.

This phase of the BSSC program concluded with publication of a draft version of the recommended provisions, the *NEHRP Recommended Provisions for the Development of Seismic Regulations for New Buildings*, an overview of the *Provisions* refinement and trial design efforts, and the design firms' reports.

The 1985 Edition of the NEHRP Recommended Provisions

The draft version represented an interim set of provisions pending their balloting by the BSSC member organizations. The first ballot, conducted in accordance with the BSSC Charter, was organized on a chapter-by-chapter basis. As required by BSSC procedures, the ballot provided for four responses: "yes," "yes with reservations," "no," and "abstain." All "yes with reservations" and "no" votes were to be

accompanied by an explanation of the reasons for the vote and the "no" votes were to be accompanied by specific suggestions for change if those changes would change the negative vote to an affirmative.

All comments and explanations received with "yes with reservations" and "no" votes were compiled, and proposals for dealing with them were developed for consideration by the Technical Overview Committee and, subsequently, the BSSC Board of Direction. The draft provisions then were revised to reflect the changes deemed appropriate by the BSSC Board and the revision was submitted to the BSSC membership for balloting again. As a result of this second ballot, virtually the entire provisions document received consensus approval, and a special BSSC Council meeting was held in November 1985 to resolve as many of the remaining issues as possible. The 1985 Edition of the *NEHRP Recommended Provisions* then was transmitted to FEMA for publication in December 1985.

During the next three years, a number of documents were published to support and complement the 1985 *Provisions*. They included a guide to application of the *Provisions* in earthquake-resistant building design, a nontechnical explanation of the *Provisions* for the lay reader, and a handbook for interested members of the building community and others explaining the societal implications of utilizing improved seismic safety provisions and a companion volume of selected readings.

The 1988 Edition

The need for continuing revision of the *Provisions* had been anticipated since the onset of the BSSC program and the effort to update the 1985 Edition for reissuance in 1988 began in January 1986. During the update effort, nine BSSC Technical Committees (TCs) studied issues concerning seismic risk maps, structural design, foundations, concrete, masonry, steel, wood, architectural and mechanical and electrical systems, and regulatory use. The Technical Committees

worked under the general direction of a Technical Management Committee (TMC), which was composed of a representative of each TC as well as additional members identified by the BSSC Board to provide balance.

The TCs and TMC worked throughout 1987 to develop specific proposals for changes needed in the 1985 *Provisions*. In December 1987, the Board reviewed these proposals and decided upon a set of 53 for submittal to the BSSC membership for ballot. Approximately half of the proposals reflected new issues while the other half reflected efforts to deal with unresolved 1985 edition issues.

The balloting was conducted on a proposal-by-proposal basis in February-April 1988. Fifty of the proposals on the ballot passed and three failed. All comments and "yes with reservation" and "no" votes received as a result of the ballot were compiled for review by the TMC. Many of the comments could be addressed by making minor editorial adjustments and these were approved by the BSSC Board. Other comments were found to be unpersuasive or in need of further study during the next update cycle (to prepare the 1991 *Provisions*). A number of comments persuaded the TMC and Board that a substantial alteration of some balloted proposals was necessary, and it was decided to submit these matters (11 in all) to the BSSC membership for rebalot during June-July 1988. Nine of the eleven rebalot proposals passed and two failed.

On the basis of the ballot and rebalot results, the 1988 *Provisions* documents were prepared and transmitted to FEMA for publication in August 1988. A report describing the changes made in the 1985 edition and issues in need of attention in the next update cycle also was prepared, and efforts to update the complementary reports published to support the 1985 edition were initiated. Ultimately, the following publications were updated to reflect the 1988 Edition and reissued by FEMA: the *Guide to Application of the Provisions*, the handbook discussing societal implications (which was extensively revised and retitled *Seismic Considerations for Communities at Risk*), and several *Seismic Considerations* handbooks (which are described below).

The 1991 Edition

During the effort to produce the 1991 *Provisions*, a Provisions Update Committee (PUC) and 11 Technical Subcommittees (TSs) addressed seismic hazard maps, structural design criteria and analysis, foundations, cast-in-place and precast concrete structures, masonry structures, steel structures, wood structures, mechanical-electrical systems and building equipment and architectural elements, quality assurance, interface with codes and standards, and composite structures. Their work resulted in 58 substantive and 45 editorial proposals for change to the 1988 *Provisions*.

The PUC, under the leadership of Loring Wyllie of Degenkolb Enginners, approved more than 90 percent of the proposals and, in January 1991, the BSSC Board accepted the PUC-approved proposals for balloting by the BSSC member organizations in April-May 1991.

Following the balloting, the PUC considered the comments received with "yes with reservations" and "no" votes and prepared 21 rebalot proposals for consideration by the BSSC member organizations. The rebaloting was completed in August 1991 with the approval by the BSSC member organizations of 19 of the rebalot proposals.

On the basis of the ballot and rebalot results, the 1991 *Provisions* documents were prepared and transmitted to FEMA for publication in September 1991. Reports describing the changes made in the 1988 Edition and issues in need of attention in the next update cycle also were developed.

In August 1992, in response to a request from FEMA, the BSSC initiated an effort to continue its structured information dissemination and instruction/training effort aimed at stimulating widespread use of the *Provisions*. The primary objectives of the effort were to bring several of the publications complementing the *Provisions* into conformance with the 1991 Edition in a

manner reflecting other related developments (e.g., the fact that all three model codes now include requirements based on the *Provisions*) and to bring instructional course materials currently being used in the BSSC seminar series (described below) into conformance with the 1991 *Provisions*.

The 1994 Edition

The effort to structure the 1994 PUC and its technical subcommittees was initiated in late 1991 chairing the OUC again for this cycle was Loring Wyllie. By early 1992, 12 Technical Subcommittees were established to address seismic hazard mapping, loads and analysis criteria, foundations and geotechnical considerations, cast-in-place and precast concrete structures, masonry structures, steel structures, wood structures, mechanical-electrical systems and building equipment and architectural elements, quality assurance, interface with codes and standards, and composite steel and concrete structures, and base isolation/energy dissipation.

The TSs worked throughout 1992 and 1993 and, at a December 1994 meeting, the PUC voted to forward 52 proposals to the BSSC Board with its recommendation that they be submitted to the BSSC member organizations for balloting. Three proposals not approved by the PUC also were forwarded to the Board because 20 percent of the PUC members present at the meeting voted to do so. Subsequently, an additional proposal to address needed terminology changes also was developed and forwarded to the Board.

The Board subsequently accepted the PUC-approved proposals; it also accepted one of the proposals submitted under the "20 percent" rule but revised the proposal to be balloted as four separate items. The BSSC member organization balloting of the resulting 57 proposals occurred in March-May 1994, with 42 of the 54 voting member organizations submitting their ballots. Fifty-three of the proposals passed, and the ballot results and comments were reviewed by the PUC in July 1994. Twenty substantive changes that would require rebaloting were identified. Of the four proposals that failed the ballot, three were withdrawn by the TS chairmen and one was

substantially modified and also was accepted for reballoting. The BSSC Board of Direction accepted the PUC recommendations except in one case where it deemed comments to be persuasive and made an additional substantive change to be reballoted by the BSSC member organizations.

The second ballot package composed of 22 changes was considered by the BSSC member organizations in September-October 1994. The PUC then assessed the second ballot results and made its recommendations to the BSSC Board in November. One needed revision identified later was considered by the PUC Executive Committee in December. The final copy of the 1994 Edition of the *Provisions* including a summary of the differences between the 1991 and 1994 Editions was delivered to FEMA in March 1995.

The 1997 Edition

In September 1994, NIBS entered into a contract with FEMA for initiation of the 39-month BSSC 1997 *Provisions* update effort. Late in 1994, the BSSC member organization representatives and alternate representatives and the BSSC Board of Direction were asked to identify individuals to serve on the 1997 PUC and its TSs. The 1997 PUC, chaired by Bill Holmes of Rutherford and Chekene, was constituted early in 1995, and 12 PUC Technical Subcommittees were established to address design criteria and analysis, foundations and geotechnical considerations, cast-in-place/precast concrete structures, masonry structures, steel structures, wood structures, mechanical-electrical systems and building equipment and architectural elements, quality assurance, interface with codes and standards, composite steel and concrete structures, energy dissipation and base isolation, and nonbuilding structures.

As part of this effort, the BSSC developed for the 1997 *Provisions* a revised seismic design procedure. Unlike the design procedure based on U.S. Geological Survey (USGS) peak acceleration and peak velocity-related

acceleration ground motion maps developed in the 1970s and used in earlier editions of the *Provisions*, the new design procedure involves new design maps based on recently revised USGS spectral response maps and a process specified within the body of the *Provisions*. This task was conducted with the cooperation of the USGS (under a Memorandum of Understanding signed by the BSSC and USGS) by the Seismic Design Procedure Group (SDPG) working with the guidance of a five-member Management Committee.

More than 200 individuals participated in the 1997 update effort, and more than 165 substantive proposals for change were developed. A series of editorial/organizational changes also were made. All draft TS, SDPG, and PUC proposals for change were finalized in late February 1997, and in early March, the PUC Chair presented to the BSSC Board of Direction the PUC's recommendations concerning proposals for change to be submitted to the BSSC member organizations for balloting. The Board accepted these recommendations, and the first round of balloting was conducted in April-June 1997.

Of the 158 items on the first ballot, only 8 did not pass; however, many comments were submitted with "no" and "yes with reservations" votes. These comments were compiled for distribution to the PUC, which met in mid-July to review the comments, receive TS responses to the comments and recommendations for change, and formulate its recommendations concerning what items should be submitted to the BSSC member organizations for a second ballot. The PUC deliberations resulted in the decision to recommend to the BSSC Board that 28 items be included in the second ballot. The PUC Chair subsequently presented the PUC's recommendations to the Board, which accepted those recommendations.

The second round of balloting was completed in October. All but one proposal passed; however, a number of comments on virtually all the proposals were submitted with the ballots and were immediately compiled for consideration by the PUC. The PUC Executive Committee met in

December to formulate its recommendations to the Board, and the Board subsequently accepted those recommendations.

The PUC concluded its update work by identifying issues in need of consideration during the next update cycle and technical issues in need of study. The final version of the 1997 *Provisions*, including an appendix describing the differences between the 1994 and 1997 edition, was transmitted to FEMA in February 1998. The contract for the 1997 update effort was extended by FEMA to September 1999 to permit several complementary initiatives to be pursued.

One of these initiatives resulted in a CD that provides all of the design mapping data needed for use with the 1997 *NEHRP Recommended Provisions* and *International Building Code* as well as the *International Residential Code* and the *NEHRP Guidelines for the Seismic Rehabilitation of Buildings*. This CD was developed for the BSSC by Dr. E. V. Leyendecker of the U.S. Geological Survey. It permits the user to search either by longitude and latitude or by zipcode. Although the CD-ROM is distributed by FEMA and the BSSC, the International Code Council was given permission to reproduce copies to accompany the *International Building Code* (IBC) and *International Residential Code* (IRC).

The second initiative resulted in a list of the relevant seismic design map data on a county-by-county basis. One listing identifies populated places, state, county, population (when available), latitude and longitude, two maximum considered earthquake (MCE) spectral points (for use with the 1997 *NEHRP Recommended Provisions*, *International Building Code*: two spectral points for the 10 percent probability in 50 year maps (for use with the *NEHRP Guidelines for the Seismic Rehabilitation of Buildings*), and the corresponding category for use with the *International Residential Code*. The final version of this listing can be sorted alphabetically by county and then by place in the county. Another listing presents the counties for each state and provides the same

information as in the first listing but uses the approximate geographic or “centroid” coordinates to determine the data grid values for each county as a whole. These listings are based on the USGA developed CD and were assembled for the BSSC by Richard McConnell.

In a somewhat related effort, the BSSC commissioned a set of approximately 40 comparative designs. Each comparative design was performed at least three times: once according to the proposed 2000 *IBC* (which is being take to represent the 1997 *NEHRP Recommended Provisions*), once according to the 1991 *Provisions* (requirements reflected in the *National Building Code* and *Standard Building Code*), and once according to the 1994 *Uniform Building Code*. Performing the study for the BSSC were the J. R. Harris and Company and S. K. Ghosh Associates, Inc.

Also developed during this update cycle was the BSSC website ----www.bssconline.org . The site provides BSSC with a means for posting proposals for changes and other information for public comment and also is a venue for a host of downloadable material including the *Provisions* and *Commentary*.

The 2000 Edition

In September 1997, NIBS entered into a contract with FEMA for initiation of the 48-month BSSC effort to update the 1997 *NEHRP Recommended Provisions for Seismic Regulations for New Buildings and Other Structures*.

In lieu of the Seismic Design Procedure Group (SDPG) used in the 1997 update, the BSSC re-established Technical Subcommittee 1, Seismic Design Mapping, used in earlier updates of the *Provisions*. This subcommittee is composed of an equal number of representatives from the earth science community, including representatives from the USGS, and the engineering community.

An additional 11 subcommittees were formed to address seismic design and analysis, foundations and geotechnical considerations, cast-in-place and precast concrete structures, masonry structures, steel structures, wood structures,

mechanical-electrical systems and building equipment and architectural elements, quality assurance, composite steel and concrete structures, base isolation and energy dissipation, and nonbuilding structures. Two ad hoc task groups also were formed: one to develop appropriate anchorage requirements for concrete/masonry/wood elements and the other to develop a simplified procedure for use in the lower seismic risk areas. No technical subcommittee was established in this update cycle to serve specifically as the interface with codes and standards; rather, the BSSC's Code Resource Support Committee provided for the needed liaison between the PUC and the model code and standards organizations.

The first ballot encompassing 146 proposals for change to the 1997 *Provisions* was submitted to the BSSC member organizations in April, 2000; the ballot deadline in June. The proposals for change also were posted for comment on the BSSC website. Of the 64 member organizations who received ballot packages, 42 responded. Of the 146 proposals, 69 passed with no "no" votes but some "yes with reservations" votes, 71 passed but with "no" and "yes with reservations" votes, and 6 did not pass (i.e., received less than 67 percent "yes" and "yes with reservations" votes). The comments submitted with "no" and "yes with reservations" votes were compiled and distributed to the PUC Technical Subcommittee chairs. The PUC then met in Denver in July 2000 to receive the TSS responses to ballot comments and formulate recommendations concerning items that need to be submitted to the member organizations for a second ballot

In August 2000, PUC Chair William Holmes briefed the BSSC Board of Direction on the results of the first ballot and recommended that 17 items be submitted to the membership for a second ballot. Ten of the proposals were revisions of previous proposals, three were new proposals, and four were proposals developed by the PUC to clarify concerns arising from the first ballot.

The official second ballot package was mailed to BSSC member organizations for voting in September- October 2000. Of the 66 BSSC member organizations, 42 responded and all proposals passed. There were, however, several "yes with reservations" and "no" votes, and the PUC met on October 30-31, 2000, to resolve the comments submitted with these votes and to formulate recommendations concerning a third ballot.

On November 1, 2000, the PUC chair presented the second ballot results to the BSSC Board and recommended that several items be submitted to the membership for a third ballot. The primary purpose of the third ballot was to permit integration into the 2000 *Provisions* of new steel requirements resulting from the FEMA-funded SAC effort mounted to study damage during the Northridge earthquake and of the most current version of the American Institute of Steel Construction standard which was expected to include many of the SAC requirements. The third ballot, which included five proposals, was sent to the membership for vote by February 2001. Of the 65 member organizations, 44 submitted ballots (67 percent). All five proposals passed and the results were reviewed and comments resolved by the PUC Executive Committee at a meeting in March 2001.

The PUC chair briefed the BSSC Board on the third ballot results on March 6, 2000, and the Board unanimously approved the 2000 *Provisions* for transmittal to FEMA following a final editorial review by the PUC of the *Provisions* document and its accompanying *Commentary* volume. Reports identifying the major differences between the 1997 and the 2000 Editions of the *Provisions* and describing unresolved issues and major technical topics in need of further study also were prepared. Code-language versions of changes for the 2000 *Provisions* for submittal as proposed code changes for the 2003 Edition of the *IBC* were developed for the BSSC by S. K. Ghosh Associates.

The 2003 Edition

Well before the actual contract between FEMA and the BSSC was awarded, planning for the 2003 Edition was under way. Several major where the initial topics of attention. First, in January 2001 a meeting was held to decide how best to handle the diverse subject of nonbuilding structures. It was concluded that the best solution for the 2003 cycle was to recommend that the nonbuilding structures technical subcommittee (T S 13) continue but have greater representation on the PUC with four members. It was also recommended that TS 13 form eight subgroups to address major nonbuilding structures categories such as chimneys, wharves and piers, tanks and vessels, etc.

The second area of concern was a detailed edit of the 2000 provisions to eliminate the undue repetition and inconsistencies that had crept in over the years. This edit performed at the end of the 2000 cycle by Michael valley of Magnusson and Klemencic. After a thorough review of the edited document, this "Reformatted" version was voted on by the BSSC membership in October 2001. It was accepted and became the basis for the 2003 update.

The final issue involved structuring the 2003 update to reflect the fact that the *Provisions* requirements were being reflected in ASCE 7, the IBC, the IRC, and the NFPA 5000. Further it seemed likely that the I codes would cover most seismic matters by referencing the ASCE 7. Thus it appeared most reasonable to coordinate the BSSC efforts with those of ASCE 7 Seismic Task Committee, there by relieving the PUC and its TSs of the responsibility for maintaining code language. Considerable progress has been made on integrating ASCE 7 as a full reference standard during the 2003 update cycle and it is expected that this effort will be completed during the next update.

The proposal for the 2003 update of the NEHRP Recommended Provisions was submitted to FEMA in June 2001. In order to

keep the momentum of the update process and with the concurrence of the FEMA Project Officer, candidates for update committee membership were identified and recommended membership lists were reviewed and accepted by the BSSC Board at a June 2001 meeting along with a revised procedures/goals statement for the effort developed to reflect the thoughts expressed at the BSSC Annual Meeting in March. Letters of invitation to serve on the update committees were mailed in late June 2001.

The 2003 Provisions Update Committee (PUC) convened for the first time in July in conjunction with a meeting of the Joint Correlating Committee, which was established for the 2003 update cycle to eliminate duplication of efforts by those working on the Provisions and those working on ASCE 7. The PUC Technical Subcommittee (TS) chairs identified topics they intended to consider during the update and a tentative schedule for the project was established.

FEMA signed the contract with NIBS for the 2003 update project on September 28, 2001. This 30-month contract provides for conduct of a base series of tasks and two options.

A comprehensive edit of the 2000 *Provisions* initiated in early 2000 to eliminate undue repetition and inconsistencies and generally make the document more user-friendly was completed in late summer and reviewed by the PUC. After revisions to reflect PUC member comments, the draft reformatted document was accepted by the BSSC Board for balloting by the BSSC member organizations to determine whether the revised draft could be used as the base document for the remainder of the 2003 update effort. The balloting occurred between October and December 2001. Forty of the 65 BSSC member organizations submitted ballots on the reformatted Provisions and the document was approved; however, a number of significant comments accompanied the ballots. These comments were compiled and responses formulated. In January 2002, the PUC debated resolution of the comments and submitted its recommendations to the BSSC Board, which accepted the PUC recommendations and approved use of the reformatted 2000 Provisions

as the base document for the remainder of the 2003 update effort.

Work also began in early 2002 on development of the new BSSC website that is expected to permit Technical Subcommittee and PUC members to develop, review, and vote on proposals in an interactive electronic environment and that also will permit the BSSC member organizations to receive proposals and submit their ballots electronically.

Proposals for change to be submitted to the PUC for ballot were submitted in late August 2002 and were mailed to the PUC for balloting on September 11, 2002. Completed ballots were due in mid-October, and the results were compiled for review/response by the relevant Technical Subcommittee in preparation for review by the full PUC. The PUC then met in Washington, D.C., on November 7-8 and formulated its recommendations for the BSSC Board concerning proposals to be submitted to the BSSC member organizations for ballot. Of the 77 proposals initially submitted by its technical subcommittees, the PUC recommended to the Board that 54 proposals be submitted to the BSSC member organizations for ballot but that this balloting not occur until all proposals for change for the 2003 Provisions are completed. The Board accepted this recommendation, and remaining proposals were scheduled to be submitted for PUC review by April 1, 2003.

Approximately 90 proposals were submitted for a mail ballot by the PUC. This balloting was completed in early June and the PUC met on June 15-17, 2003, to resolve comments and formulate its recommendations concerning which of this second batch of proposals should be submitted to the membership. The BSSC Board received and accepted the PUC recommendations on June 18.

Ninety-nine new proposals (those submitted to the PUC by mail plus a number of PUC proposals developed at the meeting) were reviewed and voted on by the PUC at a three-day meeting held in San Diego, California, in

June 15-17, 2003. Of these, 84 were accepted by the PUC, many with revisions, and subsequently submitted to the BSSC Board with the recommendation that they be added to the 54 proposals approved earlier and submitted to the BSSC member organizations for ballot. The Board accepted the PUC recommendation and the ballot package (composed of the ballot sheet, proposals, composites of the reformatted Provisions and Commentary, and the comments and responses on each proposal) was sent to the representatives and alternates of the 63 BSSC member organizations on August 1, 2003. Ballots were due October 1.

The member organization votes were tallied and comments were forwarded to the appropriate PUC technical subcommittee chairs in mid-October in preparation for a November meeting of the PUC at which ballot comments were addressed. Given that the contract with FEMA requires delivery of the consensus approved 2003 *Provisions* and *Commentary* in March 2004, another ballot will not be possible; therefore, the BSSC Board authorized the PUC to resolve, if possible, comments on proposals that have passed the membership ballot and to consider any proposals for which comments cannot be resolved as items for reconsideration in the next update cycle.

The PUC met on November 20-21, 2003, to review the proposals for change. Approximately 130 proposals received the required two-thirds affirmative votes; with approximately half of those requiring some revisions in response to comments. On November 22, the PUC chair presented the results to the BSSC Board. The Board addressed two contentious issues at the request of the PUC and accepted the PUC recommendations regarding the changes to be made for the 2003 edition of the *Provisions* and *Commentary*. The final draft is now being assembled for review by the PUC and it will be officially delivered to FEMA by the end of April 2004.

Planning for the next update cycle is beginning and a small task group met on November 19, 2003, to discuss how to structure the next *Provisions* update cycle to adopt ASCE 7 by

reference. It also appears that the PUC will be somewhat smaller in the next cycle and there will be fewer technical subcommittees. Ad hoc issue committees will be appointed on an as-needed basis to address research needs and develop emerging technologies. Coupled with this streamlining, it is anticipated that the next edition of the *Provisions* will be issued in 2008, rather than 2006, to better mesh with the codes and standards development schedules.

CODE RESOURCE DEVELOPMENT AND SUPPORT

In mid-1996, FEMA asked the BSSC to initiate an effort to generate a code resource document based on the 1997 *Provisions* for use by the International Code Council (ICC) in adopting seismic provisions for the first edition of the *International Building Code (IBC)* to be published in 2000. The Code Resource Development Committee (CRDC) appointed to conduct this effort met several times over the next year and the CRDC-developed draft requirements were presented to the ICC's *IBC* Structural Subcommittee in March 1997.

Subsequently, the CRDC met to develop comments on the *IBC* working draft to be submitted to the ICC in preparation for an August 1997 public comment forum. These comments generally reflected actions taken by the PUC in response to comments submitted with the first ballot on the changes proposed for the 1997 *Provisions* as well as CRDC recommendations concerning changes made by the *IBC* Structural Subcommittee in the original CRDC submittal. CRDC representatives attended the August forum to support the CRDC recommendations.

After issuance of the first draft of the *IBC* in November 1997, the CRDC met to prepare "code change proposals" that reflected the final version of the 1997 *Provisions* for submittal in January 1998. The CRDC then met for the last time as a committee in March 1998 to review the compilation of *IBC* code change proposals issued by the ICC and to develop a strategy for supporting the code

change proposals it had developed at an *IBC* public hearing in April. In addition, the *IBC* Structural Subcommittee asked for CRDC input concerning all the seismic-related code change proposals and these comments were summarized and transmitted to the *IBC* group for its consideration.

An eight-member Code Resource Support Committee (CRSC) then was established to support the *Provisions*-based requirements through the remainder of the adoption process and to provide for needed liaison with the 2000 *Provisions* development work. A CRSC Technical Advisory Group (TAG) composed of representatives of the 2000 PUC and the various materials interests also was established to support the CRSC. The first task of the CRSC was to deal with one major issue that arose at the April hearing at which several code change proposals concerning the draft *IBC* (and 1997 *Provisions* based) response modification factors and limits of applicability of certain structural systems were discussed. At the suggestion of a CRDC representative at the hearing, the proponents of those code changes agreed to withdraw their proposals to permit discussion of their technical merit outside the forum of the public hearing process. To this end, the CRSC invited these code change proponents as well as representatives of the various construction industry materials associations to an August 1998 meeting at which the group formulated a consensus opinion on an appropriate series of code change proposals that could be submitted to replace those withdrawn in April. Additional topics also were discussed and a total of 13 code-change proposals were drafted.

In September 1998, the 2000 PUC Executive Committee was briefed on these code-change proposals, most of which were accepted by the PUC as items to be considered during the 2000 update effort; however, five items were deemed to be significant departures from the 1997 *Provisions* and required a vote by the full PUC. This balloting concluded in early October with all items achieving consensus approval. The CRSC then finalized all 13 of its code change proposals and submitted them to the ICC in late October 1998.

In January and February 1999, the CRSC met with its Technical Group to consider the proposed changes to the *International Building Code* seismic provisions that would be debated at March 1999 hearings. The CRSC chair and several member participated in the hearings on behalf of the CRSC.

An *International Residential Code* Task Group established within the CRDC in late-1997 has provided the ICC committee developing the *International Residential Dwelling Code (IRC)* with input concerning seismic requirements reflecting the 1997 *Provisions*, and these requirements generally were reflected in the draft *IRC*. The activities of this task group have paralleled those of the CRDC/CRSC with the *IBC* and representatives attended the *IRC* July 1998 public hearing in Kansas City. At this hearing, agreement was reached on the seismic map to be included in the *IRC*; this map subsequently was prepared for the BSSC by USGS and submitted to the ICC for inclusion in the final draft of the *IRC*. The task group met in February 1999 to review proposed code changes and prepare for the March ICC hearings.

The CRSC chair and several CRSC members represented the group at the joint annual conference of BOCA, ICBO, and SBCCI held in September 1999 in St. Louis. Overall, the CRSC was successful in that almost all challenges to the seismic provisions were decided in favor of the CRSC position and the seismic provisions in both the 2000 *International Building Code* and the *International Residential Code* reflect the 1997 *NEHRP Recommended Provisions*.

In preparation for the ICC hearings to be held in Birmingham, Alabama, in April 2000, the CRSC and its Technical Group reviewed the code changes and met via telephone conference calls in March 2000 to discuss the proposals. The CRSC chair and several other CRSC members attended the hearings. With respect to the *International Building Code*, the CRSC had specific positions on 41 proposals. Of these proposals, 35 were decided in the

direction CRSC favored and two that the CRSC opposed were withdrawn. During the hearings on the *International Residential Code*, the CRSC had specific positions on 12 proposals. Eight of these proposals were decided in favor of CRSC's position and one was withdrawn at CRSC's request.

In late September 2000, NIBS entered into a contract with FEMA to fund further code support work by the BSSC. Thus, the 2001 CRSC was reconstituted to include additional members and two special task groups; one to focus on the *IRC*, and one to focus on the NFPA code. The expanded CRSC and its Technical Advisory Group (TAG) reviewed the proposals for change to the *IBC* and *IRC* in preparation for the hearing held in Portland, Oregon, in late March 2001. During a February 23 conference call, the CRSC formulated its position on the proposed changes to the *IRC*. At a meeting on March 5, with its TAG, the CRSC decided upon its positions on the proposed changes to the *IBC*. The CRSC chair and several CRSC members attended the hearing.

The CRSC's NFPA Task Group members attended meetings of the NFPA Technical Correlating Committee (TCC) and Structures and Construction Committee. In addition, the CRSC representative to the TCC has been appointed by that committee as its representative to the Performance Task Group to the Fundamentals Committee.

The 2001 CRSC met in Denver in July 2001 to review draft code change proposals based on the changes made for the 2000 *Provisions*. As noted above, S. K. Ghosh Associates, Inc., prepared drafts of the *IBC*-related proposals and Kelly Cobeen and Alan Robinson developed the *IRC* proposals. These proposals were then revised in response to CRSC comments and, as directed by the BSSC Board, sent to the BSSC member organizations for comment.

The CRSC met in October 2001 to review the comments received and to address other code-related matters including the need for additional changes identified during work on ASCE 7 and CRSC work on NFPA 5000. CRSC-approved

code changes then were officially submitted to the ICC in November.

Several CRSC members presented an educational workshop on the enforcement implications for code officials of adoption of the *IBC/IRC* at the BOCA Annual Business Meeting in September 2001.

The CRSC initiated its review of those proposals for change to the *IBC* and *IRC* affecting seismic matters in mid-February 2002 in preparation for a mid-March meeting at which the group formulated its official position on these proposals and identified which CRSC members would represent the committee at the ICC hearings scheduled for April 2002. Several members of the CRSC attended the hearings and, overall, the group's positions on specific changes tended to prevail.

In mid-September 2002, the CRSC convened via telephone to review the final action agenda for the ICC Codes Forum to be held in Ft. Worth, Texas, the first week in October. Plans were also made for CRSC representation at the meeting.

In early March, BSSC was informed that a proposed educational workshop on the enforcement implications for code officials of adoption of the *IBC/IRC* had been accepted for presentation at the Ft. Worth meeting and in mid-September the individuals involved in the presentation convened via telephone to refine plans for the presentation.

Several CRSC members attended the ICC Codes Forum in Fort Worth in October 2002. The educational session on *IBC/IRC* code enforcement implications also was conducted twice and was well received. During late 2002, CRSC representatives attended code adoption meetings in Kentucky and South Carolina.

The CRSC met in February 2003 to review already-accepted proposals for change for the 2003 *Provisions* to determine whether any should be submitted as proposals for change for the *International Building Code* or

International Residential Code. The group decided that it would submit only one proposal for change – i.e., one that would change the map for the *International Residential Code* in the central states and the southeast to reduce the area in which substantial seismic requirements would prevail.

The CRSC also has nominated several individuals to represent CRSC/FEMA interests on several technical committees involved in the National Fire Protection Association *NFPA 5000* code change process. At FEMA's request, the CRSC also nominated an individual to represent CRSC/FEMA interests on the NFPA committee responsible for two manufactured housing standards.

The CRSC met in June 2003 in conjunction with the BSSC Annual Meeting and formulated plans for review of proposals in preparation for the ICC hearings in September and for an effort to develop a change proposal for submittal to the ASCE 7 Seismic Task Committee that will present a reformatted version of the ASCE 7 seismic requirements intended to be more user friendly and to reflect the reformatting work done for the 2003 edition of the *NEHRP Recommended Provisions*.

Following individual review and input concerning the proposals for change to the *IBC* and *IRC* affecting the seismic requirements, the CRSC convened via telephone in August to determine the positions to be taken by the CRSC representatives who would attend the hearings. Subsequently, six CRSC members represented the group at the *IBC* portion of the hearings and three, at the *IRC* portion. As has consistently been the case, the positions taken by the CRSC tend to prevail with the relevant ICC committees overseeing the hearings.

In July 2003, a representative of the CRSC participated in a hearing on *IBC* adoption in the state of Tennessee. In addition, cost information developed earlier to show the impact of the 2000 *IBC* seismic requirements on costs of typical buildings over the costs for the same structures constructed under prevailing codes in a number of geographic areas was provided to individuals

in Tennessee. Planning is under way for the development of additional designs that will compare the cost impact of the *IBC* seismic requirements over the prevailing code requirements for typical buildings in the central and southern states.

Development of the code change proposal for ASCE 7 was completed in January and officially submitted to the ASCE 7 Seismic Task Committee. In addition, the CRSC convened in March 2004 to review the public comments on ICC code change proposals. Few of the comments focused on seismic issues; consequently, only two CRSC representatives will attend the ICC meeting in May. CRSC representatives continue to serve on a number of NFPA 5000 technical committees and CRSC participants have been helpful in drafting a proposal on anchorage of manufactured housing to resist earthquake ground motions..

FEMA also has entered into a new contract with NIBS to support the BSSC's codes and standards work through FY 2004 and, through options, through FY 2006. FEMA currently is considering the BSSC proposal for funding for the BSSC's code development and support functions through FY 2004.

INFORMATION DISSEMINATION

The BSSC continues in its efforts to stimulate widespread use of the *Provisions*. In addition to the issuance of a variety of publications that complement the *Provisions*, over the past decade the BSSC has developed materials for use in and promoted the conduct of a series of seminars on application of the *Provisions* among relevant professional associations.

In September 1997, NIBS entered into a 60-month indefinite quantity contract with FEMA for conduct of the BSSC's information dissemination. The first task orders issued under the contract charge the BSSC to increase its capability to respond to requests for technical assistance relating to the *Provisions*,

to increase its capability to provide more general technical assistance and information in a coordinated and proactive manner and using all communication media including its website, to review existing complementary publications and educational seminar materials not already revised in whole or in part to reflect the 1997 *Provisions* and to prepare a plan to bring them into conformance with the substantive content of the 1997 *Provisions* if such is deemed appropriate or to develop different documents aimed at changing audiences, to revise the course materials including the *Guide to Application of the Provisions*, an instructors manual and slide set, and a student manual to reflect the 1997 *Provisions* and the code requirements based on the *Provisions*, to prepare and implement a plan to market the instructional materials and subsequently conduct an ongoing series of instructional (both technical and nontechnical) training seminars on an as-requested basis, to continue to promote and encourage the use of the *Provisions* by the nation's model code organizations and their adoption by local jurisdictions, and to continue to conduct activities to increase the general awareness of the earthquake risks in different regions throughout the country and the need to use local building codes that are substantially equivalent with the *Provisions*.

Because of unanticipated delays in preparation of the new *Guide* and instructional materials, the decision was made in early 2001 that the work should focus instead on the 2000 edition of the *Provisions*. Since that time, the *Guide* document has been developed, finalized, and reviewed by the BSSC subcontractor conducting the project and the instructional materials have been pilot tested in several venues including the 2001 and 2002 Multihazard Building Summer Design Institutes held in July 2001 and 2002 at the Emergency Management Institute.

The final draft of the new *Guide to Application of the 2000 NEHRP Recommended Provisions* was received in autumn 2002 and was sent to the Provisions Update Committee, the group possessing the greatest in-depth understanding of the *Provisions*, and selected BSSC Board members for review. This review was completed

in March 2003 and changes were made in response to reviewer comments. The final draft was then submitted by the BSSC subcontractor in April and the material was pilot tested in various venues (including the Emergency Management Institute's Multihazard Building Design Summer Institute in July-August 2003).

The final copy edit of the *Guide* was completed in October 2003 and an effort was mounted to "extend the life" of the document, originally prepared to reflect the 2000 edition of the *Provisions*, by integrating cross references to the relevant section numbers in the 2003 *Provisions* and by integrating notes that focus on changes that will be made for the 2003 *Provisions* (mention of those proposals that are not approved will be removed before FEMA printing of the document). With the final decisions now made about the 2003 *Provisions*, this effort will be completed by the end of April 2004.

Funded by FEMA in September 2002 was an 18-month effort to develop an up-to-date version of an earlier FEMA publication, *Home Builders' Guide to Seismic-Resistant Construction*, and to update an earlier BSSC publication, *Nontechnical Explanation of the NEHRP Recommended Provisions*, to reflect the 2000/2003 *Provisions*. Work on both these documents is well under way and a briefing on the plans for the *Home Builders'* was presented at the BSSC Annual Meeting in June. These two documents in combination with the *Guide to Application* and associated educational materials provide the resources needed to familiarize a large segment of the building community with the *Provisions*.

In September 2003, FEMA issued an additional task order to fund BSSC information dissemination efforts through FY 2004.

IMPROVING THE SEISMIC SAFETY OF EXISTING BUILDINGS

Guidelines/Commentary Development Project

The 1997 *NEHRP Guidelines for the Seismic Rehabilitation and Commentary* volumes and 1997 map packet (which also include maps referenced in the *NEHRP Recommended Provisions for New Buildings and Other Structures*) are readily available as are two companion volumes – *Planning for Seismic Rehabilitation: Societal Issues* (FEMA 275) and *Example Applications of the NEHRP Guidelines for the Seismic Rehabilitation of Buildings* (FEMA 276).

Case Studies Project

The case studies project was an extension of the multi-year project leading to publication of the *NEHRP Guidelines for the Seismic Rehabilitation of Buildings* and its *Commentary* in late 1997. The project is expected to contribute to the credibility of the *Guidelines* by providing potential users with representative real-world application data and to provide FEMA with the information needed to determine whether and when to update the *Guidelines*. The final report on the project was delivered to FEMA in September 1999 and is now available as FEMA 343, *Case Studies: An Assessment of the NEHRP Guidelines for the Seismic Rehabilitation of Buildings*.

Guidelines Training Seminars

In August 1997, NIBS entered into a contract with FEMA for the design and conduct of a series of technical training seminars to transfer the technology and information contained in the *Guidelines* to structural and architectural engineers (whether in private or government practice, representing organizations both large and small); to local building officials and technical staffs, interested contractors, and mitigation officials, where applicable; and to engineering educators and students in institutions offering seismic design curricula. Conceptually, the seminar curriculum will take the form of a series of modules that will permit it to be adapted for use with a variety of audiences.

The Applied Technology Council, under contract to the BSSC, developed the seminar program

syllabus and other instructional materials. To date, approximately 2000 structural engineers have attended seminars on the *NEHRP Guidelines for the Seismic Rehabilitation of Buildings*. Being conducted for FEMA by the BSSC with the assistance of the Applied Technology Council, two-day seminars have been held in San Diego; Salt Lake City; Portland, Oregon; Los Angeles; Seattle; New York City; Oakland; St. Louis; Charleston, South Carolina; Chicago, Illinois; Sacramento, California; and Washington, D.C.

BSSC MEMBER ORGANIZATIONS
 (* indicates affiliate nonvoting member)

<p>AFL-CIO Building and Construction Trades Department.</p> <p>American Concrete Institute</p> <p>American Consulting Engineers Council</p> <p>American Forest and Paper Association</p> <p>American Institute of Architects</p> <p>American Institute of Steel Construction</p> <p>American Iron and Steel Institute</p> <p>American Society of Civil Engineers</p> <p>American Society of Civil Engineers--Kansas City Chapter</p> <p>American Society of Mechanical Engineers</p> <p>American Welding Society</p> <p>APA - The Engineered Wood Association</p> <p>Applied Technology Council</p> <p>ASHRAE ,Inc.</p> <p>Associated General Contractors of America</p> <p>Association of Engineering Geologists</p> <p>Association of Major City Building Officials</p> <p>Bay Area Structural, Inc.*</p> <p>Brick Industry Association</p> <p>Building Owners and Managers Association International</p> <p>Building Technology, Incorporated*</p> <p>California Geotechnical Engineers Association</p> <p>California Seismic Safety Commission</p> <p>Canadian National Committee on Earthquake Engineering</p> <p>City of Hayward, California*</p> <p>Concrete Masonry Association of California and Nevada</p> <p>Concrete Reinforcing Steel Institute</p> <p>Concrete Reinforcing Steel Institute</p> <p>Division of state Architect (California)</p> <p>Earthquake Engineering Research Institute</p> <p>Felten Engineering Group, Inc.*</p> <p>General Services Administration Seismic Program</p> <p>Hawaii State Earthquake Advisory Board</p> <p>H&H Group, Inc.*</p> <p>HLM Design*</p> <p>Institute for Business and Home Safety</p> <p>Interagency Committee on Seismic Safety in Construction</p> <p>International Code Council</p>	<p>International Masonry Institute</p> <p>LaPay Consulting, Inc.*</p> <p>Masonry Institute of America</p> <p>Metal Building Manufacturers Association</p> <p>Mid-America Earthquake Center</p> <p>National Association of Home Builders</p> <p>National Concrete Masonry Association</p> <p>National Conference of States on Building Codes and Standards</p> <p>National Council of Structural Engineers Associations</p> <p>National Elevator Industry, Inc.</p> <p>National Fire Sprinkler Association</p> <p>National Institute of Building Sciences</p> <p>National Ready Mixed Concrete Association</p> <p>Portland Cement Association</p> <p>Precast/Prestressed Concrete Institute</p> <p>Rack Manufacturers Institute</p> <p>Santa Clara University</p> <p>Square D Company*</p> <p>Steel Deck Institute, Inc.</p> <p>Steel Joist Institute*</p> <p>Structural Engineers Association of California</p> <p>Structural Engineers Association of Central California</p> <p>Structural Engineers Association of Colorado</p> <p>Structural Engineers Association of Illinois</p> <p>Structural Engineers Association of Kentucky</p> <p>Structural Engineers Association of Northern California</p> <p>Structural Engineers Association of Oregon</p> <p>Structural Engineers Association of San Diego</p> <p>Structural Engineers Association of Southern California</p> <p>Structural Engineers Association of Texas</p> <p>Structural Engineers Association of Utah</p> <p>Structural Engineers Association of Washington</p> <p>The Masonry Society</p> <p>U.S. Army CERL</p> <p>Vibration Mountings and Controls*</p> <p>Western States Clay Products Association</p> <p>Western States Structural Engineers Association</p> <p>Wire Reinforcement Institute, Inc.</p>
---	--

BUILDING SEISMIC SAFETY COUNCIL PUBLICATIONS

Available free from the Federal Emergency Management Agency at 1-800-480-2520 (order by FEMA Publication Number). For detailed information about the BSSC and its projects, contact: BSSC, 1090 Vermont Avenue, N.W., Suite 700, Washington, D.C. 20005 Phone 202-289-7800; Fax 202-289-1092; e-mail ctanner@nibs.org

NEW BUILDINGS PUBLICATIONS

The NEHRP (National Earthquake Hazards Reduction Program) Recommended Provisions for Seismic Regulations for New Buildings, 2003 Edition, 2 volumes and maps, FEMA 450 (issued as a CD with only limited paper copies available).

The NEHRP (National Earthquake Hazards Reduction Program) Recommended Provisions for Seismic Regulations for New Buildings, 2000 Edition, 2 volumes and maps, FEMA 368 and 369

Guide to Application of the 1991 Edition of the NEHRP Recommended Provisions in Earthquake Resistant Building Design, Revised Edition, 1995, – new edition to be issued as FEMA 451 in preparation

A Nontechnical Explanation of the NEHRP Recommended Provisions, Revised Edition, 1995, FEMA 99 – new edition in preparation.

Seismic Considerations for Communities at Risk, Revised Edition, 1995, FEMA 83 – new edition expected to be published in late 1999 or early 2000

Seismic Considerations: Apartment Buildings, Revised Edition, 1996, FEMA 152

Seismic Considerations: Elementary and Secondary Schools, Revised Edition, 1990, FEMA 149

Seismic Considerations: Health Care Facilities, Revised Edition, 1990, FEMA 150

Seismic Considerations: Hotels and Motels, Revised Edition, 1990, FEMA 151

Seismic Considerations: Office Buildings, Revised Edition, 1996, FEMA 153

Societal Implications: Selected Readings, 1985, FEMA 84

EXISTING BUILDINGS

NEHRP Guidelines for the Seismic Rehabilitation of Buildings, 1997, FEMA 273

NEHRP Guidelines for the Seismic Rehabilitation of Buildings: Commentary, 1997, FEMA 274

Case Studies: An Assessment of the NEHRP Guidelines for the Seismic Rehabilitation of Buildings, 1999, FEMA 343

Planning for Seismic Rehabilitation: Societal Issues, 1998, FEMA 275

Example Applications of the NEHRP Guidelines for the Seismic Rehabilitation of Buildings, 1999, FEMA 276

NEHRP Handbook of Techniques for the Seismic Rehabilitation of Existing Buildings, 1992, FEMA 172

NEHRP Handbook for the Seismic Evaluation of Existing Buildings, 1992, FEMA 178

An Action Plan for Reducing Earthquake Hazards of Existing Buildings, 1985, FEMA 90

MULTIHAZARD

An Integrated Approach to Natural Hazard Risk Mitigation, 1995, FEMA 261/2-95

LIFELINES

Abatement of Seismic Hazards to Lifelines: An Action Plan, 1987, FEMA 142

Abatement of Seismic Hazards to Lifelines: Proceedings of a Workshop on Development of An Action Plan, 6 volumes:

Papers on Water and Sewer Lifelines, 1987, FEMA 135

Papers on Transportation Lifelines, 1987, FEMA 136

Papers on Communication Lifelines, 1987, FEMA 137

Papers on Power Lifelines, 1987, FEMA 138

Papers on Gas and Liquid Fuel Lifelines, 1987, FEMA 139

Papers on Political, Economic, Social, Legal, and Regulatory Issues and General Workshop Presentations, 1987, FEMA 143

(February 2004)